



SETTEMBRE 2016

Linea Chic

seguici su:



Via dei Falegnami - Zona Industriale
64020 Scerne di Pineto (TE)
Telefono 085.9463013 - 085.9463203 - Fax 085 9461588
www.framasil.it e-mail Info@framasil.it

seguici su:



W W W . F R A M A S I L . I T

W W W . F R A M A S I L . I T

CONDIZIONI GENERALI DI VENDITA

DECORRENZA

Il presente listino scattava ad effetto tutti i precedenti, inoltre non costituisce offerta e può essere modificato anche senza preavviso.

PREZZI E CONDIZIONI DI PAGAMENTO

I prezzi sono quotati al pubblico L.V.A. inclusa e al intendano franco fabbrica. Trascorso l'epoca prevista per il pagamento, la FRAMASIL s.r.l. è autorizzata alla emissione di bolle o sollecito maggiorato delle spese, previa comunicazione al Cliente. In caso di pagamento oltre i tempi previsti, saranno calcolati gli interessi bancari correnti. In caso di mancato pagamento nei tempi previsti, la FRAMASIL s.r.l. deve o recuperare gli eventuali scatti previsti per il tipo di pagamento effettuato, potrà sospendere in tutto o in parte le forniture al Cliente.

CONSEGNA

I termini di consegna vengono computati in giorni lavorativi con decorrenza dal perfezionamento della vendita e sono di diritto prorogati per effetti di avvenimenti non compatibili alla FRAMASIL s.r.l. o a cause di forza maggiore. Sono sempre ammessi consegne parziali.

PRODOTTO

I dati tecnici relativi ai prodotti illustrati nel presente listino sono puramente indicativi. La FRAMASIL s.r.l. si riserva la facoltà di apportare tutte le modifiche tecniche costruttive migliorative del prodotto, senzaobbligo di preavviso. Ciò vale anche per gli elettrodomestici impiegati nel corso delle forniture: essi potranno risultare nelle forme e nell'aspetto diversi dal campione pur nel piena rispetto sostanziale delle caratteristiche di funzionalità.

CONSISTENZA FINITURE

Tutte le finiture potranno subire nel tempo variazioni di colore dovute alla luce, ai vapori e all'invecchiamento. In caso di completamenti, si potranno avere delle differenze di tonalità che comunque tenderanno ad attenuarsi nel tempo. Questo fattore non potrà costituire motivo di contestazione o di reso del prodotto.

ELEMENTI FUORI MISURA

La FRAMASIL s.r.l. si riserva di accettare o meno la realizzazione di fuori misura di notevole difficoltà tecnica, previa invito di un disegno e successiva autorizzazione dal ns. ufficio tecnico. Il prezzo di tali fuori misura sarà stabilito di volta in volta. Si intende che gli elementi fuori misura realizzati su Vs. richiesta, non saranno oggetto di ritiro.

TRASPORTO

La merce viaggia a rischio e pericolo del Committente anche se venduta franco di porto. Il ricevente ha l'obbligo di controllare l'integrità all'arrivo e nel caso fare le dovute contestazioni al Vettore. Nel caso di danni che rendono inutilizzabile la merce è opportuno non rifiutare la merce annotando il fatto sull'apposita bolle di consegna. Con la firma della bolle di consegna, viene espressamente dichiarata la perfetta integrità della merce.

INSTALLAZIONE

La FRAMASIL s.r.l. declina ogni responsabilità per errore o cattiva installazione del prodotto fornito, sia esso di sua fabbricazione o di terzi. La ditta FRAMASIL s.r.l. si ritiene esonerata da qualsiasi responsabilità circa il funzionamento delle apparecchiature e dagli accessori inseriti nei moduli. Per eventuali problemi di funzionamento causati da tali apparecchiature, gli occupanti dovranno rivolgersi al servizio di assistenza della Casa costruttrice e risolvere con essa ogni problema.

RECLAMI ED AZIONI

I vizi e i difetti devono essere denunciati alla FRAMASIL s.r.l. nei termini di legge. Anche nel caso di contestazione i pagamenti non possono essere sospesi. La merce rimane di proprietà della FRAMASIL s.r.l. sino al pagamento totale da parte del Committente.

RESI

Si accettano resi solo se espressamente autorizzati dalla FRAMASIL s.r.l.. Verranno concordate modalità di reintegro e di accredito, solo qualora il reso sia imputabile alla responsabilità della FRAMASIL s.r.l..

SPESE

Sulle bolle o ricevute bancarie verranno addebitate le spese di bolle più le spese bancarie per l'incasso. Per ogni controversia il Foro competente è quello della Ditta Venditrice. Il Cliente, con il solo fatto di conferire l'installazione, si dichiara edotto ed accetta tutte le condizioni di vendita che precedono, salvo espresso patto contrario.

Linea Chic

Cucine Linea Chic (come da catalogo generale)

comprendono di serie:

- vaschetta raccogliocce
- griglie colapiatti inox
- il lavello è da 90 cm., una vasca 3" con gocciolatoio (la foto è puramente indicativa)
- fondo alluminio
- maniglia di serie
- anta vetrina di serie
- cassetti **SLOW MOTION**
- ante **AMMORTIZZATE** con **CERNIERE SGANCIO RAPIDO**
- portaposate (nelle basi con 4 cassette)
- le cornici, anche se fotografate sulle cucine, non sono comprese nel prezzo. (bisogna sempre richiederle a parte e aggiungerle al prezzo).
- i rubinetti, anche se fotografati sulle cucine, non sono compresi nel prezzo. (bisogna sempre richiederli a parte e aggiungerli al prezzo).

MAGGIORAZIONE CAMBIO COMPOSIZIONE

Se si verifica la necessità di cambiare una composizione "tipo" bisogna considerare oltre alle aggiunte del prezzo determinata dal listino, una maggiorazione pari a euro 95,00 di listino.

CONDIZIONI DI PAGAMENTO

Tutti i prezzi sono di listino, IVA e RAEE esclusi

Pagamento tassativo r.b. 30 gg. f.m.

Caratteristiche Modelli

SONIA

ANTA: in nobilitato spess. 18 mm. placcato con carta melaminica bordato 4 lati in PVC a colore.

COLORE: acero, ciliegio orizzontale, bianco.

ANTA VETRO: alluminio.

CASSETTO: in nobilitato spess. 18 mm. placcato con carta melaminica bordato 4 lati in PVC a colore,

cassetto slow motion.

STRUTTURA: bianco, noce scuro, ciliegio, acero.

ZOCCOLO: in PVC h.12 colore bianco, noce scuro, ciliegio, finitura alluminio.

MENSOLONE: spessore 3 cm.



acero



anta vetro



maniglia di serie

N.B. PER I FRONTALI DEL MOD. SONIA LA DITTA NON GARANTISCE PER EVENTUALI PROBLEMI DERIVANTI DAL CATTIVO USO DI ACQUA E VAPORE.

ERIKA

ANTA: in nobilitato spess. 18 mm. placcato con rivestimento melaminico bordato 4 lati in PVC a colore.

COLORE: tranchè bianco, tranchè tabacco, canyon bianco, canyon oak natur, canyon oak grigio.

ANTA VETRO: alluminio.

CASSETTO: in nobilitato spess. 18 mm. placcato con rivestimento melaminico bordato 4 lati in PVC a colore, **cassetto slow motion.**

STRUTTURA: bianco, noce scuro, ciliegio.

ZOCCOLO: in PVC h.12 colore bianco, noce scuro, ciliegio, finitura alluminio.

MENSOLONE: spessore 3 cm.



tranchè tabacco



tranchè bianco



anta vetro



canyon bianco



canyon oak natur



canyon oak grigio



maniglia di serie

Caratteristiche Modelli

ROMINA

ANTA: in MDF spess. 18 mm rivestita in PVC opaco o lucido.

COLORE: bianco lucido, bordeaux lucido, avorio lucido, nero lucido, rovere naturale, rovere wengè, rovere grigio, rovere naturale, oak melinga drak, oak melinga white, rustic, cappuccino lucido, beige lucido, melanzana lucido, rosso ferrari lucido, melinga portuna, rovere scuro, arancio opaco, noce tiepolo, bianco opaco setato, frassinato bianco, moka naturale, tranche, ibisco lucido, noce chiaro, bianco opaco, sand.

ANTA VETRO: in MDF colore anta.

CASSETTO: in MDF spess. 18 mm rivestita in PVC, **cassetto slow motion.**

STRUTTURA: bianco, noce scuro, ciliegio.

ZOCCOLO: in PVC h 12, colore bianco, noce scuro, ciliegio, finitura alluminio.

MENSOLONE: spessore 3 cm.



Bianco lucido K74



Rovere naturale R145



maniglia di serie cm 320 per ante 60-90

maniglia di serie cm 128 per ante 15-30-40-45

N.B. = Per l'esatta tonalità del colore fare riferimento alla cartella colore.

N.B. = colore Rovere naturale R145 e Bianco lucido K74 disponibile in magazzino, tutti gli altri colori consegna in 30 gg.

LUNA

ANTA: in MDF spess. 18 mm rivestita in PVC opaco o lucido.

COLORE: bianco lucido, bordeaux lucido, avorio lucido, nero lucido, rovere naturale, rovere wengè, rovere grigio, rovere naturale, oak melinga drak, oak melinga white, rustic, cappuccino lucido, beige lucido, melanzana lucido, rosso ferrari lucido, melinga portuna, rovere scuro, arancio opaco, noce tiepolo, bianco opaco setato, frassinato bianco, moka naturale, tranche, ibisco lucido, noce chiaro, bianco opaco, sand.

ANTA VETRO: Alluminio

CASSETTO: in MDF spess. 18 mm rivestita in PVC opaco o lucido, **cassetto slow motion.**

STRUTTURA: noce scuro/ciliegio/bianco.

ZOCCOLO: in PVC h 12, colore bianco, noce scuro, ciliegio, finitura alluminio.

MENSOLONE: spessore 3 cm.

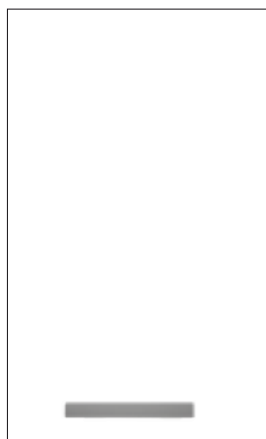

Bianco Lucido K74



Sand



maniglia di serie



N.B. = Per l'esatta tonalità del colore fare riferimento alla cartella colore.

N.B. = colore Sand e Bianco lucido K-74 disponibile in magazzino, tutti gli altri colori consegna in 30 gg.

MANILA

ANTA: anta con telaio in MDF rivestito Alkorcel, pannello in nobilitato rivestito in Alkorcel.

COLORE: bianco o sabbia.

ANTA VETRO: anta telaio in MDF con vetro spess. 4 mm.

CASSETTO: MDF rivestito in Alkorcel, **cassetto slow motion.**

STRUTTURA: bianco.

ZOCCOLO: in PVC h.12, colore bianco, finitura alluminio.



maniglia di serie

Caratteristiche Modelli

GIADA

ANTA: telaio in massello di Alder spess. 21 mm, largo 10 cm, bugna impiallacciata ciliegio.

COLORE: ciliegio.

ANTA VETRO: in massello di Alder con vetro spess. 4 mm.

CASSETTO: in massello di Alder, **cassetto slow motion.**

STRUTTURA: ciliegio.

ZOCCOLO: in PVC h12, colore ciliegio o finitura alluminio.



maniglia di serie

FRANCESCA

ANTA: telaio spess. 24 mm in massello di tulipier. Bugna massello di tulipier.

COLORE: noce scuro.

ANTA VETRO: in massello di tulipier con vetro spess. 4 mm.

CASSETTO: in massello di tulipier, **cassetto slow motion.**

STRUTTURA: noce scuro.

ZOCCOLO: in PVC h 12 colore noce scuro.

CORNICE: in MDF rivestito di carta.



maniglia di serie

MILADY

ANTA: Telaio spess. 24 mm in massello di tiglio con cartella impiallacciata ciliegio.

COLORE: ciliegio.

ANTA VETRO: in massello di tiglio con vetro spess. 4 mm.

CASSETTO: in massello, **cassetto slow motion.**

STRUTTURA: ciliegio.

ZOCCOLO: in PVC h.12, colore ciliegio.

CORNICE: in MDF rivestito di carta.



maniglia di serie

Caratteristiche Modelli

GIULIA

ANTA: telaio in legno massello di Frassino a forte spessore da 26 mm, pannello impiallacciato, finitura laccata a poro aperto colore corda con pannello riquadrato in finitura verde pastello.

COLORE: colore corda con pannello riquadrato in finitura verde pastello.

CASSETTO: in legno massello di Frassino, **cassetto slow motion.**

STRUTTURA: decape corda.

ZOCCOLO: decapè colore corda.

CORNICE: in MDF rivestito di carta.



Maniglia di serie

GAIA

ANTA: in MDF spess. 22 mm.

COLORE: giallo acido opaco, rosso corallo opaco, bordeaux opaco, alluminio opaco, panna opaco, giallo acido, rosso corallo, bordeaux, arancione

vivace, prugna, porpora vivace, grigio canna fucile, senape opaco, blu notte opaco, moka opaco, bianco opaco, alluminio, senape, blu notte, moka, grigio chiaro, tortora scuro, tortora chiaro, cipria, tortora scuro opaco, bianco.

ANTA VETRO: telaio in MDF spess. 22 mm.

CASSETTO: in MDF spess. 22 mm, **cassetto slow motion.**

STRUTTURA: noce scuro, bianco, ciliegio.

ZOCCOLO: noce scuro, bianco, ciliegio, finitura alluminio.

N.B.= la Gaia cucina laccata, consegna in 30 gg.

N.B.= Per l'esatta tonalità del colore fare riferimento alla cartella colore.

Giallo acido opaco ICA 131	Rosso corallo opaco R3001	Bordeaux opaco R3003	Alluminio opaco
Panna opaco	Giallo acido ICA 131	Rosso corallo R3001	Bordeaux R3003
Arancione vivace R2004	Prugna R4007	Porpora vivace R4006	Grigio canna fucile R7015
Senape opaco	Blu notte opaco	Moka opaco R8017	Bianco opaco
Alluminio	Senape	Blu notte	Moka R8017
Grigio chiaro R7047	Tortora scuro ICA 177	Tortora chiaro ICA 119	Cipria N190
Tortora scuro opaco ICA 177	Bianco		



CAPPE D'ARREDAMENTO

CAPPA ELETTA



- **Cappa 60-90 cm**
- **finitura:** acciaio - inox
- **sistema di aspirazione:** aspirante
- **comando:** pulsantiera meccanica (3 velocità)
- **motore:** portata 390 m³/h
- **illuminazione:** 2 x 40 W incandescenza
- **filtri antigrasso:** 2 pannelli alluminio (60 cm)
3 pannelli alluminio (90 cm)
- **flangia uscita aria:** 125-150 mm

N.B.: Cappa DI SERIE

Filtro € 17,00 (Maggiorazione)

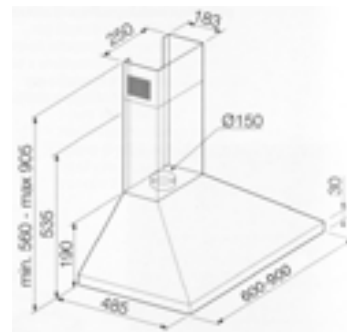

CAPPA LIA



- **Cappa 60 - 90 cm**
- **gruppo:** aspirante

N.B.: Cappa DI SERIE

Filtro € 17,00 (Maggiorazione)

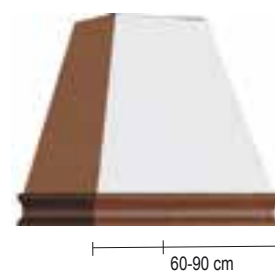

CAPPA QUADRA SMART



- **Cappa 60-90 cm**
- **finitura:** inox/ vetro trasparente
- **sistema di aspirazione:** aspirante
- **comando:** pulsantiera meccanica (3 velocità)
- **motore:** portata 364 m³/h
- **illuminazione:** 2 x 20 W alogene
- **filtri antigrasso:** pannello alluminio
- **flangia uscita aria:** 150 mm

cm 60 € 120,00 (Maggiorazione)

cm 90 € 120,00 (Maggiorazione)

Filtro € 17,00 (Maggiorazione)

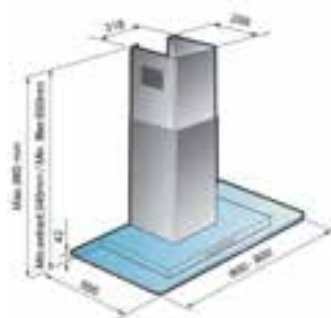

CAPPA MIRAGE 2



- **Cappa 60-90 cm**
- **finitura:** inox/ vetro trasparente
- **sistema di aspirazione:** aspirante
- **comando:** pulsantiera meccanica (3 velocità)
- **motore:** portata 364 m³/h
- **illuminazione:** 2 x 20 W alogene
- **filtri antigrasso:** pannello alluminio
- **flangia uscita aria:** 150 mm

cm 60 € 140,00 (Maggiorazione)

cm 90 € 140,00 (Maggiorazione)

Filtro € 17,00 (Maggiorazione)

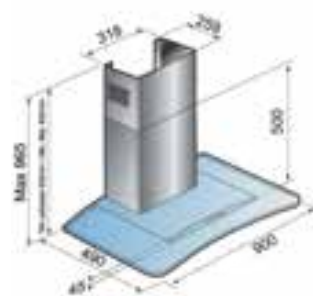

CAPPA EAGLE



- **Cappa 60-90 cm**
- **finitura:** inox
- **sistema di aspirazione:** aspirante
- **comando:** pulsantiera meccanica (3 velocità)
- **motore:** portata 364 m³/h
- **illuminazione:** 2 x 20 W incandescenza
- **filtri antigrasso:** pannello alluminio
- **flangia uscita aria:** 150 mm

cm 60 € 96,00 (Maggiorazione)

cm 90 € 100,00 (Maggiorazione)

Filtro € 17,00 (Maggiorazione)

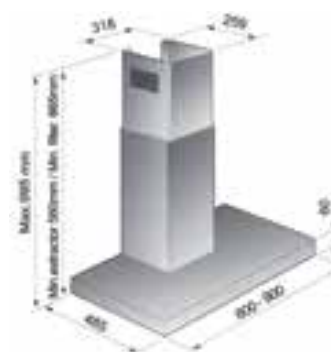

TOP SPESSORE 4 con alzatina



Smart white 01
Alzatina PVC inox



Niagara Rosa
Alzatina a colore



Wraky 6056
Alzatina a colore



Marmo Casablanca 3052 TF
Alzatina a colore



Pietra 70 LQZ
Alzatina a colore



Travertino 1711 CORAL
Alzatina a colore



Bianco 01 TF
Alzatina a colore



Ciliegio 1971
Alzatina a colore



Noce Scuro A24 Opaco
Alzatina a colore

FRIGO CFBD 2450/2 E



Frigo 240 LT.

- Frigorifero doppia porta
- Quattro ripiani in cristallo regolabili in altezza
- Un ripiano in griglia metallizzato nel comparto freezer
- Quattro balconcini controporta trasparenti ad altezze diverse
- Un cassetto per verdure trasparente
- Termostato regolabile
- Porte reversibili
- Volume totale netto: 222 litri
- Volume netto frigorifero: 183 litri
- Volume netto congelatore: 37 litri
- Classe climatica: N/ST
- Classe efficienza energetica: A+

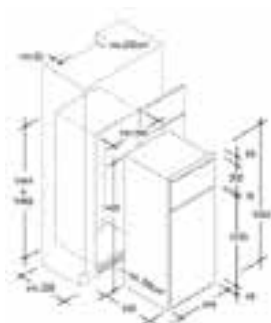

N.B. Elettrodomestico di serie

FRIGO CKBBS 100



Frigo 300 LT.

- Frigorifero combinato a un compressore
- Estetica interna Futura
- Quattro ripiani vetro
- Tre balconcini controporta trasparenti ad altezze diverse
- Un cassetto per verdure trasparente
- Freezer a tre scomparti a cassetto trasparente
- Termostato regolabile
- Porte reversibili
- Volume totale lordo: 281 litri
- Volume netto frigorifero: 190 litri
- Volume netto congelatore: 60 litri
- Classe climatica: N/ST
- Classe efficienza energetica: A+

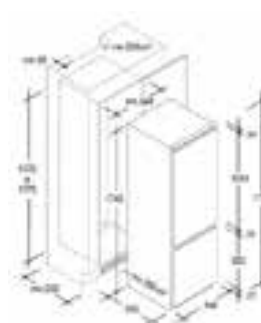

**Maggiorazione
euro 315,00 (listino)**

FRIGO CIO 225 E



- 3 Ripiani in vetro regolabili
- 4 Balconcini controporta ad altezze diverse
- 1 Cassetto trasparente per frutta e verdura
- Sbrinatorio manuale freezer
- Termostato regolabile
- Porta reversibile
- Volume totale lordo: 205 litri
- Volume netto frigorifero: 182 litri
- Volume netto congelatore: 18 litri
- Classe climatica: S T.

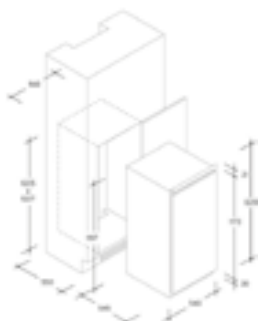

**N.B. di serie compreso solo
nella Composizione N.83**

FORNO STATICO FST 100/6 INOX



- Forno elettrico statico
- Contaminuti
- Porta con doppio vetro termoriflettente
- Grill termostato
- Due griglie, una leccarda
- Sistema di arresto delle griglie
- Cassaforno smaltata A Class Clean
- Pannelli autopulenti a richiesta
- Volume 65 litri
- Potenza massima assorbita: 2,1 kW
- Classe energetica A

**Maggiorazione
euro 70,00 (listino)**

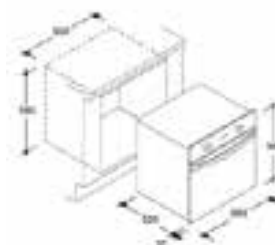

**N.B.: Disponibile nella ver-
sione nero FST 100/6 N**

**N.B. Elettrodomestico di
serie (nero)**

FORNO ELETTRICO MULTIFUNZIONALE FPE 502/6 N



- Forno elettrico Multifunzione
- Contaminuti
- Porta con doppio vetro termoriflettente
- Grill ventilato e termostato
- Due griglie, una leccarda
- Sistema di arresto delle griglie
- Cassaforno smaltata A Class Clean
- Pannelli autopulenti a richiesta
- Volume 65 litri
- Potenza massima assorbita: 2,1 kW
- Classe energetica A

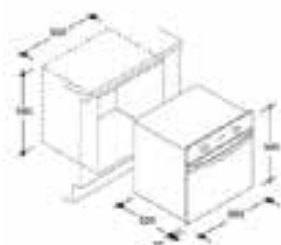

**Maggiorazione
euro 136,00 (listino)**

FORNO ELETTRICO MULTIFUNZIONALE FPE 52/6XV



- Forno elettrico multifunzione
- Funzioni disponibili: 5
- Contaminuti con segnale acustico
- Nuova Controporta in cristallo ad alto isolamento
- Grill ventilato e termostato
- Due griglie, una leccarda
- Sistema di arresto delle griglie
- Cassaforno smaltata A Class Clean
- Pannelli autopulenti a richiesta
- Volume 65 litri
- Potenza massima assorbita: 2,1 kW
- Classe energetica A

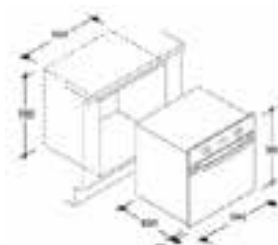

**Maggiorazione
euro 190,00 (listino)**

PIANO COTTURA CLG 64/SPX



- Piano cottura con quattro fuochi gas.
- Accensione elettronica a manopola.
- Doppia griglia
- Piano monoscocca
- Due bruciatori semirapidi
- Un bruciatore rapido
- Un bruciatore ausiliario
- Valvola di sicurezza Sicurflame (interrompe il gas in caso di spegnimento accidentale della fiamma)
- Potenza sviluppata dai bruciatori: 7,1 kW

N.B. Elettrodomestico di serie

N.B.: Su questo modello il coperchio non è previsto.

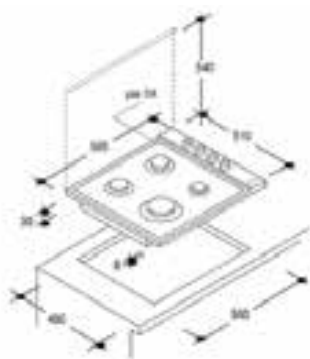

PIANO COTTURA CPG 75/SPX



- Piano cottura da 75 cm.
- Cinque fuochi gas.
- Accensione elettronica a manopola
- Nuovo Piano mono scocca , griglia tripla, un bruciatore ultrarapido, due bruciatori rapidi, un bruciatore semirapido, un bruciatore ausiliario
- Valvola di sicurezza Sicurflame (interrompe il gas in caso di spegnimento accidentale della fiamma)
- Potenza totale sviluppata: 11,25 kW

N.B.: Su questo modello il coperchio non è previsto.

Maggiorazione euro 173,00 (listino)

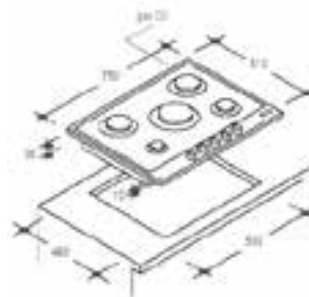

PIANO A INDUZIONE CI640CBA/1



PIANO A INDUZIONE BASSO ASSORBIMENTO MAX. 3 KW

- Comandi elettronici touch
- 4 Zone di cottura:
 - 3 zone diametro 180mm (2 - 1.5 kw, 1 - 2.0 kw)
 - 1 zone diametro 210mm (2,0 kw)
- Sistema ECC (gestione sincrona degli assorbimenti)
- Spia di accensione
- Contaminuti digitale con timer fine cottura
- Sicurezza bambini
- 9 Livelli di potenza
- Potenza massima assorbita: 3,0 kW

Maggiorazione euro 383,00 (listino)

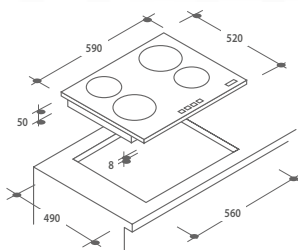

LAVASTOVIGLIE CDI 1L 38-02



- Lavastoviglie elettronica 12 coperti. Led.
- Capacità: 13 coperti
- Consumo acqua: 11 litri
- Silenziosità: 53 dB(A)
- Elettronica Led
- Programmatore di partenza fino a 9h
- 6 programmi
- Speciale Igienizzante 75°C
- Rapido 29'
- Mezzo carico automatico
- Cesto superiore XL
- Classe di efficienza energetica: A+
- Classe di efficienza lavaggio: A
- Classe di efficienza asciugatura: A

Maggiorazione euro 590,00 (listino)

N.B. Inserimento lavastoviglie

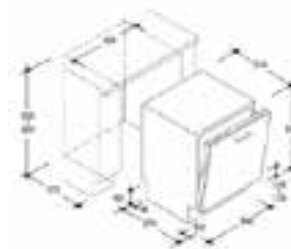

FORNO ELETTRICO A MICROONDE MIC 201 EX



MIC 201 EX
FORNO ELETTRICO A MICROONDE DA INCASSO - PENSILE A COLONNA

- 5 livelli di potenza (max 800W)
- Contaminuti elettronico con segnale sonoro di fine cottura
- 8 Cotture rapide preimpostate
- 3 Tipi di cottura: microonde, grill, microonde+grill
- Griglia a due livelli
- Cavità in acciaio inox
- Scongelo automatico
- Piatto rotante di diametro 245 mm
- Volume 20 litri
- Potenza massima assorbita: 2,25 kW

(Di serie compreso solo nella composizione N.82.)

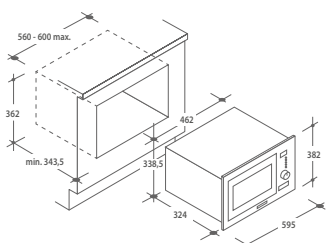

FRIGO BD 2422



- Doppia porta**
- Capacità totale: 220 litri (178 lt frigo + 42 lt congelatore)
 - **Classe di efficienza: A+**
 - Sistema di raffreddamento statico per il frigorifero
 - Sistema di raffreddamento statico per il freezer

Maggiorazione euro 340,00 (listino)

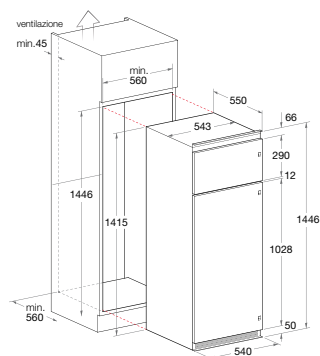

FRIGO BCB 7030 AA



- Dimensioni: H 177 L 54 P 54,5
- Capacità netta totale: 275 litri (195 lt frigo + 80 lt freezer)
- **Classe di efficienza energetica A+**
- Sistema di raffreddamento statico per il frigorifero
- Sistema di raffreddamento statico per il freezer
- 4 ripiani in cristallo
- Fresh crisper
- 1 bacinella ghiaccio

Maggiorazione euro 430,00 (listino)

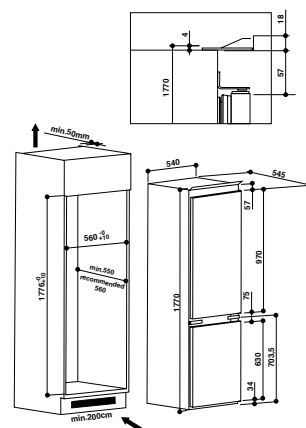

FRIGO BSZ 2333



- Frigo MONOPORTA**
- Capacità totale 194 litri (178 l frigo + 16 l congelatore)
 - Classe di efficienza: A++
 - Protezione Hygiene Advance
 - Sistema di raffreddamento statico per il frigorifero
 - Sistema di raffreddamento statico per il freezer
 - 3 ripiani in vetro
 - 1 bacinella ghiaccio

Maggiorazione euro 275,00 (listino)

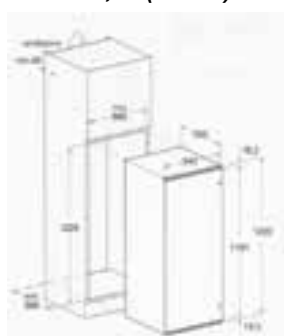

FORNO 3 AF 534 H IX HA



- Manopole esterne
- **6 funzioni: 5 funzioni tradizionali + 1 sistema di pulizia**
- Pulizia Diamond clean
- Cavità da 71 lt
- Classe di efficienza energetica A

Maggiorazione euro 336,00 (listino)

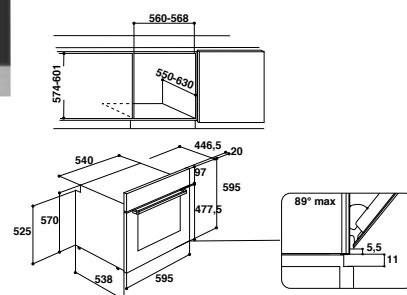

FORNO FA 3530 H IX HA



- Manopole esterne
- **6 funzioni: 5 funzioni tradizionali + 1 sistema di pulizia**
- Pulizia Diamond clean
- Cavità da 66 lt
- Classe di efficienza energetica A

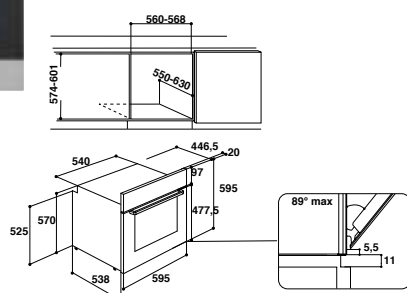

Maggiorazione euro 288,00 (listino)

FORNO FA 5834 H IX HA



- Manopole esterne
- **9 funzioni: 8 funzioni tradizionali + 1 sistema di pulizia**
- Pulizia Diamond clean
- Cavità da 71 lt
- Classe di efficienza energetica A

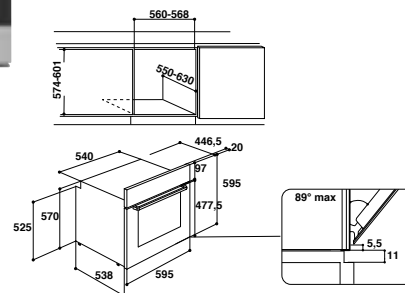

Maggiorazione euro 400,00 (listino)

FORNO FT 850.1 (AV) HA S



Multifunzione 7

- Ventilazione tangenziale di raffreddamento
- Terzo vetro porta forno
- Leccarda profonda
- Orologio analogico inizio-fine cottura
- Classe d'efficienza energetica A

A

**Maggiorazione
euro 499,00 (listino)**

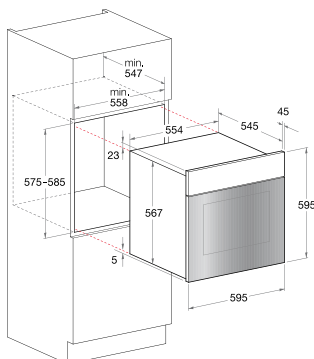

FORNO MICROONDE MWHA 222.1 X



MICROONDE CON GRILL

- Volume utile 25 lt
- 3 combinazioni di cottura: microonde a 5 livelli di potenza, grill, grill + microonde
- 8 funzioni di cottura automatiche
- Programmatore elettronico con segnale di fine cottura
- Sicurezza bambini

Inox

**Maggiorazione
euro 153,00 (listino)**

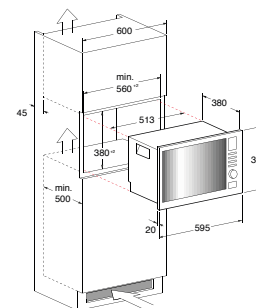

PIANO COTTURA PCN 752 TEX



- 5 fuochi gas di cui 1 tripla corona
- Accensione elettronica sottomanopola
- Valvola di sicurezza gas
- 3 griglie smaltate
- Possibilità di inserimento nel vano dei piani da 60 cm



**Maggiorazione
euro 320,00 (listino)**

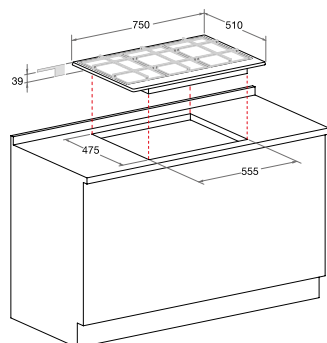

PIANO COTTURA PCN 752 IX



- 5 fuochi gas
- Accensione elettronica sottomanopola
- Valvola di sicurezza gas
- 3 griglie smaltate
- Possibilità di inserimento nel vano dei piani da 60 cm

**Maggiorazione
euro 275,00 (listino)**

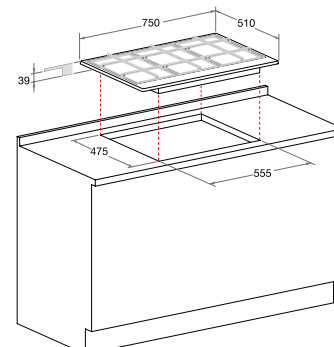

ELETTRODOMESTICI HOTPOINT ARISTON

PIANO COTTURA PCN 642 IX HA



- 4 fuochi gas
- Accensione elettronica sottomanopola
- Valvola di sicurezza gas
- 2 griglie smaltate

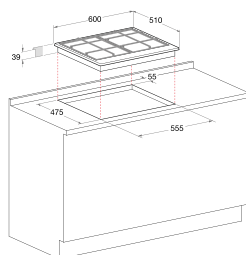

**Maggiorazione
euro 240,00 (listino)**

PIANO COTTURA PC 640 T (AV) R HA



- 4 fuochi gas di cui 1 tripla corona
- Accensione elettronica sottomanopola
- Valvola di sicurezza gas
- 2 griglie ribaltabili smaltate

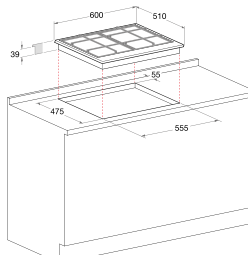

**Maggiorazione
euro 252,00 (listino)**

PIANO COTTURA PC 750 T (AV) R



- Piano cottura da 75cm
- 5 fuochi gas
- Accensione elettronica ad una mano
- Valvola di sicurezza
- 3 griglie smaltate
- Possibilità di inserimento nel vano dei piani da 60cm

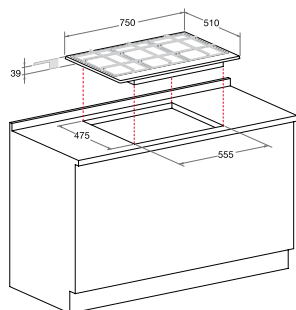

**Maggiorazione
euro 320,00 (listino)**

PIANO COTTURA PKL 752 UIX



- PIANO COTTURA DA 75 CM
- 5 fuochi gas di cui 1 tripla corona
- Accensione elettronica sottomanopola
- Valvola di sicurezza gas
- 3 griglie smaltate
- Possibilità di inserimento nel vano dei piani da 60 cm

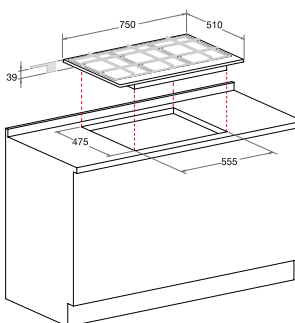

**Maggiorazione
euro 339,00 (listino)**

LAVASTOVIGLIE LTB 4 B 019 EU



- Lavastoviglie a scomparsa totale da 60 cm
- Nuovi cesti
- Potenza sonora: 49 dB (A)
- Capacità 13 coperti
- 4 programmi di lavaggio
- Programmi speciali: Intensivo, Normale
- Visualizzazione mancanza sale, mancanza brillante
- Cesto superiore regolabile Lift-Up
- Sistema di sicurezza Overflow
- Sistema di installazione Fast Fix
- Classe di efficienza energetica: A+
- Consumo acqua ciclo standard: 11 l

Maggiorazione euro 603,00 (listino)

N.B. Inserimento lavastoviglie

FRIGO IND 2412 D



Frigo-Congelatore

- Capacità totale lorda: 226 litri
- Capacità reparto frigorifero: 184 litri
- Capacità reparto freezer: 42 litri
- Classe di efficienza: A+
- Sistema di raffreddamento statico
- Porte reversibili
- Apertura porte a destra

Disponibile anche la versione con apertura porte a sinistra IN D 2412 S

Maggiorazione euro 153,00 (listino)

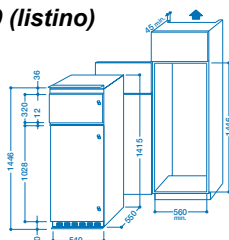

FRIGO B18 A1 D/I



Dimensioni: H 177 L 54 P 54,5 cm

Classe di efficienza energetica **A+**

4 ripiani cristallo

Capacità reparto frigorifero: 195 lt

Capacità reparto freezer: 80 lt

Sistema di raffreddamento statico

Disponibile con aperture porte

a sinistra: B 18 A1 D S/I

Cod. F093231 - EAN 8007842932317

Maggiorazione euro 233,00 (listino)

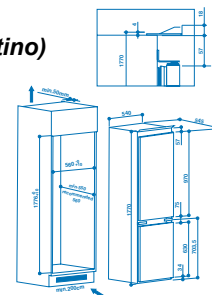

FRIGO IN SZ 2312



Frigorifero con freezer interno

- Efficienza energetica: A+
- Ripiani in vetro
- Porte reversibili
- Capacità totale lorda: 194 litri (178 lt frigo + 16 lt freezer)
- Sistema di raffreddamento statico
- Apertura porte a destra

Maggiorazione euro --- (listino)



FORNO FIM 832 JK A IX (PL)



Multichef con 8 programmi

Programmatore elettronico inizio/fine cottura

Guide telescopiche

Ventilazione tangenziale di raffreddamento

Manopole flat

Classe energetica: A

Cavità facile da pulire

Maggiorazione euro 278,00 (listino)

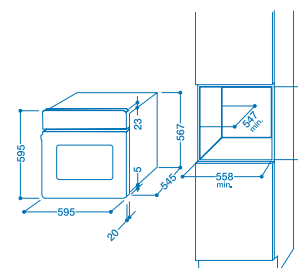

FORNO FIM 51 KA IX S



Estetica Advance

- Forno elettrico multifunzione con 5 programmi di cottura
- Contaminuti
- Cavità facile da pulire
- Classe di efficienza: A
- Ventilazione tangenziale di raffreddamento
- Doppio vetro porta forno
- Luce interna
- 1 griglia e 1 leccarda

Maggiorazione euro 172,00 (listino)

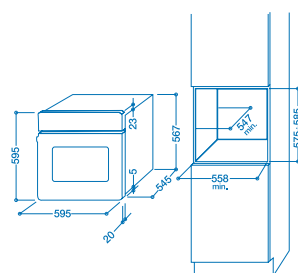

FORNO IFG 51 K A BK S



Estetica vetro Prime Glass
 Multifunzione con 5 programmi
 Contaminuti
 Ventilazione tangenziale di raffreddamento
 Classe energetica: A
 Cavità facile da pulire

**Maggiorazione
 euro 227,00 (listino)**

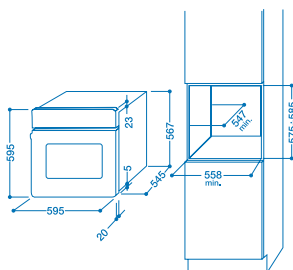

FORNO FIM 51 K A BK S



Estetica Advance
 - Forno elettrico multifunzione con 5 programmi di cottura
 - Contaminuti
 - Cavità facile da pulire
 - Classe di efficienza: A
 - Ventilazione tangenziale di raffreddamento
 - Doppio vetro porta forno
 - Luce interna
 - 1 griglia e 1 leccarda

**Maggiorazione
 euro 156,00 (listino)**

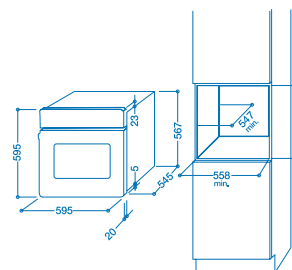

PIANO COTTURA PIM 750 ASTIX



Estetica advance
 - Piano di cottura da 70 cm
 - 5 fuochi gas di cui 1 tripla corona
 - Accensione elettronica
 - Safe flame: Sicurezza gas
 - Bruciatori smaltati
 - 3 griglie smaltate
 - Predisposizione coperchio vetro
 - Possibilità di inserimento nel vano da 60 cm

**Maggiorazione
 euro 192,00 (listino)**

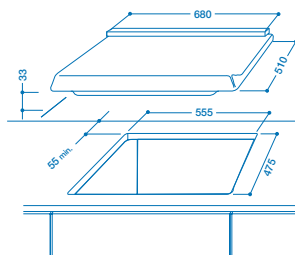

PIANO COTTURA PIM 750 AS IX



Estetica advance
 - Piano di cottura da 70 cm
 - 5 fuochi gas
 - Accensione elettronica
 - Safe flame: Sicurezza gas
 - Bruciatori smaltati
 - 3 griglie smaltate
 - Predisposizione coperchio vetro
 - Possibilità di inserimento nel vano da 60 cm

**Maggiorazione
 euro 163,00 (listino)**

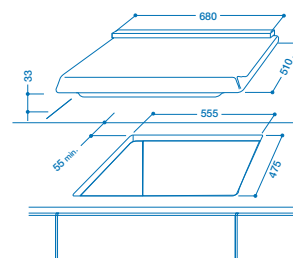

PIANO COTTURA PIM 640 AS IX



Estetica advance

- Piano di cottura da 60 cm
- 4 fuochi gas
- Accensione elettronica
- Safe flame: Sicurezza gas
- Bruciatori smaltati
- 2 griglie smaltate
- Predisposizione coperchio vetro

**Maggiorazione
euro 92,00 (listino)**

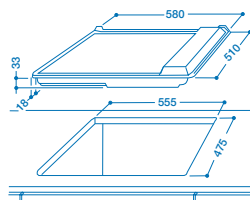

PIANO COTTURA VIA 640.1 C



PIANO COTTURA INDUZIONE DA 60 CM

- 4 spie di calore residuo
- Limitatore di potenza: possibilità di impostare la potenza di assorbimento a: 2,5 kW, 4 kW, 6 kW o 7 kW
- Potenza massima: 7 kW
- Comandi touch control
- Timer fine cottura

NOVITÀ

**Maggiorazione
euro 352,00 (listino)**

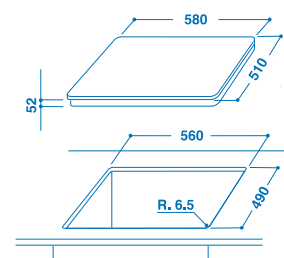

LAVASTOVIGLIE DIF 14 B 1 EU



NOVITÀ

Energy Label: A+AA

13 coperti

4 programmi di lavaggio

Nuovi cesti con Lift-up: +3,5 cm in altezza

Cruscotto led

Sistema di sicurezza Overflow

Nuovo kit d'installazione Extra Fix

**Maggiorazione
euro 495,00 (listino)**

N.B. Inserimento lavastoviglie

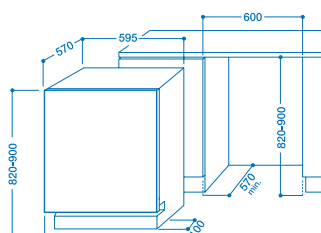

FORNO MICROONDE MWI 122.1 X



Elektronico con grill

10 programmi di cottura

Programmatore elettronico con segnale di fine cottura

Display digitale

5 livelli di potenza

Volume utile: 20 lt

Installabile a colonna

**Maggiorazione
euro --- (listino)**

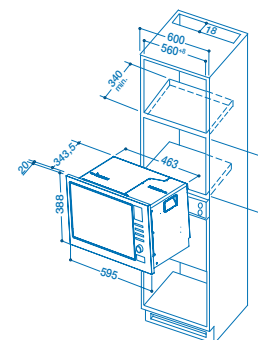

LAVELLI "3 POLLICI"

LAVELLO 86 x 50 - 1 vasca



di serie

versione dx

Lavello 1 vasca con gocciolatoio inox prelucidato

- dimensioni: 860x500 mm
- profondità vasca: 150 mm
- foro incasso: 840x480
- base: 450
- disponibili: versione dx - sx

LAVELLO 86 x 50 - 2 vasche



a richiesta

**Maggiorazione
€ 60,00 (listino)**

Lavello 2 vasche inox prelucidato

- dimensioni: 860x500 mm
- profondità vasca: 150 mm
- foro incasso: 840x480
- base: 900

LAVELLO 116 x 50 - 2 vasche



versione sx

a richiesta

**Maggiorazione
€ 74,00 (listino)**

Lavello 2 vasche con gocciolatoio inox prelucidato

- dimensioni: 1160x500 mm
- profondità vasca: 150 mm
- foro incasso: 1140x480
- base: 900
- disponibili: versione dx - sx

LAVELLI "3 POLLICI"

LAVELLO 86 x 50 - 1 vasca ATLANTIC



a richiesta

**Maggiorazione
€ 117,00 (listino)**

versione dx

Lavello 1 vasca con gocciolatoio inox prelucidato

- dimensioni: 860x500 mm
- profondità vasca: 170 mm
- foro incasso: 840x480
- base: 450
- disponibili: versione dx - sx

LAVELLO 86 x 50 - LV/1 - 1 vasca ATLANTIC



PL0861

a richiesta

**Maggiorazione
€ 191,00 (listino)**

solo colore Avena

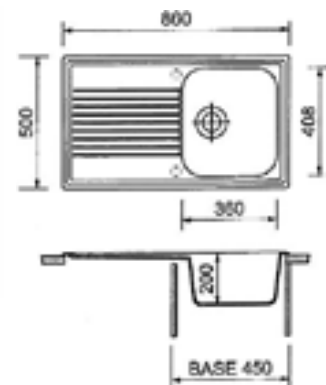

Base da 45 - Foro su top: 840x480 mm

LAVELLO 86 x 50 - 2 vasche ATLANTIC



a richiesta

**Maggiorazione
€ 143,00 (listino)**

Lavello 2 vasche inox prelucidato

- dimensioni: 860x500 mm
- profondità vasca: 170 mm
- foro incasso: 840x480
- base: 900

LAVELLO 86 x 50 - LV/2 - 2 vasche ATLANTIC



PL0862

a richiesta

**Maggiorazione
€ 216,00 (listino)**

solo colore Avena

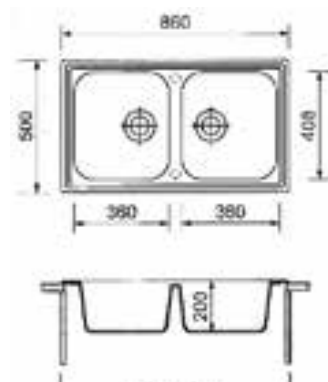

Base da 90 - Foro su top: 840x480 mm

LAVELLO 116 x 50 - 2 vasche ATLANTIC



versione sx

a richiesta

**Maggiorazione
€ 162,00 (listino)**

Lavello 2 vasche con gocciolatoio inox prelucidato

- dimensioni: 1160x500 mm
- profondità vasca: 170 mm
- foro incasso: 1140x480
- base: 900
- disponibili: versione dx - sx

LAVELLO 116 x 50 - LV/2 - 2 vasche ATLANTIC



PL1162

a richiesta

**Maggiorazione
€ 218,00 (listino)**

solo colore Avena

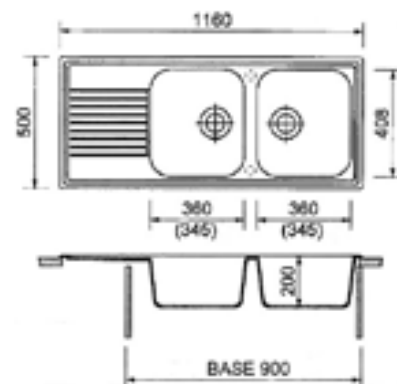

Base da 90 - Foro su top: 1140x480 mm



Colori Ante disponibili per mod. Erika



Colori Top spess. 4 cm.



Maniglie

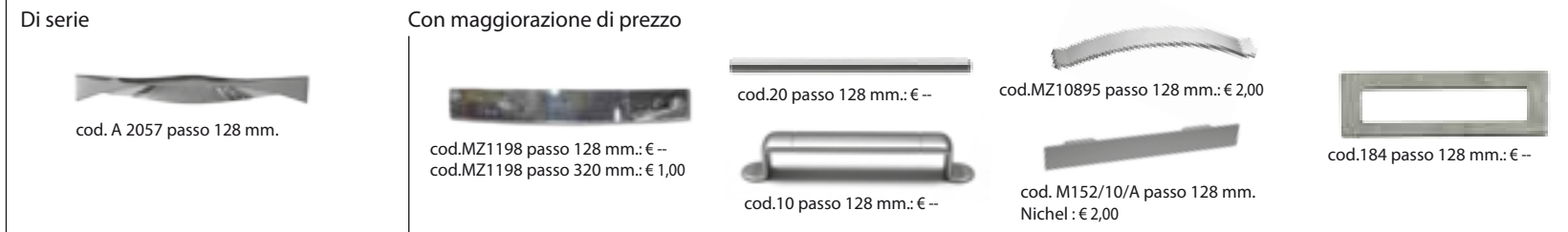



Colori Ante disponibili per mod. Erika



tranchè tabacco



tranchè bianco



canyon bianco



canyon oak natur



canyon oak grigio

Colori Top spess. 4 cm.



travertino 1711 coral



marmo 3052 tf

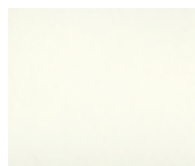

bianco 01 tf



noce scuro a 24



pietra 70 lqz



ciliegio 1971 tf



smart white 01



wraky 6056



rosa niagara

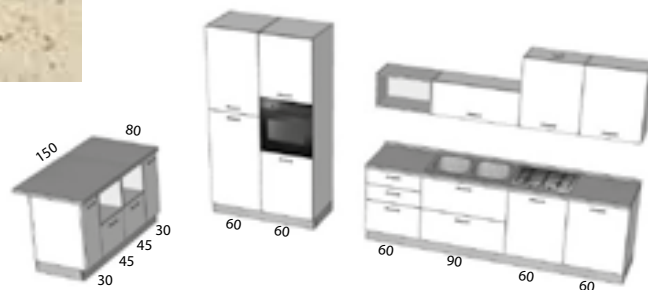

Maniglie

Di serie



cod. A 2057 passo 128 mm.

Con maggiorazione di prezzo



cod.MZ1198 passo 128 mm.: € --
cod.MZ1198 passo 320 mm.: € 1,00



cod.20 passo 128 mm.: € --



cod.10 passo 128 mm.: € --



cod.MZ10895 passo 128 mm.: € 2,00



cod. M152/10/A passo 128 mm.
Nichel : € 2,00



cod.184 passo 128 mm.: € --



Colori Ante disponibili per mod. Erika



Colori Top spess. 4 cm.



Maniglie

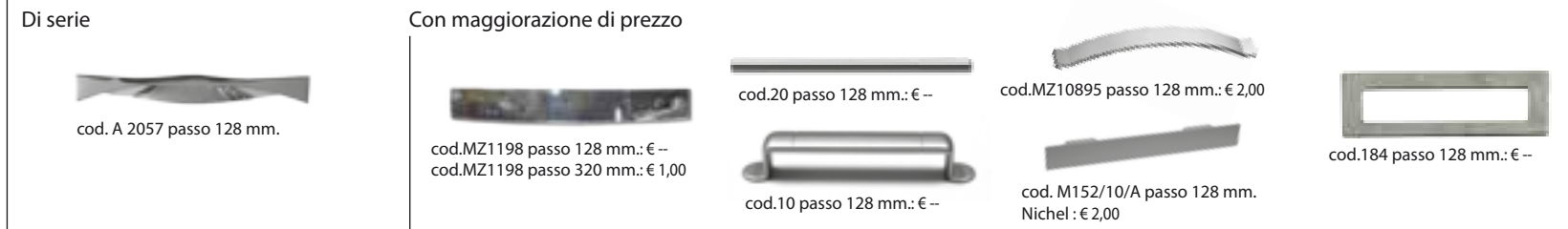



Colori Ante disponibili per mod. Erika



tranchè tabacco



tranchè bianco



canyon bianco



canyon oak natur



canyon oak grigio

Colori Top spess. 4 cm.



travertino 1711 coral



marmo 3052 tf

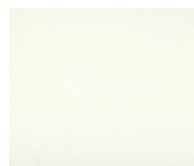

bianco 01 tf



noce scuro a 24



pietra 70 lqz



ciliegio 1971 tf



smart white 01



wraky 6056



rosa niagara

Maniglie

Di serie



cod. A 2057 passo 128 mm.

Con maggiorazione di prezzo



cod.MZ1198 passo 128 mm.: € --
cod.MZ1198 passo 320 mm.: € 1,00



cod.20 passo 128 mm.: € --



cod.10 passo 128 mm.: € --



cod.MZ10895 passo 128 mm.: € 2,00



cod. M152/10/A passo 128 mm.
Nichel : € 2,00



cod.184 passo 128 mm.: € --



Colori Ante disponibili per mod. Sonia



acero



ciliegio



bianco

Colori Top spess. 4 cm.



travertino 1711 coral



marmo 3052 tf



bianco 01 tf



noce scuro a 24



pietra 70 lqz



ciliegio 1971 tf



smart white 01



wraky 6056



rosa niagara

Maniglie

Di serie



cod.20 passo 128 mm.

Con maggiorazione di prezzo



cod.MZ1198 passo 128 mm.: € --
cod.MZ1198 passo 320 mm.: € 5,00



cod. A 2057 passo 128 mm.: € 3,00



cod.10 passo 128 mm.: € --



cod.MZ10895 passo 128 mm.: € 5,00



cod. M152/10/A passo 128 mm.
Nichel: € 7,00



cod.184 passo 128 mm.: € --



Colori Ante disponibili per mod. Sonia



acero



ciliegio



bianco

Colori Top spess. 4 cm.



travertino 1711 coral



marmo 3052 tf

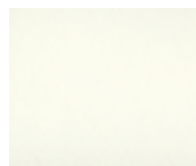

bianco 01 tf



noce scuro a 24



pietra 70 lqz



ciliegio 1971 tf



smart white 01



wraky 6056



rosa niagara

Maniglie

Di serie



cod.20 passo 128 mm.

Con maggiorazione di prezzo



cod.MZ1198 passo 128 mm.: € --
cod.MZ1198 passo 320 mm.: € 5,00



cod. A 2057 passo 128 mm.: € 3,00



cod.10 passo 128 mm.: € --



cod.MZ10895 passo 128 mm.: € 5,00



cod. M152/10/A passo 128 mm.
Nichel: € 7,00



cod.184 passo 128 mm.: € --



Colori Ante disponibili per mod. Erika



Colori Top spess. 4 cm.



Maniglie

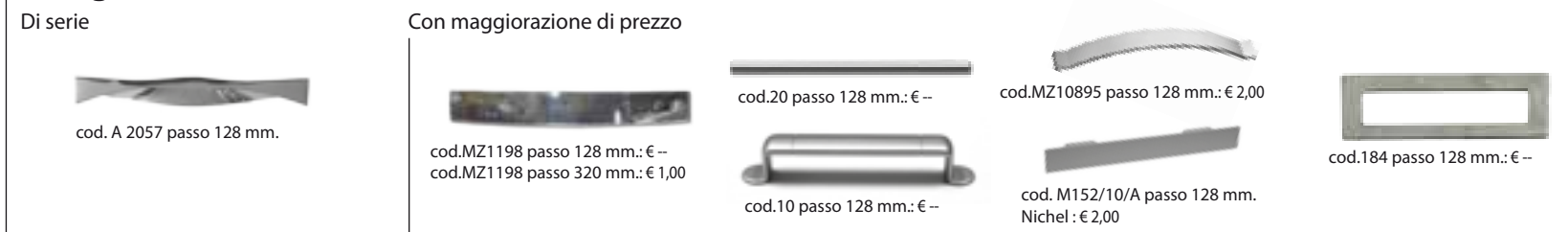



Colori Ante disponibili per mod. Sonia



acero



ciliegio



bianco

Colori Top spess. 4 cm.



travertino 1711 coral



marmo 3052 tf

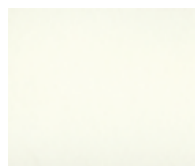

bianco 01 tf



noce scuro a 24



pietra 70 lqz



ciliegio 1971 tf



smart white 01



wraky 6056



rosa niagara

Maniglie

Di serie



cod.20 passo 128 mm.

Con maggiorazione di prezzo



cod.MZ1198 passo 128 mm.: € --
cod.MZ1198 passo 320 mm.: € 5,00



cod. A 2057 passo 128 mm.: € 3,00



cod.10 passo 128 mm.: € --



cod.MZ10895 passo 128 mm.: € 5,00



cod. M152/10/A passo 128 mm.
Nichel: € 7,00



cod.184 passo 128 mm.: € --



Colori Ante disponibili per mod. Luna



Colori Top spess. 4 cm.

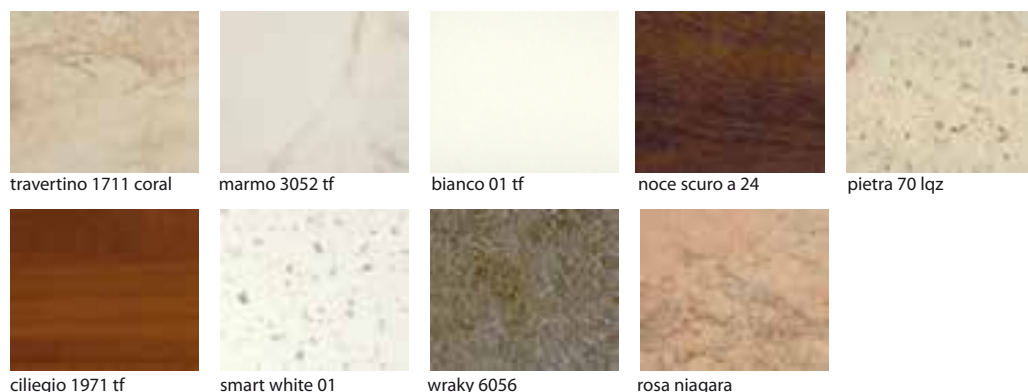

Maniglie





Colori Ante disponibili per mod. Erika



Colori Top spess. 4 cm.



Maniglie

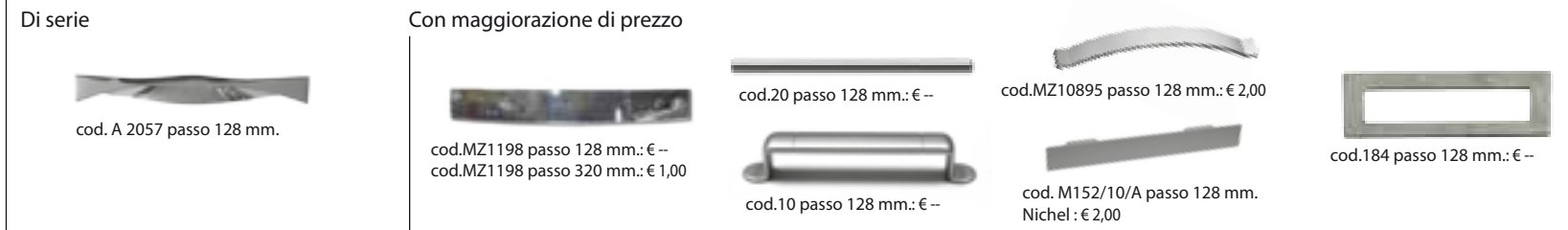



Colori Ante disponibili per mod. Romina

bianco lucido K-74	bordeaux lucido K-137	avorio lucido K-121	nero lucido k-140	cappuccino lucido K-138	beige lucido IHC-65	melanzana lucido K-144	rosso ferrari lucido R-153	ibisco lucido
rovere naturale I-78	rovere wengè I-103	rovere grigio R-195	rovere naturale R-145	melinga portuna R-160	rovere scuro R-146	arancio opaco A-100	noce tiepolo R-159	noce chiaro H-133
sand	oak melinga drak R-161	oak melinga white R-162	rustic	bianco opaco setato R-141	frassinato bianco A-31	moka naturale RIF 32	tranche A183	bianco opaco A-32

Colori Top spess. 4 cm.

travertino 1711 coral	marmo 3052 tf	bianco 01 tf	noce scuro a 24	pietra 70 lqz
ciliegio 1971 tf	smart white 01	wraky 6056	rosa niagara	

Maniglie

Di serie	Con maggiorazione di prezzo			
cod.MZ1198 passo 128 mm. cod.MZ1198 passo 320 mm.	cod. M152/10/A passo 128 mm. Nichel : € 1,00	cod.10 passo 128 mm.: € --	cod. A 2057 passo 128 mm.: € --	cod.MZ10895 passo 128 mm.: € 1,00
			cod.20 passo 128 mm.: € --	cod.184 passo 128 mm.: € 5,00



Colori Ante disponibili per mod. Gaia

Colori Top spess. 4 cm.

N.B.: La Gaia (cucina laccata) consegna in 30 gg.



Colori Ante disponibili per mod. Manila



Sabbia



Bianco

Colori Top spess. 4 cm.



travertino 1711 coral



marmo 3052 tf

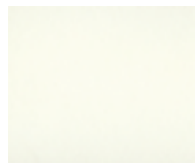

bianco 01 tf



noce scuro a 24



pietra 70 lqz



ciliegio 1971 tf



smart white 01



wraky 6056



rosa niagara

Maniglie

Di serie



cod. H126/1 passo 128 mm.
Cromato lucido

Con maggiorazione di prezzo



cod.MZ1198 passo 128 mm.: € --
cod.MZ1198 passo 320 mm.: € --



cod.10 passo 128 mm.: € --



cod. A 2057 passo 128 mm.: € --



cod.20 passo 128 mm.: € --



cod.MZ10895 passo 128 mm.: € --



cod.184 passo 128 mm.: € --



Colori Ante disponibili per mod. Erika



tranchè tabacco



tranchè bianco



canyon bianco



canyon oak natur



canyon oak grigio

Colori Top spess. 4 cm.



travertino 1711 coral



marmo 3052 tf

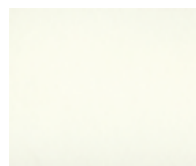

bianco 01 tf



noce scuro a 24



pietra 70 lqz



ciliegio 1971 tf



smart white 01



wraky 6056



rosa niagara

Maniglie

Di serie



cod. A 2057 passo 128 mm.

Con maggiorazione di prezzo



cod.MZ1198 passo 128 mm.: € --
cod.MZ1198 passo 320 mm.: € 1,00



cod.20 passo 128 mm.: € --



cod.10 passo 128 mm.: € --



cod.MZ10895 passo 128 mm.: € 2,00



cod. M152/10/A passo 128 mm.
Nichel : € 2,00



cod.184 passo 128 mm.: € --



Colori Ante disponibili per mod. Luna



Colori Top spess. 4 cm.

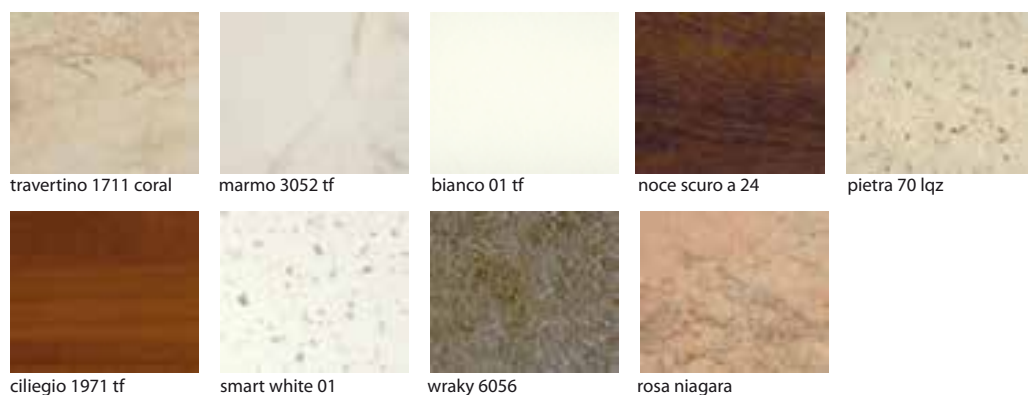

Maniglie



N.B.: Colore Sand e Bianco lucido K-74 disponibile in magazzino, tutti gli altri colori consegna in 30 gg.



Colori Ante disponibili per mod. Erika



Colori Top spess. 4 cm.



Maniglie

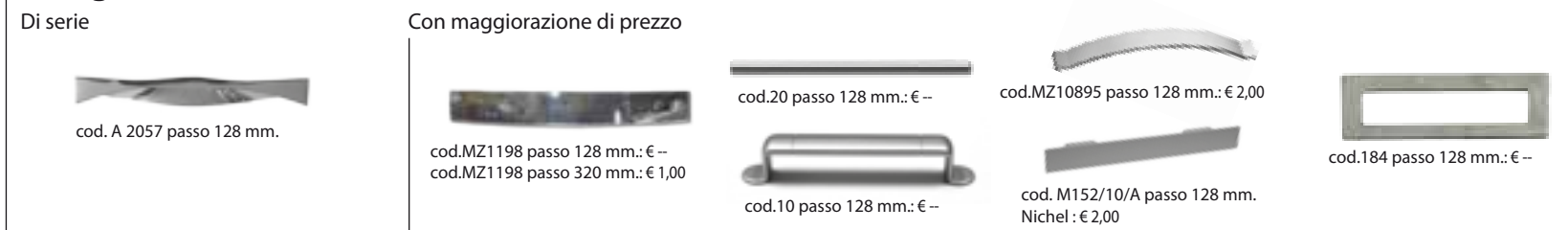



Colori Ante disponibili per mod. Sonia



acero



ciliegio



bianco

Colori Top spess. 4 cm.



travertino 1711 coral



marmo 3052 tf

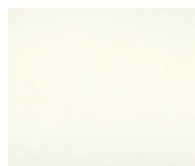

bianco 01 tf



noce scuro a 24



pietra 70 lqz



ciliegio 1971 tf



smart white 01



wraky 6056



rosa niagara

Maniglie

Di serie



cod.20 passo 128 mm.

Con maggiorazione di prezzo



cod.MZ1198 passo 128 mm.: € --
cod.MZ1198 passo 320 mm.: € 5,00



cod. A 2057 passo 128 mm.: € 3,00



cod.10 passo 128 mm.: € --



cod.MZ10895 passo 128 mm.: € 5,00



cod. M152/10/A passo 128 mm.
Nichel: € 7,00



cod.184 passo 128 mm.: € --



Colori Ante disponibili per mod. Luna



Colori Top spess. 4 cm.

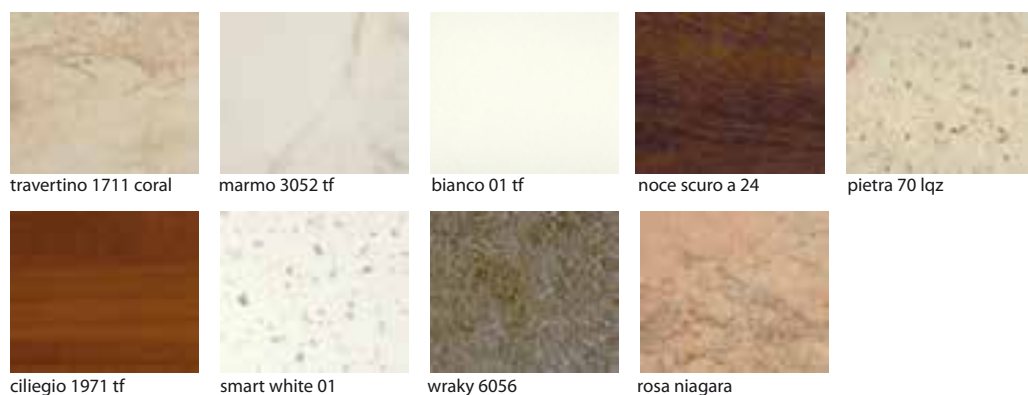

Maniglie



N.B.: Colore Sand e Bianco lucido K-74 disponibile in magazzino, tutti gli altri colori consegna in 30 gg.



Colori Ante disponibili per mod. Giada



Ciliegio

Colori Top spess. 4 cm.



travertino 1711 coral



marmo 3052 tf

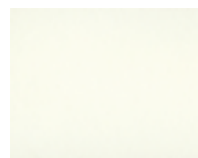

bianco 01 tf



noce scuro a 24



pietra 70 lqz



ciliegio 1971 tf



smart white 01



wraky 6056



rosa niagara

Maniglie

Di serie



cod.MZ10895 passo 128 mm.

Con maggiorazione di prezzo



cod.MZ1198 passo 128 mm.: € --
cod.MZ1198 passo 320 mm.: € --



cod.10 passo 128 mm.: € --



cod. M152/10/A passo 128 mm.
Nichel : € --

cod.20 passo 128 mm.: € --



cod. A 2057 passo 128 mm.: € --



cod.184 passo 128 mm.: € --



Colori Ante disponibili per mod. Sonia



acero



ciliegio



bianco

Colori Top spess. 4 cm.



travertino 1711 coral



marmo 3052 tf

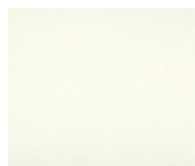

bianco 01 tf



noce scuro a 24



pietra 70 lqz



ciliegio 1971 tf



smart white 01



wraky 6056



rosa niagara

Maniglie

Di serie



cod.20 passo 128 mm.

Con maggiorazione di prezzo



cod.MZ1198 passo 128 mm.: € --
cod.MZ1198 passo 320 mm.: € 5,00



cod. A 2057 passo 128 mm.: € 3,00



cod.10 passo 128 mm.: € --



cod.MZ10895 passo 128 mm.: € 5,00



cod. M152/10/A passo 128 mm.
Nichel: € 7,00



cod.184 passo 128 mm.: € --



Colori Ante disponibili per mod. Romina

bianco lucido K-74	bordeaux lucido K-137	avorio lucido K-121	nero lucido k-140	cappuccino lucido K-138	beige lucido IHC-65	melanzana lucido K-144	rosso ferrari lucido R-153	ibisco lucido
rovere naturale I-78	rovere wengè I-103	rovere grigio R-195	rovere naturale R-145	melinga portuna R-160	rovere scuro R-146	arancio opaco A-100	noce tiepolo R-159	noce chiaro H-133
sand	oak melinga drak R-161	oak melinga white R-162	rustic	bianco opaco setato R-141	frassinato bianco A-31	moka naturale RIF 32	tranche A183	bianco opaco A-32

Colori Top spess. 4 cm.

travertino 1711 coral	marmo 3052 tf	bianco 01 tf	noce scuro a 24	pietra 70 lqz
ciliegio 1971 tf	smart white 01	wraky 6056	rosa niagara	

Maniglie

Di serie	Con maggiorazione di prezzo			
cod.MZ1198 passo 128 mm. cod.MZ1198 passo 320 mm.	cod. M152/10/A passo 128 mm. Nichel : € 1,00	cod.10 passo 128 mm.: € --	cod. A 2057 passo 128 mm.: € --	cod.MZ10895 passo 128 mm.: € 1,00
			cod.20 passo 128 mm.: € --	cod.184 passo 128 mm.: € 5,00



Colori Ante disponibili per mod. Luna



Colori Top spess. 4 cm.



Maniglie



N.B.: Colore Sand e Bianco lucido K-74 disponibile in magazzino, tutti gli altri colori consegna in 30 gg.



Colori Ante disponibili per mod. Erika



Colori Top spess. 4 cm.



Maniglie

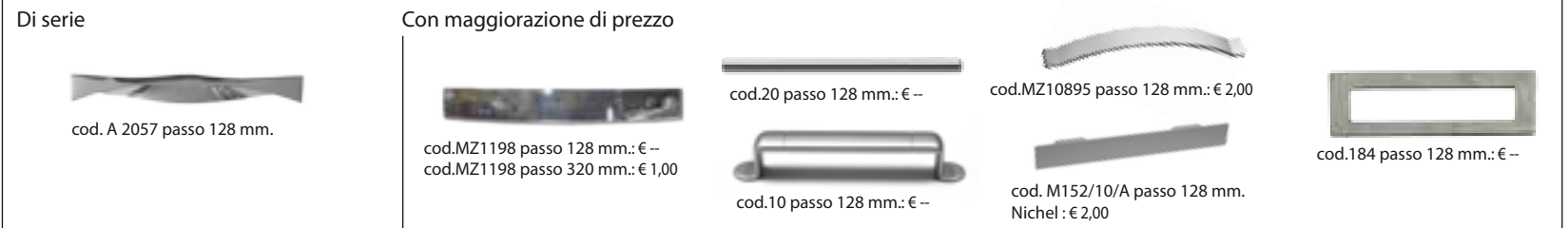



Colori Ante disponibili per mod. Sonia



acero



ciliegio



bianco

Colori Top spess. 4 cm.



travertino 1711 coral



marmo 3052 tf

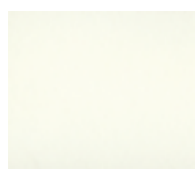

bianco 01 tf



noce scuro a 24



pietra 70 lqz



ciliegio 1971 tf



smart white 01



wraky 6056



rosa niagara

Maniglie

Di serie



cod.20 passo 128 mm.

Con maggiorazione di prezzo



cod.MZ1198 passo 128 mm.: € --
cod.MZ1198 passo 320 mm.: € 5,00



cod. A 2057 passo 128 mm.: € 3,00



cod.10 passo 128 mm.: € --



cod.MZ10895 passo 128 mm.: € 5,00



cod. M152/10/A passo 128 mm.
Nichel: € 7,00



cod.184 passo 128 mm.: € --



Colori Ante disponibili per mod. Luna

bianco lucido K-74	bordeaux lucido K-137	avorio lucido K-121	nero lucido k-140	cappuccino lucido K-138	beige lucido IHC-65	melanzana lucido K-144	rosso ferrari lucido R-153	ibisco lucido
rovere naturale I-78	rovere wengè I-103	rovere grigio R-195	rovere naturale R-145	melinga portuna R-160	rovere scuro R-146	arancio opaco A-100	noce tiepolo R-159	noce chiaro H-133
sand	oak melinga drak R-161	oak melinga white R-162	rustic	bianco opaco setato R-141	frassinato bianco A-31	moka naturale RIF 32	tranche A183	bianco opaco A-32

Colori Top spess. 4 cm.

travertino 1711 coral	marmo 3052 tf	bianco 01 tf	noce scuro a 24	pietra 70 lqz
ciliegio 1971 tf	smart white 01	wraky 6056	rosa niagara	

Maniglie

Di serie	Con maggiorazione di prezzo			
cod. M152/10/A passo 128 mm. Nichel	cod.MZ1198 passo 128 mm.: € -- cod.MZ1198 passo 320 mm.: € --	cod.184 passo 128 mm.: € --	cod.10 passo 128 mm.: € --	cod.MZ10895 passo 128 mm.: € --

N.B.: Colore Sand e Bianco lucido K-74 disponibile in magazzino, tutti gli altri colori consegna in 30 gg.



Colori Ante disponibili per mod. Sonia

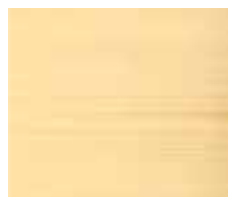

acero



ciliegio



bianco

Colori Top spess. 4 cm.



travertino 1711 coral



marmo 3052 tf



bianco 01 tf



noce scuro a 24



pietra 70 lqz



ciliegio 1971 tf



smart white 01



wraky 6056



rosa niagara

Maniglie

Di serie



cod.20 passo 128 mm.

Con maggiorazione di prezzo



cod.MZ1198 passo 128 mm.: € --
cod.MZ1198 passo 320 mm.: € 5,00



cod. A 2057 passo 128 mm.: € 3,00



cod.10 passo 128 mm.: € --



cod.MZ10895 passo 128 mm.: € 5,00



cod. M152/10/A passo 128 mm.
Nichel: € 7,00



cod.184 passo 128 mm.: € --



Colori Ante disponibili per mod. Erika



Colori Top spess. 4 cm.



Maniglie

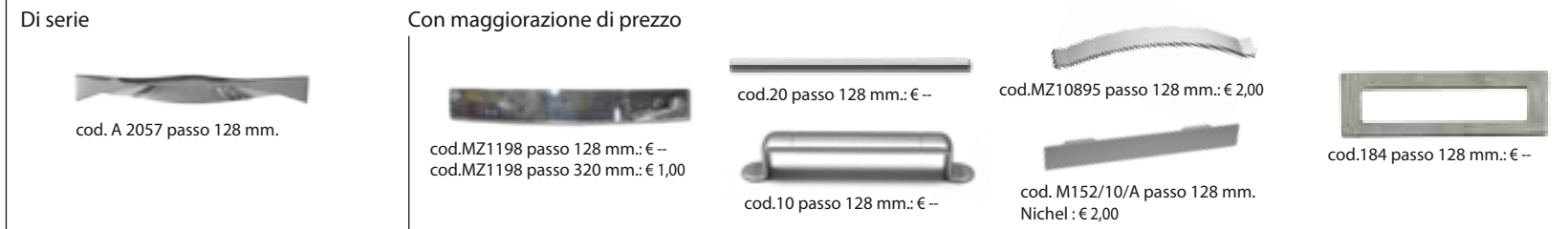



Colori Ante disponibili per mod. Romina

bianco lucido K-74	bordeaux lucido K-137	avorio lucido K-121	nero lucido k-140	cappuccino lucido K-138	beige lucido IHC-65	melanzana lucido K-144	rosso ferrari lucido R-153	ibisco lucido
rovere naturale I-78	rovere wengè I-103	rovere grigio R-195	rovere naturale R-145	melinga portuna R-160	rovere scuro R-146	arancio opaco A-100	noce tiepolo R-159	noce chiaro H-133
sand	oak melinga drak R-161	oak melinga white R-162	rustic	bianco opaco setato R-141	frassinato bianco A-31	moka naturale RIF 32	tranche A183	bianco opaco A-32

Colori Top spess. 4 cm.

travertino 1711 coral	marmo 3052 tf	bianco 01 tf	noce scuro a 24	pietra 70 lqz
ciliegio 1971 tf	smart white 01	wraky 6056	rosa niagara	

Maniglie

Di serie	Con maggiorazione di prezzo			
cod.MZ1198 passo 128 mm. cod.MZ1198 passo 320 mm.	cod. M152/10/A passo 128 mm. Nichel : € 1,00	cod.10 passo 128 mm.: € --	cod. A 2057 passo 128 mm.: € --	cod.MZ10895 passo 128 mm.: € 1,00
			cod.20 passo 128 mm.: € --	cod.184 passo 128 mm.: € 5,00

N.B.: Colore Bianco lucido K74 e Rovere naturale 145 disponibile in magazzino, tutti gli altri colori consegna in 30 gg.



Colori Ante disponibili per mod. Manila



Sabbia



Bianco

Colori Top spess. 4 cm.



travertino 1711 coral



marmo 3052 tf

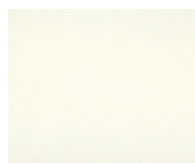

bianco 01 tf



noce scuro a 24



pietra 70 lqz



ciliegio 1971 tf



smart white 01



wraky 6056



rosa niagara

Maniglie

Di serie



cod. H 126/1 passo 128 mm.
Cromato lucido

Con maggiorazione di prezzo



cod.MZ1198 passo 128 mm.: € --
cod.MZ1198 passo 320 mm.: € --



cod.10 passo 128 mm.: € --



cod. A 2057 passo 128 mm.: € --



cod.20 passo 128 mm.: € --



cod.MZ10895 passo 128 mm.: € --



cod.184 passo 128 mm.: € --



Colori Ante disponibili per mod. Erika

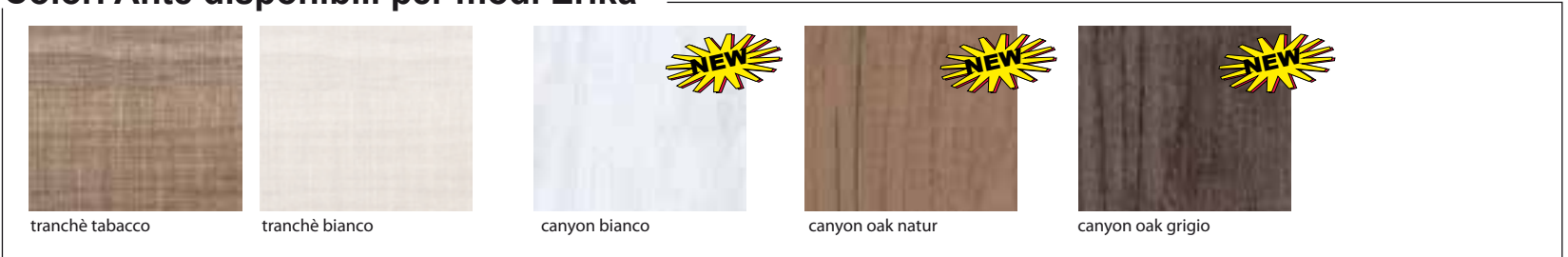

Colori Top spess. 4 cm.



Maniglie

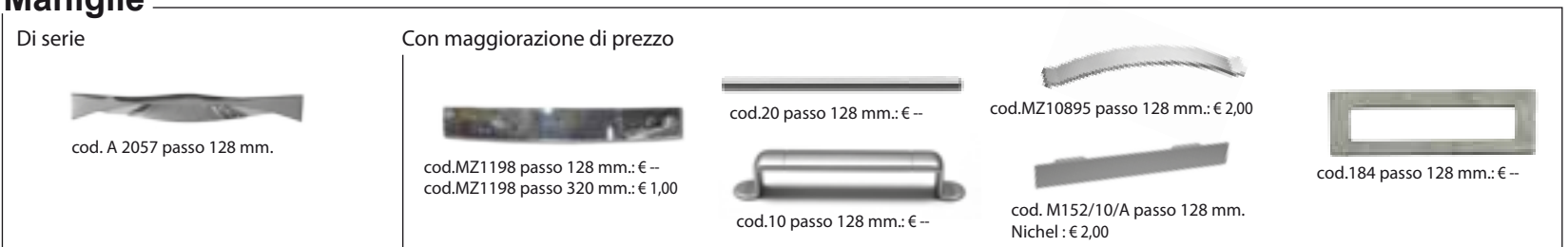



Colori Ante disponibili per mod. Romina

bianco lucido K-74	bordeaux lucido K-137	avorio lucido K-121	nero lucido k-140	cappuccino lucido K-138	beige lucido IHC-65	melanzana lucido K-144	rosso ferrari lucido R-153	ibisco lucido
rovere naturale I-78	rovere wengè I-103	rovere grigio R-195	rovere naturale R-145	melinga portuna R-160	rovere scuro R-146	arancio opaco A-100	noce tiepolo R-159	noce chiaro H-133
sand	oak melinga drak R-161	oak melinga white R-162	rustic	bianco opaco setato R-141	frassinato bianco A-31	moka naturale RIF 32	tranche A183	bianco opaco A-32

Colori Top spess. 4 cm.

travertino 1711 coral	marmo 3052 tf	bianco 01 tf	noce scuro a 24	pietra 70 lqz
ciliegio 1971 tf	smart white 01	wraky 6056	rosa niagara	

Maniglie

Di serie	Con maggiorazione di prezzo			
cod.MZ1198 passo 128 mm. cod.MZ1198 passo 320 mm.	cod. M152/10/A passo 128 mm. Nichel : € 1,00	cod.10 passo 128 mm.: € --	cod. A 2057 passo 128 mm.: € --	cod.MZ10895 passo 128 mm.: € 1,00
			cod.20 passo 128 mm.: € --	cod.184 passo 128 mm.: € 5,00



Colori Ante disponibili per mod. Luna



Colori Top spess. 4 cm.

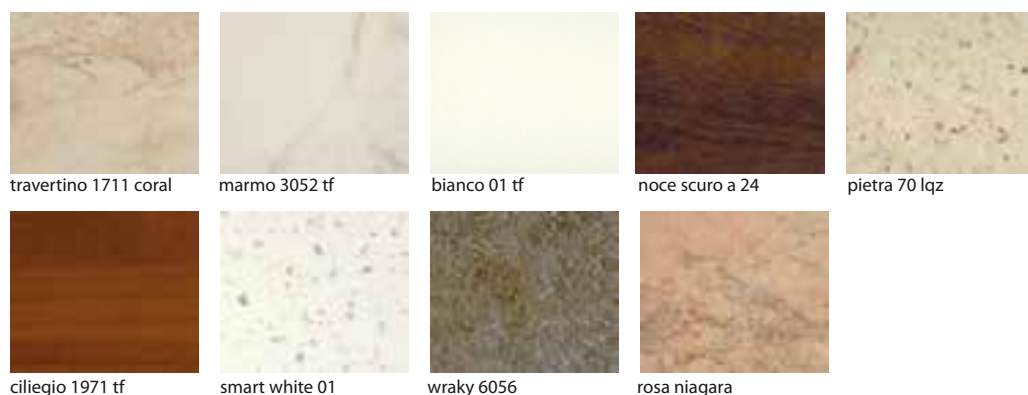

Maniglie



N.B.: Colore Sand e Bianco lucido K-74 disponibile in magazzino, tutti gli altri colori consegna in 30 gg.



Colori Ante disponibili per mod. Erika



Colori Top spess. 4 cm.



Maniglie

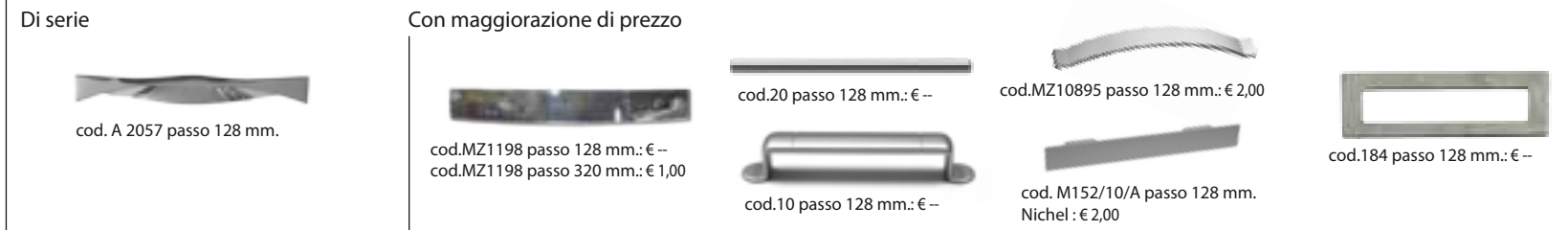



Colori Ante disponibili per mod. Manila



Sabbia



Bianco

Colori Top spess. 4 cm.



travertino 1711 coral



marmo 3052 tf

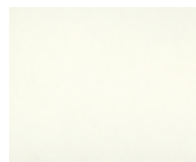

bianco 01 tf



noce scuro a 24



pietra 70 lqz



ciliegio 1971 tf



smart white 01



wraky 6056



rosa niagara

Maniglie

Di serie



cod. H 126/1 passo 128 mm.
Cromato lucido

Con maggiorazione di prezzo



cod.MZ1198 passo 128 mm.: € --
cod.MZ1198 passo 320 mm.: € --



cod.10 passo 128 mm.: € --



cod. A 2057 passo 128 mm.: € --



cod.20 passo 128 mm.: € --



cod.MZ10895 passo 128 mm.: € --



cod.184 passo 128 mm.: € --



Colori Ante disponibili per mod. Gaia

Giallo acido opaco ICA 131	Rosso corallo opaco R3001	Bordeaux opaco R3003	Alluminio opaco	Senape opaco	Blu notte opaco	Moka opaco R8017	Bianco opaco	Tortora scuro opaco ICA 177
Panna opaco	Giallo acido ICA 131	Rosso corallo R3001	Bordeaux R3003	Alluminio	Senape	Blu notte	Moka R8017	Bianco
Arancione vivace R2004	Prugna R4007	Porpora vivace R4006	Grigio canna fucile R7015	Grigio chiaro R7047	Tortora scuro ICA 177	Tortora chiaro ICA 119	Cipria N190	

Colori Top spess. 4 cm.

travertino 1711 coral	marmo 3052 tf	bianco 01 tf	noce scuro a 24	pietra 70 lqz
ciliegio 1971 tf	smart white 01	wraky 6056	rosa niagara	

N.B.: La Gaia (cucina laccata) consegna in 30 gg.



Colori Ante disponibili per mod. Erika



Colori Top spess. 4 cm.



Maniglie

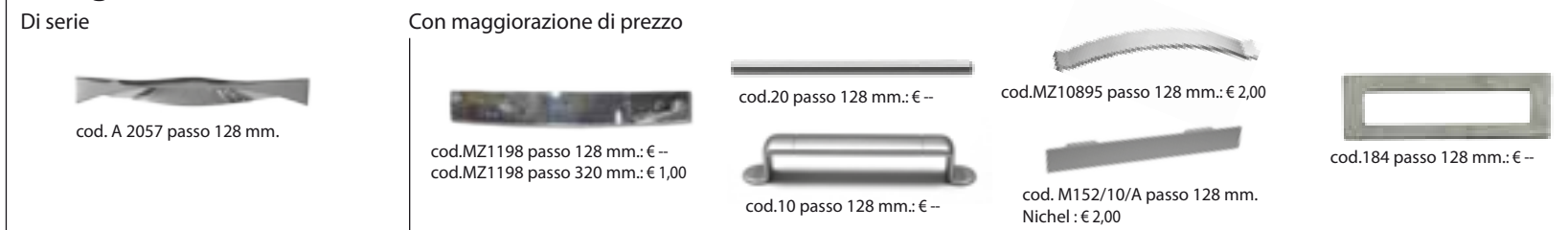



Colori Ante disponibili per mod. Luna



Colori Top spess. 4 cm.



Maniglie





Colori Ante disponibili per mod. Giulia (con profilo verde)



Anta corda



Anta vetro

Colori Top spess. 4 cm.



travertino 1711 coral



marmo 3052 tf

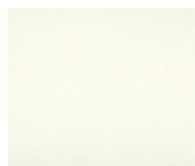

bianco 01 tf



noce scuro a 24



pietra 70 lqz



ciliegio 1971 tf



smart white 01



wraky 6056



rosa niagara

Maniglie

Di serie



cod. MZC 36/96
cod. MZC 36/128

Con maggiorazione di prezzo



cod.MZ10981 passo 128 mm.: € --



cod.MZ10922 passo 128 mm.: € --



Colori Ante disponibili per mod. Milady



Ciliegio



Anta vetro

Colori Top spess. 4 cm.



travertino 1711 coral



marmo 3052 tf

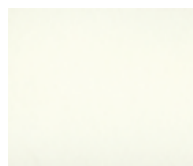

bianco 01 tf



noce scuro a 24



pietra 70 lqz



ciliegio 1971 tf



smart white 01



wraky 6056



rosa niagara

Maniglie

Di serie



cod.MZ10981 passo 128 mm.

Con maggiorazione di prezzo



cod. MZC 36/96: € 2,00
cod. MZC 36/128: € 2,00



cod.MZ10922 passo 128 mm.: € 1,00



Colori Ante disponibili per mod. Francesca



Ciliegio



Anta vetro

Colori Top spess. 4 cm.



travertino 1711 coral



marmo 3052 tf

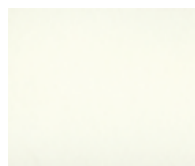

bianco 01 tf



noce scuro a 24



pietra 70 lqz



ciliegio 1971 tf



smart white 01



wraky 6056



rosa niagara

Maniglie

Di serie



cod.MZ10922 passo 128 mm.

Con maggiorazione di prezzo



cod. MZC 36/96 : € 1,00
cod. MZC 36/128 : € 1,00



cod.MZ10981 passo 128 mm. : € --



Colori Ante disponibili per mod. Milady



Ciliegio



Anta vetro

Colori Top spess. 4 cm.



travertino 1711 coral



marmo 3052 tf

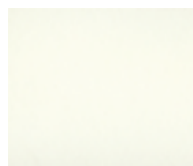

bianco 01 tf



noce scuro a 24



pietra 70 lqz



ciliegio 1971 tf



smart white 01



wraky 6056



rosa niagara

Maniglie

Di serie



cod.MZ10981 passo 128 mm.

Con maggiorazione di prezzo



cod. MZC 36/96: € 2,00
cod. MZC 36/128: € 2,00



cod.MZ10922 passo 128 mm.: € 1,00



Colori Ante disponibili per mod. Francesca



Ciliegio



Anta vetro

Colori Top spess. 4 cm.



travertino 1711 coral



marmo 3052 tf

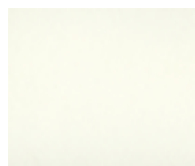

bianco 01 tf



noce scuro a 24



pietra 70 lqz



ciliegio 1971 tf



smart white 01



wraky 6056



rosa niagara

Maniglie

Di serie



cod.MZ10922 passo 128 mm.

Con maggiorazione di prezzo



cod. MZC 36/96 : € 1,00
cod. MZC 36/128 : € 1,00



cod.MZ10981 passo 128 mm. : € --



Colori Ante disponibili per mod. Francesca



Ciliegio



Anta vetro

Colori Top spess. 4 cm.



travertino 1711 coral



marmo 3052 tf

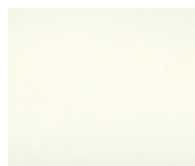

bianco 01 tf



noce scuro a 24



pietra 70 lqz



ciliegio 1971 tf



smart white 01



wraky 6056



rosa niagara

Maniglie

Di serie



cod.MZ10922 passo 128 mm.

Con maggiorazione di prezzo



cod. MZC 36/96 : € 1,00
cod. MZC 36/128 : € 1,00



cod.MZ10981 passo 128 mm. : € --



Colori Ante disponibili per mod. Giulia (con profilo verde)



Anta corda



Anta vetro

Colori Top spess. 4 cm.



travertino 1711 coral



marmo 3052 tf

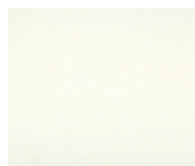

bianco 01 tf



noce scuro a 24



pietra 70 lqz



ciliegio 1971 tf



smart white 01



wraky 6056



rosa niagara

Maniglie

Di serie



cod. MZC 36/96
cod. MZC 36/128

Con maggiorazione di prezzo



cod.MZ10981 passo 128 mm.: € --



cod.MZ10922 passo 128 mm.: € --



Colori Ante disponibili per mod. Milady



Ciliegio



Anta vetro

Colori Top spess. 4 cm.



travertino 1711 coral



marmo 3052 tf

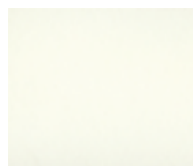

bianco 01 tf



noce scuro a 24



pietra 70 lqz



ciliegio 1971 tf



smart white 01



wraky 6056



rosa niagara

Maniglie

Di serie



cod.MZ10981 passo 128 mm.

Con maggiorazione di prezzo



cod. MZC 36/96: € 2,00
cod. MZC 36/128: € 2,00



cod.MZ10922 passo 128 mm.: € 1,00



Colori Ante disponibili per mod. Francesca



Ciliegio



Anta vetro

Colori Top spess. 4 cm.



travertino 1711 coral



marmo 3052 tf

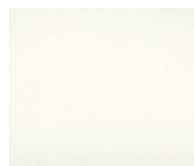

bianco 01 tf



noce scuro a 24



pietra 70 lqz



ciliegio 1971 tf



smart white 01



wraky 6056



rosa niagara

Maniglie

Di serie



cod.MZ10922 passo 128 mm.

Con maggiorazione di prezzo



cod. MZC 36/96 : € 1,00
cod. MZC 36/128 : € 1,00



cod.MZ10981 passo 128 mm. : € --



Colori Ante disponibili per mod. Milady



Ciliegio



Anta vetro

Colori Top spess. 4 cm.



travertino 1711 coral



marmo 3052 tf

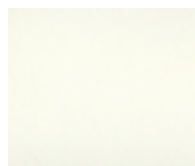

bianco 01 tf



noce scuro a 24



pietra 70 lqz



ciliegio 1971 tf



smart white 01



wraky 6056



rosa niagara

Maniglie

Di serie



cod.MZ10981 passo 128 mm.

Con maggiorazione di prezzo



cod. MZC 36/96: € 2,00
cod. MZC 36/128: € 2,00



cod.MZ10922 passo 128 mm.: € 1,00

Linea Chic

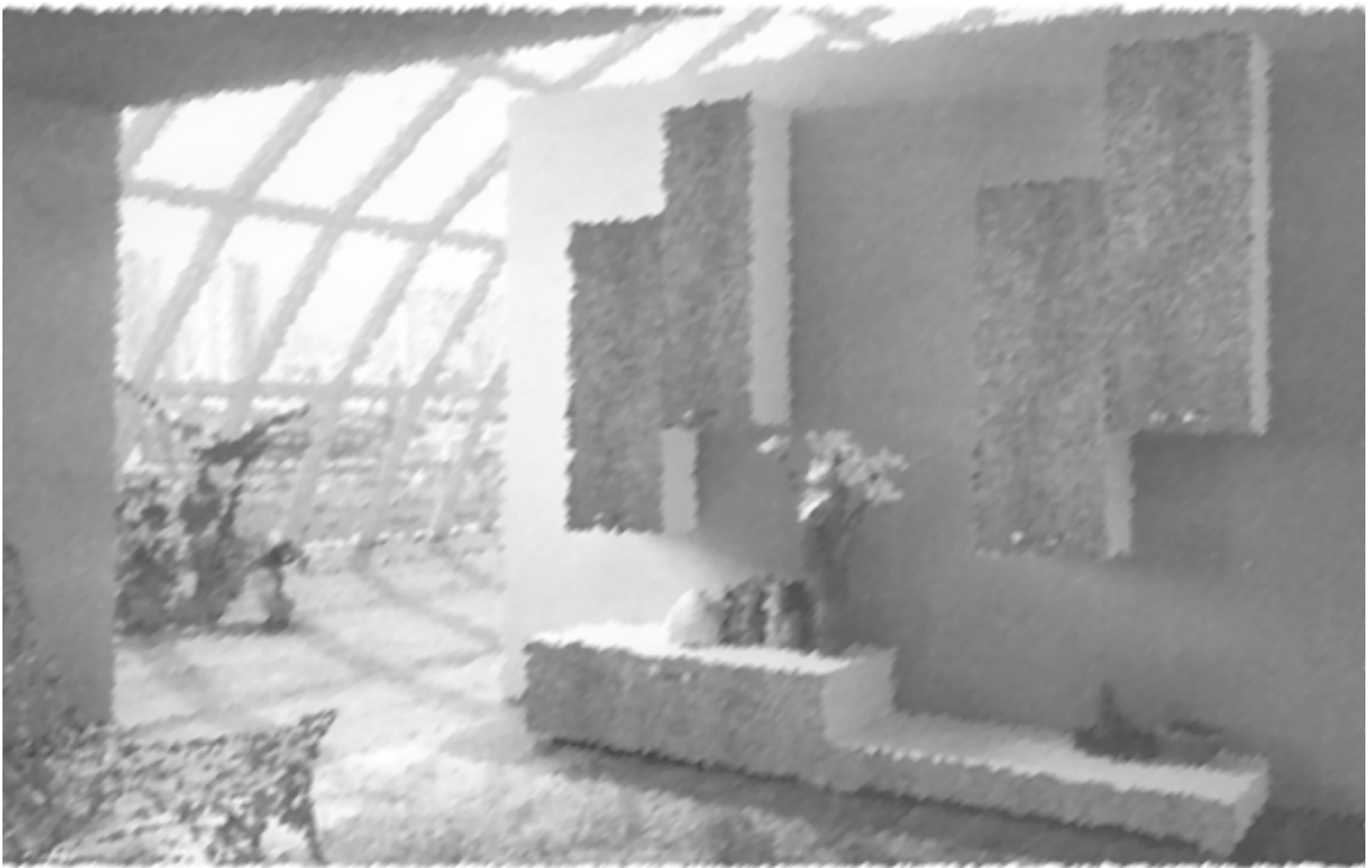

Living

Composizione 300 living (es.mod.Erika) non realizzabile con i modelli classici / Manila / Giada



Composizione 301 living (es.mod.Luna) non realizzabile con i modelli classici / Manila / Giada



Composizione 302 living (es.mod.Erika) realizzabile con tutti i modelli del catalogo



Composizione 303 living (es.mod.Luna) realizzabile con tutti i modelli del catalogo



Caratteristiche tecniche

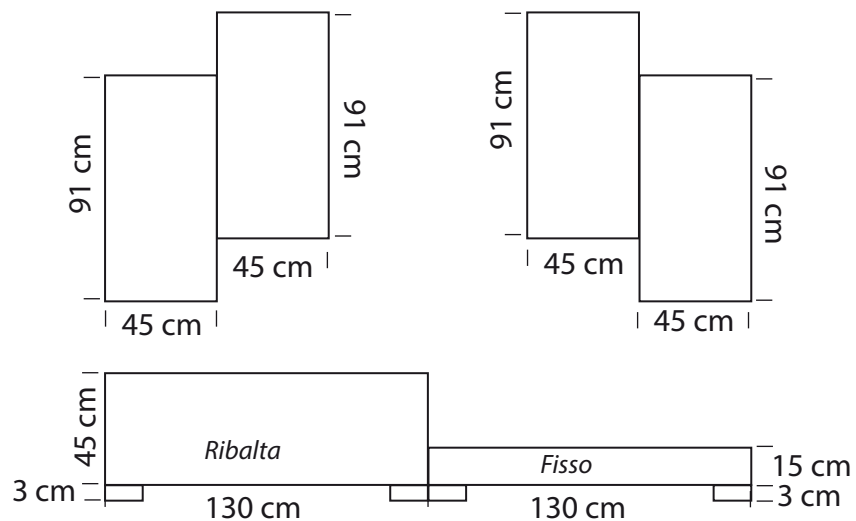

Composizione 300

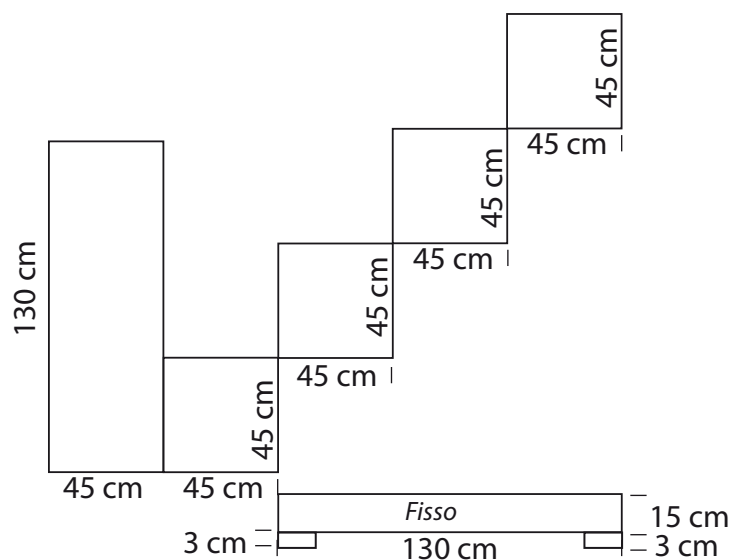

Composizione 301

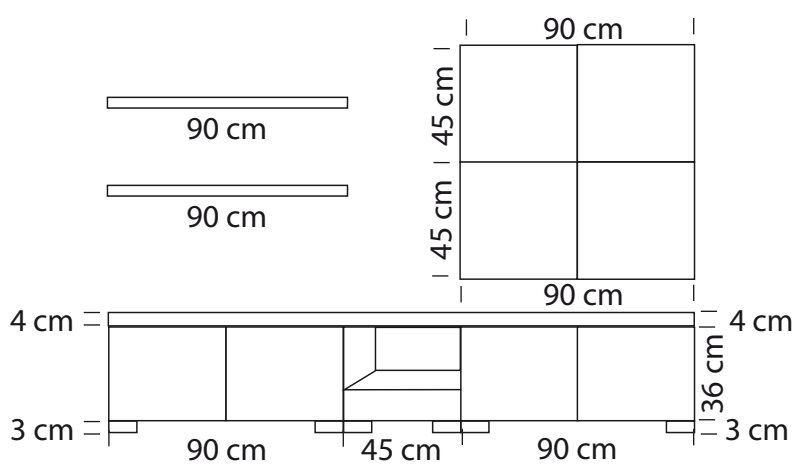

Composizione 302

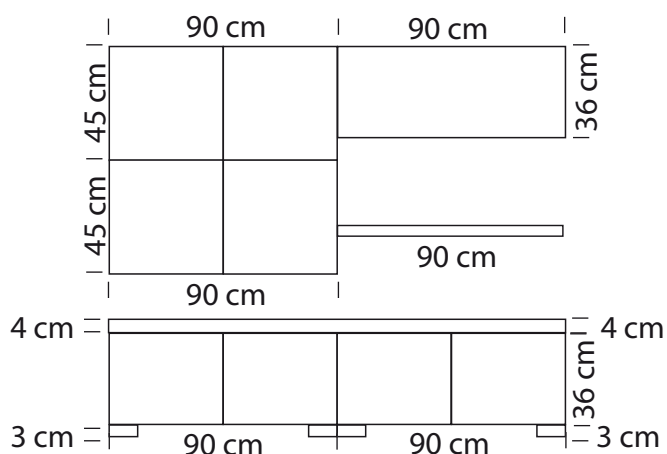

Composizione 303