

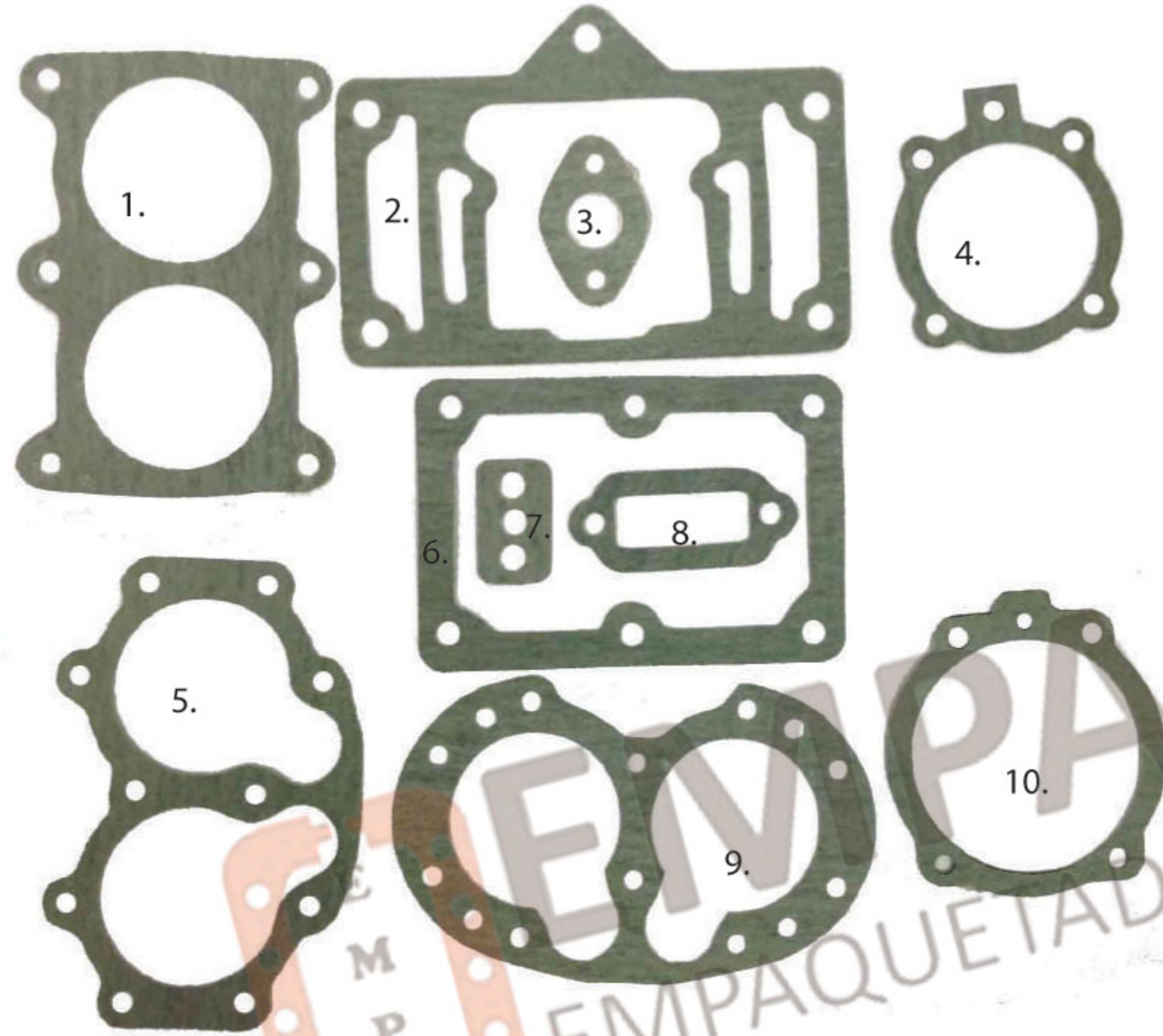

EMPACAR LTDA.

RETENEDORES Y EMPAQUETADURAS PARA AUTOMOTORES



- 1. CO - 20 - 00832 A - 01 - 40 - 02
- 2. CO - 20 - 00720 A - 01 - 40 - 02
- 3. CO - 20 - 00197 A - 01 - 40 - 02
- 4. CO - 20 - 00197 - 01 - 40 - 02
- 5. CO - 20 - 03076 - 01 - 40 - 02
- 6. CO - 20 - 03359 - 01 - 40 - 02
- 7. CO - 20 - 01611 A - 01 - 40 - 02
- 8. CO - 20 - 01611 B - 01 - 40 - 02
- 9. CO - 20 - 00832 B - 01 - 40 - 02
- 10. CO - 20 - 00072 - 01 - 40 - 02 / CANTIDAD (2)

JO - 20 - 00720



- 1. CO - 07 - 01792
- 2. CO - 07 - 02360
- 3. CO - 07 - 01790
- 4. CO - 07 - 02390
- 5. CO - 07 - 03459
- 6. CO - 07 - 01791
- 7. CO - 07 - 01456

JO - 07 - 02390



EMPACAR LTDA.

RETENEDORES Y EMPAQUETADURAS PARA AUTOMOTORES

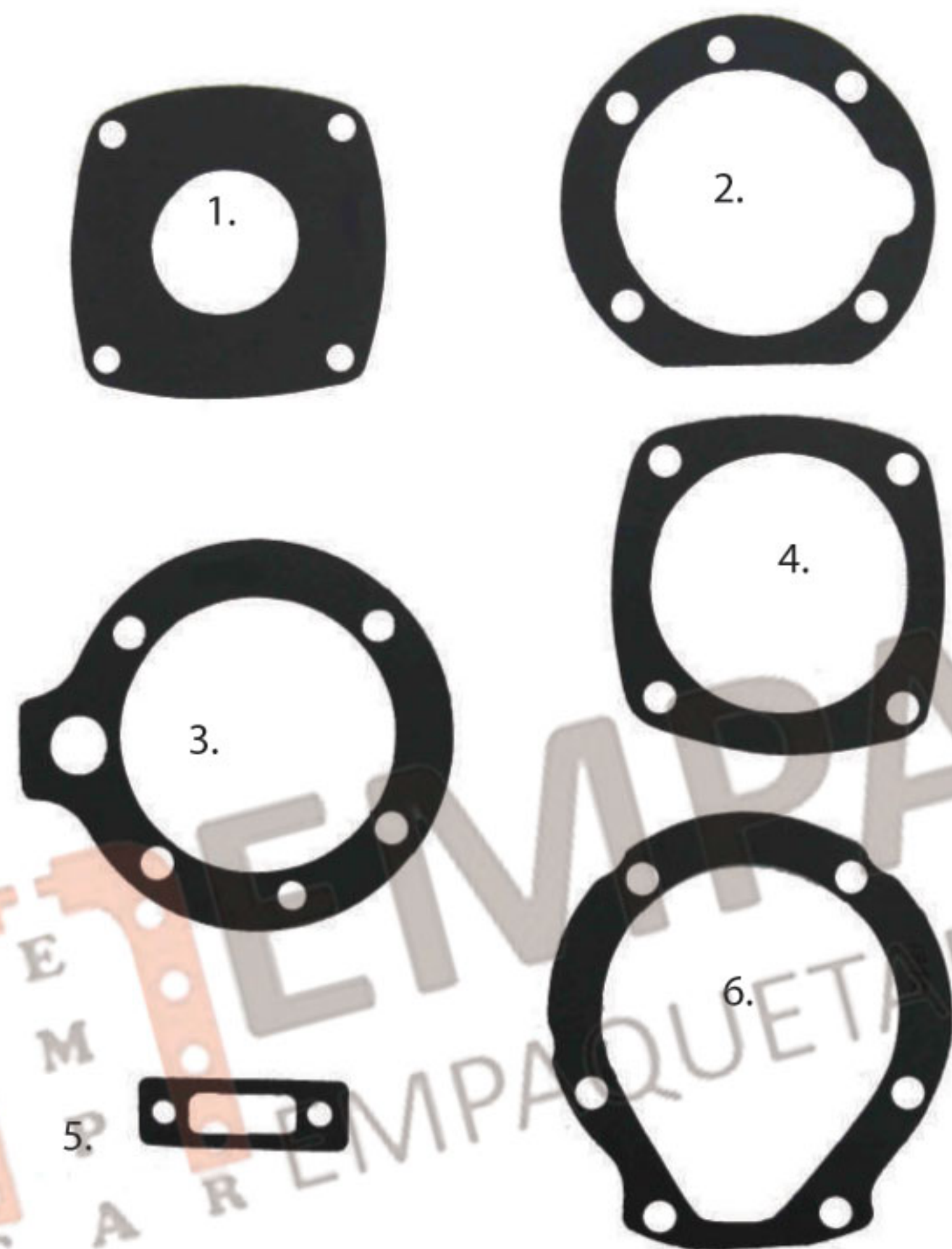

1. CO - 07 - 01456
2. CO - 07 - 01790
3. CO - 07 - 02177
4. CO - 07 - 01791
5. CO - 07 - 03459
6. CO - 07 - 01792

JO - 07 - 01790
CUMMINS NH - 350

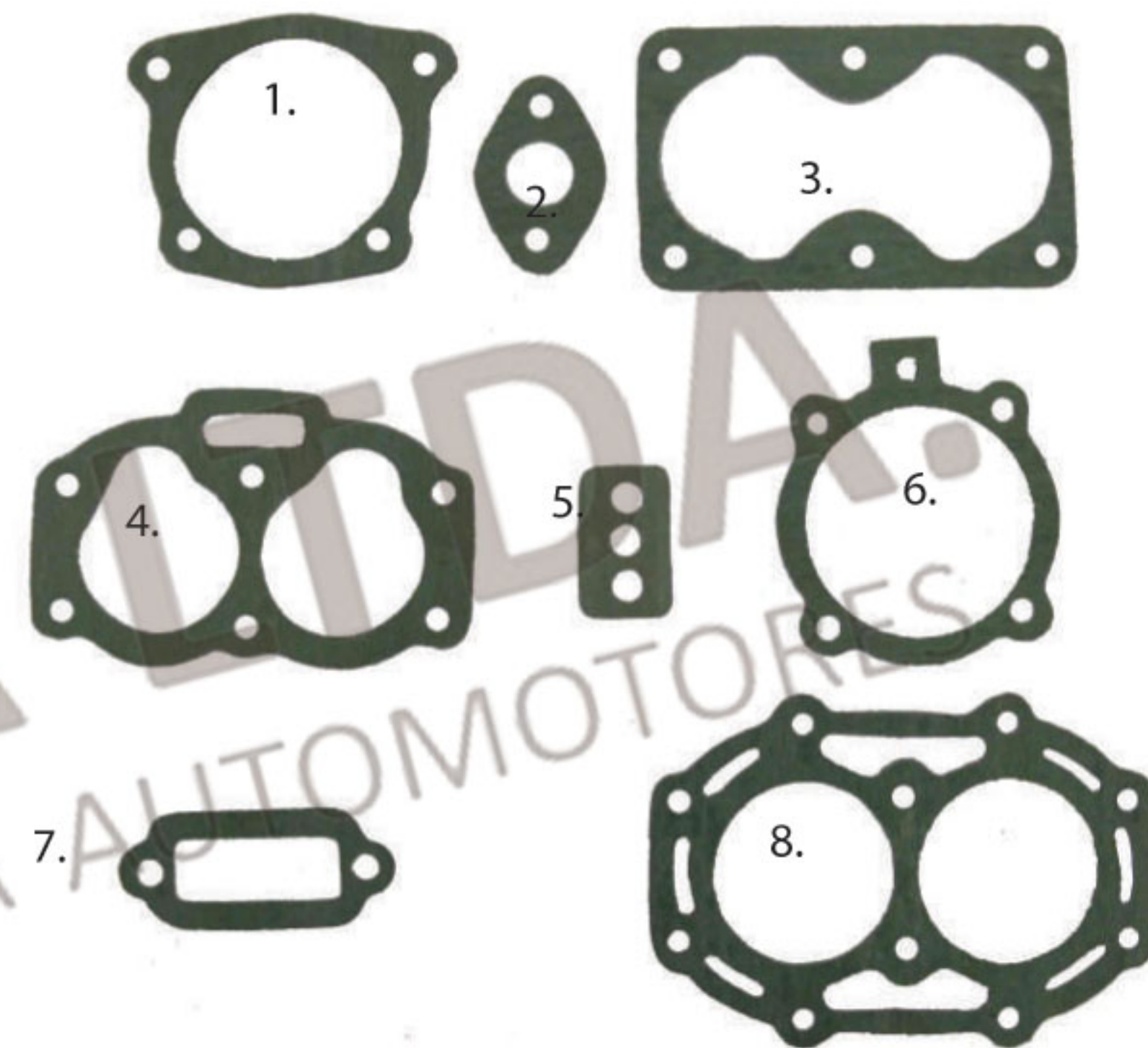

1. CO - 20 - 01438 / (CANTIDAD 2)
2. CO - 20 - 00197 A
3. CO - 20 - 01437
4. CO - 20 - 01439
5. CO - 20 - 01611 A
6. CO - 20 - 00197
7. CO - 20 - 06111 B
8. CO - 20 - 00795

JO - 20 - 01437
MIDLAN 7 PIES



EMPACAR LTDA.

RETENEDORES Y EMPAQUETADURAS PARA AUTOMOTORES

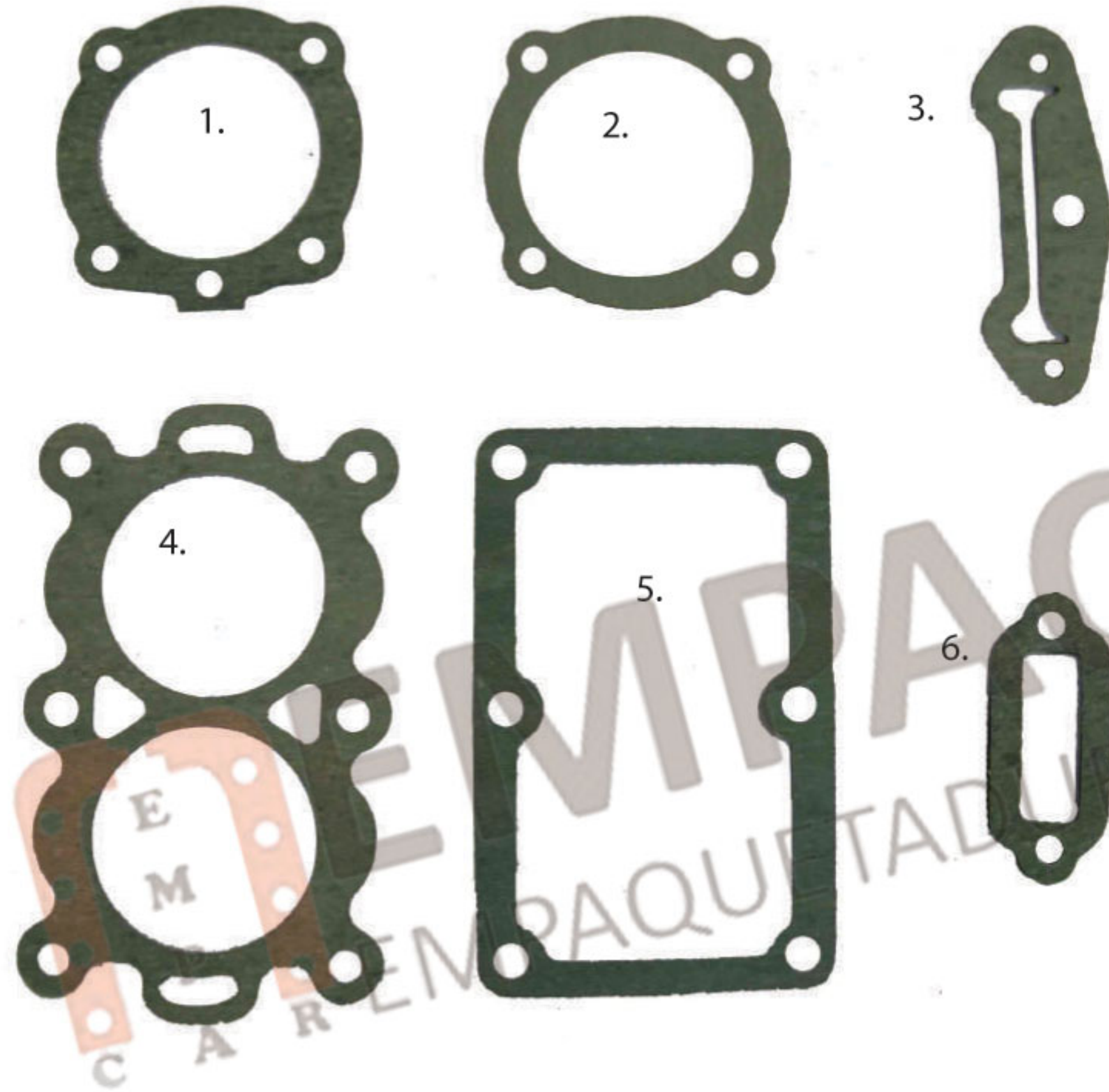

- 1. CO - 20 - 02229 B
- 2. CO - 20 - 02229 A
- 3. CO - 20 - 02510 / (CANTIDAD 2)
- 4. CO - 20 - 02230
- 5. CO - 20 - 02228
- 6. CO - 20 - 01611 B / (CANTIDAD 2)

JO - 20 - 02228
MIDLAN 13 PIES

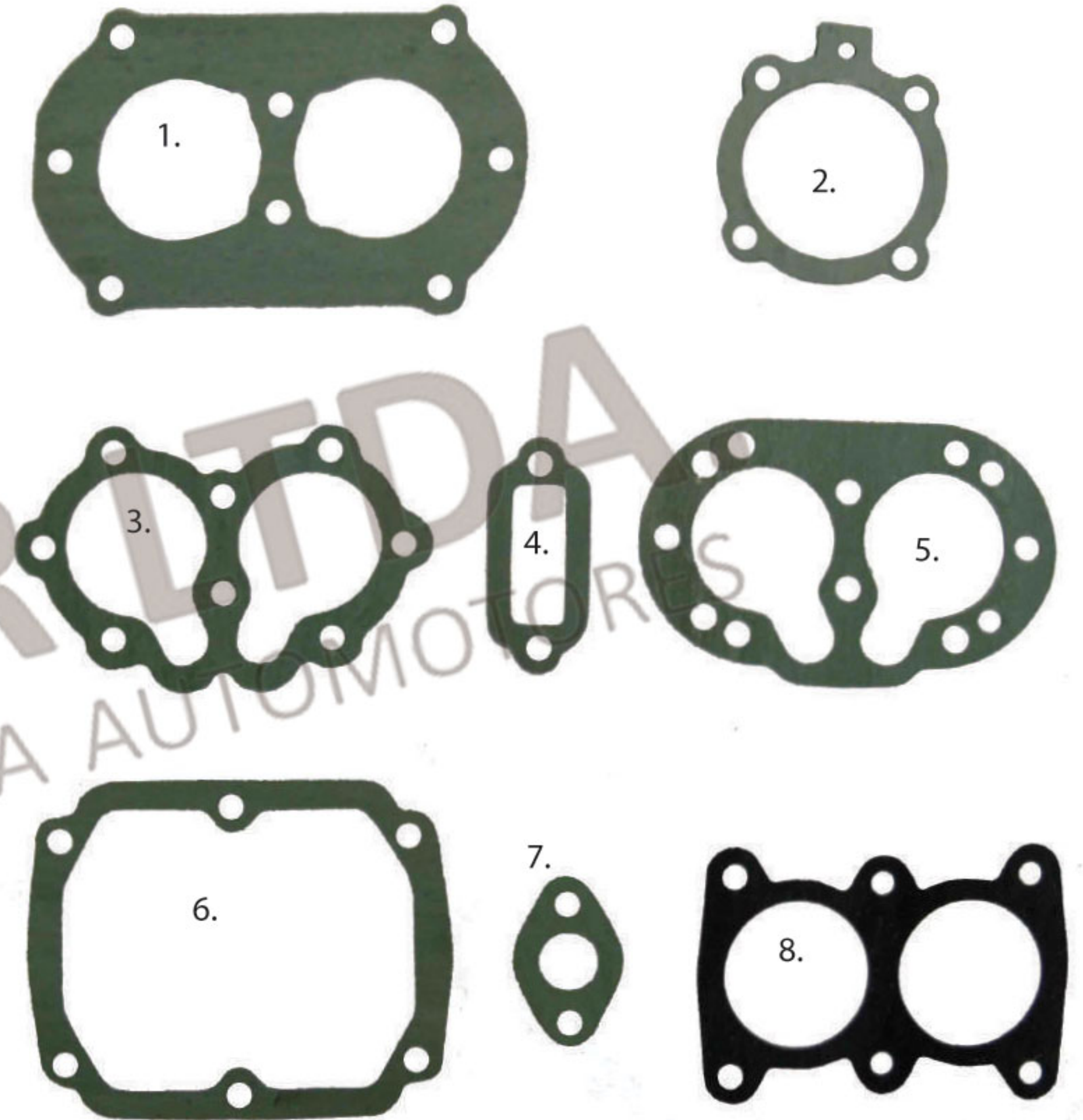

- 1. CO - 20 - 00720 B
- 2. CO - 20 - 00197 / (CANTIDAD 2)
- 3. CO - 20 - 00457
- 4. CO - 20 - 01611 B
- 5. CO - 20 - 00212
- 6. CO - 20 - 00092
- 7. CO - 20 - 0197 A
- 8. CO - 20 - 00198

JO - 20 - 00212
TUFLO 400



EMPACAR LTDA.

RETENEDORES Y EMPAQUETADURAS PARA AUTOMOTORES

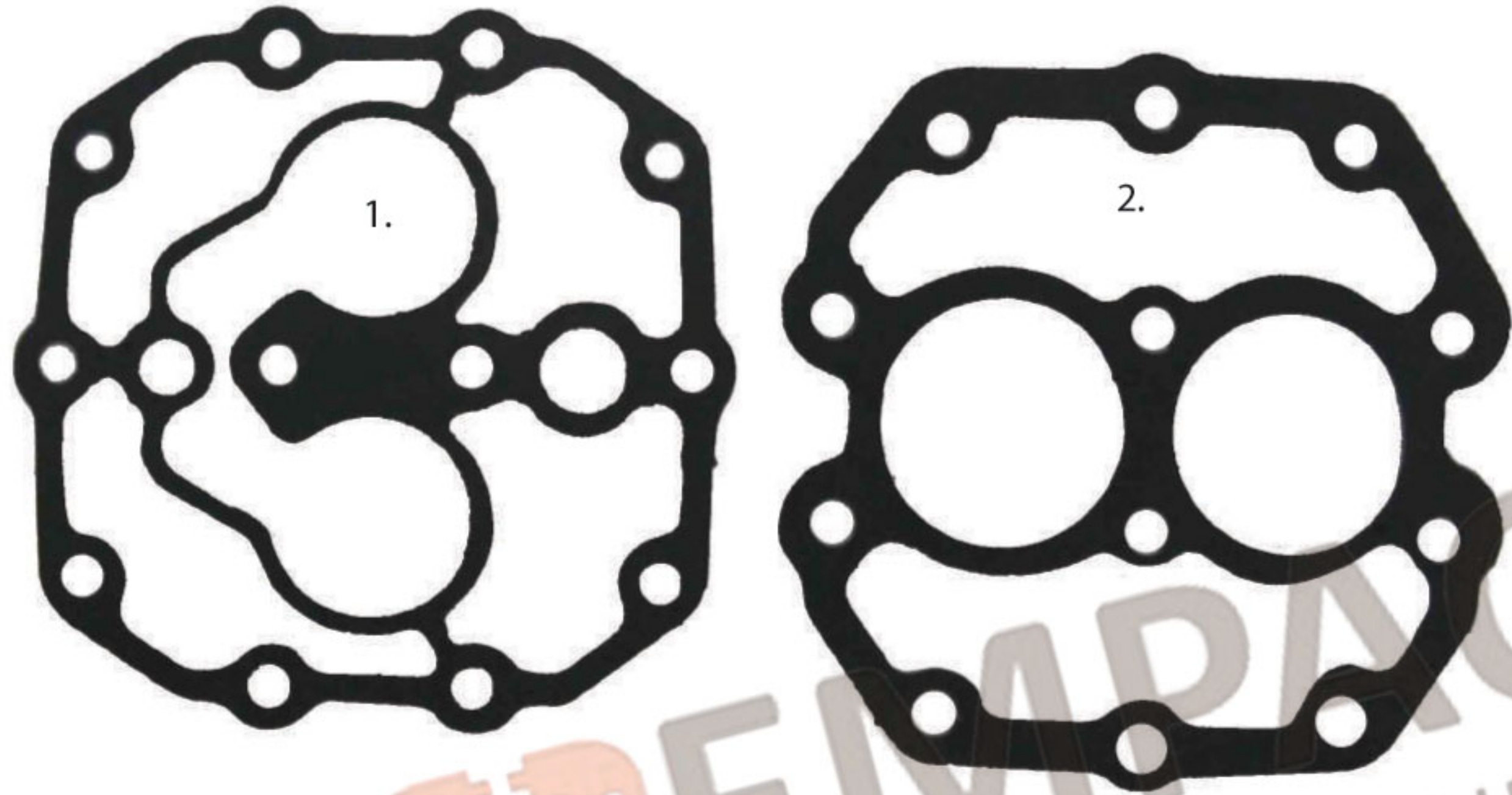

- 1. T - 3005
- 2. T - 3004

JO - 20 - 03004
FORD CABEZOTE YORQUE

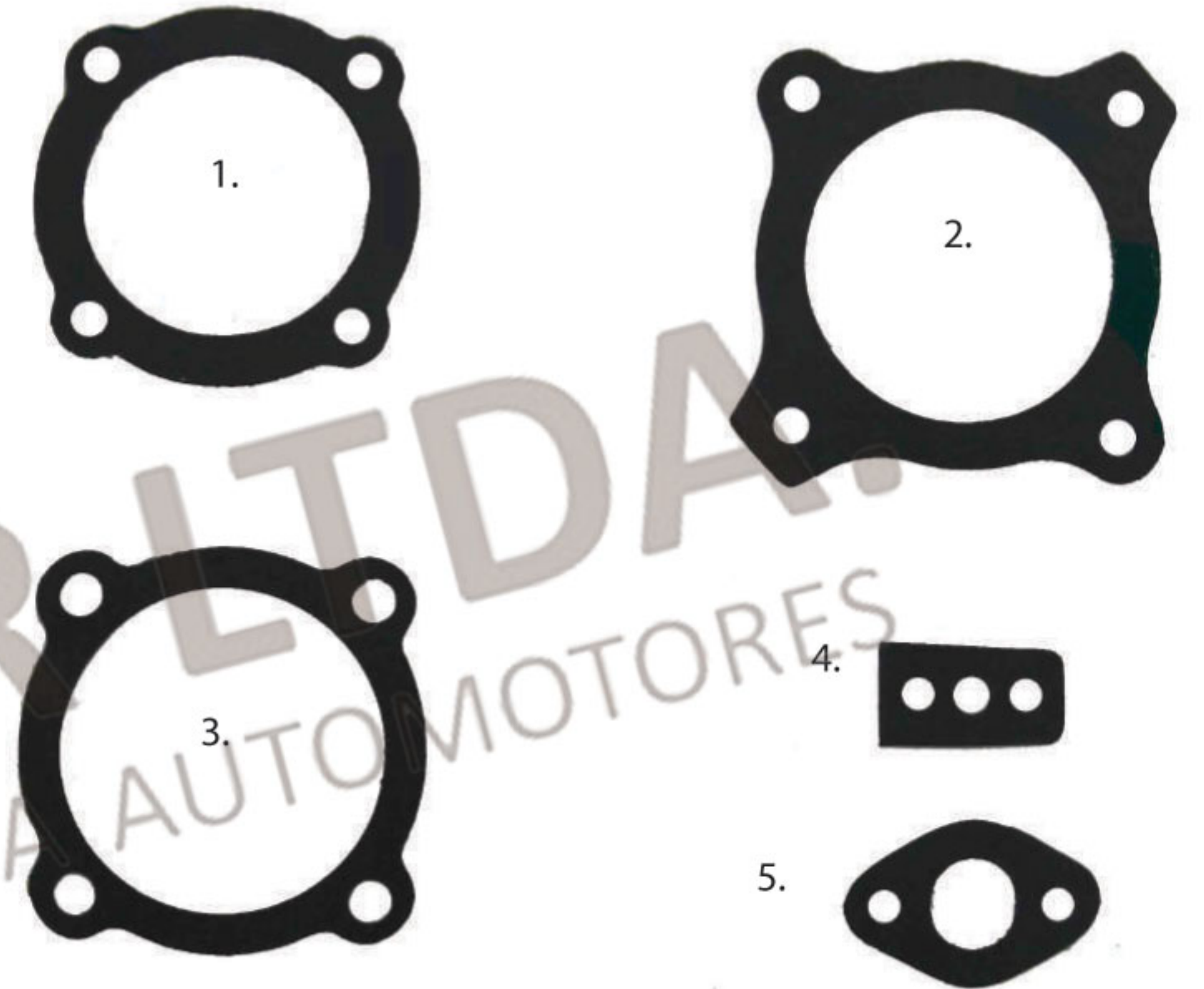

- 1. CO - 20 - 02229 A / (CANTIDAD 2)
- 2. CO - 20 - 03475
- 3. CO - 20 - 03474
- 4. T - 3433
- 5. CO - 20 - 00197 A

JO - 20 - 03433
FORD - MAZDA - CHEVROLET
- DODGE



EMPACAR LTDA.

RETENEDORES Y EMPAQUETADURAS PARA AUTOMOTORES

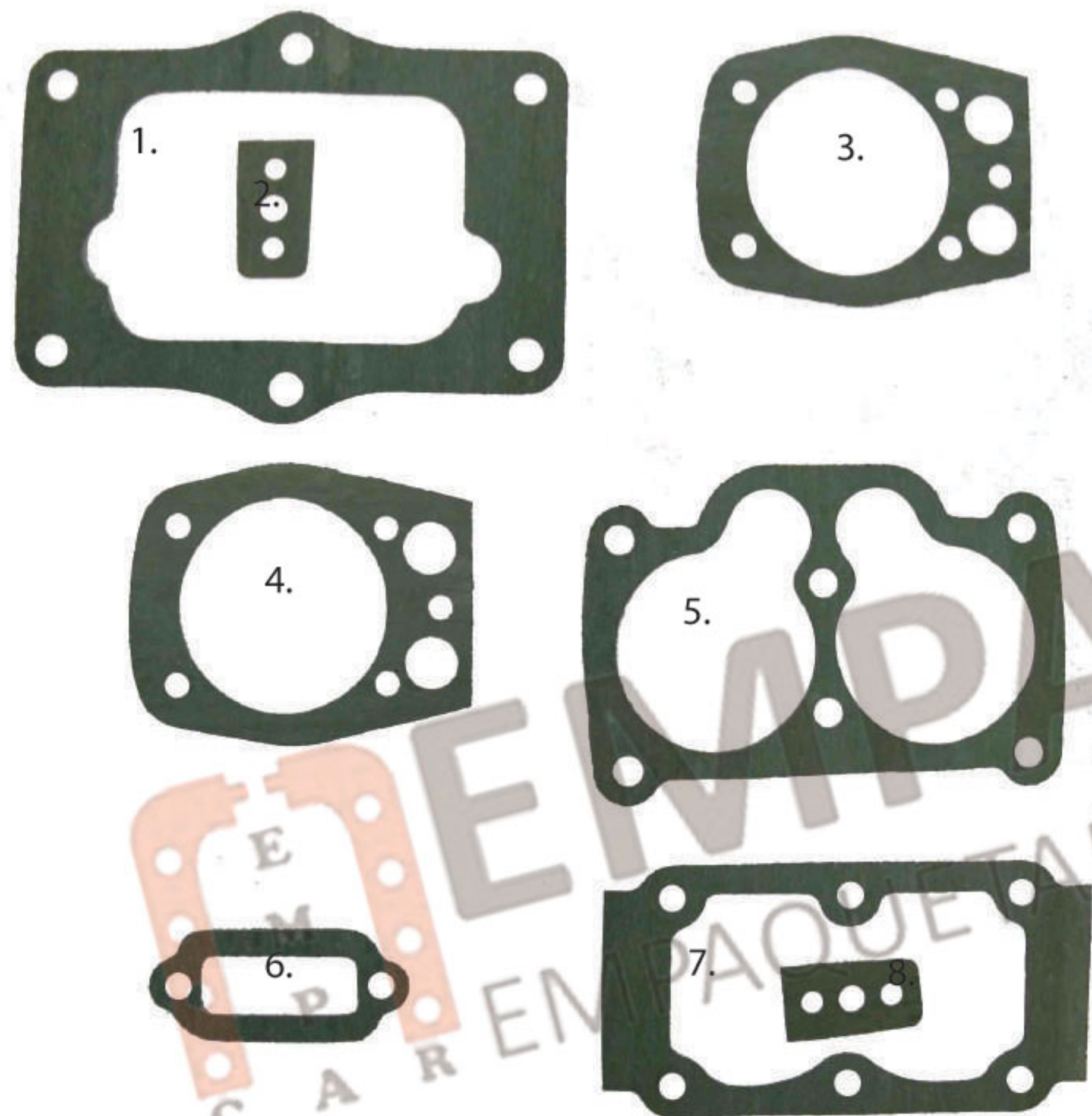

- 1. T - 3432
- 2. T - 3433
- 3. CO - 45 - 03237
- 4. CO - 45 - 03237
- 5. CO - 20 - 02355
- 6. CO - 20 - 01611 B
- 7. T - 3431
- 8. T - 3433

JO - 20 - 03431
FORD F600 - 700 - 800 - 900
TUFLO 501

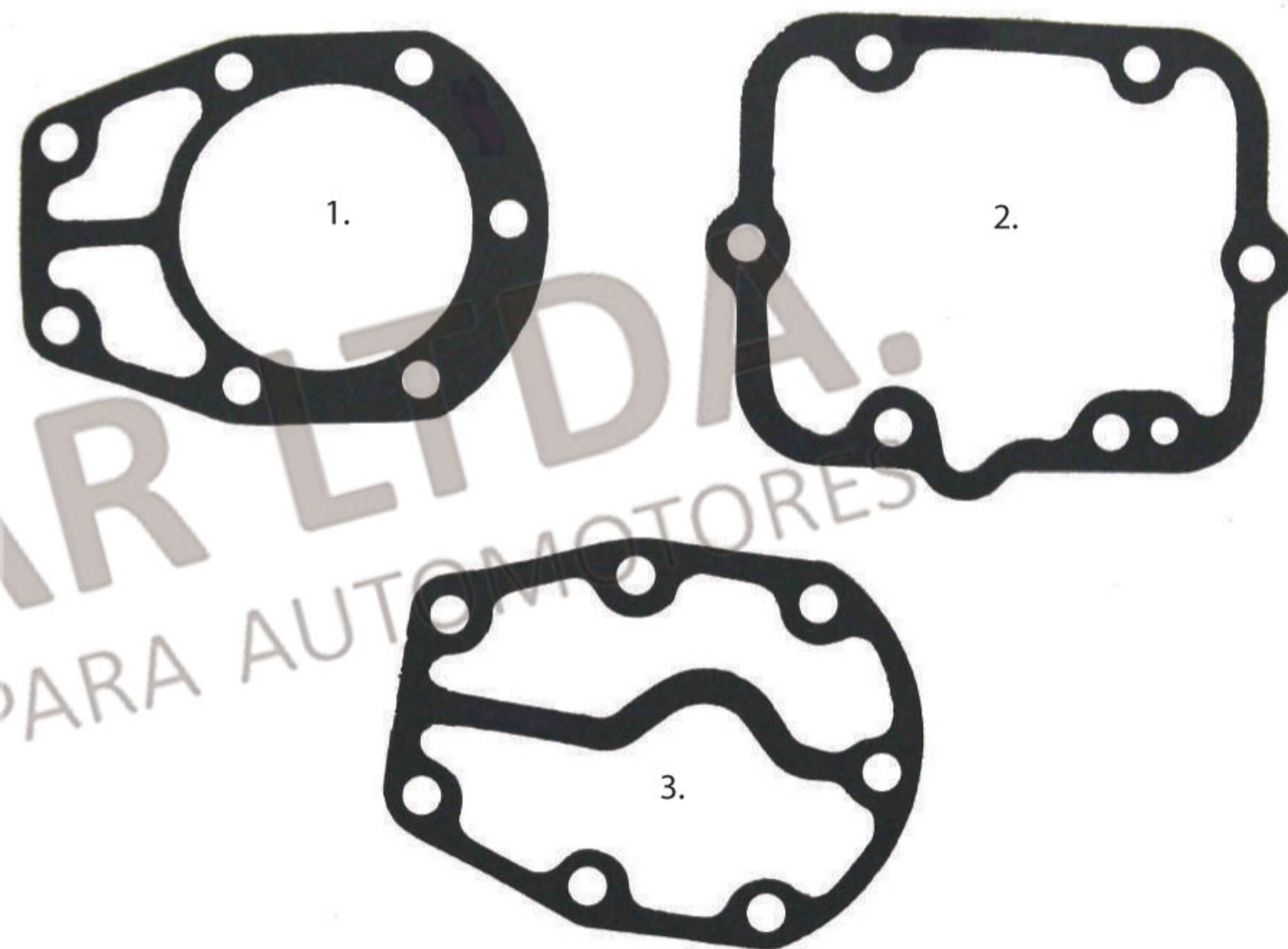

- 1. T - 3003
- 2. T - 3001
- 3. T - 3002

JO - 16 - 03001
DODGE MOPAR 1 PISTON



EMPACAR LTDA.

RETENEDORES Y EMPAQUETADURAS PARA AUTOMOTORES

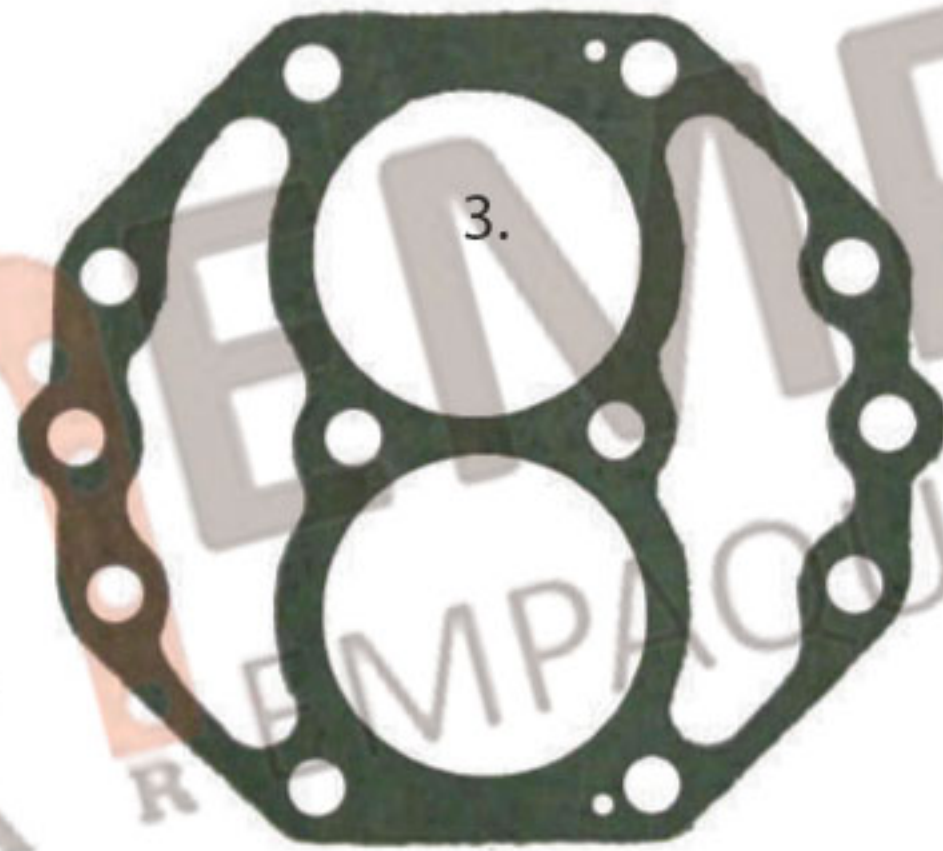
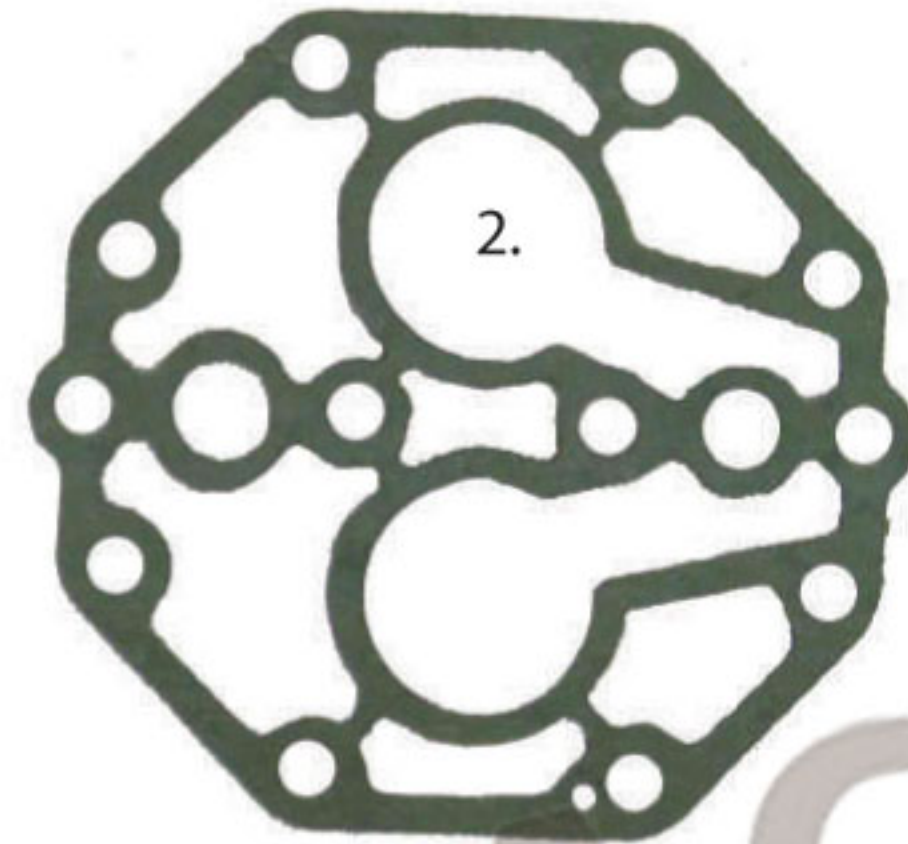
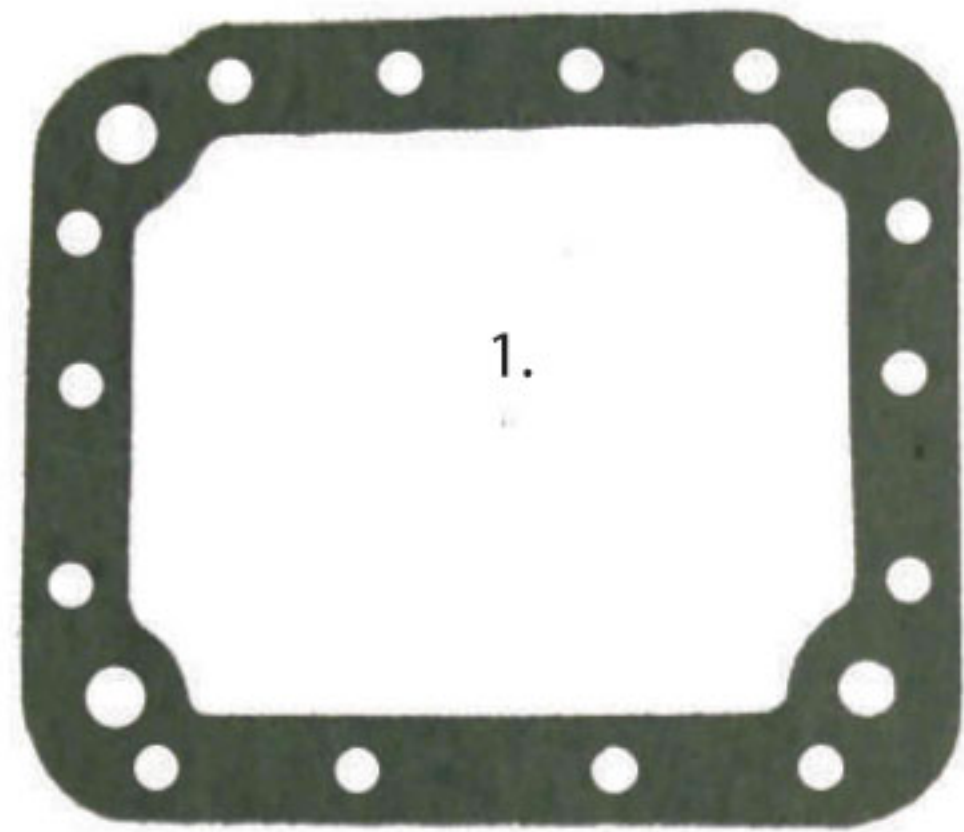

- 1. T - 3786
- 2. T - 3006
- 3. T - 3785

JO - 20 - 03785
MAYORCA

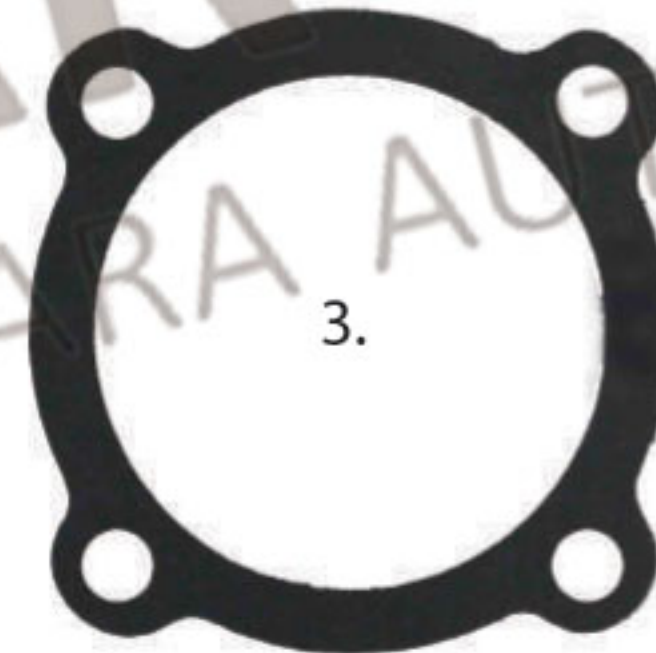

- 1. CO - 20 - 02229 A / (CANTIDAD 2)
- 2. CO - 20 - 03475
- 3. CO - 20 - 03474
- 4. T - 3433
- 5. CO - 20 - 00197 A

JO - 20 - 03433
FORD - MAZDA - CHEVROLET
- DODGE



EMPACAR LTDA.

RETENEDORES Y EMPAQUETADURAS PARA AUTOMOTORES

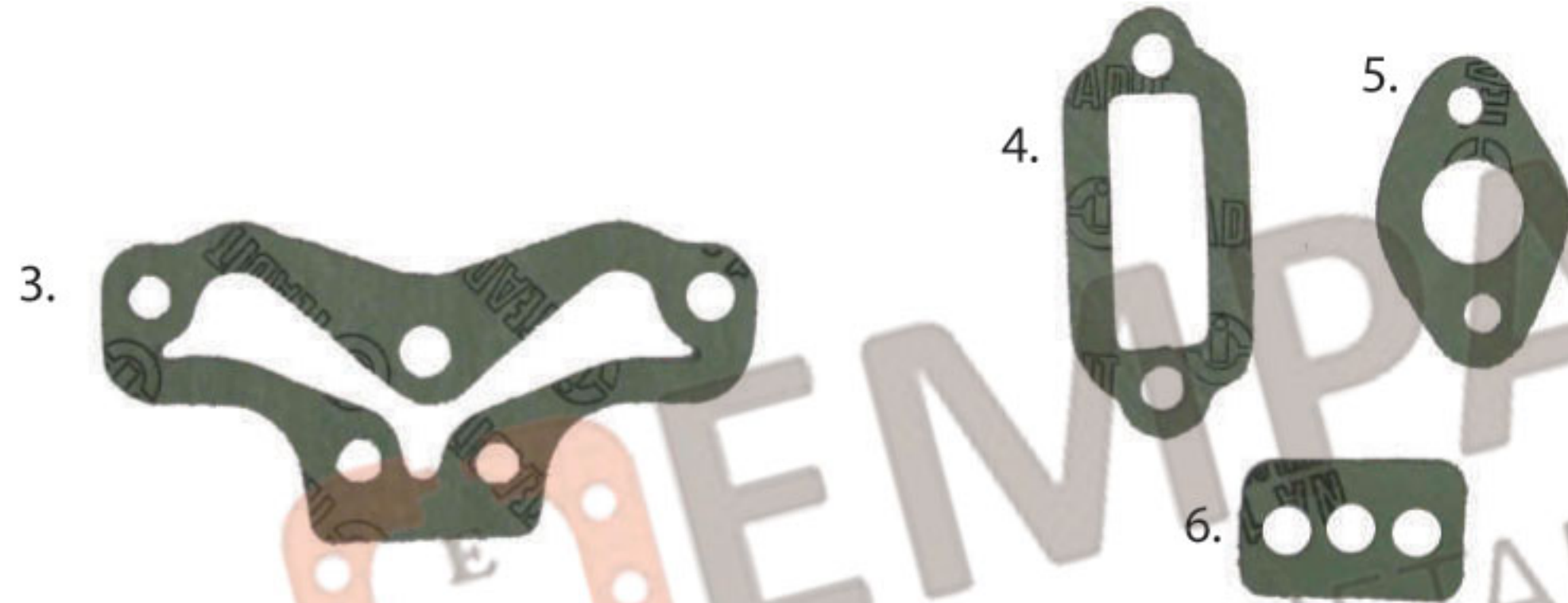
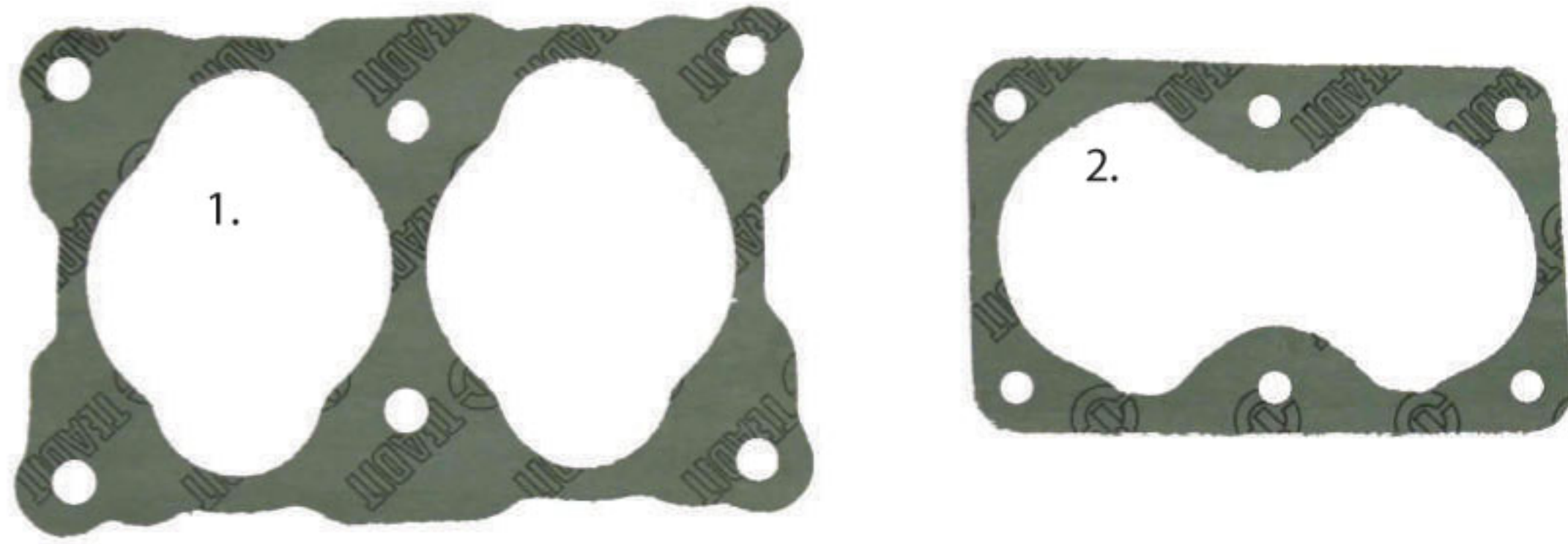

- 1. CO - 20 - 03229
- 2. CO - 20 - 01437
- 3. CO - 20 - 03226
- 4. CO - 20 - 01611 B
- 5. CO - 20 - 00197 A
- 6. CO - 20 - 01611 A

JO - 20 - 03229
FORD TUFLO 550

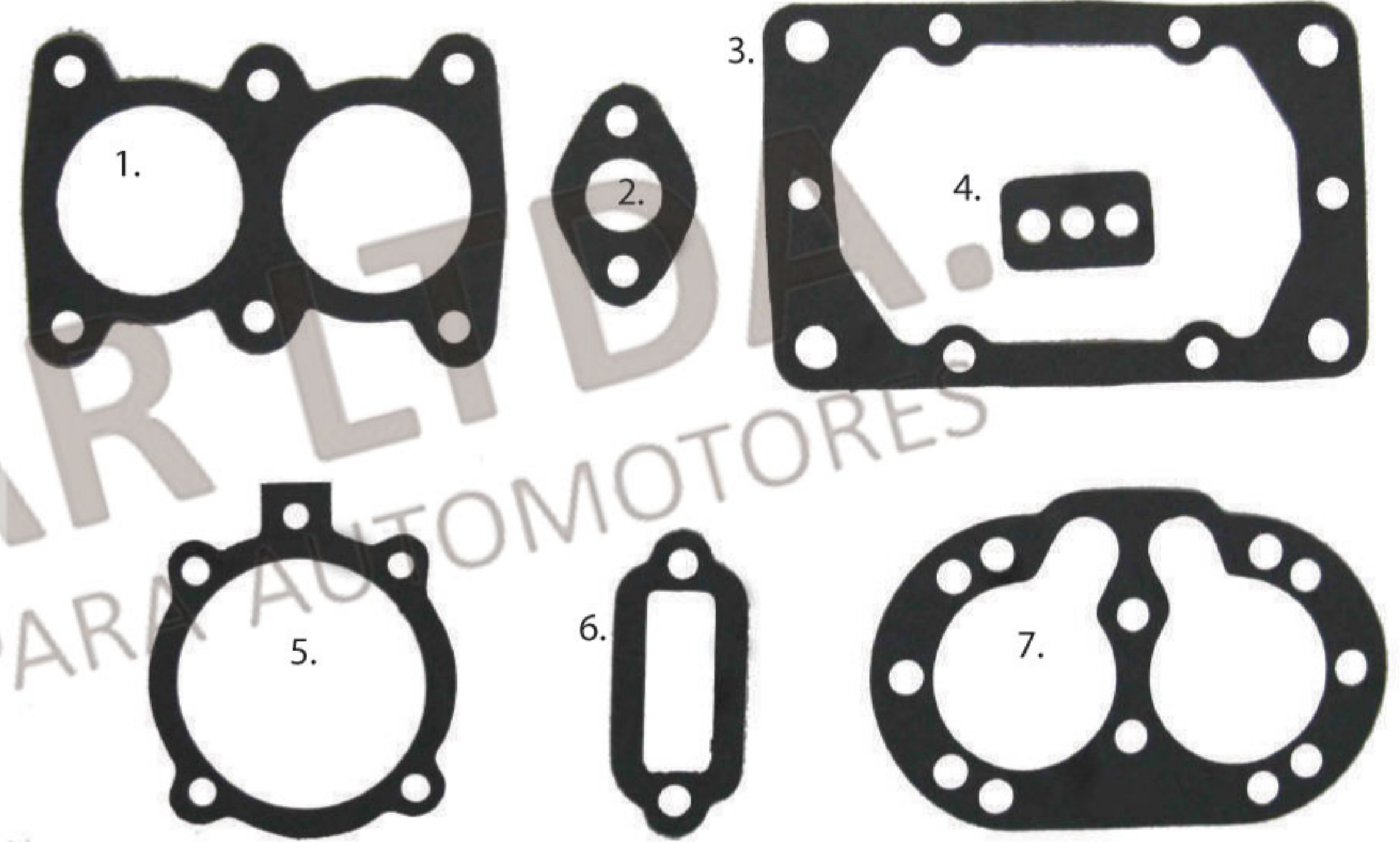

- 1. CO - 20 - 00198
- 2. CO - 20 - 00197 A (CANTIDAD 2)
- 3. CO - 20 - 00156
- 4. CO - 20 - 01611 A (CANTIDAD 2)
- 5. CO - 20 - 00197
- 6. CO - 20 - 01611 B (CANTIDAD 2)
- 7. CO - 20 - 00212

JO - 20 - 00156

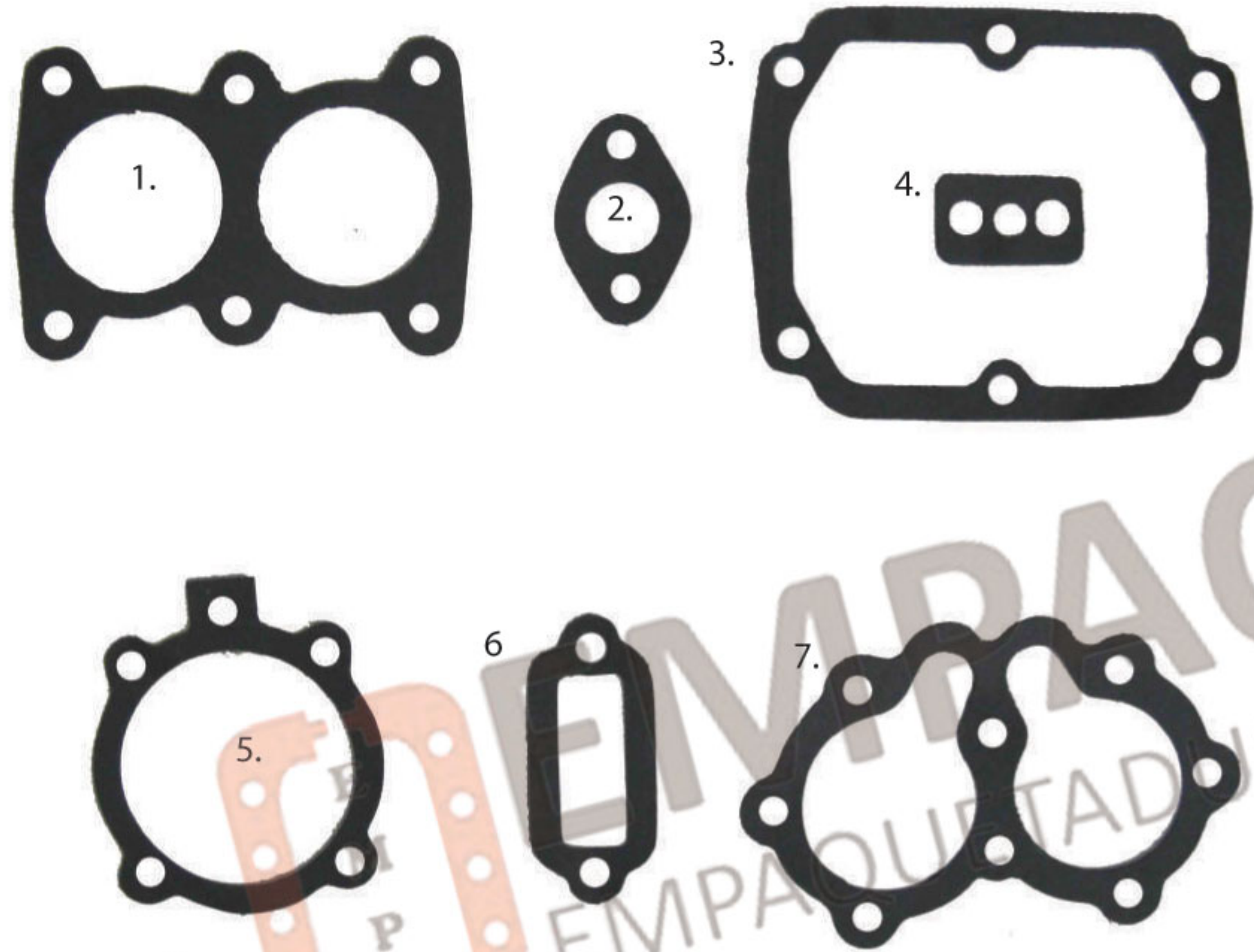

- 1. CO - 20 - 00198
- 2. CO - 20 - 00197 A (CANTIDAD 2)
- 3. CO - 20 - 00197 A
- 4. CO - 20 - 01611 A
- 5. CO - 20 - 00197
- 6. CO - 20 - 01611 B
- 7. CO - 20 - 00457

JO - 20 - 01611
FORD TUFLO 400
REFRIGERADO POR AIRE

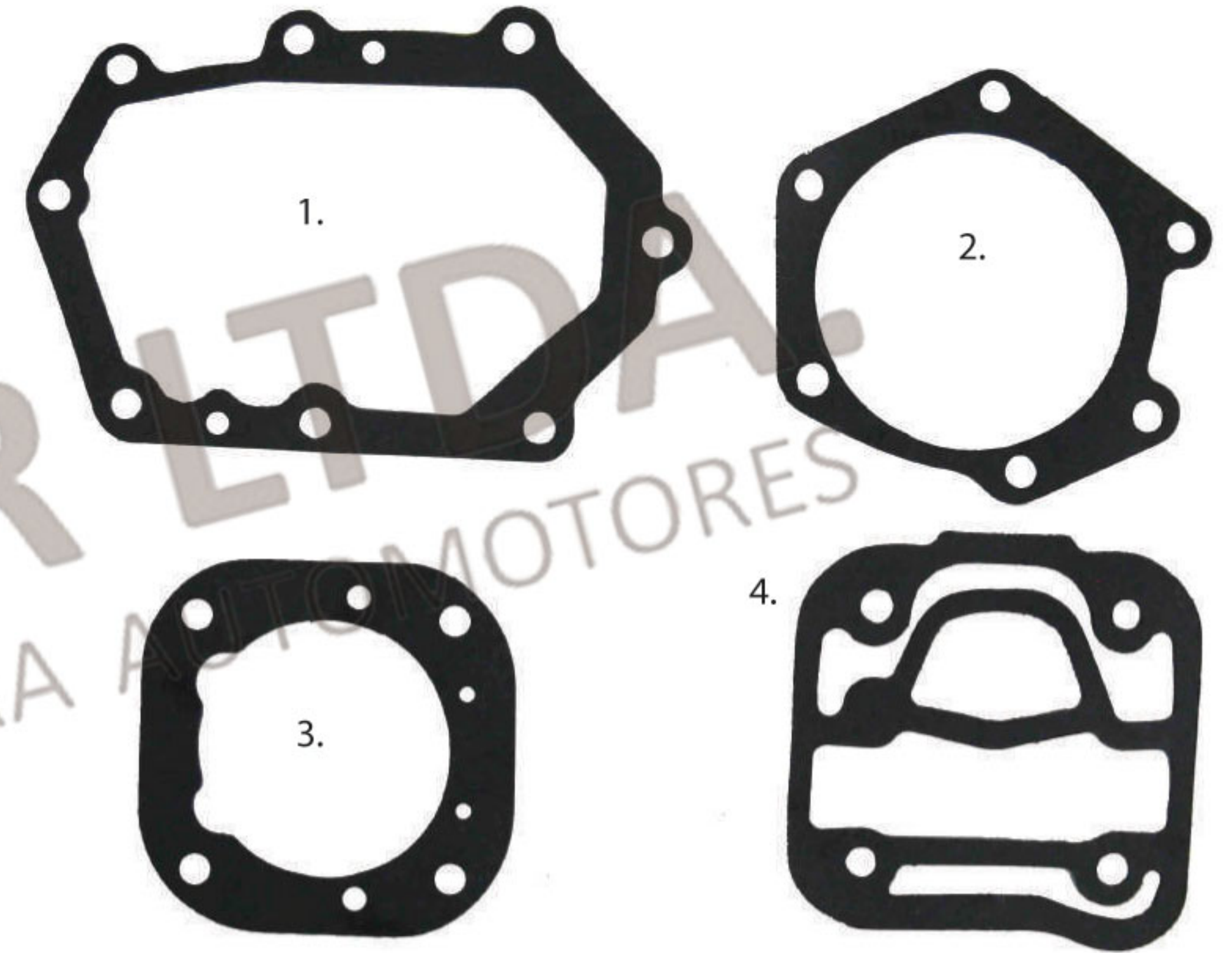

- 1. CO - 60 - 03645
- 2. CO - 60 - 03644
- 3. CO - 60 - 03646
- 4. CO - 60 - 03647

JO - 60 - 03646
PERKINS MOTOR FASE 5