



VITO

PROFESSIONAL TOOLS



www.vito-tools.pt



VITO

PROFESSIONAL TOOLS



www.vito-tools.pt





É com muita satisfação que lhe apresentamos o catálogo de ferramentas manuais para 2018.

Sermos líderes no nosso setor é uma distinção que muito nos orgulha. É uma homenagem ao trabalho que temos realizado com produtos de qualidade e uma equipa que se esforça diariamente por responder às necessidades de um mercado cada vez mais exigente.

Com 30 anos de experiência e uma vasta gama de produtos (ferramentas concebidas para trabalhos de precisão e exigência técnica) temos também um grande leque de acessórios e consumíveis para atividades diversas.

Porque boas combinações conduzem a bons resultados....

Vito, consigo todo o ano.

Con mucho gusto le presentamos el catálogo de herramientas manuales para 2018.

Ser líderes en nuestro sector es una distinción que nos llena de orgullo. Es un homenaje al trabajo que hemos realizado con productos de calidad y un equipo que se esfuerza diariamente por responder a las necesidades de un mercado cada vez más exigente.

Con 30 años de experiencia y una amplia gama de productos (herramientas diseñadas para trabajos de precisión y exigencia técnica) tenemos también una amplia gama de accesorios y consumibles para actividades diversas.

Porque buenas combinaciones conducen a buenos resultados...

Vito, consigo todo el año.

It is with great pleasure that we introduce you the hand tools catalogue for 2018.

Being leader in our industry it's a distinction that makes us all very proud. It is the recognition for all the hard work we have done with quality products and a team that strives daily to fulfill the needs of a market increasingly demanding.

With 30 years of experience and a wide range of products (especially designed tools for precision and technically exigent works) we also have a great variety of accessories and consumables for many other types of activities.

Because good combinations lead to great results...

VITO, with you the whole year.

C'est avec plaisir que nous vous présentons le catalogue d'outils à main pour 2018.

Être le leader dans notre secteur est une distinction qui nous rend très fiers. C'est la reconnaissance du dur travail avec des produits de qualité et une équipe qui fait tous les efforts jour-à-jour pour répondre aux besoins d'un marché de plus en plus exigeant.

Avec 30 ans d'expérience et une large gamme de produits (outils spécialement conçus pour les travaux de précision et d'exigence technique), nous disposons également d'une grande variété d'accessoires et de consommables pour de nombreux types de travaux.

Des bonnes combinaisons conduisent à d'excellents résultats ...

Vito, avec vous toute l'année.

Ferramentas manuais › Hand tools Herramientas manuales › Outils manuels	2
Construção e carpintaria › Construction and carpentry Construcción y carpintería › Construction et menuiserie	56
Pintura › Painting Peinture › Pintura	94
Canalização › Plumbing Plomería › Plomberie	100
Soldadura › Welding Soldadura › Soudure	104
Arrumação › Storage Almacenaje › Rangement	106
Escadas › Ladders Escaleras › Échelles	114
Ferragens e utilidades › Tools and utilities Ferretería y utensilios › Outils et utilitaires	120
Consumíveis e acessórios › Consumables and accessories Consumibles y accesorios › Consommables et accessoires	132
Auto	142
Planogramas › Planogram Planogramas › Planogramme	154

**Ferramentas
manuais**

Herramientas
manuales

Hand tools

Outils manuels



Carro de ferramentas - 221 peças
Carro de herramientas - 221 piezas
Tool roller cabinet - 221 pieces
Servante d'atelier - 221 pièces

CrV
Chrome
Vanadium



7 gavetas
7 cajones
7 drawers
7 tiroirs

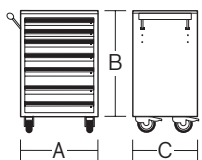

Ref.	A x B x C		Ean
VITF5G	760 x 1030 x 465 cm	1	5604612650186

Composição › Content

Contenido › Contenu

1



2



3

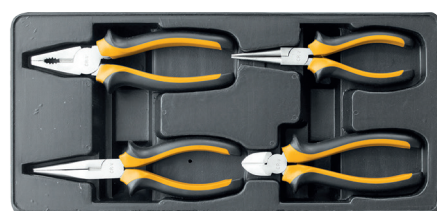

4

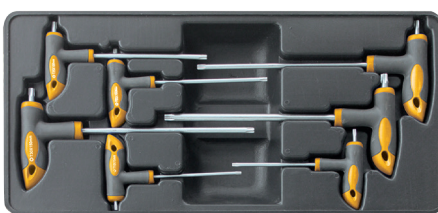

5

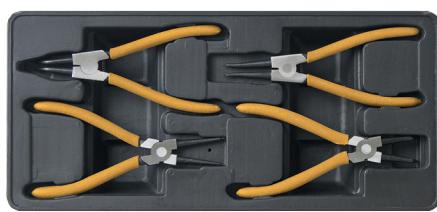

Caixa metálica com ferramentas - 88 peças

Caja metálica con herramientas - 88 piezas

Metallic tool box - 88 pieces

Coffret à outils en métal - 88 pièces

CrV
Chrome
Vanadium



Qtd.	Conteúdo	Contenido	Content	Contenu	Tamanho › Talla › Size › Taille
18	chaves de caixa 1/2"	laves vaso 1/2"	sockets 1/2"	douilles 1/2"	10 · 11 · 12 · 13 · 14 · 15 · 16 · 17 · 18 · 19 20 · 21 · 22 · 23 · 24 · 27 · 30 · 32 mm
1	chave roquete 1/2"	llave carraca 1/2"	ratchet handle 1/2"	clés a cliquet 1/2"	
1	alicate de pontas	alicate boca semiredonda recta	long nose plier	pince bec droite	165 mm
1	alicate universal	alicate universal	combination plier	pince universelle	180 mm
1	alicate corte lateral	alicate corte diagonal	side cutting plier	pince coupante de coté	155 mm
1	alicate bomba de água	alicate pico de loro	water pump plier	pince multiprise	255 mm
1	alicate de pressão	alicate del apretón	lock plier	pince étau	220 mm
1	fita métrica	fluxómetro	measuring tape	metre a ruban	19 mm x 3 m
10	lâminas para faca	cuchillas para cutter	blades for cutter	lames pour cutter	
2	prolongamentos	prolongamientos	extensions	extensions	75 · 125 mm
1	barra deslizante 1/2"	llave barra deslizando 1/2"	sliding bar 1/2"	clé à douille barre coulissante 1/2"	250 mm
1	chave cardan articulada	llave cardan articulada	rotation socket	clé à douilles cardan	4 · 4,5 · 5 · 5,5 · 6 · 7 · 8 · 9 · 10 · 11 · 12 · 18
12	chaves de caixa 1/4"	llaves vaso 1/4"	sockets 1/4"	douilles 1/4"	
1	chave roquete 1/4"	llave carraca 1/4"	ratchet handle 1/4"	clé à cliquet 1/4"	
6	chaves caixa bits 1/4"	llaves vaso bit 1/4"	sockets bits 1/4"	douilles embouts 1/4"	PH1 · PH2 · PZ1 · PZ2 · 4 mm · 6 mm
1	chave para bits	llave para bits	bit screwdriver	clé pour embouts	
3	chaves de fendas	destornilladores boca plana	slotted screwdrivers	tournevis lame plate	5 x 75 mm · 6 x 100 mm · 8 x 150 mm
2	chaves phillips	destornilladores phillips	phillips screwdrivers	tournevis phillips	PH1 x 7 mm · PH2 x 100 mm
12	chaves boca-luneta	llaves combinadas	combination spanners	clés mixtes	6 · 8 · 9 · 10 · 11 · 12 · 13 · 14 · 15 · 16 · 17 · 19 mm
9	chaves hexagonais	llaves allen	hex keys	clés hexagonales	1,5 · 2 · 2,5 · 3 · 4 · 5 · 6 · 8 · 10 mm
1	martelo carpinteiro	martillo carpinteiro	claw hammer	marteau menuisier	
1	serrote corte ferro	sierra corte hierro	hacksaw frame	scie à métaux	300 mm
1	Cortador com lâminas	cutter con cuchillas	utility knife with blades	cutter avec lames	

Ref.
VICMF88

Ean
1 5604612639693



Mala de ferramentas - 100 peças

Maleta de herramientas - 100 piezas

Tool box - 100 pieces

Coffret à outils - 100 pièces

CrV
 Chrome
 Vanadium

Qtd.	Conteúdo	Contenido	Content	Contenu	Tamanho › Talla › Size › Taille
11	chaves boca-lunetas	llaves combinadas fija-estrella	double open end spanner	clés plates	6 · 7 · 8 · 10 · 11 · 12 · 13 · 14 · 15 · 17 · 19 mm
2	chaves phillips	destornilladores phillips	phillips screwdrivers	tournevis phillips	PH2 x 40 · PH2 x 100 mm
2	chaves fenda	destornilladores boca plana	slotted screwdrivers	tournevis lame plate	6 x 40 · 6 x 100 mm
2	chaves roquete	llaves carraca	ratchet	clés a cliquet	1-4" · 1-2"
2	chaves de velas 1/2"	llaves de bujias 1/2"	socket wrench 1/2"	clés a bougies 1/2"	
2	chaves cardan articuladas	llaves cardan articuladas	joint sockets	clés a douille cardan	1-4" · 1-2"
6	chaves fenda	destornilladores boca plana	slotted screwdrivers	tournevis lame plate	6 · 8 · 10 · 11 · 12 · 13 mm
13	chaves caixa 1/2"	llaves vaso 1/2"	sockets 1/2"	douilles 1/2"	10 · 11 · 12 · 13 · 14 · 15 · 17 · 19 · 22 · 24 · 27 · 30 · 32 mm
6	chaves torx externas 1/4"	llaves torx 1/4"	external torx sockets 1/4"	douilles torx exterieur 1/4"	E4 · E5 · E6 · E7 · E8 · E10
7	chaves caixa torx 1/4"	llaves vaso torx 1/4"	torx sockets 1/4"	douilles torx 1/4"	T10 · T15 · T20 · T25 · T27 · T30
7	chaves caixa hexagonais 1/4"	llaves vaso allen 1/4"	hexagonal sockets 1/4"	douilles hexagonales 1/4"	H3 · H4 · H5 · H6 · H8 · H10 · H12
3	chaves caixa phillips 1/4"	llaves vaso phillips 1/4"	phillips sockets 1/4"	douilles phillips 1/4"	PH1 · PH2 · PH3
3	chaves caixa pozidriv 1/4"	llaves vaso pozidriv 1/4"	pozidriv sockets 1/4"	douilles pozidriv 1/4"	PZ1 · PZ2 · PZ3
4	chaves caixa fenda 1/4"	llaves vaso boca plana 1/4"	slotted sockets 1/4"	douilles lame plate 1/4"	4 · 5,5 · 6,5 · 7 mm
3	chaves allen	llaves allen	allen keys	clés allen	
12	chaves caixa hexagonais 1/4"	llaves vaso allen 1/4"	hexagonal sockets 1/4"	douilles hexagonales 1/4"	4 · 4,5 · 5 · 5,5 · 6 · 7 · 8 · 9 · 10 · 11 · 12 · 13 mm
1	chave para bits 1/4"	lave para bits 1/4"	bit key 1/4"	tournevis pour embouts 1/4"	
1	alicate universal	alicate universal	combination plier	pince universelle	
1	alicate pontas direitas	alicate boca semiredonda recta	long nose plier	pince bec droit	
1	alicate bomba de água	alicate pico de loro	water pump plier	pince multiprise	
1	prolongamento flexível	prolongamiento flexible	flexible extension	extension flexible	
3	prolongamentos	prolongamientos rígidos	rigid extensions	extensions rigides	
1	busca-pólos	busca-polos	voltage tester	tournevis testeur	
1	martelo	martillo	hammer	marteau	
2	barras deslizantes	llaves barra deslizante	sliding bars	clés a douille barre coulissante	
1	extensão	alargadera	extension	extension	
1	adaptador para bits	bit adaptador	bits adaptor	adaptateur	

Ref.
VIMF100Ean
3 5604612627041

Mala de ferramentas - 63 peças

Maleta de herramientas - 63 piezas

Tool box - 63 pieces

Coffret à outils - 63 pièces

CrV
 Chrome
 Vanadium

Qtd.	Conteúdo	Contenido	Content	Contenu	Tamanho › Talla › Size › Taille
1	alicate universal	alicate universal	combination plier	pince universelle	180 mm
1	alicate pontas direitas	alicate boca semiredonda recta	long nose plier	pince bec droit	160 mm
1	alicate corte lateral	alicate corte diagonal	diagonal plier	pince coupante de coté	160 mm
1	alicate bomba de água	alicate pico de loro	water pump plier	pince multiprise	245 mm
1	chave fenda	destornillador boca plana	slotted screwdriver	tournevis lame plate	100 mm
1	chaves phillips	destornillador phillips	phillips screwdrivers	tournevis phillips	PH2
3	bits pozidriv	bits pozidriv	bits pozidriv	embouts pozidriv	PZ1 · PZ2 · PZ3
3	bits phillips	bits phillips	bits phillips	embouts phillips	PH1 · PH2 · PH3
4	bits fenda	bits fenda	bits slotted	embouts lame plate	3 · 4 · 5 · 6 mm
5	bits hexagonais	bits hexagonales	bits hex	embouts hex	2 · 3 · 4 · 5 · 6 mm
4	bits torx	bits torx	bits torx	embouts torx	T10 · T20 · T30 · T40
1	adaptador 1/4"	adaptador 1/4"	adaptor 1/4"	adapteur 1/4"	25 mm
12	chaves caixa 1/4"	llaves vaso 1/4"	sockets 1/4"	douilles 1/4"	2 · 5 · 6 · 7 · 8 · 9 · 10 · 11 · 12 · 13 mm
1	extensão 1/4"	alargadera 1/4"	extension bar 1/4"	augmentateur 1/4"	75 mm
1	chave cardan articulada 1/4"	llave articulada 1/4"	universal joint 1/4"	clé à douille cardan 1/4"	
1	adaptador 1/4"	adaptador 1/4"	adaptor 1/4"	adapteur 1/4"	
1	chave para chaves de caixa 1/4"	destornillador para llaves vaso 1/4"	screwdriver socket handle 1/4"	tournevis pour douilles 1/4"	
1	chave roquete 1/4"	llave carraca 1/4"	ratchet handle 1/4"	clé à cliquet 1/4"	
10	chaves caixa 3/8"	llaves carraca 3/8"	sockets 3/8"	douilles 3/8"	10 · 11 · 12 · 13 · 14 · 15 · 17 · 19 · 21 · 22 mm
2	chaves de velas 3/8"	llaves de bujias 3/8"	llaves bugias 3/8"	douilles pour bougies 3/8"	16 · 21 mm
2	extensões 3/8"	alargaderas 3/8"	extensions 3/8"	extensions 3/8"	75 · 125 mm
1	chave cardan articulada 3/8"	llave articulada 3/8"	universal joint 3/8"	clé à douille cardan 3/8"	
1	chave roquete 3/8"	llave carraca 3/8"	ratchet handle 3/8"	clé à cliquet 3/8"	
5	chaves boca	llaves fija	double open end spanners	cles plates	6 x 7 · 8 x 9 · 10 x 11 · 12 x 13 · 14 x 15 mm

 Ref.
 VIMF63

 Ean
 4 5604612650131

Mala de ferramentas - 79 peças

Maleta de herramientas - 79 piezas

Tool box - 79 pieces

Coffret à outils - 79 pièces

CrV
Chrome
Vanadium



Qtd.	Conteúdo	Contenido	Content	Contenu	Tamanho › Talla › Size › Taille
11	chaves caixa 3/8"	llaves vaso 3/8"	sockets 3/8"	douilles 3/8"	10 · 11 · 12 · 13 · 14 · 15 · 16 · 17 · 19 · 21 · 22 mm
9	chaves caixa 1/4"	llaves vaso 1/4"	sockets 1/4"	douilles 1/4"	4 · 5 · 6 · 7 · 8 · 9 · 10 · 11 · 12 mm
1	extensão 3/8"	alargadera 3/8"	extension 3/8"	extension 3/8	75 mm
1	chave cardan articulada 3/8"	llave articulada 3/8"	universal joint 3/8"	clé à douille cardan 3/8"	
1	chave roquete 3/8"	llave carraca 3/8"	ratchet handle 3/8"	clé à cliquet 3/8"	
1	adaptador 3/8	adaptador 3/8"	adaptor 3/8	adaptateur 3/8"	1/4"
8	chaves boca-luneta	llaves combinadas fija-estrella	combination spanners	clés plate	8 · 10 · 11 · 12 · 13 · 14 · 17 · 19 mm
10	chaves hexagonais	llaves allen	hexagonal key set	clés hexagonales	1,5 · 2 · 2,5 · 3 · 4 · 5 · 5,5 · 6 · 8 · 10 mm
4	bits fenda	bits boca plana	slotted bits	embouts lame plate	3 · 4 · 5 · 6 mm
3	bits phillips	bits phillips	phillips bits	embouts phillips	PH1 · PH2 · PH3
3	bits pozidriv	bits pozidriv	pozidriv bits	embouts pozidriv	PZ1 · PZ2 · PZ3
5	bits hexagonais	bits hexagonales	hex bits	embouts hex	H2 · H3 · H4 · H5 · H6
4	bits torx	bits torx	torx bits	embouts torx	T10 · T20 · T30 · T40
1	adaptador 1/4"	adaptador 1/4"	adaptor 1/4"	adaptateur 1/4"	25 mm
1	mini chave roquete 1/4"	mini llave carraca 1/4"	mini ratchet handle 1/4"	mini clé à cliquet 1/4"	
1	tesoura	tijera	scissors	ciseaux	200 mm
1	chave fenda	destornillador boca plana	slotted screwdriver	tournevis lame plate	6 x 100 mm
2	chaves phillips	destornilladores phillips	phillips screwdrivers	tournevis phillips	PH1 x 75mm · PH2 x 100 mm
1	chave para bits	llave para bits	bit key	tournevis pour embouts	
4	chaves de precisão	llaves de precisión	precision screwdrivers	clés de precision	
1	busca-pólos	destornillador probador	voltage tester	tournevis testeur	
1	serrote corte ferro	sierra corte hierro	hacksaw	scie à métaux	
1	cortador metálico	cuter	utility knife 18 mm	cutter 18mm	18 mm
1	alicate universal	alicate universal	combination plier	pince universelle	180 mm
1	alicate bomba de água	alicate pico de loro	water pump plier	pince multiprise	245 mm
1	martelo	martillo	hammer	marteau	300 g
1	fita métrica	fluxómetro	measuring tape	metre à ruban	3 m

Ref.
VIMF79

Ean
4 5604612650148



Mala de ferramentas em nylon para canalizador - 17 peças

Bolsa con ferramentas en nylon para fontanero - 17 piezas

Plumber nylon tools bag - 17 pieces

Sac à outils en nylon pour plombier - 17 pièces

CrV
Chrome
Vanadium



Qtd.	Conteúdo	Contenido	Content	Contenu	Tamanho › Talla › Size › Taille
1	mala para ferramentas	caja para herramienta	tool box	boîte à outils	21"
1	chave bico papagaio	llave para tubos modelo germany	groovelock key	clé de verrouillage	10-1/2" - 265mm
1	chave stillson tipo ridgid	llave stillson tipo ridgid	ridgid stillson key	Clé stillson ridgid	12"
1	chave tipo sueco	llave ajustable para tubos	bent nose pipe wrench	clé à tube cintrée	1,5"
1	chave inglesa	llave inglesa	adjustable wrench	Clé ajustable	300 mm
1	conjunto 8 chaves multiusos	juego de 8 llaves multiusos	set of 8 multipurpose keys	Jeu de 8 clés multifonctions	
1	lima redonda murça	lima redonda fina	round file smooth	lime ronde mi-douce	8"
1	serrote corte de ferro	serrote corte hierro ajustable	hacksaw frame	scie à métaux	
1	corta tubos	corta tubos	pipe cutter	coupe-tubes	42 mm
1	tarraxa em aço para tubo pvc	tarrajas de acero para tubo pvc	steel ratchet pvc	filière en acier pour tuyau en pvc	1" - 3/4" - 1/2"
1	conjunto 4 brocas craneanas	juego 4 estuche coronas	set of 4 carbide hole saw	jeu de 4 trépan pour carrelage	33 · 53 · 63 · 73
1	fita métrica revestida	flexometro revestido n	magnetic tape measure	mètre a ruban	5 m x 19 mm
1	pistola mastique	pistola de silicona	caulking gun	pistolet pour silicone	
1	luva nitrilica anti-deslizante	guante nitrilo antideslizante	nitrile coated glove	gants de travail en nitrile antidérapant	9"
1	maçarico sem isqueiro	soplete sin encendedor	blow torch traditional ignition	lampe à souder sans allumeur	
1	cartucho de gás	cartucho de gas	gas cartridge	cartouche de gaz	190 gr
1	chave lavatório	chave lavatorio	basin wrench	clé pour lavabo	

Ref.
VIMCANAL

Ean
1 5604612665753



Mala de ferramentas - 11 peças

Maleta de herramientas - 11 piezas

Tool box - 11 pieces

Coffret à outils - 11 pièces

CrV
Chrome
Vanadium



Qtd.	Conteúdo	Contenido	Content	Contenu	Tamanho › Talla › Size › Taille
1	mala para ferramentas	caja para herramienta	tool box	boîte à outils	16"
1	lanterna anti-choque led	linterna anti-choque led	anti-chock led flashlight	lampe de poche led anti-choc	
1	fita métrica	flexómetro	tape measure	mètre ruban	3 m x 16 mm
1	chave combinada fenda/phillips	destornillador boca plana/phillips	phillips/combined screwdriver	tournevis Phillips	
1	óleo wd-40	óleo wd-40	wd-40 lubricant	lubrifiant wd-40	
1	luva nitrílica	guante de nitrilo	nitrile coated glove	gant en nitrile	9"
1	martelo	martillo	hammer	marteau	
1	alicate universal	alicate universal	universal plier	pince universel	150 mm
1	cortador com lâminas	cutter con cuchillas	utility knife with blades	cutter avec lames	9 mm
1	lápiz	lápiz	pencil	crayon	
1	busca-pólos	destornillador	voltage tester	tournevis testeur	

Ref.
VIMFH11P

Ean
1 5604612665265



Mala em nylon com ferramentas para bricolage - 11 peças

Bolsa en nylon con herramientas para la bricolaje - 11 piezas

Nylon bag with DIY tools - 11 pieces

Sac en nylon avec des outils pour le bricolage - 11 pièces

CrV
Chrome
Vanadium



Qtd.	Conteúdo	Contenido	Content	Contenu	Tamanho › Talla › Size › Taille
1	mala de nylon para ferramentas	mala de nylon para herramientas	nylon tool pouch	sac en nylon pour outillage	
1	mini serrote	mini sierra	mini hackshaw	mini scie	
1	lubrificante multiusos	lubrificante multiusos	multipurpose lubricant	lubrifiant multi-usages	400 ml
1	chave combinada fenda/phillips	destornillador combinado boca plana/phillips	combined slotted/phillips screwdriver	tournevis combinée lame plate/phillips	
1	alicate universal	alicate universal	combination plier	pince universelle	150 mm
1	alicate pontas direitas	alicate boca semiredonda recta	long nose plier	pince bec droit	150 mm
1	chave inglesa cabo bimatéria	llave inglesa mango bimatéria	adjustable wrench	clé à mollette avec graduation	200 mm
1	cortador metálico	cutter metálico	metal retractable utility knife	cutter métallique	9 mm
1	par de luvas ultrafinas em PU	par de guantes ultrafina en pu	pu ultra thin gloves	gants très fine en PU	10"
1	fita métrica basic	flexómetro basic	measure tape	mètre à ruban	5 m x 19 mm
1	lanterna anti-choque	linterna anti-choque	shockproof flashlight	lampe torche antichoc	

Ref.
VIMNFB11

Ean
1 5604612666873

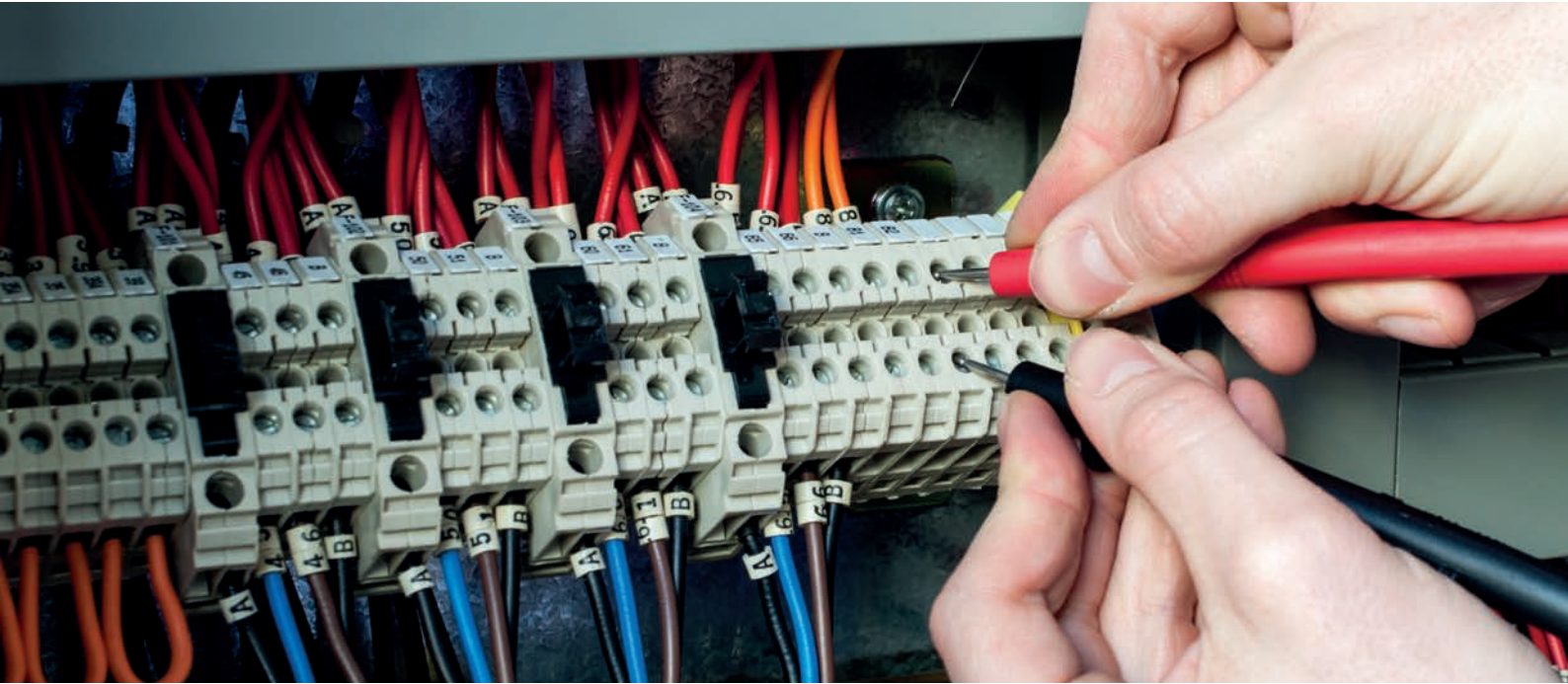

Mala de nylon com ferramentas para electricista - 12 peças

Bolsa en nylon con herramientas de electricista - 12 piezas

Nylon bag with electrician tools - 12 pieces

Sac en nylon avec des outils d'électricien - 12 pièces

CrV
Chrome
Vanadium



Qtd.	Conteúdo	Contenido	Content	Contenu	Tamanho › Talla › Size › Taille
1	mala de nylon para ferramentas	mala de nylon para herramientas	nylon tool pouch	sac en nylon pour outillage	
1	alicate universal isolado VDE	alicate universal aislado VDE	combination plier VDE	pince universelle isolée VDE	180 mm
1	alicate corte lateral isolado VDE	alicate corte diagonal aislado VDE	side cutting plier VDE	pince coupante de côté isolée VDE	160 mm
1	alicate descamar fio isolado VDE	alicate pelacables aislado VDE	wire snip plier vde VDE	pince à dénuder manuelle isolée VDE	160 mm
1	chave de fenda isolada VDE	llave boca plana aislada VDE	electrician slotted screwdriver VDE	tournevis lame plate isolée VDE	4,0 x 100 mm
2	chaves Phillips isoladas VDE	llaves hillips aislada VDE	electrician phillips screwdriver VDE	tournevis phillips isolée VDE	PH1 x 80 mm PH3 x 150mm
1	busca-pólos grande	probador grande	large voltage tester	tournevis testeur grand modèle	
1	fita métrica basic	flexómetro básico	tape measure	mètre à ruban	19 mm x 5 m
3	fitas isoladoras	cintas aislantes	pvc insulation tape	rubans adhésifs isolants	19 mm x 20 m
1	multímetro digital	multímetro digital	digital multimeter	multimètre numérique	

Ref.
VIMNFE



Ean

1 5604612661793



Conjunto de 14 chaves de caixa › Set of 14 socket wrenches

Juego de 14 llaves carraca › Jeu de 14 clés à douille

CrV
Chrome
Vanadium

Qtd.	Conteúdo	Contenido	Content	Contenu	Tamanho › Tamaño › Size › Taille
1	chave roquete 3/4"	llave carraca 3/4"	ratchet handle 3/4"	clé a cliquet 3/4"	
10	chaves caixa 3/4"	llaves vaso 3/4"	socket wrenches 3/4"	clés à douilles 3/4"	22 · 24 · 27 · 30 · 32 · 36 · 38 · 41 · 46 · 50 mm
2	extensões	alargadores	extension bars	rallonges pour clé à cliquet	100 · 200 mm
1	barra	barra	bar	barre	450 mm

Ref.	Ean
VIJR14	1 5604612642228

Conjunto de 15 chaves de caixa › Set of 15 socket wrenches

Juego de 15 llaves carraca › Jeu de 15 clés à douille

CrV
Chrome
Vanadium

Qtd.	Conteúdo	Contenido	Content	Contenu	Tamanho › Talla › Size › Taille
1	chave roquete 1"	llave carraca 1"	ratchet handle 1"	clé a cliquet 1"	
10	chaves caixa 1"	llaves vaso 1"	socket wrenches 1"	clés à douilles 1"	36 · 41 · 46 · 50 · 55 · 60 · 65 · 70 · 75 · 80 mm
2	extensões	alargadores	extension bars	rallonges pour clé à cliquet	200 · 400 mm
1	barra	barra	bar	barre	550 mm
1	cabeça deslizante	cabeza deslizante	sliding head	tête coulissante	

Ref.	Ean
VIJR15	1 5604612642235

Conjunto de 94 chaves de roquete

Juego de 94 llaves carraca

Set of 94 socket wrenches

Jeu de 94 clés à douilles

CrV
Chrome
Vanadium

Qtd.	Conteúdo	Contenido	Content	Contenu	Tamanho › Talla › Size › Taille
1	chave roquete 1/2"	llave carraca 1/2"	ratchet handle 1/2"	clé a cliquet 1/2"	
1	chave roquete 1/4"	llave carraca 1/4"	ratchet handle 1/4"	clé a cliquet 1/4"	
18	chaves caixa 1/2"	llaves vaso 1/2"	socket wrenches 1/2"	clés à douilles 1/2"	10 · 11 · 12 · 13 · 14 · 15 · 16 · 17 · 18 · 19 20 · 21 · 22 · 23 · 24 · 27 · 30 · 32 mm
13	chaves caixa 1/4"	llaves vaso 1/4"	socket wrenches 1/4"	clés à douilles 1/4"	4 · 4.5 · 5 · 5.5 · 6 · 7 · 8 · 9 · 10 · 11 · 12 · 13 · 14 mm
2	barras deslizantes	barras deslizantes	sliding bars	barres deslizantes	110 · 255 mm
3	extensões	alargadores	extension bars	rallonges pour clé à cliquet	50 · 100 · 125 mm
1	prolongamento flexível	alargadera flexible	flexible estension	extension flexible	145 mm
3	chaves caixa fenda 1/4"	llaves vaso fenda 1/4"	socket bits slotted 1/4"	clés à douille lame plate 1/4"	4 · 5.5 · 7 mm
2	chaves caixa phillips 1/4"	llaves vaso phillips 1/4"	socket bits phillips 1/4"	clés à douille phillips 1/4"	PH1 · PH2
4	chaves caixa hexagonais 1/4"	llaves vaso allen 1/4"	socket bits hexagonal 1/4"	clés à douille hexagonales 1/4"	H3 · H4 · H5 · H6
6	chaves caixa torx 1/4"	llaves vaso torx 1/4"	socket bits torx 1/4"	clés à douille torx 1/4"	T8 · T10 · T15 · T20 · T25 · T30
2	chaves caixa pozidriv 1/4"	llaves vaso pozidrive 1/4"	socket bits pozidriv 1/4"	clés à douille pozidriv 1/4"	PZ1 · PZ2
8	chaves fundas 1/4"	llaves vaso 1/4"	deep sockets 1/4"	douilles longues 1/4"	6 · 7 · 8 · 9 · 10 · 11 · 12 · 13 mm
4	chaves fundas 1/2"	llaves vaso 1/2"	deep sockets 1/2"	douilles longues 1/2"	14 · 15 · 17 · 19 mm
3	chaves hexagonais	llaves hexagonales	hexagonal keys	clés hexagonales	
2	chaves de velas 1/2"	llaves de bujias 1/2"	socket wrenches 1/2"	clés à bougies 1/2"	
2	chaves cardan	llaves cardan	joint socket	clés à douille cardan	
1	chave bits 1/4"	llave para bits 1/4"	bit key 1/4"	tournevis pour embouts 1/4"	
3	bits fenda	bits fenda	slotted bits	embouts lame plate	8 · 10 · 12 mm
2	bits pozidrive	bits pozidrive	pozidriv bits	embouts pozidriv bits	PZ3 · PZ4
2	bits phillips	bits phillips	phillips bits	embouts phillips bits	PH3 · PH4
4	bits torx	bits torx	torx bits	emboutstox bits	T40 · T45 · T50 · T55
4	bits hexagonais	bits hexagonales	hexagonal bits	embouts hexagonales	H8 · H10 · H12 · H14
2	adaptadores	adaptadores	adaptors	adaptateus	

Ref.
VIJR94Ean
3 5604612018054



Conjunto de 46 chaves de roquete

Juego de 46 llaves carraca

Set of 46 socket wrenches

Jeu de 46 clés à douilles

CrV
Chrome
Vanadium



Qtd.	Conteúdo	Contenido	Content	Contenu	Tamanho › Talla › Size › Taille
1	chave roquete 1/4"	llave carraca 1/4"	ratchet handle 1/4"	clé a cliquet 1/4"	
13	chaves caixa 1/4"	llaves vaso 1/4"	socket wrenches 1/4"	clés à douilles 1/4"	4 · 4.5 · 5 · 5.5 · 6 · 7 · 8 · 9 · 10 · 11 · 12 · 13 · 14 mm
2	extensões	alargadores	extension bars	rallonges pour clé à cliquet	50 · 100 mm
1	prolongamento flexível	alargadera flexível	flexible extension	extension flexible	145 mm
1	barra deslizante	barra deslizante	sliding bar	barre coulissante	110 mm
6	chaves caixa hexagonais 1/4"	llaves vaso allen 1/4"	socket bits hexagonal 1/4"	clés à douille hexagonales 1/4"	H3 · H4 · H5 · H6 · H7 · h8
3	chaves caixa pozidriv 1/4"	llaves vaso pozidrive 1/4"	socket bits pozidriv 1/4"	clés à douille pozidriv 1/4"	PZ1 · PZ2 · PZ3
3	chaves caixa fenda 1/4"	llaves vaso fenda 1/4"	socket bits slotted 1/4"	clés à douille lame plate 1/4"	4 · 5.5 · 7 mm
3	chaves caixa phillips 1/4"	llaves vaso phillips 1/4"	socket bits phillips 1/4"	clés à douille phillips 1/4"	PH1 · PH2 · PH3
6	chaves caixa torx 1/4"	llaves vaso torx 1/4"	socket bits torx 1/4"	clés à douille torx 1/4"	T10 · T15 · T20 · T25 · T30 · T40
1	chave cardan articulada	llave cardan articulada	joint socket	douille articulée cardan	
1	chave para bits	llave para punta	bit key	tournevis pour embouts	
1	adaptador para bits	adaptador para puntas	bit adaptor	adaptateur pour embouts	
4	chaves hexagonais	llaves allen	hexagonal keys	clés hexagonales	

Ref.
VIJR46

Ean
15 5604612025335

Conjunto de 24 chaves de roquete

Juego de 24 llaves carraca

Set of 24 socket wrenches

Jeu de 24 clés à douilles

CrV
Chrome
Vanadium

Qtd.	Conteúdo	Contenido	Content	Contenu	Tamanho › Talla › Size › Taille
1	chave roquete 1/2"	llave carraca 1/2"	ratchet handle 1/2"	clé à cliquet 1/2"	
18	chaves caixa 1/2"	llaves vaso 1/2"	socket wrenches 1/2"	clés à douilles 1/2"	10 · 11 · 12 · 13 · 14 · 15 · 16 · 17 · 18 · 19 · 20 · 21 · 22 · 23 · 24 · 30 · 32 mm
2	extensões	alargadores	extension bars	rallonges pour clé à cliquet	125 mm · 250 mm
1	barra deslizante	barra deslizante	sliding bar	barre coulissante	250 mm
1	chave de aperto	llave de apriete	fastening wrench	clé tournevis	360 mm
1	chave cardan articulada	llave cardan articulada	joint socket	douille articulée cardan	

Ref.	Ean
VIJR24	4 5604612018047

Conjunto de 21 chaves de roquete

Juego de 21 llaves carraca

Set of 21 socket wrenches

Jeu de 21 clés à douilles

CrV
Chrome
Vanadium

Qtd.	Conteúdo	Contenido	Content	Contenu	Tamanho › Talla › Size › Taille
1	chave roquete 1/2"	llave carraca 1/2"	ratchet handle 1/2"	clé à cliquet 1/2"	
16	chaves caixa 1/2"	llaves vaso 1/2"	sockets 1/2"	douilles 1/2"	10 · 11 · 12 · 13 · 14 · 15 · 16 · 17 · 18 · 19 · 21 · 22 · 24 · 27 · 30 · 32 mm
2	extensões	alargadores	extension bars	rallonges pour clé à cliquet	75 mm · 125 mm
1	adaptador	adaptador	adaptor	adaptateur	
1	chave cardan articulada	llave cardan articulada	joint socket	clé a douille cardan	

Ref.	Ean
VIJR21	6 5604612018030



Jogo de chaves com roquete
 Juego de llaves vaso con carraca
Socket set with ratchet handle
 Jeu de douilles avec clé à cliquet



CrV
 Chrome
 Vanadium

1/2"

- 10 mm
- 11 mm
- 12 mm
- 13 mm
- 14 mm
- 15 mm
- 17 mm
- 19 mm
- 22 mm
- 24 mm



Ref. VIJR1211  Ean 5604612672560

Jogo de chaves com roquete
 Juego de llaves vaso con carraca
Socket set with ratchet handle
 Jeu de douilles avec clé à cliquet



CrV
 Chrome
 Vanadium

1/4"

- 4 mm
- 5 mm
- 6 mm
- 7 mm
- 8 mm
- 9 mm
- 10 mm
- 11 mm
- 12 mm
- 13 mm



Ref. VIJR1411  Ean 5604612672577

Chave roquete › Ratchet handle

Llave carraca › Clé à cliquet

CrV
Chrome
Vanadium

1/4"



Ref.	Dim.		Ean
VICR14	1/4 "	10	5604612034948

Chave roquete › Ratchet handle

Llave carraca › Clé à cliquet

CrV
Chrome
Vanadium

1/2"



Ref.	Dim.		Ean
VICR12	1/2 "	10	5604612034931

Extensão › Extension bar

Alargador de llave › Rallonge pour clé à cliquet

CrV
Chrome
Vanadium

1/2"



Ref.	Dim.		Ean
VIE125	125 mm	10	5604612034917
VIE250	250 mm	10	5604612034924

Barra deslizante › Sliding bar

Barra deslizante › Barre coulissante

CrV
Chrome
Vanadium

1/2"



Ref.	Dim.		Ean
VIBD12	250 mm	10	5604612034900

Chave de velas para roquete

Llave de vaso para bujías

Spark plug socket

Douille pour bougies

CrV
Chrome
Vanadium

1/2"



Ref.	Dim.		Ean
VICVR16	16 mm	10	5604612640118
VICVR21	21 mm	10	5604612640101

Chave caixa › Socket wrench

Llave vaso › Clé à douille

CrV
Chrome
Vanadium

1/2"



Ref.	Dim.		Ean
VIC128	8 mm	10	5604612034696
VIC129	9 mm	10	5604612034702
VIC1210	10 mm	10	5604612034719
VIC1211	11 mm	10	5604612034726
VIC1212	12 mm	10	5604612034733
VIC1213	13 mm	10	5604612034740
VIC1214	14 mm	10	5604612034757
VIC1215	15 mm	10	5604612034764
VIC1216	16 mm	10	5604612034771
VIC1217	17 mm	10	5604612034795
VIC1218	18 mm	10	5604612034788
VIC1219	19 mm	10	5604612034801
VIC1220	20 mm	10	5604612034818
VIC1221	21 mm	10	5604612034825
VIC1222	22 mm	10	5604612034832
VIC1223	23 mm	10	5604612035143
VIC1224	24 mm	10	5604612034849
VIC1226	26 mm	10	5604612034856
VIC1227	27 mm	10	5604612035136
VIC1228	28 mm	10	5604612034863
VIC1230	30 mm	10	5604612034870
VIC1232	32 mm	10	5604612034887

Chave de tubo › Box spanner

Llave de tubo › Clé tubulaire

CrV
Chrome
Vanadium



Ref.	Dim.		Ean
VICT67	6 x 7 mm	10	5604612034610
VICT89	8 x 9 mm	10	5604612034627
VICT1011	10 x 11 mm	10	5604612034634
VICT1213	12 x 13 mm	10	5604612034641
VICT1415	14 x 15 mm	5	5604612034658
VICT1617	16 x 17 mm	5	5604612034665
VICT1819	18 x 19 mm	5	5604612034672
VICT2022	20 x 22 mm	5	5604612034689
VICT2123	21 x 23 mm	5	5604612107239
VICT2426	24 x 26 mm	5	5604612107246
VICT2427	24 x 27 mm	5	5604612107253
VICT2528	25 x 28 mm	4	5604612107260
VICT2729	27 x 29 mm	4	5604612107277
VICT3032	30 x 32 mm	4	5604612107284
VICT3034	30 x 34 mm	2	5604612107291
VICT3236	32 x 36 mm	2	5604612107307
VICT3436	34 x 36 mm	2	5604612107314

Chave cardan articulada

Llave cardan articulada

Joint socket

Douille articulée à cardan

CrV
Chrome
Vanadium

1/2"



Ref.		Ean
VIC12	10	5604612034955

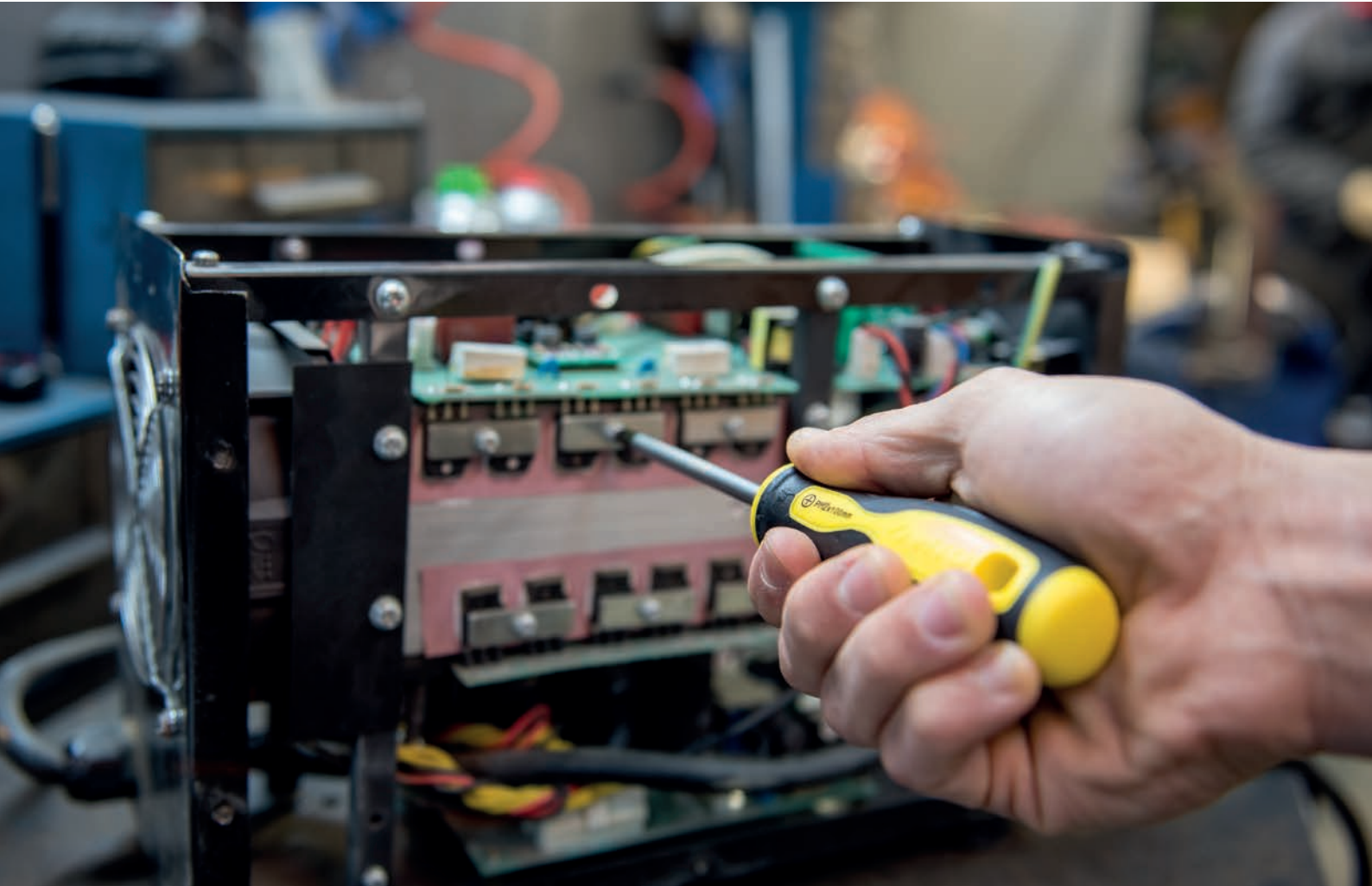

Conjunto misto de 6 chaves Pro
 Juego mixto de 6 destornilladores Pro
Set of 6 screwdrivers Pro
 Jeu de 6 tournevis mixtes Pro



CrV
 Chrome Vanadium



› Bi-material
 › 3 x 75 mm · 5 x 100 mm · PH1 x 75 mm · PH2 x 100 mm · PZ1 x 80 mm · PZ2 x 100 mm

Ref.	Ean
VICCPB6	5604612658205

Chave torx Pro › Llave torx Pro
 Torx screwdriver Pro › Tournevis torx Pro



› Bi-material

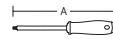

Ref.	Dim.	Ean
VICTPB10	T 10 x 100 mm	5604612658120
VICTPB15	T 15 x 100 mm	5604612658137
VICTPB20	T 20 x 125 mm	5604612658144
VICTPB25	T 25 x 125 mm	5604612658151
VICTPB30	T 30 x 125 mm	5604612658168

Chave fenda Pro › Slotted screwdriver Pro
 Destornillador boca plana Pro › Tournevis lame plate Pro



› Bi-material

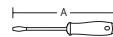

Ref.	Dim.	Ean
VICFPB375	3 x 75 mm	5604612657963
VICFPB5100	5 x 100 mm	5604612657970
VICFPB65125	6,5 x 125 mm	5604612657987
VICFPB65150	6,5 x 150 mm	5604612657994
VICFPB8150	8 x 150 mm	5604612658007
VICFPB8200	8 x 200 mm	5604612658014

Chave fenda ponta plana Pro › Destornillador boca plana Pro
Slotted parallel screwdriver Pro › Tournevis à tête plate Pro



› Bi-material

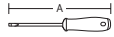

Ref.	Dim.		Ean
VICFPPB375	3 x 75 mm	12	5604612657932
VICFPPB5100	5 x 100 mm	12	5604612657949
VICFPPB65125	6,5 x 125 mm	12	5604612657956

Chave phillips Pro › Phillips screwdriver Pro
Destornillador phillips Pro › Tournevis phillips Pro



› Bi-material

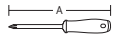

Ref.	Dim.		Ean
VICPHPB0	PH 0 x 60 mm	12	5604612658052
VICPHPB1	PH 1 x 75 mm	12	5604612658069
VICPHPB2	PH 2 x 100 mm	12	5604612658076
VICPHPB3	PH 3 x 150 mm	12	5604612658083

Chave para bits › Bit screwdriver

Destornillador para puntas › Tournevis porte embouts



› Bi-material



Ref.		Ean
VIBICB14	12	5604612658229

Chave pozidriv Pro › Pozidriv screwdriver Pro
Llave pozidriv Pro › Tournevis pozidriv Pro



› Bi-material

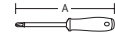

Ref.	Dim.		Ean
VICPZPB0	PZ 0 x 60 mm	12	5604612658175
VICPZPB1	PZ 1 x 80 mm	12	5604612658182
VICPZPB2	PZ 2 x 100 mm	12	5604612658199

Chave combinada fenda/phillips Pro
Destornillador boca plana/phillips Pro
Combined slotted/phillips screwdriver Pro
Tournevis combiné lame plate/phillips Pro



› Bi-material



Ref.	Dim.		Ean
VICCFPB	6 x 100 mm · PH2 X 100 mm	12	5604612658236

Chave meia lua para carburador › Screwdriver for carburetor
Llave para carburador › Clé pour carburateur



› Bi-material



Ref.		Ean
VICPC	6	5604612677596



Chave fenda isolada VDE › VDE electrician slotted screwdriver
Destornillador boca plana aislado VDE › Tournevis lame plate isolée VDE



› Bi-material

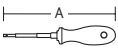

Ref.	Dim.		Ean
VICFIVDE375	3,0 x 75 mm	6	5604612654238
VICFIVDE4100	4,0 x 100 mm	6	5604612654245
VICFIVDE65150	6,5 x 150 mm	6	5604612654252

Chave phillips isolada VDE › VDE electrician phillips screwdriver
Destornillador phillips aislado VDE › Tournevis phillips isolée VDE



› Bi-material

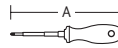

Ref.	Dim.		Ean
VICPHIVDE180	PH 1 x 80 mm	6	5604612654269
VICPHIVDE2100	PH 2 x 100 mm	6	5604612654276
VICPHIVDE3150	PH 3 x 150 mm	6	5604612654283

Chave fenda isolada Pro › Electrician slotted screwdriver Pro
Destornillador boca plana aislada Pro › Tournevis lame plate isolée Pro



› Bi-material

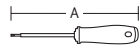

Ref.	Dim.		Ean
VICFIPB3100	3 x 100 mm	12	5604612658021
VICFIPB5125	5 x 125 mm	12	5604612658038
VICFIPB65150	6,5 x 150 mm	12	5604612658045

Chave phillips isolada Pro › Electrician phillips screwdriver Pro
Destornillador phillips aislada Pro › Tournevis phillips isolée Pro



› Bi-material

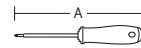

Ref.	Dim.		Ean
VICPHIPB0	PH 0 x 75 mm	12	5604612658090
VICPHIPB1	PH 1 x 100 mm	12	5604612658106
VICPHIPB2	PH 2 x 100 mm	12	5604612658113

Conjunto misto de 4 chaves isoladas Pro
Juego mixto de 4 destornilladores aislados Pro
Set of 4 electrician screwdrivers Pro
Jeu de 4 tournevis isolées Pro



› Bi-material
› 3 x 100 mm · 5 x 125 mm · PH0 x 75 mm · PH2 x 100 mm

Ref.		Ean
VICCIIPB4	6	5604612658212

Busca-pólos pequeno › Small voltage tester

Destornillador probador pequeno › Tournevis testeur petit



› 100 V - 500 V AC

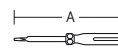

Ref.	Dim.		Ean
VIBPP	3 x 145 mm	12	5604612644123
VIBPG	4 x 192 mm	12	5604612644116

Busca-pólos pequeno Pro › Small voltage tester Pro

Destornillador probador pequeno Pro › Tournevis testeur petit Pro



› 100 V - 500 V AC

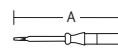

Ref.	Dim.		Ean
VIBPV	3 x 145 mm	12	5604612644147
VIBPGV	4 x 192 mm	12	5604612644130



Chave inglesa Pro › Llave inglesa Pro
Adjustable wrench Pro › Clé à molette Pro

CrV
Chrome
Vanadium

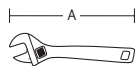

Ref.	Dim.		Ean
VICIP8	8" - 200 mm	6	5604612682361
VICIP10	10" - 250 mm	3	5604612682378
VICIP12	12" - 300 mm	3	5604612682385
VICIP15	15" - 375 mm	3	5604612682392



Chave inglesa › Llave inglesa

Adjustable wrench › Clé à molette avec graduation

CrV
Chrome
Vanadium

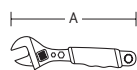

› Bi-material

Ref.	Dim.		Ean
VICIB8	8" - 200 mm	6	5604612104511
VICIB10	10" - 250 mm	3	5604612111328
VICIB12	12" - 300 mm	3	5604612111335

Chave tipo sueco › Bent nose pipe wrench

Llave ajustable para tubos › Clé suédoise réglable

Forged

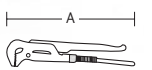

Ref.	Dim.		Ean
VICTS1	1" - 25 mm	36	5604612109684
VICTS1,5	1,5" - 32,5 mm	24	5604612109691
VICTS2	2" - 50 mm	12	5604612109707

Chave bico de papagaio › Pipe wrench german type

Llave para tubos modelo Germany › Clé à molette modèle allemand

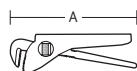

Ref.	Dim.		Ean
VIABP225	9" - 225 mm	48	5604612109714
VIABP265	10-1/2" - 265 mm	24	5604612016289
VIABP300	12" - 300 mm	10	5604612016296

Chave stillson tipo ridgid › Stillson pipe wrench ridgid type

Llave stillson tipo ridgid › Clé à griffes type ridgid

CrV
Chrome
Vanadium

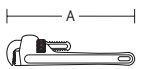

Ref.	Dim.		Ean
VICHST8	8" - 200 mm	48	5604612109622
VICHST10	10" - 250 mm	36	5604612109639
VICHST12	12" - 300 mm	24	5604612109646
VICHST14	14" - 350 mm	24	5604612109653
VICHST18	18" - 450 mm	12	5604612109660
VICHST24	24" - 600 mm	8	5604612109677



Chave dupla luneta ajustável › 2-way adjustable wrench

Llave doble estrella ajustable › Llave doble estrella clé polygonale double réglable



Carbon Steel

14in1

5 - 11 mm
11 - 19 mm



Ref.	Ean
VICDL519	6 5604612677008

23in1

5 - 15 mm
15 - 27 mm



Ref.	Ean
VICDL527	6 5604612677015

Conjunto de 8 chaves combinadas com roquete

Juego de 8 llaves combinadas de carraca

Set of 8 pcs combination spanner gear wrench

Jeu de 8 clés mixtes à cliquet



CrV
Chrome Vanadium
72 T



8 · 10 · 11 · 12 · 13 · 14 · 17 · 19 mm

Ref.	Ean
VIJCCR8	5 5604612672973

Conjunto de 12 chaves combinadas com roquete

Juego de 12 llaves combinadas de carraca

Set of 12 pcs combination spanner gear wrench

Jeu de 12 clés mixtes à cliquet



CrV
Chrome Vanadium
72 T



6 · 7 · 8 · 9 · 10 · 11 · 12 · 13 · 14 · 17 · 19 · 22 mm

Ref.	Ean
VIJCCR12	5 5604612672980

Chave combinada com roquete

Llave combinada de carraca

Combination spanner gear wrench

Clé mixte à cliquet



Ref.	Dim.	📦	Ean
VICCR6	6 mm	6	5604612672850
VICCR7	7 mm	6	5604612672867
VICCR8	8 mm	6	5604612672874
VICCR9	9 mm	6	5604612672881
VICCR10	10 mm	6	5604612672898
VICCR11	11 mm	6	5604612672904
VICCR12	12 mm	6	5604612672911
VICCR13	13 mm	6	5604612672928
VICCR14	14 mm	6	5604612672935
VICCR15	15 mm	6	5604612679330
VICCR16	16 mm	6	5604612679347
VICCR17	17 mm	6	5604612672942
VICCR18	18 mm	6	5604612679354
VICCR19	19 mm	6	5604612672959
VICCR20	20 mm	6	5604612679521
VICCR21	21 mm	6	5604612679361
VICCR22	22 mm	6	5604612672966

Chave boca/luneta

Llave combinadas fija/estrella

Combination spanner

Clé mixte



Ref.	Dim.	📦	Ean
VICBL6	6 mm	12	5604612015909
VICBL7	7 mm	12	5604612015916
VICBL8	8 mm	12	5604612015923
VICBL9	9 mm	12	5604612015930
VICBL10	10 mm	12	5604612015947
VICBL11	11 mm	12	5604612015954
VICBL12	12 mm	12	5604612015961
VICBL13	13 mm	12	5604612015978
VICBL14	14 mm	12	5604612015985
VICBL15	15 mm	12	5604612015992
VICBL16	16 mm	12	5604612016005
VICBL17	17 mm	12	5604612016012
VICBL18	18 mm	6	5604612016029
VICBL19	19 mm	6	5604612016036
VICBL20	20 mm	6	5604612016043
VICBL21	21 mm	6	5604612016050
VICBL22	22 mm	6	5604612016067
VICBL23	23 mm	6	5604612094690
VICBL24	24 mm	6	5604612016081

Chave luneta › Ring spanner

Llave estrella › Clé à polygonale



Ref.	Dim.	📦	Ean
VICL67	6 x 7 mm	12	5604612015763
VICL89	8 x 9 mm	12	5604612015770
VICL1011	10 x 11 mm	12	5604612015787
VICL1213	12 x 13 mm	12	5604612015794
VICL1415	14 x 15 mm	12	5604612015800
VICL1617	16 x 17 mm	12	5604612015817
VICL1819	18 x 19 mm	6	5604612015824
VICL2022	20 x 22 mm	6	5604612015831
VICL2123	21 x 23 mm	6	5604612015848
VICL2528	25 x 28 mm	6	5604612015862
VICL3032	30 x 32 mm	6	5604612015879

Chave bocas › Double open end spanner

Llave fija › Clé plate



Ref.	Dim.	📦	Ean
VICB67	6 x 7 mm	12	5604612015626
VICB89	8 x 9 mm	12	5604612015633
VICB1011	10 x 11 mm	12	5604612015640
VICB1213	12 x 13 mm	12	5604612015657
VICB1415	14 x 15 mm	12	5604612015664
VICB1617	16 x 17 mm	12	5604612015671
VICB1819	18 x 19 mm	6	5604612015688
VICB2022	20 x 22 mm	6	5604612015695
VICB2123	21 x 23 mm	6	5604612015701
VICB2427	24 x 27 mm	6	5604612015718
VICB2528	25 x 28 mm	6	5604612015725
VICB3032	30 x 32 mm	6	5604612015732

Conjunto de 6 chaves bocas

Juego de 6 llaves fijas

Set of 6 double open end spanners

Jeu de 6 clés plates



6 x 7 · 8 x 9 · 10 x 11 · 12 x 13 · 14 x 15 · 16 x 17 mm

Ref.	📦	Ean
VIJCB6	40	5604612015749

Conjunto 6 chaves luneta

Juego 6 llaves estrella

Set of 6 ring spanners

Jeu de 6 clés polygonales



6 x 7 · 8 x 9 · 10 x 11 · 12 x 13 · 14 x 15 · 16 x 17 mm

Ref.	📦	Ean
VIJCL6	30	5604612015886

Conjunto de 6 chaves boca/luneta

Juego de 6 llaves combinadas fija/estrella

Set of 6 combination spanner

Jeu de 6 clés mixtes



8 · 10 · 12 · 13 · 14 · 17 mm

Ref.	📦	Ean
VIJCLB6	40	5604612016098

Conjunto de 8 chaves bocas

Juego de 8 llaves fijas

Set of 8 double open end spanners

Jeu de 8 clés plates



CrV
Chrome
Vanadium

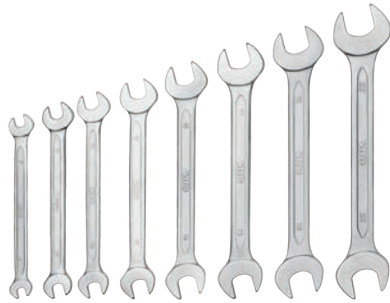

6 x 7 · 8 x 9 · 10 x 11 · 12 x 13 · 14 x 15 · 16 x 17 · 18 x 19 · 20 x 22 mm

Ref.		Ean
VIJCB8	20	5604612015756

Conjunto 8 chaves luneta

Juego 8 llaves estrella

Set of 8 ring spanners

Jeu de 8 clés polygonales



CrV
Chrome
Vanadium



6 x 7 · 8 x 9 · 10 x 11 · 12 x 13 · 14 x 15 · 16 x 17 · 18 x 19 · 20 x 22 mm

Ref.		Ean
VIJCL8	12	5604612015893

Conjunto de 8 chaves boca/luneta

Juego de 8 llaves combinadas fija/estrella

Set of 8 combination spanners

Jeu de 8 clés mixtes



CrV
Chrome
Vanadium



8 · 9 · 10 · 11 · 13 · 14 · 17 · 19mm

Ref.		Ean
VIJCBL8	12	5604612016104

Conjunto de 12 chaves bocas

Juego de 12 llaves fijas

Set of 12 double open end spanners

Jeu de 12 clés plates



CrV
Chrome
Vanadium

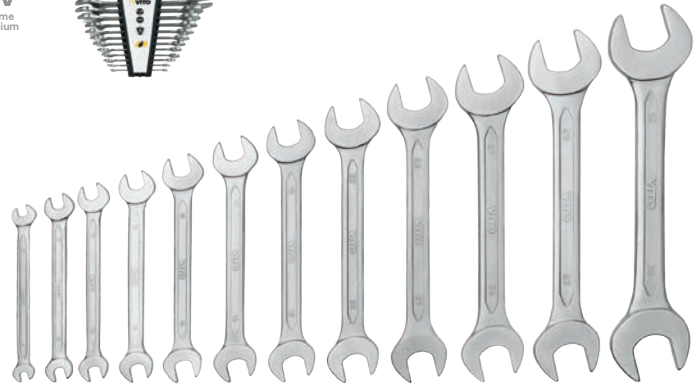

6 x 7 · 8 x 9 · 10 x 11 · 12 x 13 · 14 x 15 · 16 x 17 · 18 x 19 · 20 x 22 · 21 x 23 · 24 x 27 · 25 x 28 · 30 x 32 mm

Ref.		Ean
VIJCB12	8	5604612086169

Conjunto 12 chaves luneta

Juego 12 llaves estrella

Set of 12 ring spanners

Jeu de 12 clés polygonales



CrV
Chrome
Vanadium

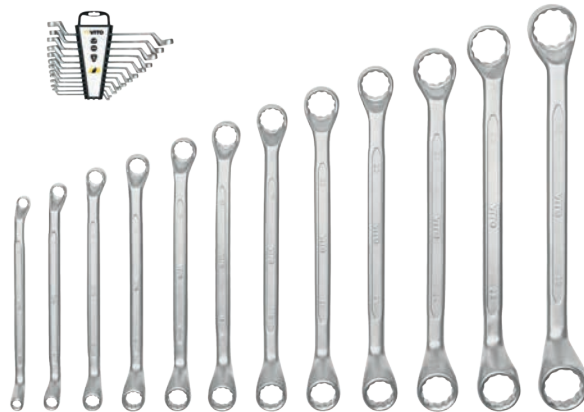

6 x 7 · 8 x 9 · 10 x 11 · 12 x 13 · 14 x 15 · 16 x 17 · 18 x 19 · 20 x 22 · 21 x 23 · 24 x 27 · 25 x 28 · 30 x 32 mm

Ref.		Ean
VIJCL12	12	5604612089092

Conjunto de 12 chaves boca/luneta

Juego de 12 llaves combinadas fija/estrella

Set of 12 combination spanners

Jeu de 12 clés mixtes



CrV
Chrome
Vanadium

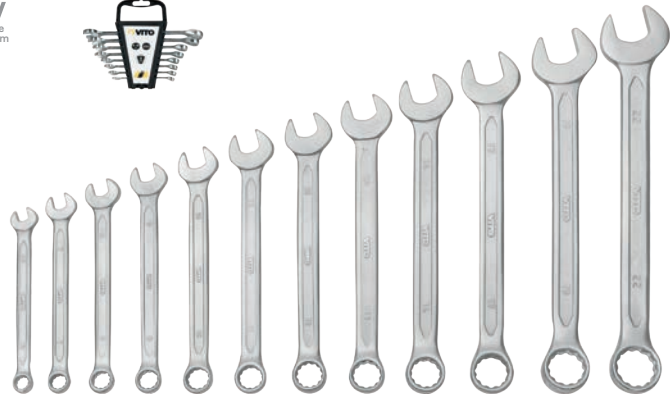

6 · 7 · 8 · 9 · 10 · 11 · 12 · 13 · 14 · 17 · 19 · 22 mm

Ref.		Ean
VIJCBL12	12	5604612021160

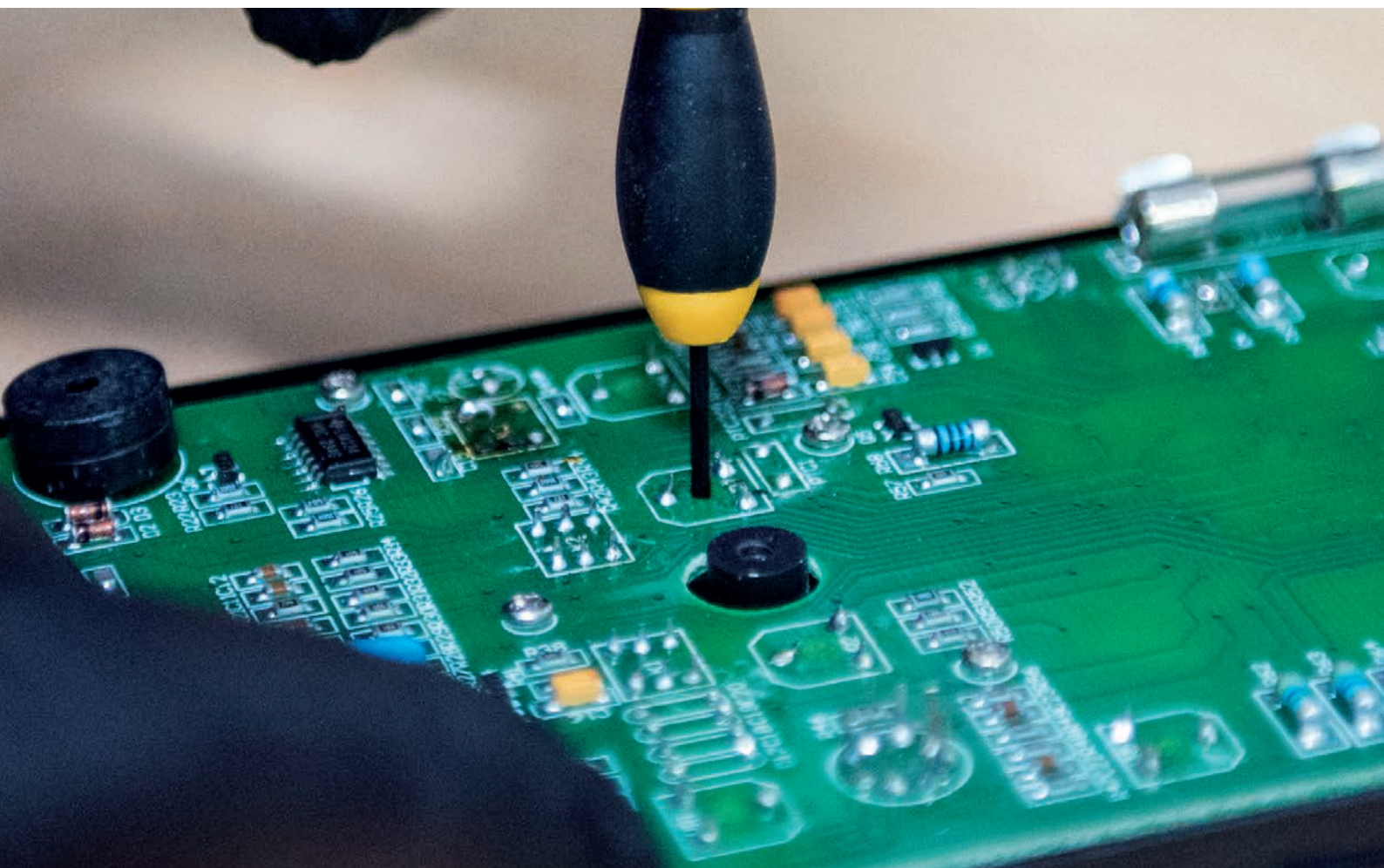

Conjunto de 6 chaves precisão
 Juego de 6 destornilladores de precisión
Set of 6 precision screwdrivers
 Jeu de 6 tournevis de précision



Conjunto de 8 chaves multiusos
 Juego de 8 llaves multiusos
Set of 8 multipurpose keys
 Jeu de 8 tournevis multifonctions



› 1,4 mm · 2 mm · 2,4 mm · 4 mm · PH0 · PH1

Ref.	Ean
VICP6	6 5604612020644



› 3 mm · 5 mm · 6 mm · PH0 · PH1 · PH2

Ref.	Ean
VICC8P	10 5604612105273



Conjunto de 33 bits
 Juego de 33 puntas
Set of 33 bits
 Jeu de 33 embouts



Ref.	Ean
VIB33	5604612649845

Conjunto 32 bits › Set of 32 bits
 Juego de 32 puntas › Jeu de 32 embouts



Ref.	Ean
VIB32	5604612666033

Conjunto 19 bits › Set of 19 bits
 Juego de 19 puntas › Jeu de 19 embouts



Ref.	Ean
VIB19	5604612666040

Conjunto de 10 bits philips › Set of 10 bits philips

Juego de 10 puntas philips › Jeu de 10 embouts philips



Ref.	Dim.	Qtd	Ean
VIBPH0	PH 0 x 25 mm	10	5604612629267
VIBPH1	PH 1 x 25 mm	10	5604612629274
VIBPH2	PH 2 x 25 mm	10	5604612629281
VIBPH3	PH 3 x 25 mm	10	5604612629298

Conjunto de 10 bits fenda › Set of 10 bit - Slot

Juego de 10 puntas boca plana › Jeu de 10 embouts Plat



Ref.	Dim.	Qtd	Ean
VIBFE3	3 x 25 mm	10	5604612629236
VIBFE5	5 x 25 mm	10	5604612629243
VIBFE6	6 x 25 mm	10	5604612629250

Adaptador para bits › Bit adapter

Adaptador para puntas › Adaptateur pour embouts



Ref.	Dim.	Qtd	Ean
VIBIA	6 x 65 mm	12	5604612026110

Conjunto de 10 bits torx inviolável › Set of 10 tamper torx

Juego de 10 puntas torx inviolable › Jeu de 10 embouts torx



Ref.	Dim.	Qtd	Ean
VIBTI15	T 15 x 25 mm	10	5604612629335
VIBTI20	T 20 x 25 mm	10	5604612629342
VIBTI25	T 25 x 25 mm	10	5604612629359
VIBTI30	T 30 x 25 mm	10	5604612629366
VIBTI40	T 40 x 25 mm	10	5604612629373

Conjunto de 10 bits pozidriv › Set of 10 pcs bit pozidriv

Juego de 10 puntas pozidriv › Jeu 10 embouts pozidriv



Ref.	Dim.	Qtd	Ean
VIBPZ1	PZ 1 x 25 mm	10	5604612629304
VIBPZ2	PZ 2 x 25 mm	10	5604612629311
VIBPZ3	PZ 3 x 25 mm	10	5604612629328

Adaptador magnético › Magnet nut driver

Adaptador magnetico › Adaptateur magnétique



Ref.	Dim.	Qtd	Ean
VIAM6	6 x 65 mm	50	5604612629380
VIAM8	8 x 65 mm	50	5604612629397
VIAM10	10 x 65 mm	50	5604612629403
VIAM12	12 x 65 mm	50	5604612650193



Chave torx com segredo em "L"

Tamper star key

Llave torx con secreto en "L"

Tournevis torx avec trou



Ref.	Dim.	📦	Ean
VICTS10	T 10	10	5604612038489
VICTS15	T 15	10	5604612038496
VICTS20	T 20	10	5604612038502
VICTS25	T 25	10	5604612038519
VICTS30	T 30	10	5604612038526
VICTS40	T 40	10	5604612038533

Chave hexagonal em "L"

Llaves allen en "L"

Hex key

Clé mâle



Ref.	Dim.	📦	Ean
VICHS15	1,5 mm	10	5604612038359
VICHS2	2 mm	10	5604612038366
VICHS25	2,5 mm	10	5604612038373
VICHS3	3 mm	10	5604612038380
VICHS4	4 mm	10	5604612038397
VICHS5	5 mm	10	5604612038403
VICHS6	6 mm	10	5604612038410
VICHS7	7 mm	10	5604612038427
VICHS8	8 mm	10	5604612038434
VICHS9	9 mm	10	5604612038441
VICHS10	10 mm	10	5604612038458
VICHS12	12 mm	10	5604612038465
VICHS14	14 mm	10	5604612038472

Chave hexagonal com pega

Llave allen con mango

T handle

Clé mâle hexagonale manche en T



Ref.	Dim.	📦	Ean
VICHSB2	2 mm	10	5604612038205
VICHSB25	2,5 mm	10	5604612038212
VICHSB3	3 mm	10	5604612038229
VICHSB4	4 mm	10	5604612038236
VICHSB5	5 mm	10	5604612038243
VICHSB6	6 mm	10	5604612038250
VICHSB8	8 mm	10	5604612038267
VICHSB10	10 mm	10	5604612038274
VICHSB12	12 mm	10	5604612038281

Conjunto de 7 chaves torx com segredo em canivete

Juego de 7 llaves torx con secreto en navaja

Set of 7 folding tamper star hex keys

Jeu de 7 clés torx avec trou



› T10 · T15 · T20 · T25 · T27 · T30 · T40

Ref.	📦	Ean
VIJCTSCP7	12	5604612086527

Conjunto de 7 chaves hexagonais em canivete

Juego de 7 llaves allen en navaja

Set of 7 folding hex keys

Jeu de 7 clés mâle



› 1,5 · 2 · 2,5 · 3 · 4 · 5 · 6 mm

Ref.	📦	Ean
VIJCHCP7	12	5604612086497

Cj. de 9 chaves torx com segredo

Juego de 9 llaves torx con secreto

Set of 9 tamper star keys

Jeu de 9 clés torx avec trou



› T10 · T15 · T20 · T25 · T27 · T30 · T40 · T45 · T50

Ref.	Ean
VIJCTSP9	5604612086442

Cj. de 9 chaves hexagonais

Juego de 9 llaves allen

Set of 9 hex keys

Jeu de 9 clés mâles



› 1,5 · 2 · 2,5 · 3 · 4 · 5 · 6 · 8 · 10 mm

Ref.	Ean
VIJCHP9	5604612086411

Cj. de 9 chaves hexagonais tipo bola

Juego de 9 llaves allen serie larga modelo bola

Set of 9 ball point hex keys

Jeu de 9 clés mâles tête sphérique



› 1,5 · 2 · 2,5 · 3 · 4 · 5 · 6 · 8 · 10 mm

Ref.	Ean
VIJCHBP9	5604612086428

Cj. de 9 chaves torx longas com segredo

Juego de 9 llaves torx larga con secreto

Set of 9 long tamper star keys

Jeu de 9 clés torx avec trou longues



› T10 · T15 · T20 · T25 · T27 · T30 · T40 · T45 · T50

Ref.	Ean
VIJCTSLP9	5604612086480

Cj. de 9 chaves hexagonais longas

Juego de 9 llaves allen serie larga

Set of 9 long hex keys

Jeu de 9 clés mâles longues



› 1,5 · 2 · 2,5 · 3 · 4 · 5 · 6 mm

Ref.	Ean
VIJCHLP9	5604612086459

Cj. 9 chaves hexagonais longas tipo bola

Juego 9 llaves allen serie larga modelo bola

Set of 9 long ball point hex key

Jeu de 9 clés mâles longues tête sphérique



› T10 · T15 · T20 · T25 · T27 · T30 · T40 · T45 · T50

Ref.	Ean
VIJCHBLP9	5604612086466

Conjunto de 8 chaves torx com segredo em canivete

Juego de 8 llaves torx con secreto en navaja

Set of 8 torx wrench folding tamper

Jeu de 8 clés torx avec trou type canif



1,5 · 2 · 2,5 · 3 · 4 · 5 · 6 · 8 mm

Ref.	Ean
VIJCTI8	5604612023690

Conjunto de 10 chaves hexagonais em canivete

Juego de 10 llaves hexagonales en navaja

Set of 10 folding hexagonal key

Jeu de 10 clés mâles



› 1,5 · 2 · 2,5 · 3 · 4 · 5 · 5,5 · 6 · 8 · 9 mm

Ref.	Ean
VIJCH10	5604612023683



Alicate universal
 Alicates universal
Combination plier
 Pince universelle

CrV
 Chrome
 Vanadium

› Bi-material

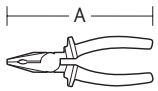

Ref.	A	📦	Ean
VIAU150	150 mm	6	5604612016364
VIAU175	175 mm	6	5604612016371
VIAU200	200 mm	6	5604612016388

Alicate pontas direitas › Long nose plier
 Alicates boca semiredonda recta › Pince bec droit

CrV
 Chrome
 Vanadium

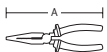

Ref.	A	📦	Ean
VIAPO150	150 mm	6	5604612019778
VIAPO200	200 mm	6	5604612016340

Alicate pontas chatas › Flat nose plier
 Alicates boca plana › Pince bec plat

CrV
 Chrome
 Vanadium



Ref.	A	📦	Ean
VIAPC150	150 mm	6	5604612016401

Alicate pontas curvas › Long nose bent plier

Alicate boca semiredonda acodada › Pince bec coudé

CrV
Chrome
Vanadium

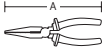

Ref.	A		Ean
VIAPOC150	150 mm	6	5604612019792
VIAPOC200	200 mm	6	5604612019808

Alicate pontas redondas › Round nose plier

Alicate boca redonda › Pince bec rond

CrV
Chrome
Vanadium

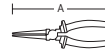

Ref.	A		Ean
VIAPR150	150 mm	6	5604612016357

Alicate corte lateral › Side cutting plier

Alicate corte diagonal › Pince coupante de côté

CrV
Chrome
Vanadium

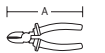

Ref.	A		Ean
VIACO150	150 mm	6	5604612016302
VIACO175	175 mm	6	5604612019761

Alicate de freios 4 cabeças › Snap ring plier set 4 heads

Alicate de puntas 4 cabezas › Pince circlips avec 4 têtes

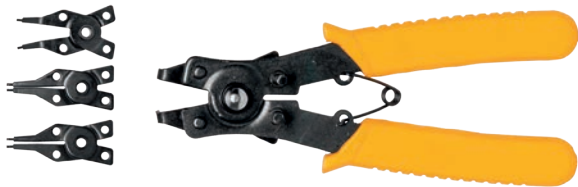

8 funções › 8 functions › 8 funciones › 8 fonctions

Ref.	A		Ean
VIAF4	150-170 mm	6	5604612628437

Conjunto de 3 alicates › Set of 3 pliers

Juego de 3 alicates › Jeu de 3 pinces



CrV
Chrome
Vanadium



Ref.			Ean
VICM3		5	5604612111298

Alicate descarnar fio › Wire snip plier

Alicate pelacables › Pince à dénuder manuelle

CrV
Chrome
Vanadium



Ref.	A		Ean
VIADF6	150 mm	6	5604612016319

Alicate vasador › Punch plier

Alicate sacabocados › Pince emporte pièce

CrV
Chrome
Vanadium

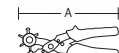

Ref.	A		Ean
VIAV	225 mm	6	5604612019822



Alicate universal isolado VDE › VDE combination plier
Alicate universal aislado VDE › Pince universelle isolée VDE



Ref.	A	📦	Ean
VIAUI160	160 mm	6	5604612105198
VIAUI180	180 mm	6	5604612105204

Alicate corte lateral isolado VDE › Alicate corte diagonal aislado VDE
VDE side cutting plier › Pince coupante de côté isolée VDE



Ref.	A	📦	Ean
VIACO160	160 mm	6	5604612105235

Alicate descarnar fio isolado VDE › VDE wire snip plier
Alicate pelacables aislado VDE › Pince à dénuder manuelle isolée VDE

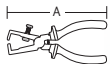

Ref.	A	📦	Ean
VIADI160	160 mm	6	5604612105228



Conjunto de 3 alicates aislados VDE

Juego de 3 alicates aislados VDE
Set of 3 VDE pliers
Jeu de 3 pinces isolées VDE



Ref.	📦	Ean
VICMAE	2	5604612111311

Alicate pontas direitas isolado VDE › VDE long nose plier

Alicate boca semiredonda recta aislado VDE › Pince bec droit isolée VDE

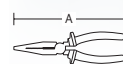

Ref.	A	📦	Ean
VIAPOI200	200 mm	6	5604612105259

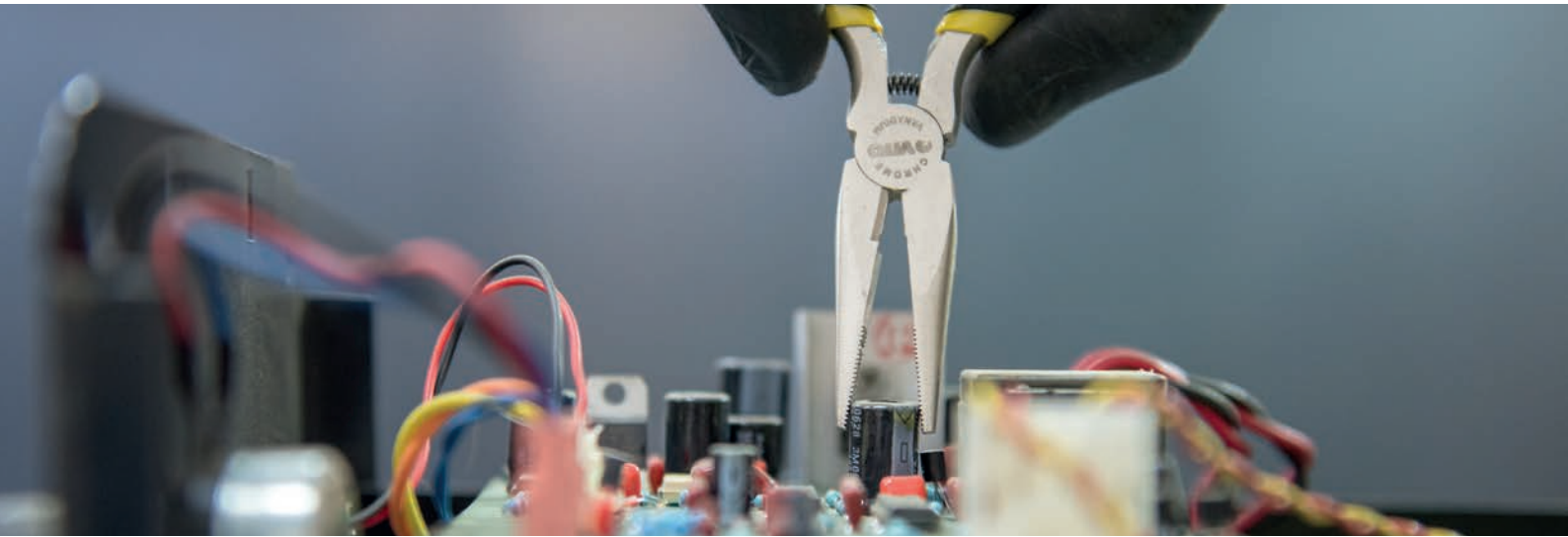

Alicate eletrónica universal

Alicate electrónica universal

Combination plier electronics

Pince universelle pour l'électronique



CrV
Chrome
Vanadium



Ref.	A	Ean
VIAUE130	130 mm	6 5604612023492

Alicate eletrónica pontas direitas

Alicate electrónica de boca recta

Long nose plier for electronics

Pince bec droit pour l'électronique

CrV
Chrome
Vanadium



Ref.	A	Ean
VIAPE120	130 mm	6 5604612035129

Alicate de freios internos ponta curva

Alicate interior punta curva

Internal clip plier

Pince à bec courbé circlips intérieur

CrV
Chrome
Vanadium



Ref.	A	Ean
VIAFI150	150 mm	6 5604612016333

Alicate de freios externos ponta curva

Alicate exterior punta curva

External clip plier

Pince à bec courbé circlips extérieur

CrV
Chrome
Vanadium



Ref.	A	Ean
VIAFE150	150 mm	6 5604612016326

Alicate eletrónica corte frontal

Alicate electrónica corte frontal

Front cutting plier electronics

Pince coupante de devant pour l'électronique

CrV
Chrome
Vanadium



Ref.	A	Ean
VIACFE130	130 mm	6 5604612023478

Alicate eletrónica corte lateral

Alicate electrónica corte diagonal

Side cutting plier electronics

Pince coupante de côté pour l'électronique

CrV
Chrome
Vanadium



Ref.	A	Ean
VIACLE130	130 mm	6 5604612023485

Conjunto de 5 alicates eletrónica

Juego de 5 alicates de electrónica

Set of 5 pliers for electronics

Jeu de 5 pinces pour l'électronique



CrV
Chrome
Vanadium



Ref.	Ean
VIAE5	3 5604612019938

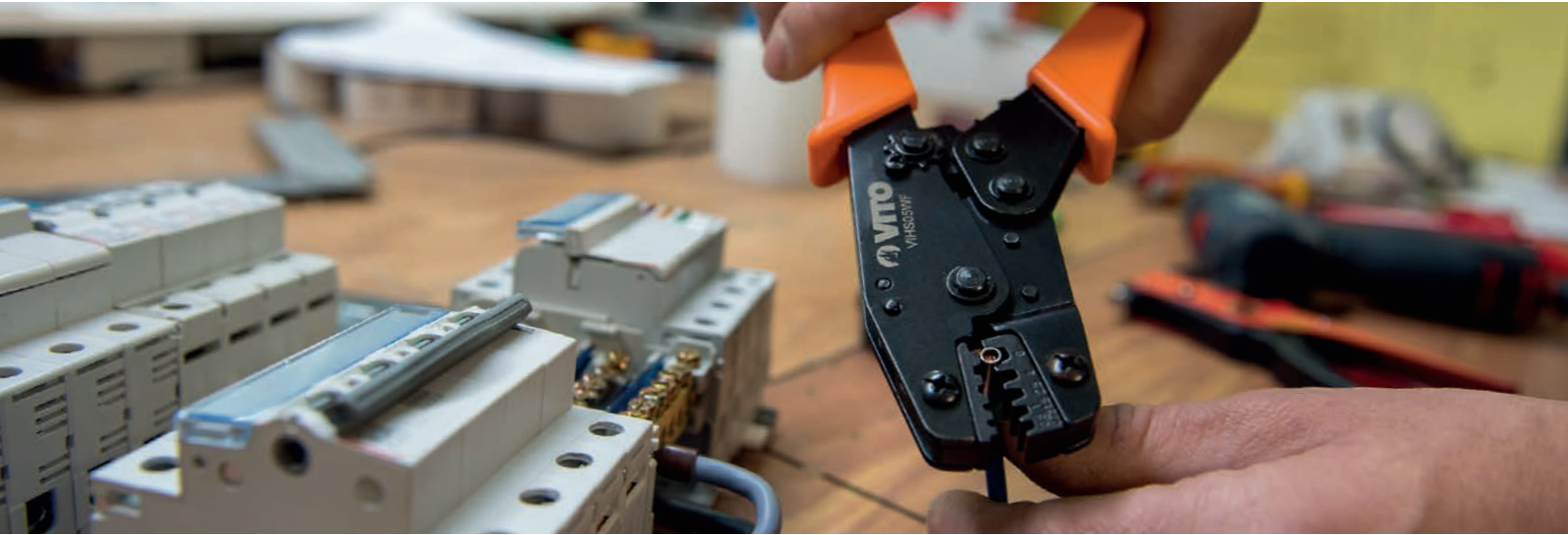

Alicate de cravar ponteiras › Alicate de cravar punteras
Terminal embedder plier › Pince à sertir pour embouts



Ref.	A	Ean
VIHS40WF	230 mm	5604612643775

Alicate de cravar ponteiras › Terminal embedder plier
Alicate de cravar punteras › Pince à sertir pour embouts



Ref.	A	Ean
VIHS05WF	203 mm	5604612643751

Alicate de cravar ficha rita › Plug embedding plier
Alicate de cravar clavija rita › Pince à sertir pour connecteurs
RJ11 - 4/6 P
RJ45 - 8 P



Ref.	A	Ean
VIHT200R	205 mm	5604612643768

Alicate de cravar terminais › Terminal embedder plier
Alicate de cravar terminales › Pince à sertir pour terminaux



Ref.	A	Ean
VIHS30JJ	230 mm	5604612643782

Alicate de descarnar e de cravar terminais
Alicate pelacables y de cravar terminales
Wire stripper and crimper
Pince à dénuder et à sertir les terminaux



Ref.	A	Ean
VIADC	180 mm	5604612664305

Alicate cravar terminais › Alicate cravar terminales
Plug embedding plier › Pince à sertir pour terminaux



Ref.	A	Ean
VIHS0650	390 mm	5604612643799
VIHS16120	620 mm	5604612649227



Alicate pressão Pro › Pressure plier Pro
 Alicate del apretón Pro › Pince étau Pro

CrV
 Chrome
 Vanadium

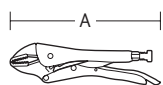

Ref.	A	📦	Ean
VIAPP7	175 mm	6	5604612682347
VIAPP10	250 mm	6	5604612682354

Alicate bomba de água plus › Water pump plier plus
 Alicate pico de loro plus › Pince multiprise plus

CrV
 Chrome
 Vanadium

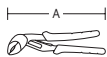

Ref.	A	📦	Ean
VIABAP250	250 mm	6	5604612678937

Alicate bomba de água › Water pump plier
 Alicate pico de loro › Pince multiprise

CrV
 Chrome
 Vanadium

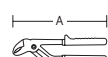

Ref.	A	📦	Ean
VIABA250	250 mm	6	5604612016272



Alicate de rebitar
Remachadora
Professional riveting plier
Pince à riveter



3/32" - 2,4mm
1/8" - 3,2mm
5/32" - 4,0mm
3/16" - 4,8mm

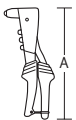

Ref.	Dim.	Ean
VIARP	6	5604612023355

Alicate de rebitar
Remachadora
Riveting plier
Pince à riveter



3/32" - 2,4mm
1/8" - 3,2mm
5/32" - 4,0mm
3/16" - 4,8mm

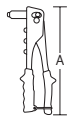

Ref.	Dim.	Ean
VIAREB	6	5604612019815

Alicate corta rebites
Alicate corta remaches
Bolt clipper
Pince coupe rivet



CrV
Chrome
Vanadium

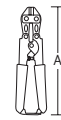

Ref.	Dim.	Ean
VICR8	6	5604612025670

Conjunto de rebites de alumínio
Juego de remaches de aluminio
Aluminium rivet set
Jeu de rivets en aluminium



Ref.	Dim.	Pack	Dim.	Ean
VIR38B	3 x 8 mm	20 un.	12	5604612633295
VIR310B	3 x 10 mm	20 un.	12	5604612633288
VIR412B	4 x 12 mm	15 un.	12	5604612633301
VIR414B	4 x 14 mm	15 un.	12	5604612633318
VIR510B	5 x 10 mm	15 un.	12	5604612633325
VIR512B	5 x 12 mm	15 un.	12	5604612633332

Conjunto de 500 rebites de alumínio
Juego de 500 remaches de aluminio
Set of 500 aluminium rivets
Jeu de 500 rivets aluminium



Ref.	Dim.	Dim.	Ean
VIR36	3 x 6 mm	5	5604612023836
VIR38	3 x 8 mm	5	5604612023843
VIR310	3 x 10 mm	5	5604612023850
VIR312	3 x 12 mm	5	5604612023867
VIR314	3 x 14 mm	5	5604612023874
VIR316	3 x 16 mm	5	5604612023881

Ref.	Dim.	Dim.	Ean
VIR46	4 x 6 mm	5	5604612023898
VIR48	4 x 8 mm	5	5604612023904
VIR410	4 x 10 mm	5	5604612023911
VIR412	4 x 12 mm	5	5604612023928
VIR414	4 x 14 mm	5	5604612023935
VIR416	4 x 16 mm	5	5604612023942
VIR418	4 x 18 mm	5	5604612023959
VIR420	4 x 20 mm	5	5604612023966
VIR56	5 x 6 mm	5	5604612023973
VIR58	5 x 8 mm	5	5604612023980
VIR510	5 x 10 mm	5	5604612023997
VIR512	5 x 12 mm	5	5604612024000
VIR514	5 x 14 mm	5	5604612024017
VIR516	5 x 16 mm	5	5604612024024
VIR518	5 x 18 mm	5	5604612024031
VIR520	5 x 20 mm	5	5604612024048
VIR525	5 x 25 mm	5	5604612024055
VIR530	5 x 30 mm	5	5604612024062
VIR535	5 x 35 mm	5	5604612652715



Agrafador/pregador
 Grapadora/clavador
Staple/nail gun
 Agrafeuse/loueuse manuelle



Ref. VIAP14
 Ean 5604612172329

Agrafador
 Grapadora
Staple gun
 Agrafeuse manuelle



Ref. VIA610
 Ean 5604612113520

Conjunto de 1000 pregos com cabeça
 Juego de 1000 clavos con cabeza
Set of 1000 nails
 Jeu de 1000 clous



Ref. VIAP814
 Dim. 14 mm
 N° 3
 Ean 5604612172336

Conjunto de 1000 pregos sem cabeça
 Juego de 1000 clavos sin cabeza
Set of 1000 headless nails
 Jeu de 1000 clous sans tête



Ref. VIAP914
 Dim. 14 mm
 N° 9
 Ean 5604612172343

Conjunto de 1000 agrafos
 Juego de 1000 grapas
Set of 1000 staples
 Jeu de 1000 agrafe



Ref.	Dim.	N°	Ean
VIA36	6 mm	9	5604612113537
VIA38	8 mm	9	5604612113544
VIA310	10 mm	9	5604612113551
VIA312	12 mm	9	5604612113568



Corta varão › Bolt cutter

Corta varillas › Coupe boulons

CrV
Chrome
Vanadium

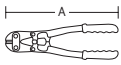

Ref.	A		Ean
VICVP14	14" - 350 mm	20	5604612688011
VICVP18	18" - 450 mm	10	5604612688028
VICVP24	24" - 600 mm	10	5604612688035
VICVP30	30" - 750 mm	5	5604612688042
VICVP36	36" - 900 mm	5	5604612688059

Turquês › Pincer

Tenaza › Tenaille

CrV
Chrome
Vanadium

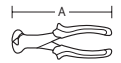

Ref.	A		Ean
VITCB180	180 mm	6	5604612649814

Turquês de carpinteiro › Carpenter pincer

Tenaza carpintero › Tenaille de menuisier

CrV
Chrome
Vanadium



Ref.	A		Ean
VITC180	180 mm	6	5604612016418

Alicate para cortar cabo de aço › Steel cable cutter

Alicate para cortar cable de acero › Pince coupe cable en acier

CrV
Chrome
Vanadium

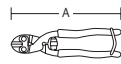

Ref.	A		Ean
VIACC200	200 mm	6	5604612676261

Turquês de arameiro › Tower pincer

Tenaza rusa › Tenaille russe

CrV
Chrome
Vanadium

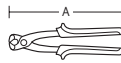

Ref.	A		Ean
VITA220	220 mm	6	5604612016395

Turquês de arameiro › Tower pincer

Tenaza rusa › Tenaille russe

CrV
Chrome
Vanadium

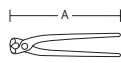

Ref.	A		Ean
VITA225	225 mm	6	5604612649647
VITA250	250 mm	6	5604612649654



Tesoura para cortar chapa › Aviation tinman's snips
Tijera para cortar chapa › Cisaille à tôle



Ref.	A		Ean
VITC8	8" - 200 mm	6	5604612142773
VITC10	10" - 250 mm	6	5604612005207
VITC12	12" - 300 mm	6	5604612142780



Tesoura direita para cortar chapa › Right aviation tinman's snips
Tijera derecha para corta chapa › Pince coupe-tôle droite

CrV
Chrome
Vanadium

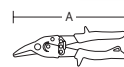

Ref.	A		Ean
VITCCDI	10" - 250 mm	6	5604612667542



Tesoura esquerda para cortar chapa › Left aviation tinman's snips
Tijera izquierda para corta chapa › Pince coupe-tôle gauche

CrV
Chrome
Vanadium

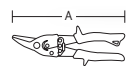

Ref.	A		Ean
VITCCES	10" - 250 mm	6	5604612667535



Tesoura recta para cortar chapa › Straight aviation tinman's snips
Tijera reta corta chapa › Pince coupe-tôle devant

CrV
Chrome
Vanadium

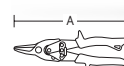

Ref.	A		Ean
VITCCRE	10" - 250 mm	6	5604612667528





Serrote corte ferro › Hacksaw frame

Sierra corte hierro › Scie à métaux

HSS
Bi-metal



Ref.	Dim.	Tpi	📦	Ean
VISCFEB	12" - 300 mm	24	6	5604612629854

Serrote corte ferro tubular ajustável › Tubular adjustable hacksaw frame

Sierra corte hierro tubular ajustable › Scie à métaux tubulaire réglable

HSS
Bi-metal



Ref.	Dim.	Tpi	📦	Ean
VISCFET	12" - 300 mm	24	6	5604612668808

Serrote corte ferro ajustável › Adjustable hacksaw frame

Sierra corte hierro ajustable › Scie à métaux réglable

Carbon
Steel



Ref.	Dim.	Tpi	📦	Ean
VISCFE	12" - 300 mm	24	6	5604612103040

Mini serrote corte de ferro › Mini hacksaw

Mini sierra corte hierro › Mini scie à métaux

Carbon
Steel



Ref.	Dim.	Tpi	📦	Ean
VIMSF	12" - 300 mm	24	6	5604612171438

Conjunto de 3 folhas de serra corte ferro em HSS

Juego de 3 hojas de sierra corte hierro en HSS

Set of 3 high speed steel hacksaw HSS blade

Jeu de 3 Lames en acier rapide pour scie à métaux HSS

HSS



Ref.	Dim.	Tpi		Ean
VIFCFHK3B	12" - 300 mm	24	12	5604612641900

Conjunto de 100 folhas de serra corte ferro em HSS

Juego de 100 hojas de sierra corte hierro en HSS

Set of 100 high speed steel hacksaw HSS blade

Jeu de 100 lames en acier rapide pour scie à métaux HSS

HSS



Ref.	Dim.	Tpi		Ean
VIFCFHK	12" - 300 mm	24	5	5604612641894

Conjunto de 3 folhas de serra corte ferro em HSS

Juego de 3 hojas de sierra corte hierro en HSS

Set of 3 high speed steel hacksaw blade

Jeu de 3 Lames en acier rapide pour scie à métaux HSS

Carbon Steel



Ref.	Dim.	Tpi		Ean
VIFCFMK3B	12" - 300 mm	24	12	5604612641887

Conjunto de 100 folhas de serra corte ferro em HSS

Juego de 100 hojas de sierra corte hierro en HSS

Set of 100 high speed steel hacksaw blade

Jeu de 100 lames en acier rapide pour scie à métaux HSS

Carbon Steel



Ref.	Dim.	Tpi		Ean
VIFCFMK	12" - 300 mm	24	5	5604612641870

Conjunto de 3 folhas serra corte ferro em HSS bimetálico flexível

Juego de 3 hojas de sierra corte hierro en HSS bimetálico flexible

Set of 3 bimetal flexible hacksaw HSS blade

Jeu de 3 lames bimetal pour scie à métaux souple HSS

HSS Bi-metal



Ref.	Dim.	Tpi		Ean
VIFCFBK3B	12" - 300 mm	24	12	5604612641924

Conjunto de 100 folhas serra corte ferro em HSS bimetálico flexível

Juego de 100 hojas de sierra corte hierro en HSS bimetálico flexible

Set of 100 bimetal flexible hacksaw HSS blade

Jeu de 100 lames bimetal pour scie à métaux souple HSS

HSS Bi-metal



Ref.	Dim.	Tpi		Ean
VIFCFBK	12" - 300 mm	24	5	5604612641917

Conjunto de 3 folhas de serra corte ferro em cobalto

Juego de 3 hojas de sierra corte hierro en acero al cobalto

Set of 3 cobalt hacksaw blade

Jeu de 3 Lames pour scie à métaux en cobalt

Carbon Steel



Ref.	Dim.	Tpi		Ean
VIFCFCK3B	12" - 300 mm	24	12	5604612680671

Conjunto de 100 folhas de serra corte ferro cobalto

Juego de 100 hojas de sierra corte hierro cobalto

Set of 100 cobalt hacksaw

Jeu de 100 lames pour scie en acier cobalt

Carbon Steel



Ref.	Dim.	Tpi		Ean
VIFCFCK	12" - 300 mm	24	5	5604612680664

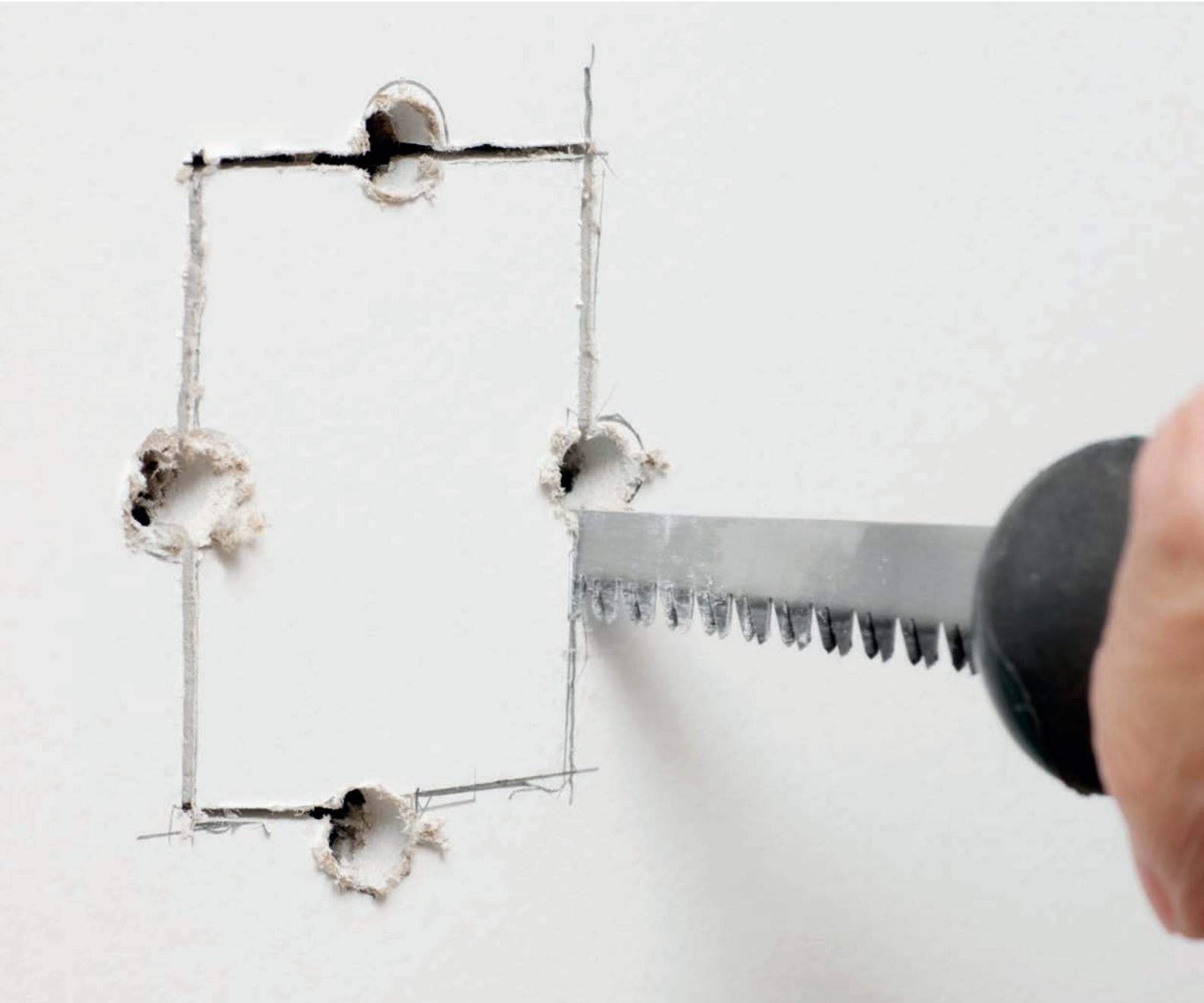

Serrote para painéis de gesso › Plaster hacksaw

Serrucho para paneles de yeso › Scie pour plâtre

SK5
Carbon
Steel

Triple
bevel

› Lâmina em aço carbono SK5 › SK5 carbon steel blade
› Cuchilla en acero al carbono SK5 › Lame en acier carbone SK5

Ref.	Dim.	Tpi	Ean
VISG500	20" - 300 mm	7	5604612650643



Serrote para painéis de gesso › Plaster hacksaw

Serrucho para paneles de yeso › Scie pour plâtre

SK5
Carbon
Steel

Triple
bevel

Ref.	Dim.	Tpi	Ean
VISPG	6" - 150 mm	7	5604612637156



Serrote multiusos › Multipurpose hacksaw

Sierra multiusos › Scie multi-usages

Carbon Steel



Ref.	Dim.	Tpi		Ean
VISM	12" - 300 mm	18 - 24	12	5604612023294

Folha para serrote multiusos › Saw blade

Hoja para sierra multiusos › Lames pour scie multi-usages

Carbon Steel



Ref.	Dim.	Tpi		Ean
VIFSM305	12" - 300 mm	18	10	5604612156756

Serra para trabalhos manuais › Hand work hacksaw frame

Sierra para trabajos manuales › Scie à araser réversible

SAE1070
Carbon Steel



Ref.	Dim.	Tpi		Ean
VIST8120	20" - 500 mm	9	6	5604612012847

Serra para trabalhos manuais › Hand work hacksaw frame

Sierra para trabajos manuales › Scie à araser réversible

Carbon Steel



Ref.	Dim.	Tpi		Ean
VISTM	6" - 150 mm	24	6	5604612668815

Conjunto de 5 folhas de serra para serrote trabalhos manuais

Juego de 5 hojas para sierra trabajos manuales

Set of 5 blades for hand work hacksaw frame

Jeu de 5 lames pour scie à araser réversible

Carbon Steel



Ref.	Dim.	Tpi		Ean
VIFSTM5	6" - 150 mm	24	1	5604612678944

Folha para serrote de talho › Blade for butcher saw

Hoja para sierra de tajo › Lame pour scie de boucher

SAE1070
Carbon Steel



Ref.	Dim.	Tpi		Ean
VIFST	20" - 500 mm	9	6	5604612013561



Serrrote de costas profissional › Professional hacksaw

Serrucho de costilla profesional › Scie à onglet professionnelle

SAE1070

Carbon
Steel

- › Permite afiação dos dentes › It allows grinding of teeth.
- › Permite afiladura de los dentes › Il permet des grincements de dents.

Ref.	Dim.	Tpi		Ean
VISC11012	12" - 300 mm	11	6	5604612099695
VISC11014	14" - 350 mm	11	6	5604612643553



Serrrote profissional para carpinteiro › Professional hacksaw

Serrucho profesional para carpintero › Scie à égoïne professionnelle

SAE1070

Carbon
Steel

- › Permite afiação dos dentes › It allows grinding of teeth.
- › Permite afiladura de los dentes › Il permet des grincements de dents.

Ref.	Dim.	Tpi		Ean
VISC10218	18" - 450 mm	6	6	5604612643560
VISC10220	20" - 500 mm	6	6	5604612643577
VISC10222	22" - 550 mm	6	6	5604612643584
VISC10224	24" - 600 mm	6	6	5604612643591



Serrote carpinteiro › Hacksaw

Serrucho carpinteiro › Scie égoïne



Lâmina em aço carbono SK5 › SK5 carbon steel blade
Cuchilla en acero al carbono SK5 › Lame en acier carbone SK5

Ref.	Dim.	Tpi		Ean
VISCP450	18" - 450 mm	7	6	5604612662400
VISCP500	20" - 500 mm	7	6	5604612662417
VISCP550	22" - 550 mm	7	6	5604612662424

Serrote carpinteiro › Hacksaw

Serrucho carpinteiro › Scie égoïne



Lâmina em aço carbono SK5 › SK5 carbon steel blade
Cuchilla en acero al carbono SK5 › Lame en acier carbone SK5

Ref.	Dim.	Tpi		Ean
VISCB450	18" - 450 mm	7	10	5604612666057
VISCB500	20" - 500 mm	7	10	5604612666064
VISCB550	22" - 550 mm	7	10	5604612666071

Serrote de costas › Back saw

Serrucho de costila › Scie à dos



Lâmina em aço carbono SK5 › SK5 carbon steel blade
Cuchilla en acero al carbono SK5 › Lame en acier carbone SK5

Ref.	Dim.	Tpi		Ean
VISCCP300	12" - 300 mm	11	6	5604612662431
VISCCP350	14" - 350 mm	11	6	5604612662448

Serrote de costas › Back saw

Serrucho de costila › Scie à dos



Lâmina em aço carbono SK5 › SK5 carbon steel blade
Cuchilla en acero al carbono SK5 › Lame en acier carbone SK5

Ref.	Dim.	Tpi		Ean
VISCB300	12" - 300 mm	11	10	5604612666088
VISCB350	14" - 350 mm	11	10	5604612666095

Serrote de ponta › Handsaw

Serrucho de punta › Scie guichet



› Lâmina em aço carbono SK5
› SK5 carbon steel blade
› Cuchilla en acero al carbono SK5
› Lame en acier carbone SK5

Ref.	Dim.	Tpi		Ean
VISPCP300	12" - 300 mm	8	6	5604612662455

Serrote de ponta › Handsaw

Serrucho de punta › Scie guichet



› Lâmina em aço carbono SK5
› SK5 carbon steel blade
› Cuchilla en acero al carbono SK5
› Lame en acier carbone SK5

Ref.	Dim.	Tpi		Ean
VISPB300	12" - 300 mm	11	10	5604612666101

Caixa de esquadria com serrote costas › Miter box with back saw

Guia de ingletar con serrucho de costilla › Boîte à onglet avec scie à dos



Ref.	Dim.	Tpi		Ean
VICE350	14" - 350 mm	11	12	5604612103033

Caixa de esquadria › Miter box

Guia de ingletar › Boîte à onglet



Ref.	Dim.	Tpi		Ean
VICE12	12" - 300 mm		24	5604612103026



Cortador metálico › Metal retractable utility knife
Cutter metálico › Cutter métallique



Ref.	Blade	QTY	Ean
VIXM9	9 mm - VILX9	24	5604612110840



Cortador com lâminas › Utility knife with blades
Cutter con cuchillas › Cutter avec lames

5 x



Ref.	Blade	QTY	Ean
VIX9	9 mm - VILX9	12	5604612019600



Cortador com lâminas › Utility knife with blades
Cutter con cuchillas › Cutter avec lames

5 x



Ref.	Blade	QTY	Ean
VIX18	18 mm - VILX18	12	5604612019594



Cortador com lâminas › Utility knife with blades
Cutter con cuchillas › Cutter avec lames

3 x



Ref.	Blade	QTY	Ean
VIX25	25 mm - VILX25	6	5604612665067



Expositor de cortadores - 36 un.

Retractable knife exhibitor - 36 un.

Expositor de cutters - 36 un.

Présentoir de cutters - 36 un.

12 x

24 x



Ref.	Blade	QTY	Ean
VIEX936	9 mm - VIXM9 18 mm - VILX18	1	5604612110833

Expositor de cortadores - 24 un.

Expositor de cutters - 24 un.

Utility knife exhibitor - 24 un.

Présentoir de cutters - 24 un.

12 x



Ref.	Blade	QTY	Ean
VIEX1824	18 mm - VILX18	1	5604612110826

Conjunto de cortadores com lâminas › Knife set with blades

Juego cutters con cuchillas › Jeu cutters avec lames

10 x  10 x 



Ref.			Ean
VIX918	9 mm - VILX9 18 mm - VILX18	12	5604612682750

Faca de alcatifa com lâminas

Cutter de alfombra con cuchillas
Professional carpe knife with blade
 Cutter spécial moquette avec lames



Ref.			Ean
VIFAP	18 mm - VILFA	6	5604612019617

Faca de alcatifa com canivete dobrável

Cutter con cuchillo pegable
Foldable carpet and multipurpose knife
 Cutter avec couteau pliant spécial moquette



Ref.			Ean
VIFAC	18 mm - VILFA	6	5604612640095

Corta vidro › Oil glass cutter

Cutter de vidro › Coupe-verre



› Cortante em tungsténio › Tungsten cutting
 › Cortante en tungsteno › Coupe en tungstène

Ref.		Ean
VICVP	6	5604612113261

Faca de precisão › Precision utility knife

Cutter de precisión › Cutter de précision



Ref.			Ean
VIXP	VILXP	18	5604612110857

Faca de alcatifa

Cutter de alfombra
Carpet knife
 Cutter spécial moquette



Ref.			Ean
VIFA	18 mm - VILFA	12	5604612023300

Faca de alcatifa dobrável

Cutter plegable
Foldable carpet knife
 Cutter avec couteau pliant spécial moquette



Ref.			Ean
VIFAB	18 mm - VILFA	6	5604612640088

Cortador de vidro › Glass cutter

Cutter de vidro › Coupe-verre



› Cortante em tungsténio › Tungsten cutting
 › Cortante en tungsteno › Coupe en tungstène

Ref.		Ean
VICV6	6	5604612113254

Cj. de 10 lâminas para cortador
 Juego de 10 cuchillas rectas para cutter
Set of 10 blades for utility knife
 Jeu de 10 lames pour cutter



Ref.			Ean
VILX9	9 mm	25	5604612023331
VILX18	18 mm	12	5604612023348
VILX25	25 mm	12	5604612665074



Cj. de 10 lâminas para faca de precisão
 Juego de 10 cuchillas rectas para cutter de precisión
Set of 10 blades for precision knife
 Jeu de 10 lames pour cutter de précision



Ref.		Ean
VILXP	12	5604612110864

Cj. de 5 lâminas para faca de alcatifa
 Juego de 5 cuchillas para cutter de alfombra
Set of 5 blades for carpet knife
 Jeu de 5 lames pour cutter spécial moquette



Ref.			Ean
VILFA	18 mm	24	5604612019662

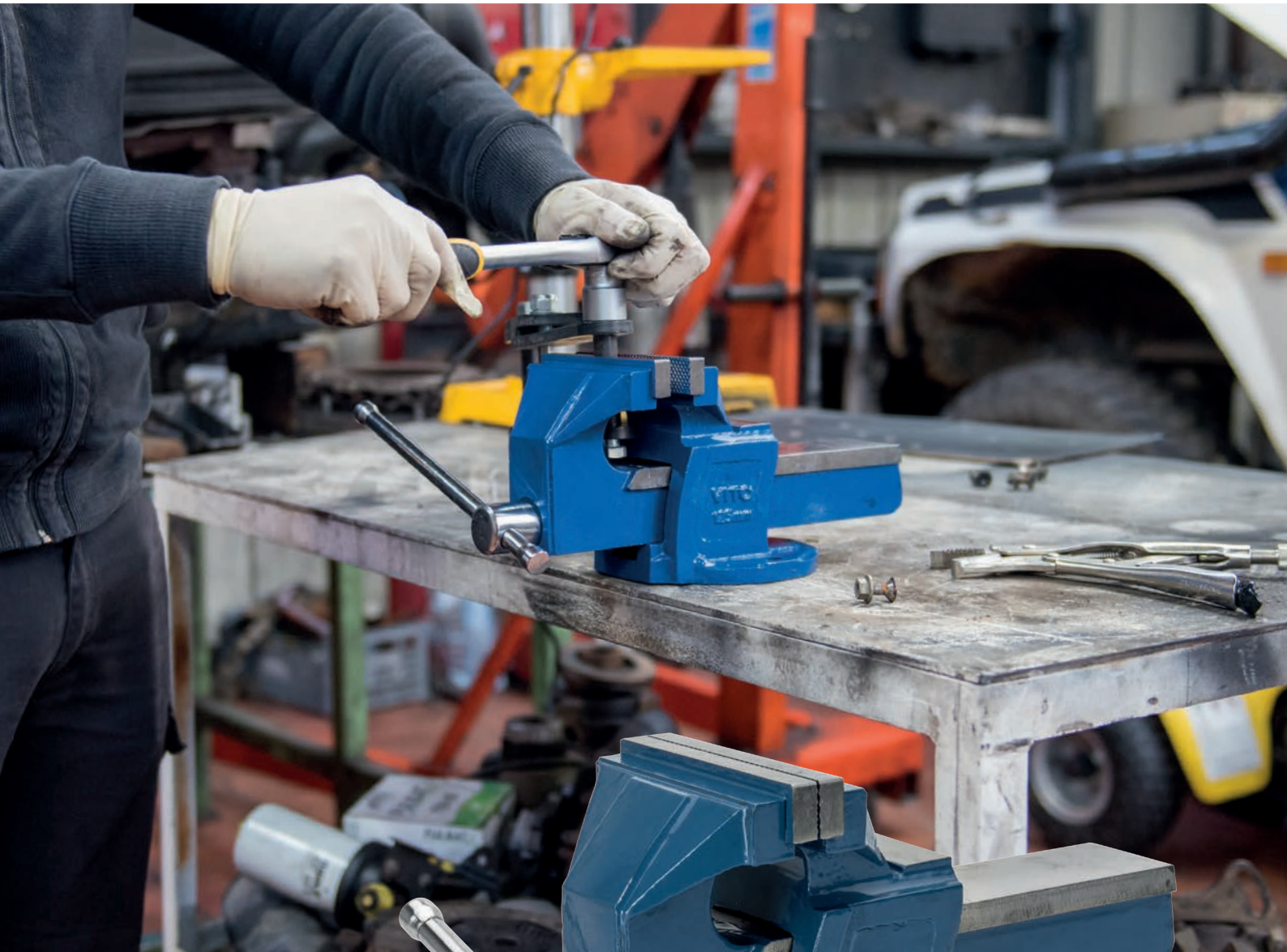

Torno de bancada

Tornillo de banco

Bench vice

Étau en fonte



Ref.	Dim.	kg	📦	Ean
VITB100	100 mm	4,6 kg	4	5604612628819
VITB125	125 mm	9 kg	2	5604612628826
VITB150	150 mm	12 kg	1	5604612628833

Base giratória para torno de bancada

Base giratória para tornillo de banco

Swivel base for bench vice

Base tournante pour étau



Ref.	📦	Ean
VITB100B	1	5604612632601
VITB125B	1	5604612632595
VITB150B	1	5604612632618

Punho para torno de bancada

Mango para tornillo de banco

Handle for bench vice

Poignée pour étau



Ref.	📦	Ean
VITB100P	26	5604612632656
VITB125P	26	5604612632663
VITB150P	26	5604612632670

Mordentes para torno bancada

Mordaza para tornillo de banco

Jaws for bench vice

Mors pour étau



Ref.	📦	Ean
VITB100M	1	5604612632625
VITB125M	1	5604612632632
VITB150M	1	5604612632649



Grampo de aperto rápido plus › Quick clamp plus
Tornillo de apriete rápido plus › Serre-joint rapide plus

Ref.	Dim.		Ean
VIGAR80150	80 x 150 mm	6	5604612669447
VIGAR80200	80 x 200 mm	6	5604612669454
VIGAR80300	80 x 300 mm	6	5604612669461
VIGAR80450	80 x 450 mm	6	5604612669478



Grampo de aperto rápido

Tornillo de apriete rapido

F-clamp

Serre-joints

› Bi-materia

Ref.	Dim.		Ean
VIG50150	50 x 150 mm	6	5604612625917
VIG50200	50 x 200 mm	6	5604612625924
VIG50250	50 x 250 mm	6	5604612028275
VIG80200	80 x 200 mm	6	5604612028282
VIG80300	80 x 300 mm	6	5604612625931
VIG80500	80 x 500 mm	6	5604612625948
VIG80800	80 x 800 mm	6	5604612625955
VIG120300	120 x 300 mm	6	5604612028305
VIG120500	120 x 500 mm	6	5604612625962
VIG120800	120 x 800 mm	6	5604612625979
VIG1201000	120 x 1000 mm	6	5604612625986



Conjunto 2 pinças de fixação

Juego 2 prensas de resorte

Set of 2 spring clamps

Jeu de 2 pinces de fixation



› Bi-materia

Ref.	Dim.		Ean
VIPN100	100 mm	6	5604612669485
VIPN150	150 mm	6	5604612669492



Lima redonda bastarda › Round file bastard

Lima redonda basta › Lime ronde bâtarde



› Bi-material

Ref.	Dim.		Ean
VILRB6	6" - 150 mm	10	5604612106218
VILRB8	8" - 200 mm	10	5604612106225
VILRB10	10" - 250 mm	10	5604612106232

Lima plana paralela bastarda › Hand file bastard

Lima plana paralela basta › Lime plate à main bâtarde



› Bi-material

Ref.	Dim.		Ean
VILPB6	6" - 150 mm	10	5604612106331
VILPB8	8" - 200 mm	10	5604612106348
VILPB10	10" - 250 mm	10	5604612106355

Lima chata bastarda › Flat file bastard

Lima plana basta › Lime plate bâtarde



› Bi-material

Ref.	Dim.		Ean
VILCB6	6" - 150 mm	10	5604612106270
VILCB8	8" - 200 mm	10	5604612107109
VILCB10	10" - 250 mm	10	5604612106294

Lima quadrada bastarda › Square file bastard

Lima quadrada basta › Lime carrée bâtarde



› Bi-material

Ref.	Dim.		Ean
VILQB6	6" - 150 mm	10	5604612106157
VILQB8	8" - 200 mm	10	5604612106164
VILQB10	10" - 250 mm	10	5604612106171

Lima redonda murça › Round file smooth

Lima redonda fina › Lime ronde mi-douce



› Bi-material

Ref.	Dim.		Ean
VILRM6	6" - 150 mm	10	5604612106188
VILRM8	8" - 200 mm	10	5604612106195
VILRM10	10" - 250 mm	10	5604612106201

Lima plana paralela murça › Hand file smooth

Lima plana paralela fina › Lime plate à main mi-douce



› Bi-material

Ref.	Dim.		Ean
VILPM6	6" - 150 mm	10	5604612106300
VILPM8	8" - 200 mm	10	5604612106317
VILPM10	10" - 250 mm	10	5604612106324

Lima chata murça › Flat file smooth

Lima plana fina › Lime plate mi-douce



› Bi-material

Ref.	Dim.		Ean
VILCM6	6" - 150 mm	10	5604612106249
VILCM8	8" - 200 mm	10	5604612106256
VILCM10	10" - 250 mm	10	5604612106263

Lima quadrada murça › Square file smooth

Lima quadrada fina › Lime carrée mi-douce



› Bi-material

Ref.	Dim.		Ean
VILQM6	6" - 150 mm	10	5604612106126
VILQM8	8" - 200 mm	10	5604612106133
VILQM10	10" - 250 mm	10	5604612106140

Lima meia cana bastarda › Half round file bastard

Lima media cana basta › Lime demi-ronde bâtarde



› Bi-material

Ref.	Dim.	📦	Ean
VILMCB6	6" - 150 mm	10	5604612106393
VILMCB8	8" - 200 mm	10	5604612106409
VILMCB10	10" - 250 mm	10	5604612106416

Lima triangular regular › Three square file second cut

Lima triangular entrefina › Lime triangulaire régulière



› Bi-material

Ref.	Dim.	📦	Ean
VILTR3	3" - 75 mm	10	5604612106041
VILTR4	4" - 100 mm	10	5604612106058
VILTR5	5" - 125 mm	10	5604612106065
VILTR6	6" - 150 mm	10	5604612106072
VILTR7	7" - 175 mm	10	5604612106089

Lima para motosserra › Chain saw file

Lima para motosierra › Lime tronçonneuse



› Bi-material

Ref.	Dim.	📦	Ean
VILM532	5/32" - 3,96 mm	10	5604612106461
VILM316	3/16" - 4,76 mm	10	5604612106454
VILM732	7/32" - 5,56 mm	10	5604612106478
VILM14	1/4" - 6,35 mm	10	5604612106485

Lima meia cana murça › Half round file smooth

Lima media cana fina › Lime demi-ronde mi-douce



› Bi-material

Ref.	Dim.	📦	Ean
VILMCM6	6" - 150 mm	10	5604612106362
VILMCM8	8" - 200 mm	10	5604612106379
VILMCM10	10" - 250 mm	10	5604612106386

Lima triangular murça › Three square file smooth

Lima triangular fina › Lime triangulaire mi-douce



› Bi-material

Ref.	Dim.	📦	Ean
VILTM3	3" - 75 mm	10	5604612106096
VILTM4	4" - 100 mm	10	5604612106102
VILTM5	5" - 125 mm	10	5604612106119

Conjunto de 4 limas para motosserra › Set of 4 pieces chain saw file

Juego de 4 limas para motosierra › Jeu de 4 limes pour tronçonneuse



Ref.	Dim.	📦	Ean
VILM4532	5/32" - 3,96 mm	10	5604612670535
VILM4316	3/16" - 4,76 mm	10	5604612670542
VILM4732	7/32" - 5,56 mm	10	5604612670528
VILM414	1/4" - 6,35 mm	10	5604612670511

Cabo bimatéria para lima

Mango bimatéria para lima

Bi-material file handle

Manche bi-matière pour lime



› Bi-material

Ref.	Dim.	📦	Ean
VICLB3E4	3" / 4"	12	5604612106492
VICLB5	5"	12	5604612106515
VICLB6E7	6" / 7"	12	5604612114978
VICLB8	8"	12	5604612114985
VICLB10	10"	12	5604612114992

Cabo de madeira para lima

Mango de madeira para lima

Wood file handle

Manche en bois pour lime



Ref.	Nº	A x B	📦	Ean
VICLI0	0	105 x 26 mm	12	5604612006549
VICLI1	1	114 x 27 mm	12	5604612091903
VICLI2	2	121 x 30 mm	12	5604612037970
VICLI3	3	130 x 31 mm	12	5604612091910
VICLI4	4	133 x 31 mm	12	5604612037987
VICLI5	5	139 x 34 mm	12	5604612091927
VICLI6	5	144 x 35 mm	12	5604612037994

Cabo de madeira para formões e goivas

Mango de madeira para formões y gubias

Chisels and gouges wood handle

Manche en bois pour des ciseaux et gouges



Ref.	Nº	A x B	📦	Ean
VICF0	0	122 x 22 mm	12	5604612091835
VICF1	1	124 x 24 mm	12	5604612091842
VICF2	2	132 x 26 mm	12	5604612091859
VICF3	3	136 x 29 mm	12	5604612091866
VICF4	4	141 x 30 mm	12	5604612091873
VICF5	5	151 x 34 mm	12	5604612091880
VICF6	6	156 x 35 mm	12	5604612091897



Formão
Formon
Wood chisel
Ciseau à bois

CrV MAXPRO
Chrome
Vanadium



› Bi-material

Ref.	Dim.		Ean
VIFMXP6	1/4" - 6 mm	10	5604612662462
VIFMXP8	5/16" - 8 mm	10	5604612662479
VIFMXP10	3/8" - 10 mm	10	5604612662486
VIFMXP12	15/32" - 12 mm	10	5604612662493
VIFMXP14	9/16" - 14 mm	10	5604612662509
VIFMXP16	5/8" - 16 mm	10	5604612662516
VIFMXP19	3/4" - 19 mm	10	5604612662523
VIFMXP22	7/8" - 22 mm	10	5604612662530
VIFMXP25	1" - 25 mm	10	5604612662547
VIFMXP28	11/8" - 28 mm	10	5604612662554
VIFMXP30	13/16" - 30 mm	10	5604612662561
VIFMXP35	13/8" - 35 mm	10	5604612662578
VIFMXP38	11/2" - 38 mm	10	5604612662585



Raspador de madeira
Rascador de madeira
Wood scraper
Lame grattoir de bois



Ref.	Dim.		Ean
VIRM150	150 mm	50	5604612105907

Raspador madeira
Rascador madeira
Wood scraper
Grattoir de bois



Ref.	Dim.		Ean
VIRM60	60 mm	6	5604612105877

Grosa meia cana › Half round wood rasp
Escofina de media caña › Ràpe demi-ronde



› Bi-material

Ref.	Dim.		Ean
VIG6	6" - 150 mm	10	5604612106423
VIG8	8" - 200 mm	10	5604612106430
VIG10	10" - 250 mm	10	5604612106447

Grosa carpinteiro › Round wood rasp
Escofina carpinteiro › Ràpe ronde à bois



› Bi-material

Ref.	Dim.		Ean
VIGC8	8" - 200 mm	10	5604612132408
VIGC10	10" - 250 mm	10	5604612132415

**Construção
e carpintaria**
Construcción
y carpinteria
**Construction
and carpentry**
Construction
et menuiserie



**Carro de mão
roda pneumática**

Carretilla rueda
neumática

**Wheelbarrow
pneumatic wheel**

Brouette roue
pneumatique

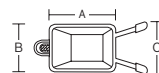

Ref.	CAP.	A x B x C		Ean
VICA1	85 L	820 X 640 X 580 mm	1	5604612002077

Carro de mão roda grande

Carretilla rueda grande

Wheelbarrow big wheel

Brouette grande roue

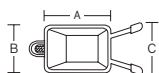

Ref.	CAP.	A x B x C		Ean
VICA2	85 L	820 x 640 x 580 mm	1	5604612023744

Carro de mão roda pneumática

Carretilla rueda neumática

Wheelbarrow pneumatic wheel

Brouette roue pneumatique

› Mod. Euro.

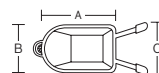

Ref.	CAP.	A x B x C		Ean
VICA4	90 L	990 x 580 x 580 mm	1	5604612019266

Carro de mão roda pneumática - Desmontado

Carretilla rueda neumática - Desmontada

Wheelbarrow pneumatic wheel - Disassembled

Brouette roue pneumatique - Démontée

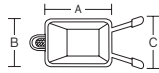

Ref.	CAP.	A x B x C	📦	Ean
VICAD12	85 L	820 x 640 x 580 mm	6	5604612019273

Carro de mão roda pneumática - Desmontado

Carretilla rueda neumática - Desmontada

Wheelbarrow pneumatic wheel - Disassembled

Brouette roue pneumatique - Démontée

› Mod. Euro.

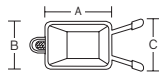

Ref.	CAP.	A x B x C	📦	Ean
VICAD13	85 L	940 x 540 x 580 mm	6	5604612019860

Roda pneumática para carro de mão

Rueda neumática para carretilla

Pneumatic wheel for wheelbarrow

Roue pneumatique pour brouette



Ref.	Ø	📦	Ean
VIRO1	350 mm	1	5604612658946

Roda maciça para carro de mão

Rueda maciza para carretilla

Solid wheel for wheelbarrow

Roue massive pour brouette



Ref.	Ø	📦	Ean
VIRO2	350 mm	1	5604612658953

Carro de mão galvanizado - Desmontado

Carretilla galvanizada - Desmontada

Galvanized wheelbarrow - Disassembled

Brouette galvanisée - Démontée

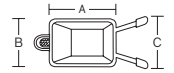

Ref.	CAP.	A x B x C	📦	Ean
VICA20	85 L	820 x 640 x 580 mm	6	5604612665272

Carro de jardim/aterro PVC

Carretilla de jardín/terraplén PVC

PVC garden and rubble wheelbarrow

Brouette de jardin en PVC

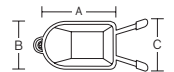

Ref.	CAP.	A x B x C	📦	Ean
VICA19	100 L	940 x 600 x 580 mm	1	5604612627065

Roda em PU para carro de mão

Rueda de PU para carretilla

PU wheel for wheelbarrow

Roue en PU pour brouette



Ref.	Ø	📦	Ean
VIROD3	350 mm	1	5604612673178

Câmara de ar para roda pneumática

Cámara de aire para rueda neumática

Handcart (air chamber)

Chambre à air



Ref.	📦	Ean
VICA15	1	5604612038663



Picadeira cabo de fibra

Pico mango fibra

Pick hammer fiberglass handle

Martelette manche fibre

- › Aço temperado › Hardened steel
- › Acero templado › Acier trempé

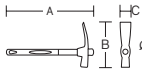

Ref.	A x B x C	⊖	⊖	/KG	⊞	Ean
VIPCF	320 x 185 x 45 mm	30 mm	VICFRP	865 g	6	5604612099749

Picadeira cabo de madeira

Pico mango madeira

Pick hammer wood handle

Martelette manche en bois

- › Aço temperado › Hardened steel
- › Acero templado › Acier trempé

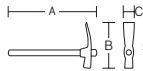

Ref.	A x B x C	⊖	⊖	/KG	⊞	Ean
VIPCM	360 x 185 x 45 mm	30 mm	VI4915E	865 g	6	5604612099756

Picadeira pá e bico cabo de fibra

Pico pala y punta mango fibra

Pic axe hammer fiberglass handle

Martelette pic et panne manche en fibre

- › Aço temperado › Hardened steel
- › Acero templado › Acier trempé



Ref.	A x B x C	⊖	⊖	/KG	⊞	Ean
VIPBPF	325 x 275 x 40 mm	30 mm	VICFRP	665 g	6	5604612099701

Picadeira pá e bico cabo de madeira

Pico pala y punta mango madeira

Pic axe hammer wood handle

Martelette pic et panne manche en bois

- › Aço temperado › Hardened steel
- › Acero templado › Acier trempé

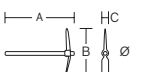

Ref.	A x B x C	⊖	⊖	/KG	⊞	Ean
VIPBPM	360 x 275 x 40 mm	30 mm	VI4915E	600 g	6	5604612099718

Picadeira pá e machado cabo de fibra

Pico pala y hacha mango fibra

Cutter mattock hammer fiberglass handle

Martelette à tête et panne manche en fibre

- › Aço temperado › Hardened steel
- › Acero templado › Acier trempé

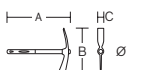

Ref.	A x B x C	⊖	⊖	/KG	⊞	Ean
VIPPMF	325 x 255 x 40 mm	30 mm	VICFRP	700 g	6	5604612099725

Picadeira pá e machado cabo de madeira

Pico pala y hacha mango madeira

Cutter mattock hammer wood handle

Martelette à tête et panne manche en bois

- › Aço temperado › Hardened steel
- › Acero templado › Acier trempé

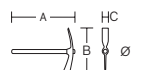

Ref.	A x B x C	⊖	⊖	/KG	⊞	Ean
VIPPM	360 x 255 x 40 mm	30 mm	VI4915E	735 g	6	5604612099732



Picareta com cabo fibra

Pico pala y punta con mango fibra

Pick axe with fiber handle

Pioche chantier avec manche fibre

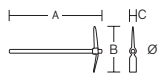

Ref.	A x B x C	⊖	⏏	KG	📦	Ean
VIPC25	570 x 61 x 48 mm	46 mm	VICP	2,5 kg	6	5604612016241

Picareta com cabo madeira

Pico pala y punta mango de madera

Pick axe with wood handle

Pioche chantier avec manche

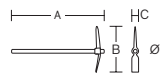

Ref.	A x B x C	⊖	⏏	KG	📦	Ean
VIPC25C	570 x 61 x 48 mm	50 mm	VI4050	2,5 kg	1	5604612639112

Alvião pá e machado com cabo

Alcotana pala y hacha con mango

Mattock (shovel/axe) with handle

Pioche hache avec manche

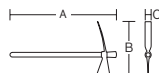

Ref.	A x B x C	⊖	⏏	KG	📦	Ean
VI3070C	465 x 70 x 43 mm	44 mm	VI4050	1,80 kg	1	5604612653453

Picareta sem cabo

Pico pala y punta sin mango

Pick axe without handle

Pioche de chantier sans manche

› Aço temperado › Hardened steel
› Acero templado › Acier trempé



Ref.	B x C	⊖	⏏	KG	📦	Ean
VIP25	570 x 61 mm	48 mm	VICP	2,5 kg	6	5604612014803

Picareta mineiro › Miner's pick axe

Pico mineiro › Pioche mineur

› Aço temperado › Hardened steel
› Acero templado › Acier trempé



Ref.	B x C	⊖	⊕	/KG	⊞	Ean
VI3220	510 x 60 mm	43 mm	VI4050	1,8 kg	6	5604612033613

Picão moinho › Windmill pick axe

Pico molino › Pioche moulin

› Aço temperado › Hardened steel
› Acero templado › Acier trempé



Ref.	B x C	⊖	⊕	/KG	⊞	Ean
VI3205	290 x 45 mm	20-30 mm	VI4061	850 g	6	5604612033637

Cabo picareta › Handle pick

Mango pico › Manche pour pioche

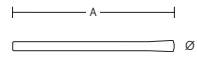

Ref.	A	⊖	/KG	⊞	Ean
VI4050	900 mm	49 mm	1,0 kg	25	5604612004583
VI4051	1200 mm	52 mm	1,3 kg	25	5604612109370
VI4052	1300 mm	48 mm	1,9 kg	25	5604612094959

Cabo fibra para picareta › Fiber glass handle steel pick

Mango fibra para pico › Manche fibre pour pioche chantier

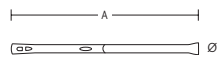

Ref.	A	⊖	/KG	⊞	Ean
VICP	900 mm	46 mm	1,1 kg	20	5604612014810

Cabo para picão moinho

Mango para picão molino

Handle for windmill pick axe

Câble pour picon moulin

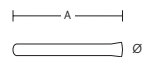

Ref.	A x B	⊖	/KG	⊞	Ean
VI4061	490 mm	20 - 26 mm	245 g	1	5604612686260

Alvião pá e machado sem cabo › Mattock-shovel/axe without handle

Alcotana pala y hacha sin mango › Pioche - hache sans manche

› Aço temperado › Hardened steel
› Acero templado › Acier trempé



Ref.	B x C	⊖	⊕	/KG	⊞	Ean
VI3070	470 x 115 mm	45 mm	VI4050	1,8 kg	6	5604612012755

Picão pedreiro › Mason pick axe

Pico cantero › Pioche à maçon

› Aço temperado › Hardened steel
› Acero templado › Acier trempé



Ref.	B x C	⊖	⊕	/KG	⊞	Ean
VI3210	340 x 57 mm	30-37 mm	VI4040	2,5 kg	6	5604612033620

Cabo marreta oval › Drilling handle

Mango maceta oval › Manche de masse oeil ovale

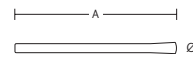

Ref.	A	⊖	/KG	⊞	Ean
VI4040	800 mm	38 mm	565 g	25	5604612006457
VI4041	1000 mm	38 mm	645 g	25	5604612102944

Cabo de fibra para picadeira › Fiber glass handle type pick

Mango de fibra para pico › Manche fibre rond pour martelette

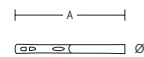

Ref.	A	⊖	/KG	⊞	Ean
VICFRP	325 mm	28 mm	150 g	10	5604612100469

Cabo de madeira envernizado para picadeira

Mango de madeira barnizada para pico

Varnished wood handle for pick hammer

Manche pour pioche bois vernis

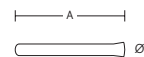

Ref.	A	⊖	/KG	⊞	Ean
VI4915E	360 mm	28 mm	155 g	1	5604612644895



Pá quadrada cabo madeira

Pala cuadrada mango madera

Square head shovel wood handle

Pelle carrée manche en bois

- › Aço temperado
- › Acero templado
- › Hardened steel
- › Acier trempé



Ref.	A x B x C	📦	Ean
VIPQCM	980 x 250 x 340 mm	6	5604612017835

Pá quadrada cabo madeira tipo "T"

Pala cuadrada mango madera tipo "T"

Square head shovel wood "T" handle

Pelle carrée manche en bois poignée en "T"

- › Aço temperado
- › Acero templado
- › Hardened steel
- › Acier trempé



Ref.	A	📦	Ean
VIPQCMT	1000 x 250 x 340 mm	6	5604612135973

Pá de bico cabo de ferro

Pala de punta mango de hierro

Point head shovel metal handle

Pelle ronde manche en fer

- › Aço temperado
- › Acero templado
- › Hardened steel
- › Acier trempé



Ref.	A x B x C	📦	Ean
VIPBCF	980 x 290 x 340 mm	6	5604612017859

Pá de bico cabo madeira

Pala de punta mango madera

Point head shovel wood handle

Pelle ronde manche en bois

- › Aço temperado
- › Acero templado
- › Hardened steel
- › Acier trempé



Ref.	A x B x C	📦	Ean
VIPBCM	980 x 290 x 340 mm	6	5604612017842

Pá bico cabo madeira tipo "T"

Pala de punta mango madera tipo "T"

Point head shovel wood "T" handle

Pelle ronde manche en bois poignée en "T"

- › Aço temperado
- › Acero templado
- › Hardened steel
- › Acier trempé



Ref.	A x B x C	📦	Ean
VIPBCM T	1000 x 290 x 340 mm	6	5604612135966

Pá de bico tipo francês cabo madeira

Pala de punta tipo francés mango madera

Point head shovel french model wood handle

Pelle ronde modèle français manche en bois

- › Aço temperado
- › Acero templado
- › Hardened steel
- › Acier trempé



Ref.	A x B x C	📦	Ean
VIPBTFM	1450 x 310 x 310 mm	6	5604612638139

Pá de alumínio cabo madeira com pega

Pala de aluminio con empuñadura mango madera

Aluminium scoop shovel with handle

Pelle aluminium manche en bois avec poignée



Ref.	A x B x C	📦	Ean
VIPAC	1010 x 290 x 360 mm	6	5604612108793

Pá de alumínio cabo madeira longo

Pala de aluminio mango madera larga

Aluminium scoop shovel with handle

Pelle aluminium long manche en bois



Ref.	A x B x C	📦	Ean
VIPA CL	1560 x 290 x 400 mm	6	5604612108809

Pá francesa

Palote frances

French type shovel

Pelle modèle français

- › Aço temperado
- › Acero templado
- › Hardened steel
- › Acier trempé



Ref.	A x B x C	📦	Ean
VIPAAG0009	1430 x 135 x 250 mm	6	5604612614393

Pá para valas cabo madeira

Palote para zanjas

Shovel for ditches wood handle

Bêche de chantier manche en bois

- › Aço temperado
- › Acero templado
- › Hardened steel
- › Acier trempé



Ref.	A x B x C	📦	Ean
VIPAAG0007	1080 x 145 x 300 mm	6	5604612613747

Pá para valas cabo ferro

Pala para zanjas mango hierro

Square shovel metal handle

Bêche de chantier manche en fer

- › Aço temperado
- › Acero templado
- › Hardened steel
- › Acier trempé



Ref.	A x B x C		Ean
VIPVCF	1020 x 190 x 300 mm	6	5604612017866

Pá de trilhos cabo madeira

Pala de trillos mango madera

Square shovel long wood handle

Bêche manche en bois

- › Aço temperado
- › Acero templado
- › Hardened steel
- › Acier trempé



Ref.	A x B x C		Ean
VIPT588	1430 x 135 x 250 mm	6	5604612017873

Rodo espanha redondo albedo com cabo

Raedera español con mango

Round spanish type scraper with handle

Grattoire espanhol rond avec manche

- › Aço temperado
- › Acero templado
- › Hardened steel
- › Acier trempé

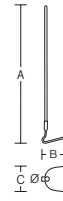

Ref.	A x B x C		Ean
VISORT0090C	1500 x 160 x 32 mm	6	5604612653460

Forquim de cascalho cabo madeira

Horca piedra grava con mango madera

Fork with wooden handle

Fourche à cailloux manche en bois

- › Aço temperado
- › Acero templado
- › Hardened steel
- › Acier trempé



Ref.	A x B x C		Ean
VI1405	1000 x 240 x 350 mm	6	5604612015046

Rodo com cabo em tubo

Raedera con mango en tubo

Scraper with handle

Grattoir avec manche

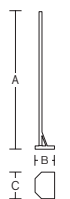

Ref.	A x B x C		Ean
VISORT0091	1455 x 145 x 380mm	6	5604612614423

Forquim cascalho cabo madeira

Horca con mango madera

Fork gravel with handle

Fourche à cailloux

- › Aço temperado
- › Acero templado
- › Hardened steel
- › Acier trempé



Ref.	A x B x C		Ean
VIGANC0102	1110 x 200 x 260 mm	6	5604612614409

Ancinho de construção sem cabo

Rastrillo de construcción sin mango
Construction rake without handle
 Rateau de construction sans manche

› Aço temperado › Hardened steel
 › Acero templado › Acier trempé



Ref.	B x C	⊖	⊞	⊠	Ean
VIANCI0041	150 x 200 mm	38 mm	VI4018	6	5604612614690

Pá de bico tipo francês sem cabo

Pala de punta tipo francês sin mango
Point head shovel french model without handle
 Pelle ronde modèle français sans manche

› Aço temperado › Hardened steel
 › Acero templado › Acier trempé



Ref.	B x C	⊖	⊞	⊠	Ean
VIPBTF	310 x 310 mm		VICPTF	6	5604612638023

Cabo para pá

Mango para pala
Shovel handle
 Manche pour pelle

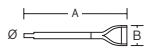

Ref.	A x B	⊖	⊞	⊠	Ean
VI4045	745 x 115 mm	28 mm		25	5604612006464
VI4048	1100 x 115 mm	28 mm		25	5604612653507

Cabo para ancinho › Handle for rake

Mango para rastrillo › Manche pour râteau

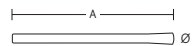

Ref.	A	⊖	⊞	⊠	Ean
VI4010	1400 mm	18 mm	705 g	25	5604612004514

Pega plástica para pá

Empuñadura plástico para pala
D type shovel grip
 Manche plastique pour pelle



Ref.	B x C	⊖	⊞	⊠	Ean
VIPPP	187 x 115 mm	20 mm		100	5604612640439

Rodo espanha redondo albedo

Raedera
Round spanish type scraper
 Grattoir espanhol rond



Ref.	B x C	⊖	⊞	⊠	Ean
VISORT0090	260 x 160 mm	32 mm	VI4010	6	5604612614416

Cabo para pá tipo francês

Mango madera para pala punta tipo frances
Handle for point head shovel french
 Manche pour pelle ronde type français

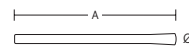

Ref.	A	⊖	⊞	⊠	Ean
VICPTF	1250 mm	38 mm		25	5604612641634

Cabo para enxada › Handle for hoe

Mango para azada › Manche pour houé

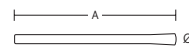

Ref.	A	⊖	⊞	⊠	Ean
VI4018	1285 mm	39 mm	1,0 kg	25	5604612109356



Vassoura aço latonado reforçado › Steel reinforced rake

Escoba de acero reforzado › Balai-brosse fils en acier renforcé

Aço › Chorme steel
Acero › Acier



Ref.		Ean
VIVAR	24	5604612036867

Escova aço latonado › Brass brush

Cepillo de acero › Brosse violon fils en acier

Aço › Chorme steel
Acero › Acier



Ref.		Ean
VIEA	12	5604612036843

Escova aço latonado com cabo e com raspador

Cepillo de acero con mango y con raspador

Brass brush with scraper and handle

Brosse fils en acier avec manche et grattoir

Aço › Chorme steel
Acero › Acier



Ref.		Ean
VIEACR	6	5604612036829

Escova aço inox cabo bimatéria

Cepillo de acero inox mango bimatèrial

Stainless steel brush bimaterial handle

Brosse fils en acier manche bi-matière

Aço inoxidável › Stainless steel
Acero inoxidable › Acier inoxydable



Ref.		Ean
VIEIB	10	5604612036812

Vassoura de estrada com cabo

Escoba camino con mango

Wide broom with handle

Balai-brosse fils en acier avec manche



Ref.	A x B		Ean
VIVE50	1200 x 500 mm	12	5604612649197

Escova aço latonado com cabo

Cepillo de acero con mango

Brass brush with handle

Brosse fils en acier avec manche

Aço › Chorme steel
Acero › Acier



Ref.		Ean
VIEAC	12	5604612036836

Escova aço latonado com cabo plástico

Cepillo de acero con mango plástico

Scratch brush plastic handle

Brosse manche plastique



Ref.		Ean
VIECP	12	5604612170233

Raspador de piso com cabo
Rascador piso con mango
Floor scraper with handle
Grattoir à béton avec manche

- › Aço temperado
- › Acero templado
- › Hardened steel
- › Acier trempé



Ref.	A x B	⊞	Ean
VIRPC	1300 x 300 mm	6	5604612108946

Cabo extensível
Mango extensible
Telescopic handle
Manche télescopique



Ref.	A	⊞	Ean
VICE2M	2 m	6	5604612617073

Cabo vassourão
Mango escoba
Handle for wide broom
Manche pour balai-brosse



Ref.	A	⊞	Ean
VIVARC	1,2 m	25	5604612633271

Rodo de piso
Rodo de piso
Tile wiper
Raclette à plancher



Ref.	A	⊞	Ean
VIRO350	350 mm	23 mm	5604612643010
VIRO450	450 mm	23 mm	5604612643027

Rodo limpa vidros
Rodo limpia vidrios
Water scraper
Raclette lave-vitres



Ref.	A	⊞	Ean
VIRLV	345 mm	25 mm	5604612018658

Raspador de piso › Floor scraper
Rascador de piso › Grattoir à béton

- Aço › Chorme steel
- Acero › Acier

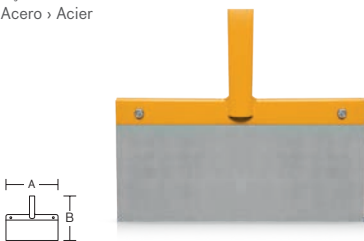

Ref.	A x B	⊞	Ean
VIRP	300 x 150 mm	6	5604612643195

Ventosa › Suction cup
Ventosa › Ventouse

Max 40 KG



Ref.	Ean
VIV25	5604612113476

Ventosa dupla › Double suction cup
Ventosa doble › Ventouse double

Max 80 KG



Ref.	Ean
VIV	5604612018733



Marreta com cabo de fibra › Drilling hammer
Maceta › Massette

Ref.	A x B x C	⊖	⊖	KG	⊞	Ean
VIMB3	910 x 135 x 60 mm	28 mm	VICP	3 kg	6	5604612022365
VIMB4	915 x 150 x 65 mm	30 mm	VICP	4 kg	6	5604612022372
VIMB5	915 x 160 x 70 mm	30 mm	VICP	5 kg	4	5604612022389
VIMB6	915 x 170 x 75 mm	30 mm	VICP	6 kg	4	5604612022396

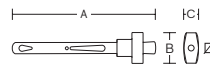

Marreta com cabo de madeira › Drilling hammer with wood handle
Maceta con mango › Massette avec manche en bois



Ref.	A x B x C	⊖	⊖	KG	⊞	Ean
VIM3C	800 x 170 x 59 mm	39 mm	VI4040	3 kg	1	5604612653569
VIM4C	800 x 183 x 62 mm	38 mm	VI4040	4 kg	1	5604612653576
VIM5C	10000 x 190 x 75 mm	37 mm	VI4041	5 kg	1	5604612653583

Marreta › Drilling hammer
Maceta › Massette



Ref.	A x B x C	⊖	KG	⊞	Ean
VIMB1	275 x 90 x 35 mm	28 mm	1,2 kg	6	5604612022358
VIMB125	285 x 100 x 45 mm	28 mm	1,3 kg	6	5604612108670

Marreta sem cabo › Drilling hammer without handle
Maceta sin mango › Masse sans manche

› Aço temperado › Hardened steel
› Acero templado › Acier trempé



Ref.	B x C	⊖	⊖	KG	⊞	Ean
VIM1	115 x 37 mm	24 mm	VI4040	1 kg	10	5604612108700
VIM2	140 x 45 mm	36 mm	VI4040	2 kg	6	5604612108717
VIM3	160 x 51 mm	39 mm	VI4040	3 kg	6	5604612108724
VIM4	175 x 55 mm	38 mm	VI4040	4 kg	6	5604612108731
VIM5	190 x 60 mm	37 mm	VI4041	5 kg	4	5604612108748
VIM6	200 x 64 mm	40 mm	VI4041	6 kg	4	5604612108755
VIM8	220 x 70 mm	47 mm	VI4041	8 kg	4	5604612108762

Marreta › Drilling hammer
Maceta › Massette manche en bois



Ref.	A x B x C	KG	⊞	Ean
VIMM1	270 x 95 x 40 mm	1,0 kg	6	5604612108687
VIMM125	280 x 95 x 45 mm	1,3 kg	6	5604612108694

Marreta tipo espanha › Spanish type stoning hammer
Maceta tipo espana › Massette modèle espagnol



Ref.	A x B x C	⊖	KG	⊞	Ean
VIMEM1	260 x 125 x 35 mm	25 - 30 mm	1,0 kg	6	5604612637590

Maceta cromada › Cone hammer

Maceta cromada › Massette ronde en acier chromé

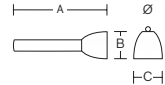

Ref.	A x B x C	⊖	KG	⊞	Ean
VIMC1	60 x 63 x 0 mm	25 mm	VI4900E	1,0 kg	6 5604612153397

Cabo marreta redondo › Drilling handle

Mango maceta redondo › Manche de masse oeil rond

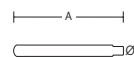

Ref.	A	⊖	KG	⊞	Ean
VI4044	370 mm	30 mm	220 g	25	5604612621544

Cabo fibra para marreta

Mango en fibra para maceta

Bimaterial fiber handle for drilling hammer

Manche de massette en fibre

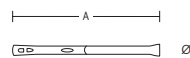

Ref.	A	⊖	KG	⊞	Ean
VICMF	910 mm	46 mm	1,0 kg	20	5604612108779

Cabo de madeira envernizado para maceta

Mango de madeira barnizada para maceta

Varnished wood handle for cone hammer

Manche pour massette bois vernis

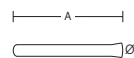

Ref.	A	⊖	KG	⊞	Ean
VI4900E	250 mm	32 mm	110 g	25	5604612644833

Picola › Pointed sledge hammer

Pico › Boucharde double tête

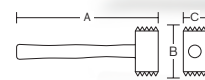

Ref.	A x B x C	KG	⊞	Ean
VI3170	320 x 100 x 40 mm	1,0 kg	6	5604612012786
VI3175	325 x 125 x 40 mm	1,5 kg	6	5604612012793
VI3180	325 x 140 x 50 mm	2,0 kg	6	5604612012809

Cabo marreta oval › Drilling handle

Mango maceta oval › Manche de masse oeil ovale

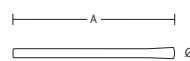

Ref.	A	⊖	KG	⊞	Ean
VI4040	800 mm	38 mm	565 g	25	5604612006457
VI4041	1000 mm	38 mm	645 g	25	5604612102944

Cabo marreta redondo › Drilling handle

Mango maceta redondo › Manche de masse oeil rond

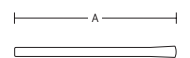

Ref.	A	⊖	KG	⊞	Ean
VI4042	800 mm	38 mm	470 g	25	5604612033774
VI4049	990 mm	40 mm	580 g	25	5604612683429



Ponteiro com proteção › Point chisel with strong grip
 Puntero con protección › Pointerolle avec pare-coups

- › Aço temperado › Hardened steel
- › Acero templado › Acier trempé



Ref.	A x B		Ean
VIPP10	250 x 18 mm	6	5604612012489
VIPP12	300 x 18 mm	6	5604612012496

Talhadeira com proteção › Flat chisel with strong grip
 Cíncel con protección › Burin avec pare-coups

- › Aço temperado › Hardened steel
- › Acero templado › Acier trempé



Ref.	A x B		Ean
VITP10	250 x 18 mm	6	5604612012519
VITP12	300 x 18 mm	6	5604612012502

Ponteiro para pedra › Point chisel
 Puntero para piedra › Pointerolle pour pierre

- › Aço temperado › Hardened steel
- › Acero templado › Acier trempé



Ref.	A x B		Ean
VIP10	250 x 18 mm	12	5604612008406
VIP12	300 x 18 mm	12	5604612008413

Talhadeira para pedra › Stone chisel
 Cíncel para piedra › Burin pour pierre

- › Aço temperado › Hardened steel
- › Acero templado › Acier trempé



Ref.	A x B		Ean
VIT10	250 x 18 mm	12	5604612008444
VIT12	300 x 18 mm	12	5604612008451

Guilho bico › Pointed wedge
 Guillo bico › Coin à bout pointu

- › Aço temperado › Hardened steel
- › Acero templado › Acier trempé



Ref.	A x B		Ean
VI3090	106 x 25 mm	6	5604612033743
VI3091	170 x 25 mm	6	5604612033750
VI3092	214 x 25 mm	6	5604612033767

Guilho cunha › Wedge
 Guillo cunha › Coin

- › Aço temperado › Hardened steel
- › Acero templado › Acier trempé



Ref.	A x B		Ean
VI3095	105 x 25 mm	6	5604612009144
VI3100	156 x 25 mm	6	5604612009151
VI3105	205 x 25 mm	6	5604612009168

Conjunto de 3 escopros de aço › set 3 cold chisel
 Juego de 3 escoplos de acero › Jeu de 3 burins en acier



Ref.	A x B		Ean
VICE3	140 x 10 mm - 150 x 12 mm - 170 x 16 mm	6	5604612684044



Conjunto de 6 punções › Set of 6 pin punches
 Juego de 6 punciones › Jeu de 6 chasse-goupilles



Ref.	A x B		Ean
VICPU6	152 mm Ø: 1,5 3 4 5 6 8 mm	6	5604612684051



**Maço borracha preta › Rubber mallet black**

Maza de caucho negro › Maillet caoutchouc noir



Ref.	A x B x C	/KG	☐	Ean
VIMBP250	300 x 80 x 45 mm	250 g	6	5604612113278
VIMBP450	345 x 95 x 65 mm	450 g	6	5604612113285
VIMBP530	345 x 105 x 60 mm	530 g	6	5604612113292

Maço borracha branca › Rubber mallet white

Maza de caucho branco › Maillet caoutchouc blanc



Ref.	A x B x C	/KG	☐	Ean
VIMBB250	300 x 80 x 45 mm	250 g	6	5604612034542
VIMBB450	345 x 95 x 65 mm	450 g	6	5604612034559
VIMBB530	345 x 105 x 60 mm	530 g	6	5604612034566

Martelo pena › Cross pein hammer

Martillo peña › Marteau panne en travers

› Aço temperado › Hardened steel
› Acero templado › Acier trempé



Ref.	A x B x C	⊖	/KG	☐	Ean
VIMP340	330 x 115 x 27 mm	18 - 23 mm	340 g	6	5604612022327
VIMP400	325 x 120 x 29 mm	18 - 23 mm	400 g	6	5604612022334

Martelo bola cromado › Ball pein hammer

Martillo bola › Marteau à panne ronde

› Aço temperado › Hardened steel
› Acero templado › Acier trempé

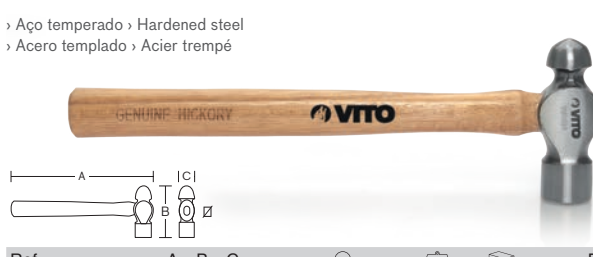

Ref.	A x B x C	⊖	/KG	☐	Ean
VIB300	310 x 89 x 30 mm	18 - 22 mm	300 g	6	5604612008604
VIB500	335 x 100 x 32 mm	18 - 22 mm	500 g	6	5604612008611
VIB700	370 x 110 x 38 mm	20 - 26 mm	700 g	6	5604612008628

Martelo de borracha

Maza de caucho

Rubber hammer

Marteau caoutchouc



Ref.	A x B x C	/KG	☐	Ean
VIM40	304 x 89 x 40 mm	220 g	6	5604612008574
VIM60	313 x 86 x 60 mm	510 g	6	5604612008581
VIM80	325 x 100 x 80 mm	925 g	6	5604612008598

Martelo anti-ressalto com batentes nylon

Martillo anti-ressalto con paradas nylon

Non -recoil hammer with nylon heads

Marteau anti-rebond avec enbouts en nylon



Ref.	A x B x C	⊖	/KG	☐	Ean
VIMAN38	340 x 110 x 37 mm	18 - 28 mm	485 g	6	5604612683450



Martelo cromado › Claw hammer

Martillo de carpintero › Marteau arrache-clou en acier chromé

- › Aço temperado › Hardened steel
- › Acero templado › Acier trempé



Ref.	A x B x C	⊞	Ean
VIM27	345 x 130 x 27 mm	6	5604612008284
VIM29	350 x 140 x 28 mm	6	5604612008291

Martelo carpinteiro › Claw hammer

Martillo carpintero › Marteau arrache-clou

- › Aço temperado › Hardened steel
- › Acero templado › Acier trempé



Ref.	A x B x C	⊞	Ean
VIMCB27	330 x 135 x 30 mm	6	5604612022303

Martelo carpinteiro polido › Claw hammer

Martillo carpintero pulido › Marteau arrache-clou poli

- › Aço temperado › Hardened steel
- › Acero templado › Acier trempé



Ref.	A x B x C	⊞	⊞	⊞	Ean
VIMC27	335 x 130 x 26 mm	16 - 28 mm	VI4910E	6	5604612008758
VIMC29	335 x 140 x 35 mm	16 - 28 mm	VI4910E	6	5604612008765

Martelo marceneiro › Joiner's hammer

Martillo ebanista › Marteau de menuisier

- › Aço temperado › Hardened steel
- › Acero templado › Acier trempé



Ref.	A x B x C	⊞	Ean
VIMM20	270 x 93 x 19 mm	6	5604612637606
VIMM22	280 x 100 x 21 mm	6	5604612637613

Martelo calceteiro com cabo

Martillo de empedrador con mango

Paver hammer with handle

Marteau de paveur manche bois

- › Aço temperado › Hardened steel
- › Acero templado › Acier trempé



Ref.	A x B x C	⊞	⊞	⊞	⊞	Ean
VI3160C	385 x 230 x 80 mm	30 mm	1,0 kg	VI4930E	6	5604612034351

Martelo pedreiro com cabo

Martillo cantero con mango

Mason hammer with handle

Marteau maçon manche bois

- › Aço temperado › Hardened steel
- › Acero templado › Acier trempé



Ref.	A x B x C	⊞	⊞	⊞	⊞	Ean
VI3165C	390 x 20 x 45 mm	27-32 mm	875 g	VI4920E	6	5604612007706

Martelo de abrir rasgos

Martillo abrir rasgones

Multi purpose hatchet hammer

Hachette de plâtrier

› Aço temperado › Hardened steel
› Acero templado › Acier trempé

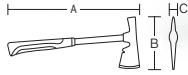
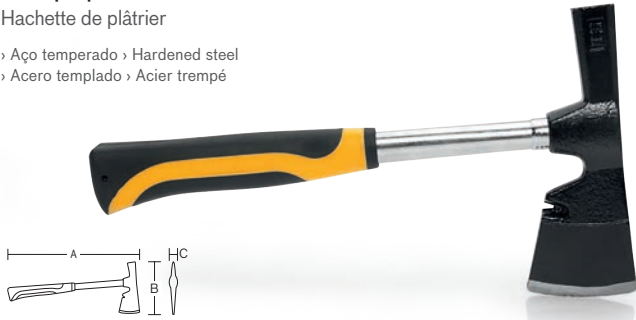

Ref.	A x B x C	⊖	KG	⊞	Ean
VIMRB	325 x 175 x 20 mm			6	5604612022433

Martelo calceteiro sem cabo

Martillo de empedrador sin mango

Paver hammer without handle

Marteau de paveur sans manche

› Aço temperado › Hardened steel
› Acero templado › Acier trempé



Ref.	B x C	⊖	KG	⊞	Ean
VI3160	240 x 80 mm	30 mm	844 g	VI4930E	6 5604612024468

Cabo de madeira envernizado para martelo calceteiro

Mango de madeira barnizada para martillo empedrador

Varnished wood handle for paver hammer

Manche pour marteau paveur bois vernis

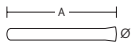

Ref.	A	⊖	KG	⊞	Ean
VI4930E	385 mm	33 mm	190 g		25 5604612644857

Cabo para malho tipo madeira

Mango para majadero tipo madera

Handle fou mould forged cross hammer

Manche pour maillet type bois

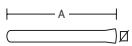

Ref.	A	⊖	KG	⊞	Ean
VI4060	370 mm	31 - 40 mm	192 g		1 5604612663452

Malho tipo madeira com cabo

Majadero tipo madera con mango

Mould forged cross hammer

Maillet type bois avec manche

› Aço temperado › Hardened steel
› Acero templado › Acier trempé

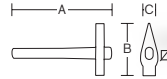

Ref.	A x B x C	⊖	KG	⊞	Ean
VIMTM800	370 x 130 x 40 mm	25 mm	800 g	VI4905E	24 5604612617868
VIMTM1000	370 x 135 x 40 mm	27 mm	1000 g	VI4905E	24 5604612617875
VIMTM1500	370 x 155 x 45 mm	25 mm	1500 g	VI4905E	16 5604612617882
VIMTM2000	370 x 160 x 50 mm	30 mm	2000 g	VI4905E	12 5604612617899

Martelo pedreiro sem cabo

Martillo cantero sin mango

Mason hammer without handle

Marteau maçon sans manche

› Aço temperado › Hardened steel
› Acero templado › Acier trempé

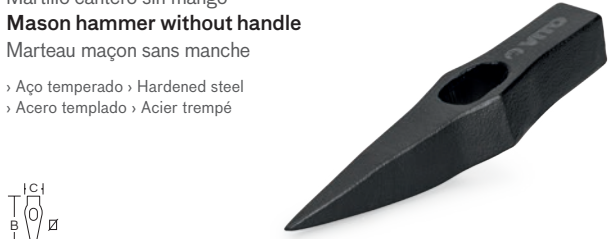

Ref.	B x C	⊖	KG	⊞	Ean
VI3165	200 x 45 mm	27-32 mm	955 g	VI4920	12 5604612030681

Cabo de madeira envernizado para martelo pedreiro

Martillo Mango de madeira barnizada para martillo cantero

Varnished wood handle for mason hammer

Manche pour marteau maçon bois vernis

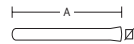

Ref.	A	⊖	KG	⊞	Ean
VI4920E	375 mm	29-35 mm	150 g		25 5604612644871

Cabo madeira envernizado para martelo unha

Mango madeira barnizado para martillo unha

Varnished wood handle for hammer nail

Manche pour marteau ongle bois vernis



Ref.	A	⊖	KG	⊞	Ean
VI4910E	370 mm	14-26 mm	164 g		25 5604612644888



Martelo de cofragem monobloco cabo bimatéria

Martillo de encofrado monobloco mango bimatèrial

Solid 1 piece hammer bimaterial handle

Marteau pavé monobloc manche bi-matière

› Aço temperado › Acero templado › Hardened steel › Acier trempé

Ref.	A x B x C	⊞	Ean
VIMM	335 x 130 x 25 mm	6	5604612683436

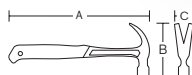

Martelo de cofragem com longo fibra-borracha

Martillo de Encofrado mango largo fibra-goma

Claw hammer long fiber-rubber handle

Marteau pavé poignée en fibre-caoutchouc



Ref.	A x B x C	⊞	Ean
VIMCCL	405 x 120 x 35 mm	6	5604612683443

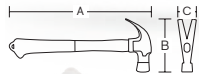

Martelo cofragem

Martillo para listones

French type hammer

Marteau coffreur

› Aço temperado › Hardened steel
› Acero templado › Acier trempé

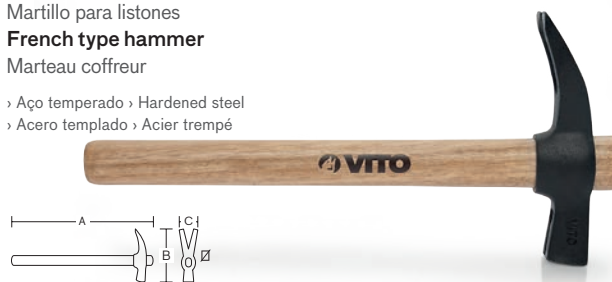

Ref.	A x B x C	⊞	⊞	/KG	⊞	Ean
VIMC700	575 x 180 x 40 mm	30-35 mm	VIMC700SC	925 g	6	5604612012144

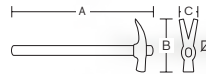

Martelo cofragem 1/2 orelha

Martillo encofrador

Roofing hammer

Marteau coffreur demi-tête

› Aço temperado › Hardened steel
› Acero templado › Acier trempé



Ref.	A x B x C	⊞	Ean
VIMCO	330 x 165 x 25 mm	6	5604612022440

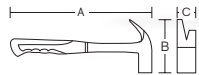

Martelo cofragem 1/2 orelha magnético cabo de fibra

Martillo encofrador magnético mango de fibra

Roofing hammer magnetic fiber handle

Marteau coffreur demi-tête magnétique manche fibre

› Aço temperado › Hardened steel
› Acero templado › Acier trempé



Ref.	A x B x C	/KG	⊞	Ean
VIMCOF	350 x 180 x 30 mm	850 g	6	5604612673154

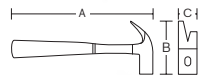

Cabo de madeira envernizado para martelo cofragem

Mango madera barnizada para martillo listones

Varnished wood handle french type hammer

Manche pour marteau coffreur bois vernis



Ref.	A	⊞	/KG	⊞	Ean
VI4905E	375 mm	27 - 38 mm	180 g	25	5604612644864
VI4906E	450 mm	27 - 38 mm	216 g	25	5604612686789

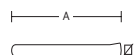

Cabo fibra oval para martelo cofragem

Mango fibra oval para martillo pedrero

Fiber glass handle french type hammer

Manche de marteau coffreur en fibre oeil ovale



Ref.	A	⊞	/KG	⊞	Ean
VICFOMC	365 mm	27 - 40 mm	272 g	10	5604612628666

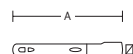

Grampo de pedreiro › Clamp

Grapa cantera › Serre - joint de maçon



Ref.	Nº	Dim.		Ean
VIGP1	1	800 mm	10	5604612016616

Alavanca com 2 bicos › Double pointed end lever

Palanca con 2 punta › Barre - levier avec 2 pointes



Ref.	A x B		Ean
VI3050	1300 x 25 mm	1	5604612112707
VI3055	1500 x 25 mm	1	5604612026677
VI3060	1600 x 28 mm	1	5604612112714
VI3065	1800 x 28 mm	1	5604612112721

Chaviete redondo

Fijarregla redondo

Round mason's pin

Chevillette ronde



Ref.	Dim.		Ean
VI3080R	250 mm	40	5604612006846

Chave amarrar ferro

Llave para atar hierro

Iron wire folder

Clé à fer



Ref.		Ean
VICAFM	10	5604612632434

Pé de cabra

Desencofrador

Crow-bar

Pied de biche



Ref.	Dim.		Ean
VIP40	400 mm	6	5604612021283
VIP50	500 mm	6	5604612021290
VIP60	600 mm	6	5604612008475
VIP70	700 mm	6	5604612008482
VIP80	800 mm	6	5604612008499
VIP100	1000 mm	6	5604612008505

Enxó com cabo › Adze with handle

Azuela con mango › Herminette de charpentier

› Aço temperado › Hardened steel

› Acero templado › Acier trempé



Ref.		Ean
VI EC1	10	5604612008949

Alavanca com pá e bico › Lever shovel/pointed end

Palanca con pala y punta › Barre - levier plate/pointe



Ref.	A x B		Ean
VI3010	1300 x 25 mm	1	5604612033682
VI3015	1500 x 25 mm	1	5604612009007
VI3020	1600 x 28 mm	1	5604612033699

Chaviete quadrado

Fijarregla cuadrada

Square mason's pin

Chevillette carrée



Ref.	Dim.		Ean
VI3080Q	250 mm	40	5604612098179

Chave amarrar ferro

Llave para atar hierro

Iron wire folder

Clé à fer



Ref.		Ean
VICAF	100	5604612014711

Chave dobrar ferro

Llave de grifa

Wrecking bar

Griffe à cintrer



Ref.	A x B		Ean
VICDF68	6 x 8 mm	50	5604612017149
VICDF1012	10 x 12 mm	30	5604612017156
VICDF1416	14 x 16 mm	20	5604612017163



Talocha dentada em aço inoxidável e cabo bimatéria
 Llana dentada en acero inoxidable y mango bimatérial
Stainless steel notch trowel with bi-material handle
 Platoir denté en acier inoxydable et manche bi-matière



Ref.	A x B	mm		Ean
VITDIB2806	130 x 280 mm	6 x 6 mm	6	5604612677206
VITDIB2808	130 x 280 mm	8 x 8 mm	6	5604612677213
VITDIB28010	130 x 280 mm	10 x 10 mm	6	5604612677220



Talocha lisa em aço inoxidável e cabo bimatéria
 Llana lisa en acero inoxidable y mango bimatérial
Stainless steel plastering trowel with bi-material handle
 Platoir lisse en acier inoxydable et manche bi-matière



Ref.	A x B		Ean
VITLIB280	130 x 280 mm	6	5604612677190



Talocha dentada com cabo bimatéria
 Llana dentada con mango bimatérial
Notch trowel with bi-material handle
 Platoir denté avec manche bi-matière



Ref.	A x B	mm		Ean
VITDB2806	130 x 280 mm	6 x 6 mm	6	5604612677169
VITDB2808	280 x 130 mm	8 x 8 mm	6	5604612677176
VITDB2810	280 x 130 mm	10 x 10 mm	6	5604612677183



Talocha lisa com cabo bimatéria
 Llana lisa con mango bimatérial
Plastering trowel with bi-material handle
 Platoir lisse avec manche bi-matière



Ref.	A x B		Ean
VITLB280	130 x 280 mm	6	5604612677152



Talocha dentada em aço inoxidável e cabo de madeira

Llana dentada en acero inoxidable y mango de madera

Stainless steel notch trowel with wooden handle

Platoir denté en acier inoxydable et manche à bois



Ref.	A x B	H	Ean
VITDIM5008	130 x 500 mm	8 mm	5604612677244
VITDIM50010	130 x 500 mm	10 mm	5604612677251

Talocha lisa em aço inoxidável e cabo de madeira

Llana lisa en acero inoxidable y mango de madera

Stainless steel plastering trowel with wooden handle

Platoir lisse en acier inoxydable et manche à bois



Ref.	A x B	Ean
VITLIM500	130 x 500 mm	5604612677237

Talocha de bico

Llana pontiaguda

Angled plastering trowel

Taloche plastique pointue



Ref.	Nº	A x B	Ean
VITB1	1	140 x 265 mm	5604612034177

Talocha de plástico

Llana plástico

Plastic trowel

Taloche plastique



Ref.	Nº	A x B	Ean
VITP1	1	160 x 270 mm	5604612093525
VITP2	2	220 x 340 mm	5604612005351
VITP3	3	260 x 420 mm	5604612005375

Desempeno

Llana estrecha

Straightener

Taloche



Ref.	Nº	A x B	Ean
VIDP1	1	30 x 330 mm	5604612005382
VIDP2	2	51 x 355 mm	5604612170639
VIDP3	3	68 x 375 mm	5604612038670

Talocha borracha

Llana caucho

Float rubber

Taloche caoutchouc



Ref.	A x B x C	Ean
VITBP	140 x 280 x 10 mm	5604612114350

Talocha para gesso

Llana para yeso

Float for plaster

Platoir pour plâtre



Ref.	A x B	Ean
VITG	140 x 280 mm	5604612623869

Talocha borracha para juntas

Llana caucho para juntas

Heavy density float

Taloche à joint en caoutchouc



Ref.	A x B	Ean
VITBJ	100 x 300 mm	5604612113360



Talocha esponja
Llana esponja
Float sponge
Taloche éponge



Ref.	A x B x C	HC	Ean
VITEL	140 x 280 x 20 mm	6	5604612114343

Talocha de espuma
Llana de espuma
Hidro sponje float
Taloche mousse



Ref.	A x B x C	HC	Ean
VITEA	140 x 280 x 20 mm	6	5604612114367

Talocha de espuma cortada amarela
Llana de espuma cortada amarilla
Sponge float with cut yellow
Taloche mousse profilée jaune



Ref.	A x B x C	HC	Ean
VITEAC	140 x 280 x 20 mm	6	5604612619978

Rascador de cemento cabo plástico
Rascador de cemento mango plástico
Plastic handle cement scraper
Grattoir d'enduit manche plastique



Ref.	A x B	HC	Ean
VIRC250	145 x 250 mm	5	5604612673703

Rascador de gesso
Rascador yeso
Plaster scraper
Grattoir pour plâtre



Ref.	A x B	HC	Ean
VIRG585	85 x 450 mm	8	5604612643034

Talocha lixadora
Llana lijadora
Drywall hand sander
Taloche à poncer



Ref.	A x B	HC	Ean
VICL5	82 x 235 mm	10	5604612024635

Talocha lixadora sem cabo › Pole sander
Llana lijadoras sin mango › Pole sander



Ref.	A x B	HC	Ean
VITL5SC	85 x 225 mm	6	5604612113247

Cabo para talocha lixadora › Cabel for pole sander
Mango para talocha › Manche pour taloche à poncer



Ref.	Dim.	HC	Ean
VICTL	1400 mm	36	5604612139186



Colher forjada cantos direitos e cabo bimatéria
 Paleta forjada portuguesa y mango bimaterial
Portuguese model forged trowel with bi-material handle
 Truelle forgée ronde chants droits et manche bi-matière

› Aço temperado › Hardened steel
 › Acero templado › Acier trempé

Colher forjada cantos cortados e cabo bimatéria
 Paleta forjada madrileña con mango bimaterial
Forged trowel Madrid pattern and bi-material handle
 Truelle forgée modèle Madrid et manche bi-matière

› Aço temperado › Hardened steel
 › Acero templado › Acier trempé



Ref.	Dim.	📦	Ean
VICFDB220	220 mm	10	5604612617745
VICFDB240	240 mm	10	5604612617752

Ref.	Dim.	📦	Ean
VICFCB220	220 mm	10	5604612617776
VICFCB240	240 mm	10	5604612617783

Colher forjada cantos direitos

Paleta forjada esquinas derechas

Forged trowel portuguese pattern

Truelle ronde forgée

› Aço temperado › Hardened steel
› Acero templado › Acier trempé



Ref.	Dim.		Ean
VICFD220	220 mm	10	5604612170547
VICFD240	240 mm	10	5604612170561

Colher cantos direitos

Paleta cantos planos

Straight corners trowel portuguese pattern

Truelle ronde

Aço inoxidável › Stainless steel
Acero inoxidable › Acier inoxydable



Ref.	Dim.		Ean
VICID220	220 mm	6	5604612643119

Colher forjada tipo norte

Paleta forjada tipo norte

Forged trowel north pattern

Truelle forgée modèle nord

› Aço temperado › Hardened steel
› Acero templado › Acier trempé

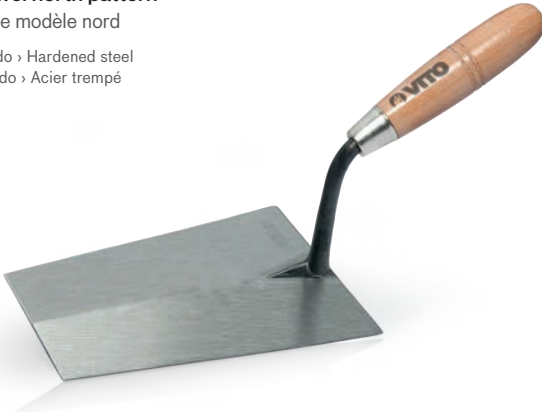

Ref.	Dim.		Ean
VICFN180	180 mm	10	5604612637576
VICFN190	190 mm	10	5604612637583

Colher

Paleta

Trowel

Truelle

Aço inoxidável › Stainless steel
Acero inoxidable › Acier inoxydable



Ref.	Dim.		Ean
VIC170	70 mm	6	5604612642938
VIC180	80 mm	6	5604612642945
VIC100	100 mm	6	5604612642952

Colher forjada cantos cortados

Paleta forjada esquinas cortadas

Forged trowel Madrid pattern

Truelle forgée modèle Madrid

› Aço temperado › Hardened steel
› Acero templado › Acier trempé



Ref.	Dim.		Ean
VICFC220	220 mm	10	5604612170585
VICFC240	240 mm	10	5604612170608

Colher cantos cortados

Paleta esquinas cortadas

Cut corners trowel Madrid pattern

Truelle ronde modèle Madrid

Aço inoxidável › Stainless steel
Acero inoxidable › Acier inoxydable



Ref.	Dim.		Ean
VICIC220	220 mm	6	5604612643126

Colher forjada tipo catalã

Paleta forjada tipo catalan

Forged trowel catalan pattern

Truelle forgée modèle catalan

› Aço temperado › Hardened steel
› Acero templado › Acier trempé

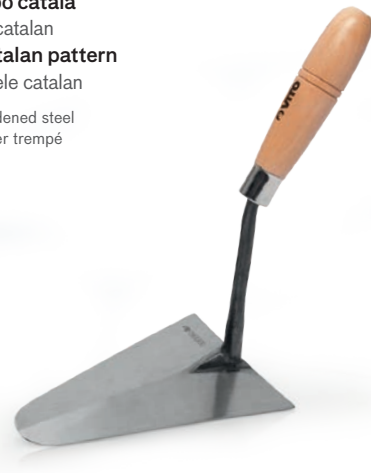

Ref.	Dim.		Ean
VICFCT165	165 mm	10	5604612637552
VICFCT180	180 mm	10	5604612637569

Colher estucador

Paleta estucador

Plasterer trowel

Truelle plâtrier

Aço inoxidável › Stainless steel
Acero inoxidable › Acier inoxydable



Ref.	Dim.		Ean
VICIE120	120 mm	6	5604612642969
VICIE160	160 mm	6	5604612642976

Colher cantos internos

Paleta cantos internos

Internal corners trowel

Truelle coin intérieur

Aço inoxidável › Stainless steel
Acero inoxidable › Acier inoxydable

Ref.	Dim.	📦	Ean
VICCI80	80 mm	6	5604612642983
VICCI100	100 mm	6	5604612643003

Colher forjada bico redondo

Paleta forjada punta redonda

Forged trowel point round

Truelle forgée bout rond

› Aço temperado › Hardened steel
› Acero templado › Acier trempé

Ref.	Dim.	📦	Ean
VICFBR120	120 mm	10	5604612170615

Colher bico redondo

Paletín punta redonda

Trowel point round

Truelle bout rond

Aço inoxidável › Stainless steel
Acero inoxidable › Acier inoxydable

Ref.	Dim.	📦	Ean
VICBR125	125 mm	6	5604612643188

Colher mata juntas

Paleta para junta

Glue scraper

Truelle fer à joints



Ref.	Dim.	📦	Ean
VICMJ12	12 mm	6	5604612643232
VICMJ14	14 mm	6	5604612643249
VICMJ16	16 mm	6	5604612643256

Colher cantos externos

Paleta cantos externos

External corners trowel

Truelle coin extérieur

Aço inoxidável › Stainless steel
Acero inoxidable › Acier inoxydable

Ref.	Dim.	📦	Ean
VICCE80	80 mm	6	5604612642990
VICCE100	100 mm	6	5604612617837

Colher forjada bico

Paleta forjada punta

Forged trowel pointed

Truelle forgée pointue

› Aço temperado › Hardened steel
› Acero templado › Acier trempé

Ref.	Dim.	📦	Ean
VICFB120	120 mm	10	5604612170622

Colher de bico

Paletín

Trowel pointed

Truelle triangulaire

Aço inoxidável › Stainless steel
Acero inoxidable › Acier inoxydable

Ref.	Dim.	📦	Ean
VICB125	125 mm	6	5604612643171

Colher beira

Paleta

“Beira” type trowel

Modèle “Beira”



Ref.	Dim.	📦	Ean
VICB20	20 mm	6	5604612643058
VICB30	30 mm	6	5604612643065



Espátula com cabo bimatéria
 Espátula con mango bimatèrial
Taping knife bimatèrial handle
 Spatule manche bi-matière

Aço inoxidável › Stainless steel
 Acero inoxidable › Acier inoxydable



Ref.	A	B		Ean
VIEI150B	150 mm	260 mm	10	5604612637514
VIEI200B	200 mm	260 mm	10	5604612637521



Espátula flexível
aço inoxidável
com cabo bimatéria
 Espátula flexível
 acero inoxidable
 con mango bimatèria
Flexible stainless
steel scraper
bimatèrial handle
 Spatule flexível
 acier inoxydable
 manche bi-matière



Ref.	A	B		Ean
VIEFI25	25 mm	220 mm	10	5604612658724
VIEFI38	38 mm	220 mm	10	5604612658731
VIEFI50	50 mm	220 mm	10	5604612658748
VIEFI63	63 mm	220 mm	10	5604612658755
VIEFI75	75 mm	220 mm	10	5604612658762
VIEFI100	100 mm	225 mm	10	5604612658779
VIEFI125	125 mm	225 mm	10	5604612658786



Espátula com
cabo bimatéria
 Espátula con
 mango bimatèrial
Scraper with
bimatèrial handle
 Spatule avec
 manche bi-matière



Ref.	A	B		Ean
VIEFB25	25 mm	215 mm	12	5604612113384
VIEFB38	38 mm	215 mm	12	5604612113391
VIEFB50	50 mm	215 mm	12	5604612113407
VIEFB63	63 mm	215 mm	12	5604612113414
VIEFB75	75 mm	215 mm	12	5604612113421
VIEFB100	100 mm	220 mm	12	5604612113438
VIEFB125	125 mm	220 mm	12	5604612113445



Espátula lisa › Scraper

Espátula lisa › Spatule lisse



Ref.	A	📦	Ean
VIEL160	160 mm	10	5604612643133
VIEL200	200 mm	10	5604612643140
VIEL250	250 mm	10	5604612643157

Espátula ladrilhador borracha

Espátula ladrillero caucho

Grout spreader wood handle

Spatule carreleur caoutchouc

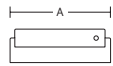

Ref.	A	📦	Ean
VIELB200	200 mm	6	5604612018641
VIELB300	300 mm	6	5604612018634

Conjunto de 3 peças para ladrilhador

Juego de 3 piezas para ladrillero

Set of 3 Pieces set for tile-layer

Jeu de 3 pièces pour carreleur



Ref.	📦	Ean
VIL3	10	5604612650223

Espátula estucador › Plasterer scraper

Espatula estocador › Spatules de plâtrier

Aço inoxidável › Stainless steel

Acero inoxidable › Acier inoxydable



Ref.	B	📦	Ean
VIEE20	20 mm	6	5604612643041

Espátula dentada › Scraper square

Espátula dentada › Spatule dentée

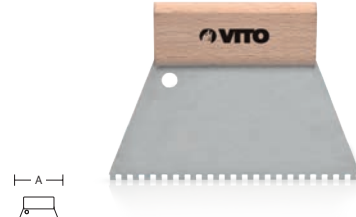

Ref.	A	📦	Ean
VIEID180	180 mm	10	5604612643218
VIEID250	250 mm	10	5604612643225

Espátula para gesso

Espátula para yeso

Plaster scraper

Spatule pour plâtre

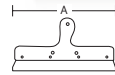

Ref.	Dim.	📦	Ean
VIEGI400	400 mm	10	5604612638498
VIEGI500	500 mm	10	5604612638504
VIEGI600	600 mm	10	560461263968

Espátula dentada › Scraper square

Espátula dentada › Spatule dentée

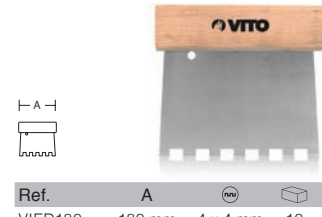

Ref.	A	📦	Ean
VIED180	180 mm	10	5604612642914
VIED1808	180 mm	10	5604612113346
VIED250	250 mm	10	5604612643089
VIED2508	250 mm	10	5604612113353
VIED300	300 mm	10	5604612643201

Espátula

Espatula

Putty knife scraper

Spatule



Ref.	Dim.	📦	Ean
VIR200	200 mm	6	5604612113452
VIR250	250 mm	6	5604612113469

Conjunto de 4 betumadeiras

Juego de 4 betumaderas

Set of 4 putty knife

Jeu de 4 spatules



Aço carbono › Chorme steel
Acero cromado › Acier chromé



Ref.	A	📦	Ean
VIJBA	50 80 100 120 mm	10	5604612109721

Esponja › Sponge

Esponja › Éponge



Ref.	Dim.	📦	Ean
VIEP45	170 x 120 x 50 mm	100	5604612016449
VIEP60	170 x 120 x 60 mm	100	5604612016456



Kit balde + talocha + esponja + rolos
 Kit cubo + llana + esponja + rollos
Bucket set + float + sponge + grinding rollers
 Kit seau + taloche + éponge + rouleau



Ref.	CAP.		Ean
VIBER	23 L	4	5604612114374

Gamela reforçada em pvc › Pvc reinforced tray
 Cubeta reforzada en pvc › Auge de maçon en pvc



Ref.	CAP.	A x B x C		Ean
VIGR	25 L	400 x 600 x 105 mm	5	5604612012434

Gamela de borracha › Rubber trough
 Cubeta de caucho › Auge en caoutchouc



Ref.	CAP.	A x B x C		Ean
VIGB030	30 L	465 x 595 x 160 mm	10	5604612107338
VIGB040	40 L	500 x 685 x 190 cm	10	5604612107345

Gamela de plástico › Plastic tray
 Cubeta de plástico › Auge de maçon en plastique



Ref.	CAP.	Dim.		Ean
VIGP40	12,5 L	400 x 510 x 105 mm	15	5604612005597

Balde de borracha
 Cubo de caucho
Rubber bucket
 Seau en caoutchouc



Ref.	CAP.		Ean
VIBB12	12 L	10	5604612107321

Balde de plástico
 Cubo de plástico
Plastic bucket
 Seau plastique



Ref.	CAP.		Ean
VIBPL10	10 L	25	5604612005580
VIBPL15	15 L	25	5604612015077

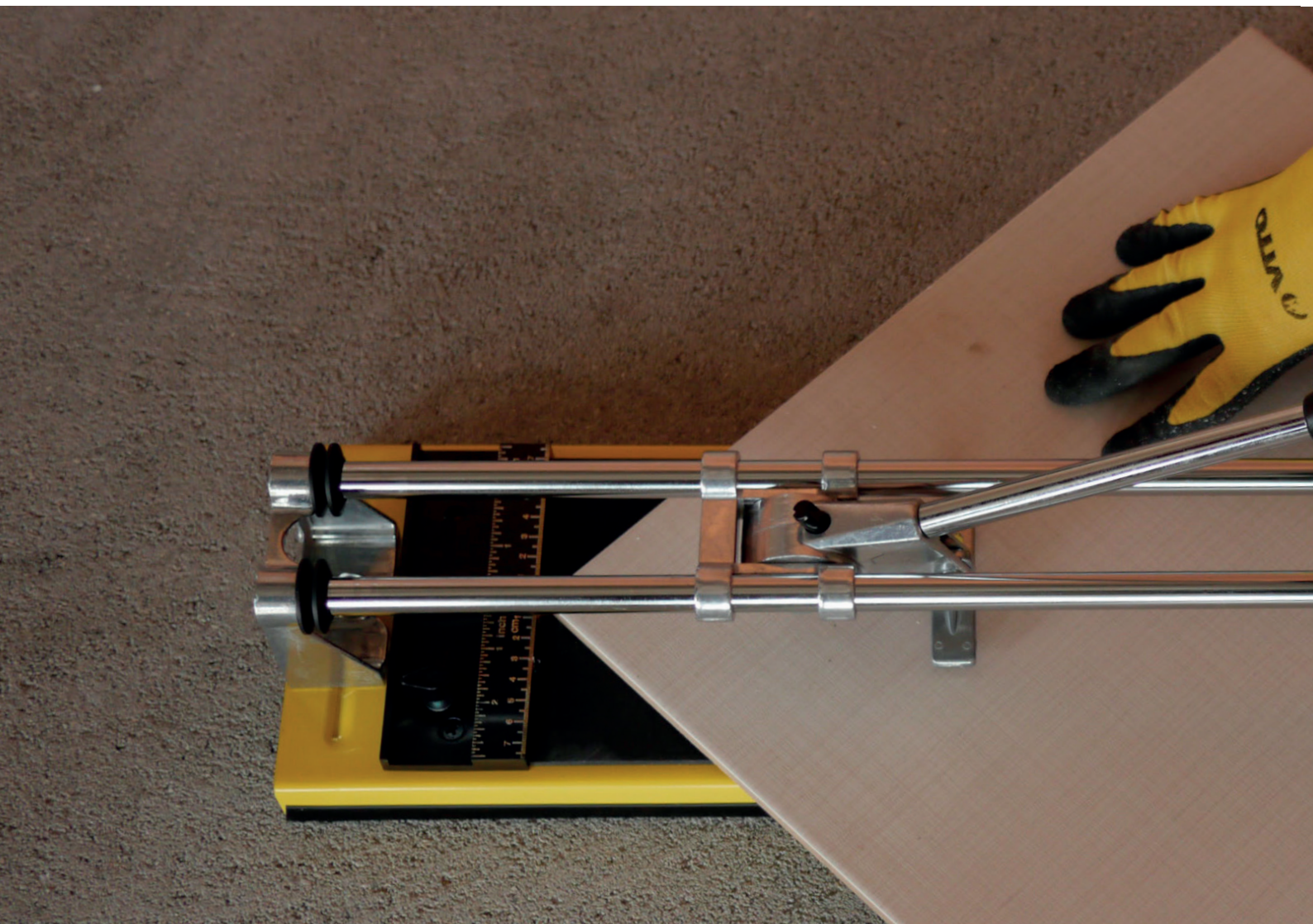

Máquina de cortar azulejo Pro

Cortadora de azulejos Pro

Pro tile cutter

Coupe-carreaux Pro



Ref.	Dim.		Ean
VIMCA800	800 mm	2	5604612684839
VIMCA1200	1200 mm	2	5604612684846



Máquina de cortar azulejo
Cortadora de azulejos
Pro tile cutter
Coupe-carreaux



Ref.	Dim.		Ean
VIMCA600B	600 mm	2	5604612030537

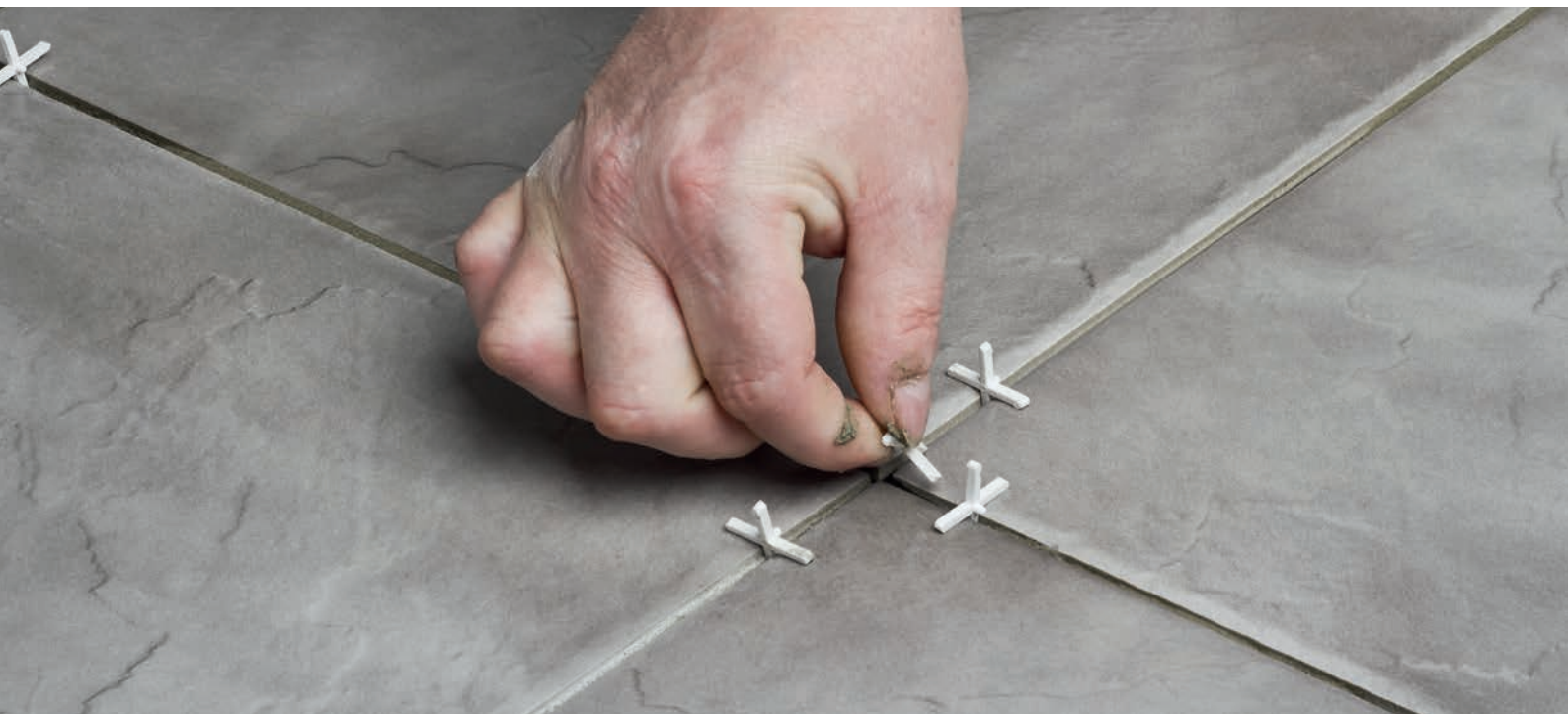

Cruzetas para cerâmica

Crucetas para cerâmica

Ceramic's crosspieces

Croisillons pour carrelage



Ref.	Dim.	Pack	📦	Ean
VICZ1	1 mm	250 un.	6	5604612024840
VICZ2	2 mm	250 un.	6	5604612011512
VICZ25	2,5 mm	250 un.	6	5604612011505
VICZ3	3 mm	250 un.	6	5604612011529
VICZ4	4 mm	250 un.	6	5604612011536
VICZ5	5 mm	200 un.	6	5604612011543
VICZ6	6 mm	200 un.	6	5604612011550
VICZ7	7 mm	200 un.	6	5604612024857
VICZ8	8 mm	200 un.	6	5604612011567
VICZ10	10 mm	200 Un	6	5604612024864

Cunhas para cerâmica › Ceramic's wedges

Cuñas para cerâmica › Cales pour pose de carreaux



Ref.	Dim.	Pack	📦	Ean
VIBC500	0-5 mm	500 un.	6	5604612024871

Turquês de cerâmica › Tile holder nipper

Tenaza rusa de cerâmica › Tenaille pour carrelleur

CrV
Chrome
Vanadium

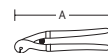

Ref.	A	📦	Ean
VITC	200 mm	6	5604612113308

Cortante › Scoring wheel

Rulina › Molette pour coupe-carreaux

Universal



Ref.	Dim.	📦	Ean
VIC6	6 mm	12	5604612035907
VIC8	8 mm	12	5604612650605
VIC10M	10 mm	12	5604612650612



Conjunto fio de marcar, pó e nivelador
 Juego hilo para marcar, polvillo y nivelador de hilo
Chalk line with powder and string leveler
 Cordeau à tracer, craie et niveleur de ficelle



Fio de marcar
 Hilo para marcar
Chalk line
 Cordeau à tracer



Pó de marcar
 Polvillo de marcar
Powder
 Craie



Ref.		Ean
VIFMPO	10	5604612103071



Ref.	Dim.		Ean
VIFM15	15 m	10	5604612103088



Ref.	KG		Ean
VIPM250	250 g	10	5604612103095

Conjunto fio de marcar metálico e pó
 Juego hilo para marcar metalico e polvillo
Metal chalk line with powder
 Cordeau à tracer métallique et craie



Fio de marcar metálico
 Hilo para marcar metalico
Metal chalk line
 Cordeau à tracer métallique



Fio de alinhamento
 Hilo de alineamiento
PE twine
 Bobine de fil pour alignement



Ref.		Ean
VIFMMP0	4	5604612632441



Ref.	Dim.		Ean
VIFMM	30 m	10	5604612632458



Ref.	KG		Ean
VIFIA250	250 g	12	5604612007478



Prumo de centro

Plomada central

Plumb bob

Fil à plomb de centre



Ref.	KG		Ean
VIP400	400 g	6	5604612008321

Prumo tipo pião com chumbo

Plomada tipo peón con plomo

Plumb bob with tip wooden buoy

Fil à plomb forme toupie avec flotteur en bois



Ref.	Nº		Ean
VIPIBM7	7	4	5604612033934
VIPIBM8	8	4	5604612033941

Prumo polido envernizado

Plomada pulido barnizado

Polished varnished plumb bob

Fil à plomb poli et vernis



Ref.	KG		Ean
VIP550	500 g	6	5604612008338
VIP750	700 g	6	5604612008345

Prumo tipo peso

Plomada tipo peso

Plumb bob

Fil à plomb forme poids



Ref.	Nº		Ean
VIPPE5	5	4	5604612006631
VIPPE6	6	4	5604612006648

Fio de prumo

Hilo de plomo

Wire

Bobine de fil pour fil à plomb



Ref.	Dim.		Ean
VIFPR50	50 m	6	5604612087135
VIFPR50B	50 m	6	5604612662011

Prumo tipo pião

Plomada tipo peón

Plumb bob with tip

Fil à plomb forme toupie



Ref.	Nº		Ean
VIPI5	5	4	5604612016425
VIPI6	6	4	5604612017712



Fita métrica longa
Flexómetro longo
Long tape measure
Mètre à ruban



Ref.	Dim.	📦	Ean
VIFML20	20 x 13 mm	60	5604612616359
VIFML30	30 x 13 mm	60	5604612616366
VIFML50	50 x 13 mm	30	5604612616373

Fita métrica revestida a nylon com íman
Flexómetro revestido a nylon con íman
Nylon coated tape measure with magnetic tip
Mètre à ruban nylon à embout magnétique



Ref.	Dim.	📦	Ean
VIF3B	3 m x 16 mm	12	5604612026417
VIF5B	5 m x 16 mm	12	5604612026424
VIF8B	8 m x 25 mm	6	5604612026431

Fita métrica cromada
Flexómetro cromado
Chromed tape measure
Mètre à ruban chromé



Ref.	Dim.	📦	Ean
VIFCR3	3 m x 16 mm	12	5604612657222
VIFCR5	5 m x 16 mm	12	5604612657239
VIFCR8	8 m x 25 mm	6	5604612657246

Fita métrica
Flexómetro
Tape measure
Mètre à ruban



Ref.	Dim.	📦	Ean
VIFB3B	3 m x 16 mm	12	5604612035280
VIFB5B	5 m x 16 mm	12	5604612035297
VIFB8B	8 m x 25 mm	6	5604612035303



Paquímetro digital

Calibre digital

Digital caliper

Pied à coulisse digital

Aço inoxidável › Stainless steel

Acero inoxidable › Acier inoxydable



Ref.	Dim.		Ean
VIPQD150	150 mm	10	5604612683665

Esquadro de carpinteiro

Escuadro de carpintero

Try square

Équerre de menuisier

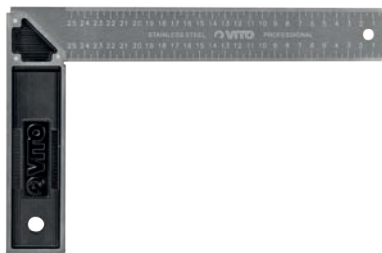

Ref.	Dim.		Ean
VIEC250	250 mm	6	5604612683634
VIEC300	300 mm	6	5604612683641
VIEC350	350 mm	6	5604612683658

Paquímetro

Calibre pie de rey

Vernier caliper

Pied à coulisse

Aço inoxidável › Stainless steel

Acero inoxidable › Acier inoxydable



Ref.	Dim.		Ean
VIPQ150	150 mm	10	5604612028633

Esquadro para pedreiro

Escuadro cantero

Black iron square

Équerre de maçon



Ref.	Dim.		Ean
VIEP	400 x 600 mm	6	5604612028411



Nível alumínio Pro › Heavy duty aluminium level
 Nivel aluminio Pro › Niveau à bulle pro

Precision
 0,5 mm/m

Ref.	Dim.					Ean
VINAP45	450 mm	1	1	1	40	5604612658991
VINAP60	600 mm	1	1	1	30	5604612628963
VINAP80	800 mm	1	1	1	30	5604612628970
VINAP100	1000 mm	1	1	1	20	5604612628987
VINAP120	1200 mm	1	1	1	5	5604612628994



Nível torpedo magnético › Magnetic bridge level
 Nivel 2 burbujas ala de avión magnético › Niveau à bulle trapézoïdal

Precision
 0,5 mm/m



Ref.	Dim.				Ean
VINTM25	250 mm	1	1	10	5604612629007

Nível torpedo › Torpedo level
 Nivel ala avion › Niveau trapezoidal

Precision
 1 mm/m



Ref.	Dim.				Ean
VINT40	400 mm	1	1	30	5604612021931
VINT60	600 mm	1	1	30	5604612021955

Nível alumínio › Aluminium level
 Nivel 3 burbujas aluminio › Niveau à bulle

Precision
 0,5 mm/m



Ref.	Dim.					Ean
VINA45	450 mm	1	1	1	50	5604612658984
VINA60	600 mm	1	1	1	50	5604612628901
VINA80	800 mm	1	1	1	40	5604612628918
VINA100	1000 mm	1	1	1	30	5604612628925
VINA120	1200 mm	1	1	1	20	5604612628932

Nível tipo régua › Ruler type level
 Nivel 2 burbujas aluminio › Règle de maçon

Precision
 1 mm/m



Ref.	Dim.				Ean
VINR150	1500 x 100 x 20 mm	1	1	10	5604612172350
VINR200	2000 x 100 x 20 mm	1	1	10	5604612172367

Régua de alumínio › Aluminium ruler
 Regleta aluminio › Règle aluminium avec embouts

Precision
 1 mm/m



Ref.	Dim.		Ean
VIREA2	2000 x 100 x 20 mm	10	5604612014209
VIREA25	2500 x 100 x 20 mm	10	5604612113124
VIREA3	3000 x 100 x 20 mm	10	5604612102593
VIREA4	4000 x 100 x 20 mm	10	5604612102609
VIREA5	5000 x 100 x 20 mm	10	5604612118488
VIREA6	6000 x 100 x 20 mm	10	5604612118495

Pintura

Pintura

Painting

Peinture



Rolo paredes e fachadas lisas
 Rodillo paredes y fachadas lisas
Paint roller for smooth surface
 Rouleau peinture surfaces lisses



Ref.	Dim.		Ean
VIRPFL180	180 mm	1	5604612684518
VIRPFL250	250 mm	1	5604612684525

Rolo paredes areadas
 Rodillo paredes areadas
Long fiber paint roller
 Rouleau fibre longue



Ref.	Dim.		Ean
VIRPA150	150 mm	1	5604612684556
VIRPA180	180 mm	1	5604612684563
VIRPA250	250 mm	1	5604612684570

Rolo efeito areia
 Rodillo efecto area
Paint roller for sand effect
 Rouleau peinture crépi



Ref.	Dim.		Ean
VIREA180	180 mm	1	5604612684471
VIREA250	250 mm	1	5604612684488

Rolo fachadas irregulares
 Rodillo fachadas rugosas
Roller for rough surface
 Rouleau pour façade rugueuse



Ref.	Dim.		Ean
VIRFI180	180 mm	1	5604612684709
VIRFI250	250 mm	1	5604612684716

Rolo acabamentos paredes lisas

Rodillo acabado paredes lisas

Paint roller for smooth finishes

Rouleau finition surface lisse



Ref.	Dim.		Ean
VIRAPL110	110 mm	1	5604612684747

Recarga rolo paredes e fachadas lisas

Recarga rodillo paredes y fachadas lisas

Paint roller refill for smooth surface

Recharge rouleau peinture surfaces lisses



Ref.	Dim.		Ean
VIRRPFL180	180 mm	1	5604612684532
VIRRPFL250	250 mm	1	5604612684549

Recarga rolo fachadas irregulares

Recarga rodillo fachadas rugosas

Roller refill for rough surface

Recharge rouleau pour façade rugueuse



Ref.	Dim.		Ean
VIRRFI180	180 mm	1	5604612684723
VIRRFI250	250 mm	1	5604612684730

Recarga rolo madeira metal e pvc

Recarga rodillo madera metal y pvc

Roller refill for wood metal and pvc

Recharge pour rouleau bois métal et pvc



Ref.	Dim.		Ean
VIRRMMP150	150 mm	1	5604612684655
VIRRMMP180	180 mm	1	5604612684679
VIRRMMP250	250 mm	1	5604612684693

Rolo madeira metal e pvc

Rodillo madera metal y pvc

Roller for wood metal and pvc

Rouleau pour bois métal et pvc



Ref.	Dim.		Ean
VIRMMP150	150 mm	1	5604612684648
VIRMMP180	180 mm	1	5604612684662
VIRMMP250	250 mm	1	5604612684686

Recarga rolo paredes areadas

Recarga rodillo paredes areadas

Roller refill with long fiber

Recharge pour rouleau fibre longue



Ref.	Dim.		Ean
VIRRPA150	150 mm	1	5604612684587
VIRRPA180	180 mm	1	5604612684594
VIRRPA250	250 mm	1	5604612684600

2 Recargas rolo acabamentos paredes lisas

2 Recargas rodillos acabado paredes lisas

Set of 2 paint roller refill for smooth finishes

Lot 2 rouleau finition surface lisse

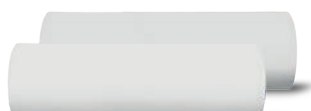

Ref.	Dim.		Ean
VIRRAPL110	110 mm	1	5604612684754

2 Recargas rolo madeira metal e pvc

2 Recargas rodillo madera metal y pvc

Set of 2 small roller refill for wood metal and pvc

Lot de 2 recharges pour rouleau bois métal et pvc



Ref.	Dim.		Ean
VIRRMMP60	60 mm	1	5604612684099
VIRRMMP110	110 mm	1	5604612684631

Rolo madeira metal e pvc

Rodillo madera metal y pvc

Small roller for wood metal and pvc

Rouleau pour bois métal et pvc



Ref.	Dim.		Ean
VIRMMP60	60 mm	1	5604612684617
VIRMMP110	110 mm	1	5604612684624

Recarga rolo efeito areia

Recarga rodillo efecto area

Paint roller refill for sand effect

Recharge rouleau peinture crépi



Ref.	Dim.		Ean
VIRREA180	180 mm	1	5604612684495
VIRREA250	250 mm	1	5604612684501

Cabo extensível

Mango extensible

Telescopic handle

Manche télescopique

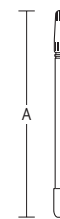

Ref.	A		Ean
VICE2M	2 m	6	5604612617073



Trincha júnior › Paint brush
Paletina junior › Pinceau plat

Ref.	Dim.	☐	Ean
VITJ12	1/2" - 12,5 mm	12	5604612022969
VITJ34	3/4" - 19 mm	12	5604612022976
VITJ1	1" - 25 mm	12	5604612028657
VITJ112	1 1/2" - 37,5 mm	12	5604612016760
VITJ2	2" - 50 mm	12	5604612016784
VITJ212	2 1/2" - 62,5 mm	12	5604612016777
VITJ3	3" - 75 mm	12	5604612016791
VITJ4	4" - 100 mm	12	5604612016807
VITJ5	5" - 125 mm	12	5604612086961



Pincel redondo › Round brush
Brocha redonda › Pinceau à rechampir

Ref.	Dim.	☐	Ean
VIPR2	2	12	5604612087302
VIPR4	4	12	5604612087319
VIPR6	6	12	5604612016692
VIPR8	8	12	5604612022952
VIPR10	10	12	5604612016708
VIPR12	12	12	5604612022945
VIPR14	14	12	5604612016715
VIPR16	16	12	5604612022938
VIPR18	18	12	5604612016722
VIPR20	20	12	5604612087326
VIPR22	22	12	5604612016739
VIPR24	24	12	5604612087333
VIPR26	26	12	5604612016746
VIPR28	28	12	5604612087340
VIPR30	30	12	5604612016753



Pincel de caiar rectangular

Brocha rectangular

Rectangular whitewash brush

Brosse à chaux rectangulaire



Ref.		Ean
VIREC	12	5604612005566

Pincel de caiar redondo

Brocha redondo

Round whitewash brush

Brosse à chaux ronde



Ref.		Ean
VIRED	16	5604612005573

Pincel de caiar rectangular cabo direito

Brocha rectangular mango recto

Rectangular white wash brush straight handle

Brosse à chaux rectangulaire manche droit



Ref.		Ean
VIRECD	16	5604612619961

Pincel de caiar redondo cabo direito

Brocha redondo mango recto

Round whitewash brush straight handle

Brosse à chaux ronde manche droit



Ref.		Ean
VIREDCD	20	5604612621476

Conjunto de pintura › Painting set

Juego de pintura › Jeu de peinture

› Trincha, rolo e Tabuleiro › Wall brush, roller and tray
› Paletina, rodillo y bandeja › Pinceau plat, rouleau et bac



Ref.		Ean
VICP3P	12	5604612016975

Balde de pintura com grelha

Cubo de pintura con rejilla

Paint bucket with grid

Seau de peinture avec grille



Ref.	Cap.		Ean
VIBPG16	16 L	4	5604612115661

Tabuleiro pintura mini

Mini bandeja pintura

Mini painting tray

Mini peinture bac



Ref.		Ean
VITPM	20	5604612670979

Tabuleiro de pintura sem armação

Bandeja de pintura sin armazón

Tray without frame

Banc à peinture sans poignée



Ref.		Ean
VITBSA	20	5604612016982

Armação para tabuleiro de pintura

Armazón para bandeja de pintura

Handle paint tray

Poignée pour bac de peinture



Ref.		Ean
VIASA	6	5604612037161



Cobertura fácil

Plástico para cobertura
Easy cover

Film de masquage polyéthylène



Ref.	Dim.		Ean
VICF55035	35 m x 55 cm	36	5604612128661

Cobertura fácil

Plástico para cobertura
Easy cover

Film de masquage polyéthylène



Ref.	Dim.		Ean
VICF140035	35 m x 140 cm	36	5604612128678

Cobertura cobre tudo

Cobertura cobre tudo
PE tarpaulin

Bache de couverture



Ref.	Dim.		Ean	Ean
VICCT54	5 x 4 m	40	5604612658717	

Luva de latex natural

Guante de látex natural
Natural latex glove

Gant de latex naturel



Ref.	Pack		Ean
VILL10	10 un.	6	5604612176440
VILL50	50 un.	20	5604612036959

Fato descartável multiusos

Buzo descartable multiusos
Disposable multipurpose coverall
Combinaison jetable multi-usage

› 100 % polipropileno



Ref.	Dim.		Ean
VIFDL	L	30	5604612640132

Canalização

Plomeria

Plumbing

Plomberie



Conjunto de 7 tarrachas para picheleiro

Conjunto de 7 tarrajas de plomero

Set of 7 ratchets die socket

Jeu de 7 filieres en acier

3/8"

1/2"

3/4"

1"

1 1/4"



› Aço temperado › Acero templado › Hardened steel › Acier trempé

Ref.	Ean
VITAPE7	4 5604612672270

Conjunto de 9 tarrachas para picheiro

Juego de 9 tarrajas de plomero

Set of 9 ratchets die socket

Jeu de 9 filieres en acier

- 3/8"
- 1/2"
- 3/4"
- 1"
- 1 1/2"
- 1 1/4"
- 2"



› Aço temperado › Acero templado › Hardened steel › Acier trempé

Ref.	∅	Ean
VITAPE	2	5604612639945

Corta tubos › Pipe cutter

Corta tubos › Ciseaux coupe-tube



Ref.	∅	Ean
VICT332	42 mm	5604612683306

Corta tubos › Pipe cutter

Corta tubos › Ciseaux coupe-tube

- › Aço temperado
- › Acero templado
- › Hardened steel
- › Acier trempé



Ref.	∅	Ean
VICT42	42 mm	5604612027766

Tarraxa em aço para tubo pvc

Tarraja de acero para tubo pvc

Steel ratchet for pvc

Filiere en acier pour tuyau en pvc



Ref.	∅	Ean
VITA12	1/2" - 13 mm	5604612034429
VITA34	3/4" - 19 mm	5604612034436
VITA1	1" - 25 mm	5604612034399

Guia de limpeza

Guia de limpeza

Cleaning tape

Déboucheur à manivelle crampon



› Aço temperado › Acero templado › Hardened steel › Acier trempé

Ref.	∅	Dim.	Ean
VIGL3	6 mm	3 m	5604612028350
VIGL5	9 mm	5 m	5604612028367
VIGL10	9 mm	10 m	5604612028374

Rodízios para corta tubos

Cuchillas de rueda para cortatubos

Blades for pipe cutter

Jeu 2 roulettes pour coupe-tubes



Ref.	Ean
VIRCT332	5604612683689

Lâmina para corta tubos

Cuchilla para corta tubos

Blade for pipe cutter

Lame pour ciseaux coupe-tube

- › Aço temperado
- › Acero templado
- › Hardened steel
- › Acier trempé



Ref.	Ean
VILCT42	5604612027797



Maçarico com patilha
 Quemador de gas con gatillo
Heating torch with lever
 Chalumeau avec levier



Ref.	Ø	kW	g/h	☐	Ean
VIMPD30	30 mm	11,5 kW	820 g/h	20	5604612676285
VIMPD50	50 mm	38 kW	2715 g/h	20	5604612676292
VIMPD76	76 mm	74 kW	188 g/h	20	5604612676308

Maçarico com isqueiro
 Soplete con encendedor
Blow torch with electric ignition
 Lampe à souder avec allumeur



Ref.	☐	Ean
VIMCI	12	5604612648893

Maçarico sem isqueiro
 Soplete sin encendedor
Blow torch traditional ignition
 Lampe à souder sans allumeur



Ref.	☐	Ean
VIMSI	12	5604612648886

Cartucho de gás com válvula de segurança

Cartucho de gas con válvula de seguridad
Gas cartridge with safety valve
 Cartouche de gaz avec valvule de sécurité



Ref.	☐	Ean
VICG190	36	5604612651657

Soldadura
Soldadura
Welding
Soudure

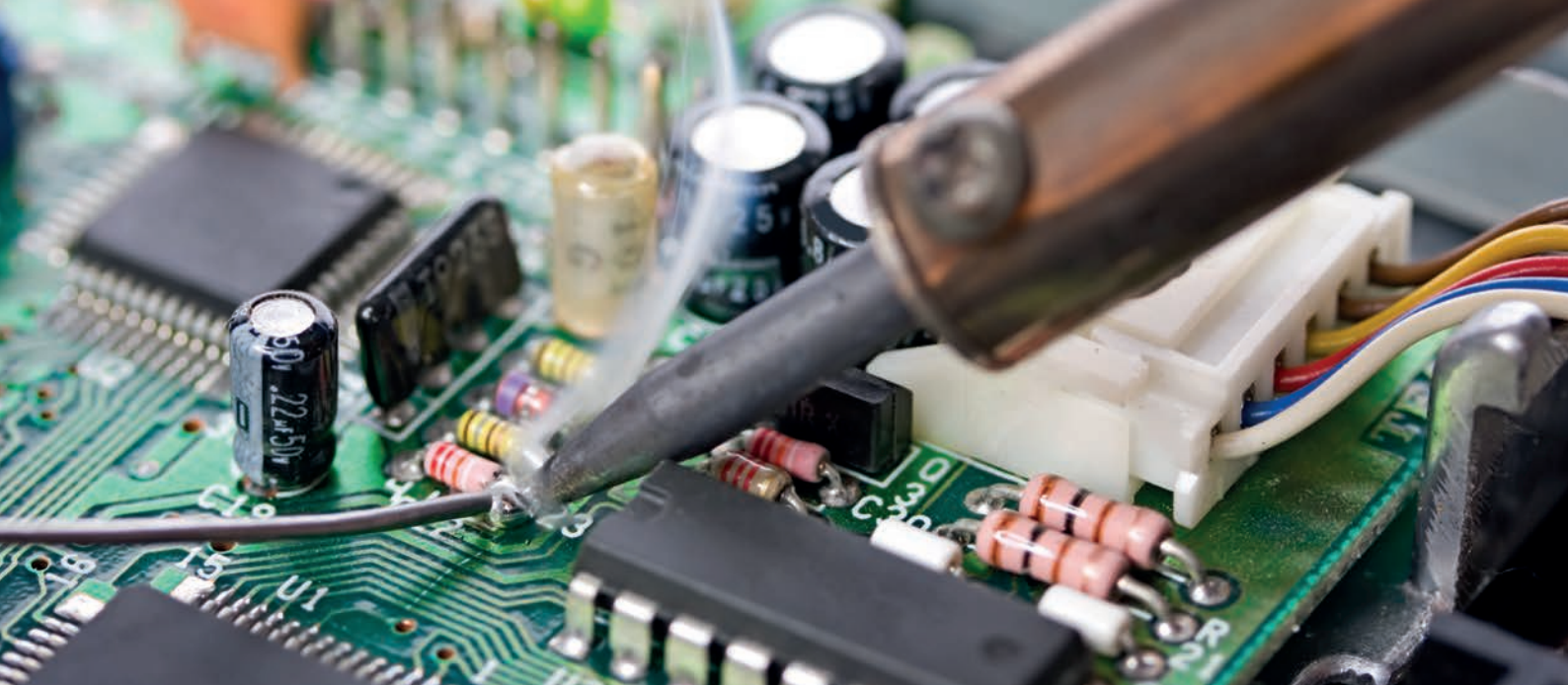

Pistola de soldar › Welding gun
Pistola de soldar › Pistolet à souder

150 W



Ref.	W	📦	Ean
VIPS150	150 W	6	5604612651206

Alicate porta elérodos › Electric welding clamp
Alicate porta electrodos › Pince à souder



Ref.	A	📦	Ean
VIAPE500	500 A	50	5604612677619

Fio de soldar › Welding wire
Hilo de soldar › Fil à souder



Ref.	Ø	📦	Ean
VIFS1	1 mm	50	5604612644604
VIFS2	2 mm	50	5604612644611

Ferro de soldar ponta fina
Soldador universal ponta fina
Soldering iron with fine tip
Fer à souder pointe fine



Ref.	W	📦	Ean
VIFS40	40 W	25	5604612644697
VIFS60	60 W	25	5604612644703

Ferro de soldar ponta curva plana
Soldador universal ponta curva plana
Soldering iron with plain curved tip
Fer à souder pointe courbe plate



Ref.	W	📦	Ean
VIFS80	80 W	25	5604612644710
VIFS100	100 W	25	5604612644673

Alicate massa › Alicate massa
Earth clamp › Pince de masse

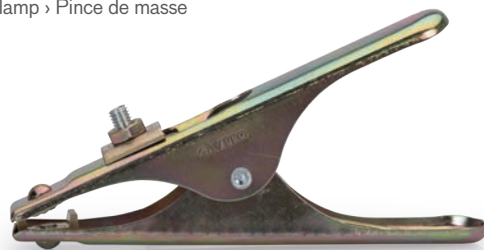

Ref.	A	📦	Ean
VIAM500A	500 A	50	5604612677626

Seringa de sucção › suction syringe
Seringa de succión › seringue de suction



Ref.	📦	Ean
VISS	12	5604612663254

Arrumação
Almacenaje
Storage
Rangement



Porta-paletes › Hand pallet truck

Transpaleta › Transpalette

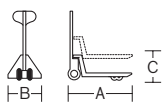

Ref.	A x B	C		Ean
VIPP25	110 x 55 cm	8,5-20 cm	1	5604612016258

Carro de armazém com bscula

Carretilla con bscula

Foldable base hand trolley

Diable de manutention  pelle rabattable

Mx 250 KG

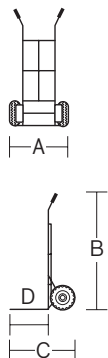

Ref.	A x B x C	D		Ean
VICA10	60 x 125 x 80 cm	60 cm	1	5604612653262

Carro de transporte para botija de gs

Coche de transporte para botija de gas

Handcart (gas bottle)

Chariot pour bouteille de gaz

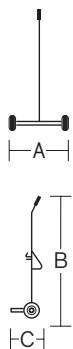

Ref.	A x B x C		Ean
VICA11	50 x 110 x 35 cm	1	5604612007768

Carro de armazém sem bscula

Carretilla sin bscula

Hand trolley

Diable de manutention  pelle fixe

Mx 200 KG

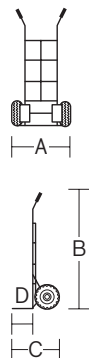

Ref.	A x B x C	D		Ean
VICA7	55 x 115 x 45 cm	20 cm	1	5604612653255

Roda pneumtica para carro armazém sem bscula

Rueda neumtica para carretilla sin bscula

Pneumatic wheel for fixed base hand trolley

Roue pneum. pour diable de manutention  pelle fixe



Ref.		Ean
VIROD5	1	5604612679064

Roda pneumtica para carro armazém com bscula

Rueda neumtica para carretilla con bscula

Pneumatic wheel for foldable hand trolley

Roue pneum. pour diable de manutention  pelle rabattable



Ref.		Ean
VIROD4	1	5604612679057





Carro para ferramentas com 6 gavetas

Carro para herramientas con 6 cajones

Tool roller cabinet with 6 drawers

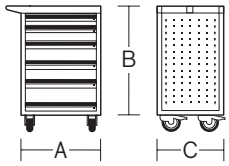
Servante d'atelier avec 6 tiroirs



Ref.	Dim.		Ean
VITF6G	103 x 76 x 46 cm	1	5604612684877



Mala metálica para ferramentas - 3 compartimentos

Caja metálica para herramientas - 3 compartimentos

Tool box - 3 compartments

Boîte à outils - 3 compartiments



Ref.	Dim.		Ean
VIMF3310	310 x 120 x 160 mm	1	5604612005412
VIMF3380	380 x 160 x 200 mm	1	5604612036393
VIMF3420	420 x 160 x 200 mm	1	5604612005429
VIMF3465	465 x 160 x 200 mm	1	5604612036386
VIMF3530	530 x 160 x 200 mm	1	5604612005436

Mala metálica para ferramentas - 5 compartimentos

Caja metálica para herramientas - 5 compartimentos

Tool box - 5 compartments

Boîte à outils - 5 compartiments



Ref.	Dim.		Ean
VIMF5310	310 x 160 x 160 mm	1	5604612005443
VIMF5420	420 x 200 x 200 mm	1	5604612005450
VIMF5465	465 x 200 x 200 mm	1	5604612036379
VIMF5530	530 x 200 x 200 mm	1	5604612005467

Mala para ferramentas › Tool box

Caja para herramientas › Boîte à outils



Ref.	Dim.	📦	Ean
VIM13	13" - 320 x 165 x 136 mm	6	5604612018115
VIM16	16" - 410 x 209 x 195 mm	6	5604612018122

Mala para ferramentas fechos metálicos

Caja para herramientas cierres metalicos

Tool box metal lock

Boite à outils fermetures métalliques



Ref.	Dim.	📦	Ean
VIM20M	20" - 500 x 290 x 250 mm	6	5604612685621

Mala para ferramentas tipo trolei

Caja para herramientas tipo trolley

Tool box trolley

Roulante de chantier



Ref.	Dim.	📦	Ean
VIM25A	25" - 595 x 380 x 420 mm	2	5604612682415

Mala para ferramentas › Tool box

Caja para herramientas › Boîte à outils



Ref.	Dim.	📦	Ean
VIM18	18" - 432 x 250 x 238 mm	6	5604612642242
VIM21	21" - 535 x 291 x 280 mm	6	5604612642259

Mala para ferramentas fechos metálicos

Caja para herramientas cierres metalicos

Tool box metal lock

Boite à outils fermetures métalliques



Ref.	Dim.	📦	Ean
VIM22M	22" - 560 x 300 x 275 mm	6	5604612682408

Mala para ferramentas com organizador

Caja para herramientas con organizador

Tool box with organizer

Boite à outils avec organisateur



Ref.	Dim.	📦	Ean
VIMO17	17" - 420 x 240 x 240 mm	1	5604612676483



Caixa stock › Stock box

Caja de stock › Bac à bec plastique

Ref.	Dim.		Ean
VICSC15	195 x 125 x 96 mm	60	5604612653842
VICSC25	290 x 120 x 165 mm	30	5604612653859
VICSC35	400 x 165 x 215 mm	20	5604612653866
VICSC40	490 x 310 x 195 mm	12	5604612653873



Conjunto 8 caixas stock com fixação de parede

Juego 8 cajas stock con fijación de pared

Set of 8 stock boxes with wall fixing units

Jeu 8 bacs à bec avec panneau mural



Ref.	Dim.		Ean
VICSF8	103 x 165 x 75 mm	12	5604612666842

Caixa de arrumação multiusos

Caja de almacenamiento multiusos

Multipurpose organizer

Boîte de rangement multifonctions



Ref.	Dim.		Ean
VIC7	140 x 195 x 32 mm	36	5604612650490
VIC10	200 x 250 x 42 mm	24	5604612650506

Caixa de arrumação multiusos

Caja de almacenamiento multiusos

Multipurpose organizer

Boîte de rangement multifonctions



Ref.	Dim.		Ean
VIC13	260 x 325 x 48 mm	12	5604612650513
VIC18	305 x 420 x 60 mm	12	5604612650520



Mala de nylon para ferramentas

Mala de nylon para herramientas

Nylon tool pouch

Sac en nylon pour outillage



Ref.		Ean
VIMNF	2	5604612658939

Bolsa de nylon para ferramentas

Bolsa de nylon para herramientas

Nylon tool pouch

Ceinture porte-outils en nylon



Ref.		Ean
VIBN1	20	5604612635909

Bolsa dupla de nylon para ferramentas

Bolsa doble de nylon para herramientas

Nylon double tool pouch

Ceinture porte-outils double en nylon



Ref.		Ean
VIBN2	10	5604612635916



Mochila de trabalho

Mochila de trabajo

Work backPack

Sac à dos de travail



Ref.	Ean
VIMOV	5604612682187

Bolsa em couro para ferramentas

Bolsa de cuero para herramientas

Leather tool pouch

Cartouchière à outils en cuir



Ref.	Ean
VIBC1	5604612008222

Bolsa dupla em couro para ferramentas

Bolsa de cuero doble para herramientas

Double tool pouch leather

Cartouchière à outils double en cuir



Ref.	Ean
VIBC2	5604612012137

Escadas
Escaleras
Ladders
Échelles



Escada Electra tripla
Escalera electra tripla
Triple ladder Electra
Échelle triple Electra

Alumínio › Aluminum
Aluminio › Aluminium

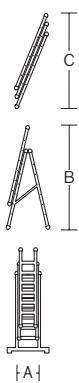

Ref.	Dimensions	A	B	C	Weight (kg)	Quantity	Ean
VIEE3X3	3 x 10 m	0,46 m	5 m	6,92 m	19 kg	1	5604620800306

Escada Electra dupla
Escalera doble Electra
Double ladder Electra
Échelle double Electra

Alumínio › Aluminum
Aluminio › Aluminium

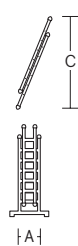

Ref.	Dimensions	A	B	C	Weight (kg)	Quantity	Ean
VIEE2X3	2 x 10 m	0,40 m	-	5 m	15 kg	1	5604620803000

**Escada eco simples
degrau redondo**

Escalera eco simples
peldaño redondo
Round steps ladder
Échelle eco simple
échelons ronds

Alumínio › Aluminum
Aluminio › Aluminium



Ref.	Step	A	B	C	KG	Box	Ean
VIESR2	6	0,36 m	2 m	-	3 kg	1	5604612643461
VIESR25	8	0,36 m	2,6 m	-	4 kg	1	5604612643492
VIESR3	9	0,36 m	3,0 m	-	5 kg	1	5604612643478
VIESR35	11	0,51 m	3,5 m	-	6 kg	1	5604612643508
VIESR4	12	0,51 m	4,0 m	-	6 kg	1	5604612643485
VIESR5	16	0,51 m	5,0 m	-	8 kg	1	5604612136185
VIESR6	19	0,51 m	6,0 m	-	9 kg	1	5604612136192

**Escada simples
degrau quadrado**

Escalera simples
peldaño cuadrado
Square steps ladder
Échelle simple
échelons carrés

Alumínio › Aluminum
Aluminio › Aluminium



Ref.	Step	A	B	C	KG	Box	Ean
VIESQ2	7	0,35 m	2,0 m	-	3,6 kg	1	5604612136116
VIESQ25	9	0,35 m	2,5 m	-	4,5 kg	1	5604612136123
VIESQ3	10	0,35 m	3,0 m	-	5,0 kg	1	5604612136130
VIESQ35	12	0,35 m	3,3 m	-	6,8 kg	1	5604612136147
VIESQ4	14	0,35 m	4,0 m	-	7,8 kg	1	5604612136154
VIESQ5	17	0,35 m	5,0 m	-	9,3 kg	1	5604612136161
VIESQ6	21	0,35 m	6,0 m	-	11,2 kg	1	5604612136178

**Escada eco dupla
degrau redondo**Escalera eco dupla
peldaño redondo**Round steps
double ladder**Échelle eco double
échelons rondsAlumínio > Aluminum
Aluminio > Aluminium

Ref.	Step	A	B	C	KG	Box	Ean
VIEDR2	2 x 6	0,6 m	2 m	3,3 m	7 kg	1	5604612019525
VIEDR25	2 x 8	0,6 m	2,5 m	4,4 m	9 kg	1	5604612643539
VIEDR3	2 x 9	0,6 m	2,9 m	5 m	10 kg	1	5604612017781
VIEDR35	2 x 11	0,6 m	3,3 m	5,8 m	12 kg	1	5604612136352
VIEDR4	2 x 12	0,6 m	3,9 m	6,6 m	14 kg	1	5604612136369
VIEDR5	2 x 16	0,6 m	4,5 m	7,6 m	17 kg	1	5604612136376
VIEDR6	2 x 19	0,6 m	5,6 m	9,2 m	20 kg	1	5604612136383

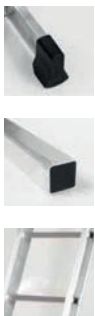
**Escada dupla
degrau quadrado**Escalera dupla
peldaño cuadrado**Square steps
double ladder**Échelle double
échelons carrésAlumínio > Aluminum
Aluminio > Aluminium

Ref.	Step	A	B	C	KG	Box	Ean
VIEDQ2	2 x 7	0,40 m	2,0 m	3,3 m	8,5 kg	1	5604612643515
VIEDQ25	2 x 9	0,40 m	2,5 m	4,4 m	10,5 kg	1	5604612136291
VIEDQ3	2 x 10	0,40 m	2,9 m	5,0 m	11,7 kg	1	5604612136307
VIEDQ35	2 x 12	0,40 m	3,3 m	5,8 m	14 kg	1	5604612136314
VIEDQ4	2 x 14	0,40 m	4 m	6,6 m	15,9 kg	1	5604612136321
VIEDQ5	2 x 17	0,40 m	4,8 m	8,3 m	20,4 kg	1	5604612136338
VIEDQ6	2 x 21	0,40 m	5,8 m	10,4 m	27,3 kg	1	5604612136345

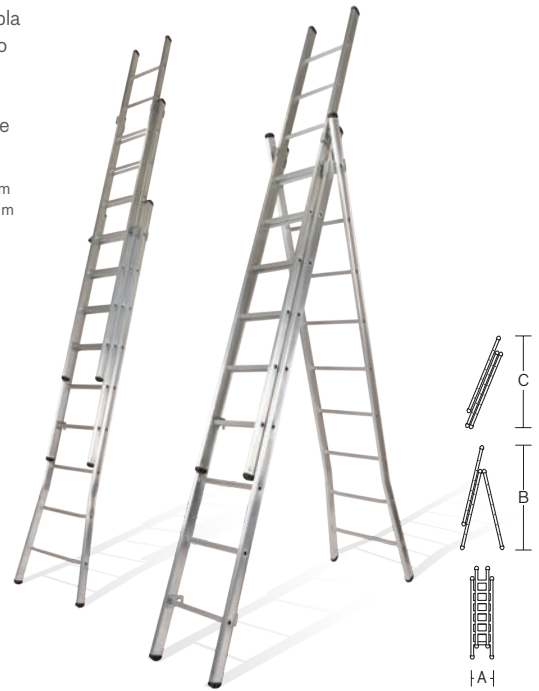
**Escada eco tripla
degrau redondo**Escalera eco tripla
peldaño redondo**Round steps
triple ladder**Échelle eco triple
échelons rondsAlumínio > Aluminum
Aluminio > Aluminium

Ref.	Step	A	B	C	KG	Box	Ean
VIETR2	3 x 6	0,6 m	3,3 m	4,4 m	11 kg	1	5604612136246
VIETR25	3 x 8	0,6 m	4,4 m	5,6 m	14 kg	1	5604612136253
VIETR3	3 x 9	0,6 m	5,0 m	6,5 m	16 kg	1	5604612643522
VIETR35	3 x 11	0,6 m	5,8 m	7,5 m	19 kg	1	5604612102364
VIETR4	3 x 12	0,6 m	7,10 m	8,6 m	23 kg	1	5604612136260
VIETR5	3 x 16	0,6 m	8,5 m	10,7 m	28 kg	1	5604612136277
VIETR6	3 x 19	0,6 m	10,7 m	13,7 m	33 kg	1	5604612136284

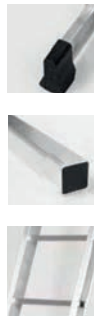
**Escada tripla
degrau quadrado**Escalera tripla
peldaños cuadrados**Square steps
triple ladder**Échelle triple
échelons carrésAlumínio > Aluminum
Aluminio > Aluminium

Ref.	Step	A	B	C	KG	Box	Ean
VIETQ2	3 x 7	0,5 m	3,3 m	4,7 m	12,4 kg	1	5604612109264
VIETQ25	3 x 9	0,5 m	4,4 m	6,0 m	15,3 kg	1	5604612136208
VIETQ3	3 x 10	0,5 m	5,0 m	6,9 m	17,2 kg	1	5604612136215
VIETQ35	3 x 12	0,5 m	5,8 m	8,0 m	21,6 kg	1	5604612643546
VIETQ4	3 x 14	0,5 m	6,7 m	9,3 m	24,7 kg	1	5604612136222
VIETQ5	3 x 17	0,5 m	8,3 m	11,8 m	33,2 kg	1	5604612136239
VIETQ6	3 x 21	0,5 m	10,4 m	15,0 m	42,8 kg	1	5604612153359

Andaime multissos

Andamio multissos

Multipurpose scaffold

Échafaudage multi-usage

Alumínio › Aluminum
Aluminio › Aluminium



Ref.	↙	A	B	KG	📦	Ean
VIAM	10	-	1,6 m	12,5 kg	1	5604612689520

Escada multifunções

Escalera multifunciones

Multifunction ladder

Échelle multifonctions

Metal › Metal
Metal › Métal



Ref.	↙	A	B	KG	📦	Ean
VIEMF	16	0,5 m	1,9 m	20 kg	1	5604612643287

Escadote em alumínio profissional

Escalera profesional en aluminio

Professional aluminium stepladder

Escabeau professionnel en aluminium

Alumínio › Aluminum
Aluminio › Aluminium



Ref.	↙	A	B	KG	📦	Ean
VIEA5P	5	0,4 m	1,3 m	6,0 kg	1	5604612689537
VIEA6P	6	0,5 m	1,5 m	10 kg	1	5604612689544
VIEA7P	7	0,5 m	2,2 m	12,7 kg	1	5604612689551
VIEA8P	8	0,6 m	2,4 m	12,7 kg	1	5604612689568

Escada multissos

Escalera multissos

Multi-purpose ladder

Échelle multifonctions

Alumínio › Aluminum
Aluminio › Aluminium



Ref.	↙	A	B	KG	📦	Ean
VIEM36	12	0,3 m	3,6 m	12 kg	1	5604612172886
VIEM47	16	0,3 m	4,7 m	14 kg	1	5604612139711

Escadote alumínio plus

Escalera en aluminio plus
Aluminium stepladder plus
 Escabeau en aluminium plus

Alumínio › Aluminium
 Aluminio › Aluminium



Ref.	A	B	KG	Ean		
VIEAP3	3	0,5 m	1,6 m	3,9 kg	1	5604612668433
VIEAP4	4	0,5 m	1,5 m	4,7 kg	1	5604612668440
VIEAP5	5	0,5 m	1,7 m	5,5 kg	1	5604612668457
VIEAP6	6	0,5 m	2,0 m	6,5 kg	1	5604612668464
VIEAP7	7	0,6 m	2,2 m	7,4 kg	1	5604612668471
VIEAP8	8	0,6 m	2,5 m	8,4 kg	1	5604612668488

Escadote duplo

Escalera doble
Double aluminium stepladder
 Escabeau double

Alumínio › Aluminium
 Aluminio › Aluminium



Ref.	A	B	KG	Ean		
VIEAD3	3	0,4 m	0,7 m	3,0 kg	1	5604612613198
VIEAD4	4	0,4 m	0,9 m	4,0 kg	1	5604612613204
VIEAD5	5	0,5 m	1,1 m	5,0 kg	1	5604612613211
VIEAD6	6	0,5 m	1,4 m	6,0 kg	1	5604612613228

Escadote de alumínio

Escalera en aluminio
Aluminium stepladder
 Escabeau en aluminium

Alumínio › Aluminium
 Aluminio › Aluminium

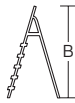

Ref.	A	B	KG	Ean		
VIEAC2	2	0,4 m	1,0 m	2,3 kg	1	5604620024221
VIEAC3	3	0,4 m	1,2 m	2,8 kg	1	5604612668372
VIEAC4	4	0,4 m	1,5 m	3,4 kg	1	5604612668389
VIEAC5	5	0,5 m	1,7 m	4,0 kg	1	5604612668396
VIEAC6	6	0,5 m	1,9 m	4,8 kg	1	5604612668402
VIEAC7	7	0,5 m	2,1 m	5,7 kg	1	5604612668419
VIEAC8	8	0,5 m	2,4 m	6,4 kg	1	5604612668426

Banco escadote

Tamborete de escalera
Step tool
 Marche pied

Metal › Metal
 Metal › Métal



Ref.	A	B	KG	Ean		
VIBEM	2	0,5 m	0,9 m	5,0 kg	1	5604612643355

Escadote metálico

Escalera metálica
Metalic stepladder
 Escabeau en fer

Alumínio › Aluminium
 Aluminio › Aluminium



Ref.	A	B	KG	Ean		
VIEME3	3	0,5 m	1,3 m	3,9 kg	2	5604612643294
VIEME4	4	0,5 m	1,5 m	4,7 kg	2	5604612643300
VIEME5	5	0,5 m	1,7 m	5,5 kg	2	5604612643317
VIEME6	6	0,5 m	2,0 m	6,5 kg	2	5604612643324
VIEME7	7	0,6 m	2,2 m	7,4 kg	2	5604612643331
VIEME8	8	0,6 m	2,5 m	8,4 kg	2	5604612643348

Escadotim metálico

Tamborete de escalera
Step ladder
 Escabeau métallique

Metal › Metal
 Metal › Métal



Ref.	A	B	KG	Ean		
VIEM2	2	0,5 m	0,9 m	5,0 kg	2	5604612643362
VIEM3	3	0,5 m	1,1 m	6,5 kg	2	5604612643379
VIEM4	4	0,5 m	1,4 m	8,5 kg	2	5604612643386

Ferragens e utilidades

Ferreteria
y utensilios

**Tools and
utilities**

Outils et
utilitaires



Corrente electro soldada zincada - rolo

Cadena electrosoldada galvanizada - rollo

Welded link chain - roll

Chaîne soudée zinguée - rouleau



Ref.	⊖	/KG	Ean
VICZ18	1/8 "	25 kg	5604612121136
VICZ532	5/32 "	25 kg	5604612121174
VICZ316	3/16 "	50 kg	5604612121143
VICZ14	1/4 "	50 kg	5604612121129
VICZ516	5/16 "	50 kg	5604612121167
VICZ38	3/8 "	50 kg	5604612121150
VICZ716	7/16 "	50 kg	5604612121198
VICZ12	1/2 "	50 kg	5604612121112

Corrente electro soldada zincada - rolo

Cadena electrosoldada galvanizada - rollo

Welded link chain - roll

Chaîne soudée zinguée - rouleau



Ref.	⊖	/KG	Ean
VICZ2N	2 mm	20 kg	5604612037857
VICZ2,5N	2,5 mm	20 kg	5604612037864
VICZ3N	3 mm	20 kg	5604612037871
VICZ4N	4 mm	20 kg	5604612037888
VICZ5N	5 mm	20 kg	5604612037895
VICZ6N	6 mm	20 kg	5604612037901
VICZ7N	7 mm	20 kg	5604612102951
VICZ8N	8 mm	20 kg	5604612037918
VICZ9N	9 mm	20 kg	5604612037925
VICZ10N	10 mm	20 kg	5604612037932
VICZ11N	11 mm	20 kg	5604612037949
VICZ13N	13 mm	20 kg	5604612037956

Garibaldi Polipasto Chain block Palan à chaînes



Ref.	CAP.	⊞	Ean
VIG1	1 T	1	5604612007287
VIG12	1/2 T	1	5604612007072
VIG112	1,1/2 T	1	5604612007294
VIG2	2 T	1	5604612007300





Esticador em aço › Steel hand puller
Tractel horizontal en acero › Treuil en acier

Máx.: ø 4,5 mm



Ref.	CAP.		Ean
VIE2T	2 ton	8	5604612006877

Cabo de aço revestido - rolo de 250 m

Cable en acero revestido - rollo de 250 m

Coated galvanized wire rope - 250 m roll

Câble en acier gainé - rouleau de 250 m

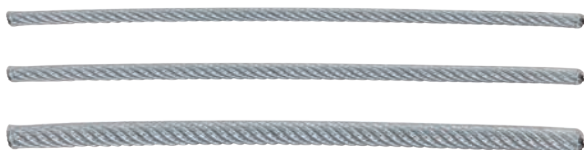

Ref.	⊖	Ean
VICAR3MM	3 mm	5604612037963
VICAR4MM	4 mm	5604612626785
VICAR5MM	5 mm	5604612626792

Cabo de aço galvanizado - rolo de 100 m

Cable acero galvanizado - rollo de 100 m

Galvanized wire rope - 100 mroll

Câble en acier galvanisé - rouleau 100 m



Ref.	⊖	kg	Ean
VICAG3	3 mm	3,3 kg	5604612136574
VICAG4	4 mm	5,7 kg	5604612136581
VICAG5	5 mm	8,9 kg	5604612136598
VICAG6	6 mm	12,5 kg	5604612136604
VICAG8	8 mm	22 kg	5604612136628
VICAG10	10 mm	35 kg	5604612136642
VICAG12	12 mm	48 kg	5604612136659

Rede crivo de aço - rolo de 25 m

Red criba de acero - rollo de 25 m

Galvanized iron wire netting - 25 m roll

Toile de criblage en acier - rouleau de 25 m



Ref.	□	Dim.	Ean
VIRAC1616	1,6 x 1,6 mm	00 cm	5604612122430
VIRAC2222	2,2 x 2,2 mm	00 cm	5604612122447
VIRAC234	2,3 x 4 mm	00 cm	5604612122416
VIRAC2412	2,4 x 1,2 mm	00 cm	5604612122423

Rede fibra de vidro - rolo de 50 m

Red fibra vidrio - rollo de 50 m

Coated glass fiber mesh - 50 m roll

Grillage fibre de verre - rouleau 50 m

120 g/m²

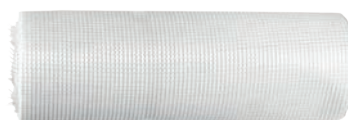

Ref.	Dim.	Ean
VIRFV40	40 cm	5604612102722
VIRFV100	100 cm	5604612102715

Corda em polietileno - rolo

Cuerda polietileno - rollo

Polyethylene rope - roll

Corde en polyéthylène - rouleau

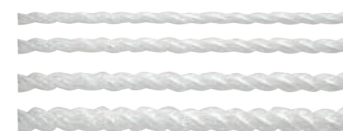

Ref.	⊖	Dim.		Ean
VICN4	4 mm	± 617 m	5	5604612105778
VICN5	5 mm	± 400 m	5	5604612105822
VICN6	6 mm	± 277 m	5	5604612105839
VICN8	8 mm	± 623 m	20	5604612105846
VICN10	10 mm	± 399 m	20	5604612105785
VICN12	12 mm	± 277 m	20	5604612105792
VICN14	14 mm	± 254 m	25	5604612105808
VICN16	16 mm	± 195 m	25	5604612105815
VICN20	20 mm	± 150 m	30	5604612627010



**Roldana plástica
com gancho**

Polea plástica
con gancho

**Plastic pulley
with hook**

Poulie plastique
avec crochet



Ref.	Dim.	📦	Ean
VIRPG4	4 cm	9	5604612013677
VIRPG6	6 cm	9	5604612013684

Roldana › Pulley

Polea › Poulie à crochet



Ref.	Dim.	📦	Ean
VIR8	8 cm	20	5604612013585
VIR10	10 cm	20	5604612009014
VIR12	12 cm	10	5604612009021
VIR14	14 cm	10	5604612009038
VIR16	16 cm	10	5604612009045
VIR18	18 cm	10	5604612013639
VIR20	20 cm	10	5604612013646

**Roldana com
parafuso aglomerado**

Polea con tornillo
conglomerado

**Pulley with
conglomerate screw**

Poulie avec
vis agglomérée



Ref.	Nº	📦	Ean
VIRO7	7	25	5604612012915

**Roldana com
parafuso hexagonal**

Polea con tornillo
hexagonal

**Pulley with
hexagonal screw**

Poulie avec
vis hexagonale



Ref.	Nº	📦	Ean
VIRO8	8	25	5604612012922

**Roldana com parafuso
aglomerado com resguardo**

Polea con tornillo
conglomerado y protección

**Pulley with conglomerate
screw and cover**

Poulie avec vis agglomérée
avec cachette



Ref.	Nº	📦	Ean
VIRO9	9	25	5604612033729

**Roldana com parafuso
hexagonal com resguardo**

Polea con tornillo
hexagonal con protección

**Pulley with hexagonal
screw and cover**

Poulie avec vis hexagonale
avec cachette



Ref.	Nº	📦	Ean
VIRO10	10	25	5604612033736

**Roldana plástica
com parafuso**

Polea plástica
con tornillo

**Plastic pulley
with screw**

Poulie plastique
avec vis



Ref.	Nº	📦	Ean
VIRP4	4 cm	50	5604612013653
VIRP6	6 cm	25	5604612013660

Roldana de parede

Polea de pared

Wall pulley

Poulie d'applique verticale



Ref.	Nº	📦	Ean
VIRO6	6	25	5604612012908

Elo de pancada galvanizado

Anillos partidos

Repair link

Maillon galvanisé



Ref.	Dim.		Ean
VEPG4	4 mm	25	5604612618056
VEPG5	5 mm	25	5604612618063
VEPG6	6 mm	25	5604612618070
VEPG8	8 mm	25	5604612618087
VEPG10	10 mm	25	5604612618094
VEPG12	12 mm	25	5604612618100

Destorcedor galvanizado

Rodete galvanizado

Galvanized swivel

Émerillon galvanisé



Ref.	Dim.		Ean
VIDG5	5 mm	25	5604612618216
VIDG6	6 mm	25	5604612618223
VIDG7	7 mm	25	5604612618230
VIDG8	8 mm	25	5604612618247

Esticador galvanizado

Tensor galvanizado

Turnbuckle

Tendeur crochet oeil galvanisé



Ref.	Dim.		Ean
VIEG316	3/16 " - 5 mm	25	560461202159
VIEG14	1/4 " - 6 mm	25	5604612029395
VIEG516	5/16 " - 8 mm	25	5604612029388
VIEG38	3/8 " - 10 mm	25	5604612029128
VIEG12	1/2 " - 12 mm	25	5604612029111

Destorcedor galvanizado duplo

Rodete doble galvanizado

Galvanized double swivel

Double émerillon galvanisé



Ref.	Dim.		Ean
VIDGD6	6 - 66 mm	25	5604612618254
VIDGD8	8 - 94 mm	25	5604612618261
VIDGD10	10 - 118 mm	25	5604612618278
VIDGD13	13 - 152 mm	25	5604612618285
VIDGD16	16 - 188 mm	25	5604612618292
VIDGD19	19 - 229 mm	25	5604612618308

Mosquetão niquelado

Mosquetón niquelado

Nickle-plated snak hook with swivel

Mousqueton simple



Ref.	Dim.		Ean
VIMN40	40 mm	25	5604612120764
VIMN50	50 mm	25	5604612120771
VIMN60	60 mm	25	5604612120788
VIMN70	70 mm	25	5604612120795
VIMN80	80 mm	25	5604612120801
VIMN90	90 mm	25	5604612120818
VIMN100	100 mm	25	5604612120825
VIMN120	120 mm	25	5604612120832

Mosquetão bombeiro galvanizado c/ segurança

Mosquetón bombero galvanizado con tornillo

Snap hook with screw

Mousqueton de sécurité à vis



Ref.	Dim.		Ean
VIMGS40	40 mm	25	5604612618117
VIMGS50	50 mm	25	5604612618124
VIMGS60	60 mm	25	5604612618131
VIMGS70	70 mm	25	5604612618148
VIMGS80	80 mm	25	5604612618155
VIMGS90	90 mm	25	5604612618162
VIMGS100	100 mm	25	5604612618179
VIMGS120	120 mm	25	5604612618186
VIMGS140	140 mm	25	5604612618193
VIMGS160	160 mm	25	5604612618209

Mosquetão bombeiro

Mosquetón bombero

Galvanized snap hook

Mousqueton type pompier



Ref.	Dim.		Ean
VIMB50	50 mm	25	5604612102777
VIMB60	60 mm	25	5604612102784
VIMB70	70 mm	25	5604612102791
VIMB80	80 mm	25	5604612102807
VIMB90	90 mm	25	5604612102814
VIMB100	100 mm	25	5604612102746
VIMB120	120 mm	25	5604612102753
VIMB140	140 mm	25	5604612102760

Elo de engate

Eslabones de unión galvanizado

Quick link

Maillon rapide



Ref.	Dim.		Ean
VIEL3	3 mm	25	5604612120917
VIEL4	4 mm	25	5604612120924
VIEL5	5 mm	25	5604612120931
VIEL6	6 mm	25	5604612120948
VIEL7	7 mm	25	5604612120955
VIEL8	8 mm	25	5604612120962
VIEL10	10 mm	25	5604612120979
VIEL12	12 mm	25	5604612120986

Cerra cabo galvanizado

Sujetacables galvanizados

Wire rope clip

Serre-câble galvanisé



Ref.	Dim.		Ean
VICC18	1/8 " - 3 mm	25	5604612120863
VICC316	3/16 " - 5 mm	25	5604612120870
VICC14	1/4 " - 6 mm	25	5604612120856
VICC516	5/16 " - 8 mm	25	5604612120894
VICC38	3/8 " - 10 mm	25	5604612120887
VICC716	7/16 " - 11 mm	25	5604612120900
VICC12	1/2 " - 12 mm	25	5604612120849

Manilha galvanizada

Manillas rectas con cáncamo

Dee shackle

Manille galvanisée



Ref.	Dim.		Ean
VIMG5	3/16 " - 5 mm	25	5604612617936
VIMG6	1/4 " - 6 mm	25	5604612617943
VIMG8	5/16 " - 8 mm	25	5604612617950
VIMG10	3/8 " - 10 mm	25	5604612617967
VIMG11	7/16 " - 11 mm	25	5604612617974
VIMG12	1/2 " - 12 mm	25	5604612617981
VIMG14	9/16 " - 14 mm	25	5604612617998
VIMG16	5/8 " - 16 mm	25	5604612618001
VIMG18	11/16 " - 18 mm	25	5604612618018
VIMG20	3/4 " - 20 mm	25	5604612618025
VIMG22	7/8 " - 22 mm	25	5604612618032
VIMG25	1 " - 25 mm	25	5604612618049

**Cadeado de alumínio**

Candado de alumínio
Aluminium padlock
Cadenas en aluminium

3x 

Ref.	Dim.		Ean
VIAQA20	20 mm	6	5604612686734
VIAQA25	25 mm	6	5604612686741
VIAQA30	30 mm	6	5604612686758
VIAQA40	40 mm	6	5604612686765
VIAQA50	50 mm	6	5604612686772

Cadeado de alta segurança

Candado alta seguridad
Top security padlock
Cadenas haute sécurité

3x 

Ref.	Dim.		Ean
VIAAS50B	50 mm	6	5604612014230

Cadeado para bagagem

Candado para bagaje
Luggage padlock
Cadenas pour bagage

2x 

Ref.	Dim.		Ean
VIA B	30 mm	6	5604612652869

Cadeado

Candado
Padlock
Cadenas

3x 

Ref.	Dim.		Ean
VIAQ20	20 mm	6	5604612007898
VIAQ25	25 mm	6	5604612007843
VIAQ30	30 mm	6	5604612007867
VIAQ35	35 mm	6	5604612009519
VIAQ40	40 mm	6	5604612007850
VIAQ45	45 mm	6	5604612007874
VIAQ50	50 mm	6	5604612007881
VIAQ60	60 mm	6	5604612009526
VIAQ70	70 mm	6	5604612661007

Cadeado argola alta

Candado arco largo
Long shackle arc padlock
Cadenas à anse longue

3x 

Ref.	Dim.		Ean
VIAA30	30 mm	6	5604612007928
VIAA40	40 mm	6	5604612007904
VIAA50	50 mm	6	5604612007911

Cadeado em "U"

Candado en "U"
"U" type padlock
Cadenas en "U"

3x 

Ref.	Dim.		Ean
VIAQU50	50 mm	6	5604612641931
VIAQU60	60 mm	6	5604612641948
VIAQU75	75 mm	6	5604612641955
VIAQU90	90 mm	6	5604612652784

Cadeado com combinação

Candado con combinación
Combination padlock
Cadenas à combinaison



Ref.	Dim.		Ean
VIA C30	30 mm	6	5604612652791
VIA C40	40 mm	6	5604612652807

Cadeado liga de zinco com combinação

Candado aleación de zinc con combinación
Zinc alloy combination padlock
Cadenas en alliage de zinc à combinaison



Ref.	Dim.		Ean
VIAZC20	20 mm	6	5604612652845
VIAZC30	30 mm	6	5604612652852

Mola de porta vai-vem

Cierra puertas aereo

Door closer

Ferme-porte avec bras à compas

45 kg min.
65 kg máx.

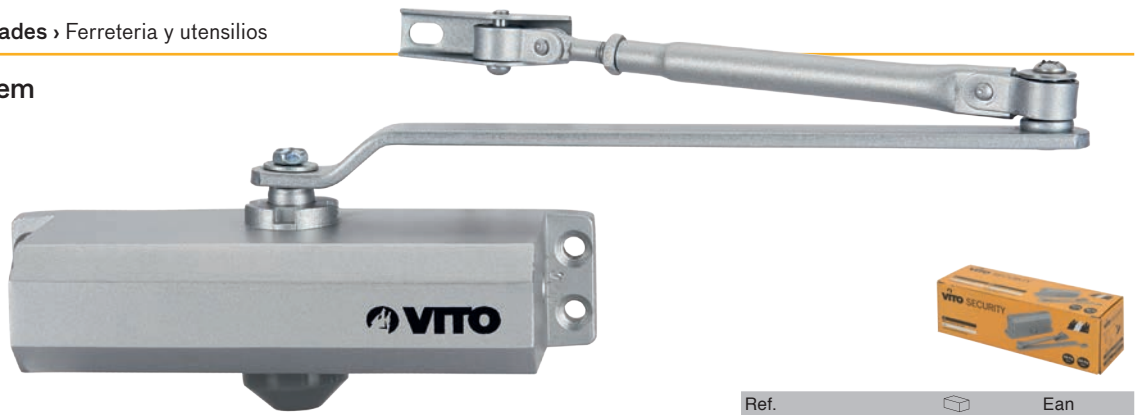

Ref.	Ean
VIMPV	5604612015442

Canhão de segurança

Cilindro de seguridad

Security cylinder

Cylindre de serrure haute sécurité



Ref.	Ean
VICSB	5604612009069

Canhão para fechadura

Cilindro para cerradura

Cylinder for door lock

Cylindre de serrure



Ref.	Ean
VICFP	5604612024611
VICFD	5604612024604

Fechadura com fechos de segurança 9072 direita

Cerradura con cerrojo de seguridad 9072 derecha

Door lock with safety catch 9072 right

Serrure avec 4 points de sécurité 9072 droite

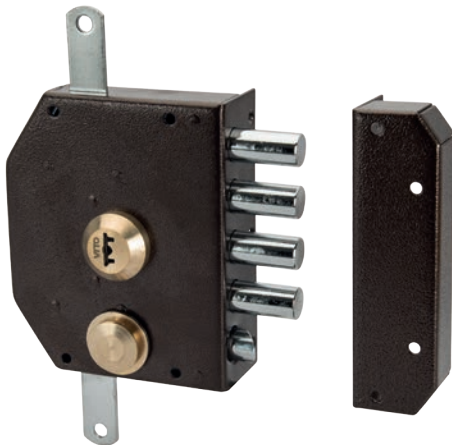

Ref.	Dim.	Ean
VIF9072D	160 mm	5604612035778

Fechadura com fechos de segurança 9072 esquerda

Cerradura con cerrojo de seguridad 9072 izquierda

Door lock with safety catch 9072 left

Serrure avec 4 points de sécurité 9072 gauche

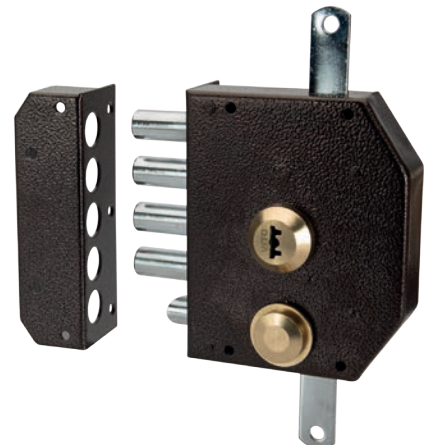

Ref.	Dim.	Ean
VIF9072E	160 mm	5604612035761

Fechadura 720 direita › Door lock 720 right

Cerradura 720 derecha › Serrure à cylindre horizontale tirage 720 droite



Ref.	Dim.	Ean
VIF72010D	100 mm	5604612005061
VIF72012D	120 mm	5604612019549
VIF72014D	140 mm	5604612035785

Fechadura 720 esquerda › Door lock 720 left

Cerradura 720 izquierda › Serrure à cylindre horizontale tirage 720 gauche



Ref.	Dim.	Ean
VIF72010E	100 mm	5604612019532
VIF72012E	120 mm	5604612019556
VIF72014E	140 mm	5604612035792



Prateleira aglomerado laminado
 Anaquel aglomerado laminado
Shelves in agglomerate laminated
 Pánneau agglomeré melaminé

Ref.		A x B x C		Ean
VIPALVM2080	●	80 x 20 x 1,5 cm	6	5604612656737
VIPALVM20100	●	100 x 20 x 1,5 cm	6	5604612656744
VIPALVM3080	●	80 x 30 x 1,5 cm	6	5604612656720
VIPALVM30100	●	100 x 30 x 1,5 cm	6	5604612656713
VIPALPR2080	●	80 x 20 x 1,5 cm	6	5604612656683
VIPALPR20100	●	100 x 20 x 1,5 cm	6	5604612656676
VIPALPR3080	●	80 x 30 x 1,5 cm	6	5604612656690
VIPALPR30100	●	100 x 30 x 1,5 cm	6	5604612656706
VIPALB2080	○	80 x 20 x 1,5 cm	6	5604612654733
VIPALB20100	○	100 x 20 x 1,5 cm	6	5604612656010
VIPALB3080	○	80 x 30 x 1,5 cm	6	5604612653590
VIPALB30100	○	100 x 30 x 1,5 cm	6	5604612653606
VIPALMR2080	●	80 x 20 x 1,5 cm	6	5604612664657
VIPALMR20100	●	100 x 20 x 1,5 cm	6	5604612664626
VIPALMR3080	●	80 x 30 x 1,5 cm	6	5604612664640
VIPALMR30100	●	100 x 30 x 1,5 cm	6	5604612664633
VIPALCS2080	●	80 x 20 x 1,5 cm	6	5604612664602
VIPALCS20100	●	100 x 20 x 1,5 cm	6	5604612664589
VIPALCS3080	●	80 x 30 x 1,5 cm	6	5604612664619
VIPALCS30100	●	100 x 30 x 1,5 cm	6	5604612664596

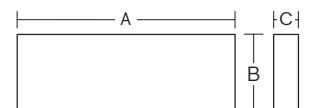
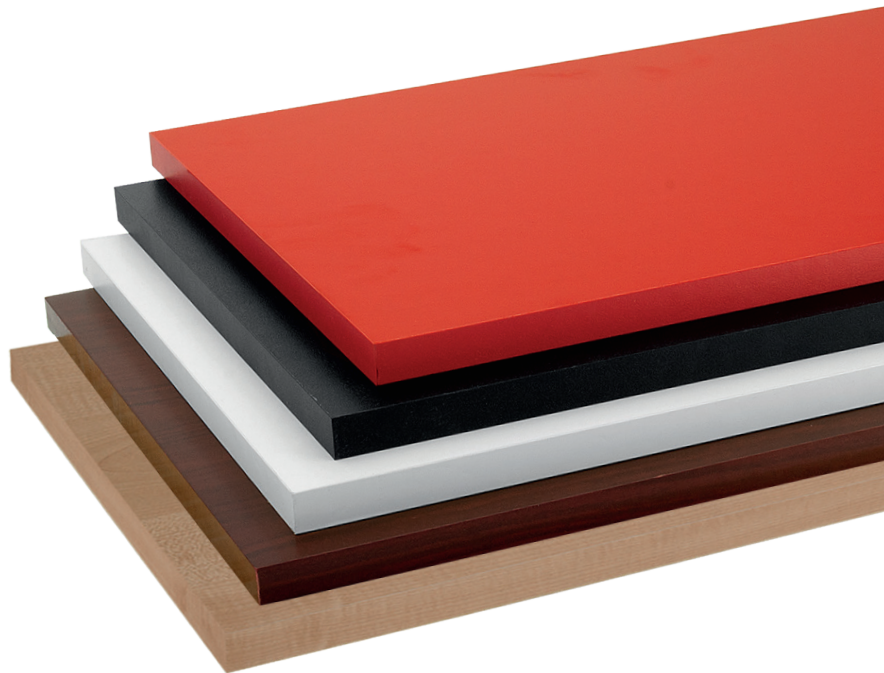

Cantoneira 511

Escuadra 511

Shelf bracket 511

Console pour étagère 511



Ref.	Dim.		Ean
VIC5115	125 x 150 mm	20	5604612014766
VIC5116	150 x 200 mm	20	5604612007164
VIC5118	200 x 250 mm	20	5604612007171
VIC51110	250 x 300 mm	20	5604612007188
VIC51112	300 x 350 mm	20	5604612014759

Cantoneira 511 reforçada

Escuadra 511 reforzada

Shelf bracket strengthened 511

Console pour étagère renforcée 511



Ref.	Dim.		Ean
VICR5115	125 x 150 mm	12	5604612035808
VICR5116	150 x 200 mm	12	5604612035815
VICR5118	200 x 250 mm	12	5604612035822
VICR51110	250 x 300 mm	12	5604612027711
VICR51112	300 x 350 mm	12	5604612035839

Cantoneira 515 reforçada

Escuadra 515 Ref.orzada

Shelf bracket strengthened 515

Console pour étagère renforcée 515



Ref.	Dim.		Ean
VICR51530	300 x 200 mm	10	5604612092092
VICR51540	400 x 270 mm	10	5604612092108
VICR51550	500 x 320 mm	10	5604612092115

Poleia

Cartela

Bracket

Console pour crémaillère

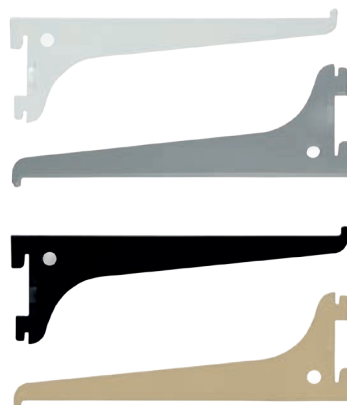

Ref.		Dim.		Ean
VIPT20B	○	200 mm	12	5604612616984
VIPT30B	○	300 mm	12	5604612617028
VIPT20AL	●	200 mm	12	5604612616960
VIPT30AL	●	300 mm	12	5604612617004
VIPT20P	●	200 mm	12	5604612616991
VIPT30P	●	300 mm	12	5604612617035
VIPT20BE	●	200 mm	12	5604612616977
VIPT30BE	●	300 mm	12	5604612617011

Trilho

Guia

Rack

Crémaillère



Ref.		Dim.		Ean
VIT300B	○	300 mm	12	5604612616823
VIT500B	○	500 mm	12	5604612616861
VIT1000B	○	1000 mm	12	5604612616908
VIT2000B	○	2000 mm	12	5604612616946
VIT300AL	●	300 mm	12	5604612616809
VIT500AL	●	500 mm	12	5604612616847
VIT1000AL	●	1000 mm	12	5604612616885
VIT2000AL	●	2000 mm	12	5604612616922
VIT300P	●	300 mm	12	5604612616830
VIT500P	●	500 mm	12	5604612616878
VIT1000P	●	1000 mm	12	5604612616915
VIT2000P	●	2000 mm	12	5604612616953
VIT300BE	●	300 mm	12	5604612616816
VIT500BE	●	500 mm	12	5604612616854
VIT1000BE	●	1000 mm	12	5604612616892
VIT2000BE	●	2000 mm	12	5604612616939

Poleia para trilho duplo encaixe

Cartela doble encaje

Double bracket

Console pour crémaillère double



Ref.		Dim.		Ean
VIPTD17B	○	170 mm	12	5604612672508
VIPTD27B	○	270 mm	12	5604612672546
VIPTD17AL	●	170 mm	12	5604612672485
VIPTD27AL	●	270 mm	12	5604612672522
VIPTD17P	●	170 mm	12	5604612672515
VIPTD27P	●	270 mm	12	5604612672553
VIPTD17BE	●	170 mm	12	5604612672492
VIPTD27BE	●	270 mm	12	5604612672539

Trilho duplo encaixe

Guia doble encaje

Double rack

Crémaillère double

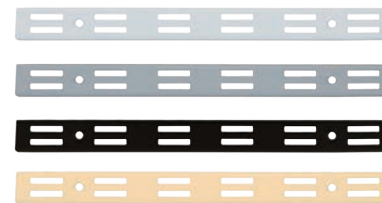

Ref.		Dim.		Ean
VITD300B	○	300 mm	12	5604612672348
VITD500B	○	500 mm	12	5604612672423
VITD1000B	○	1000 mm	12	5604612672430
VITD2000B	○	2000 mm	12	5604612672447
VITD300AL	●	300 mm	12	5604612672324
VITD500AL	●	500 mm	12	5604612672362
VITD1000AL	●	1000 mm	12	5604612672409
VITD2000AL	●	2000 mm	12	5604612672416
VITD300P	●	300 mm	12	5604612672355
VITD500P	●	500 mm	12	5604612672454
VITD1000P	●	1000 mm	12	5604612672461
VITD2000P	●	2000 mm	12	5604612672478
VITD300BE	●	300 mm	12	5604612672331
VITD500BE	●	500 mm	12	5604612672379
VITD1000BE	●	1000 mm	12	5604612672386
VITD2000BE	●	2000 mm	12	5604612672393



Fogão a gás portátil 1 bico
Cocina a gas portátil 1 quemador
Portable gas stove 1 burner
Rechaud à gaz portable 1 brûleur



Ref.		Ean
VIFGP1	6	5604612676315

Fogão de campismo
Fogón de camping
Camping stove
Réchaud de camping



Ref.		Ean
VIFC	12	5604612648909

Lanterna de campismo
Linterna de camping
Camping lantern
Lanterne de camping



Ref.		Ean
VILCA	12	5604612648916

Cartucho de gás

Cartucho de gas
Gas cartridge
Cartouche de gaz
- 227 g



Ref.		Ean
VICG227	28	5203917401723

Cartucho de gás com válvula

Cartucho de gas con válvula
Gas cartridge with valve
Cartouche de gaz a valve
- 190 g



Ref.		Ean
VICG190	36	5604612651657

Cj. de 2 camisas para lanterna a gás
Juego de 2 camisas para lanterna camping
Set of 2 gas mantles for camping lantern
Jeu 2 chemises pour lanterne de camping



Ref.		Ean
VICLG	200	5604612678951

Alicate multifunções com bolsa

Alicate multifuncion con bolso

Multipurpose plier with bag

Pince multifonctions avec étui

Aço inoxidável › Stainless steel
Acero inoxidable › Acier inoxidable

12 in 1



Ref.	Dim.		Ean
VIAMF	165 mm	6	5604612016180

Canivete multiusos › Multipurpose knife

Cuchillo multiusos › Couteau multifonctions

Aço inoxidável › Stainless steel
Acero inoxidable › Acier inoxidable

11 in 1



Ref.	Dim.		Ean
VICMU	85 mm	6	5604612659202

Afiador facas com ventosa

Afilador para cuchillos con ventosa

Knife sharpener with suction cup

Aiguiseur de couteaux avec ventouse



Ref.		Ean
VIAF	10	5604612113230

Alicate multifunções mini com bolsa

Alicate multifuncion mini con bolso

Mini multipurpose plier with bag

Pince multifonctions mini avec étui

Aço inoxidável › Stainless steel
Acero inoxidable › Acier inoxidable

9 in 1



Ref.	Dim.		Ean
VIAMFM	110 mm	6	5604612659196

Canivete multiusos › Multipurpose knife

Cuchillo multiusos › Couteau multifonctions

Aço carbono › Chorme steel
Acero cromado › Acier chromé



Ref.	Dim.		Ean
VICM180	180 mm	6	5604612629861

Canivete de electricista › Navaja de electricista

Navaja de electricista › Couteau d'electricien

Aço carbono cromado › Chorme steel
Acero cromado › Acier chromé



Ref.	Dim.		Ean
VICE	100 mm	6	5604612642334

Lanterna de bolso super Led

Linterna de bolsillo super Led

Super Led pocket flashlight

Lampe de poche super Led



Ref.	Dim.		Ean
VILBSL	75 mm	12	5604612666026

Tesoura inox profissional trinchar frango/leitão

Tijera profesional inox para trinchar pollo/lechón

Professional inox shears for cutting chicken/piglet

Ciseaux inox professionnels pour la coupe de poulet/porcelet

Aço inoxidável › Stainless steel
Acero inoxidable › Acier inoxydable

Ref.	Dim.		Ean
VITIPFL	260 mm	15	5604612672744

Tesoura para cortar frango

Tijera para cortar pollo

Poultry shears

Ciseaux à volaille

Aço inoxidável › Stainless steel
Acero inoxidable › Acier inoxydable

Ref.	Dim.		Ean
VITFG	260 mm	10	5604612642402

Tesoura para cortar peixe › Fish shears

Tijera para cortar pescado › Ciseaux à poisson

Aço inoxidável › Stainless steel
Acero inoxidable › Acier inoxydable

Ref.	Dim.		Ean
VITP21	190 mm	6	5604612642419

Tesoura de electricista › Electrician scissors

Tijera de electricista › Ciseaux électricien

Aço inoxidável › Stainless steel
Acero inoxidable › Acier inoxydable

Ref.	Dim.		Ean
VITE6	150 mm	6	5604612642396

Tesoura de alfaiate › Tailor scissors

Tijera de sastre › Ciseaux de tailleur

Aço carbono › Chorme steel
Acero cromado › Acier chromé

Ref.	Dim.		Ean
VITA10	250 mm	6	5604612642358

Tesoura de modista › Dressmaker scissors

Tijera de modista › Ciseaux de couture

Aço carbono cromado › Chorme steel
Acero cromado › Acier chromé

Ref.	Dim.		Ean
VITM6	150 mm	6	5604612642426
VITM7	175 mm	6	5604612642433
VITM8	200 mm	6	5604612642440

Tesoura de costura › Sewing scissors

Tijera de costura › Ciseaux lingère

Aço carbono cromado › Chorme steel
Acero cromado › Acier chromé

Ref.	Dim.		Ean
VITC5	125 mm	6	5604612642372
VITC6	150 mm	6	5604612642389

Tesoura de bordar › Embroider scissors

Tijera de bordar › Ciseaux à broder

Aço carbono cromado › Chorme steel
Acero cromado › Acier chromé

Ref.	Dim.		Ean
VITB4C	96 mm	12	5604612642365

**Consumíveis
e acessórios**

Consumibles
y accesorios

**Consumables
and accessories**

Consommables
et accessoires





Conjunto aplicador com 2 fitas embalar

Juego aplicador con 2 cintas de embalar

Tape dispenser with 2 packing tapes

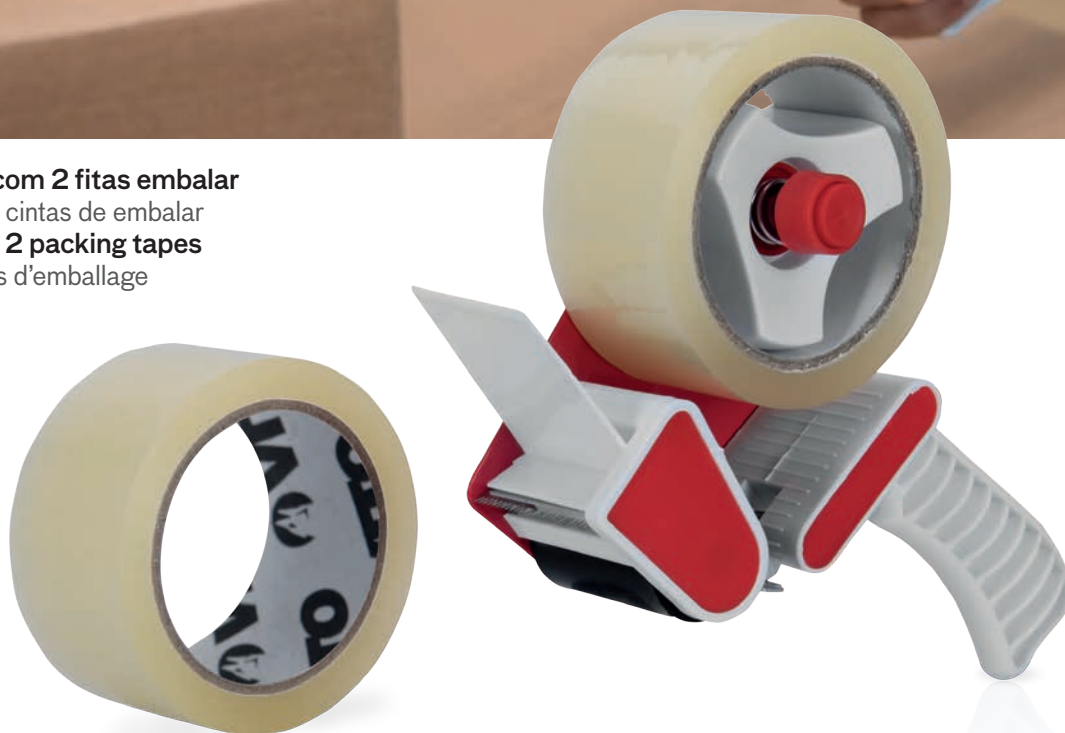
Dévidoir avec 2 rubans d'emballage



Ref.	Dim.		Ean
VICJAF	50 mm x 66 m	6	5604612662073

Fita de embalar transparente

Cinta de embalar transparente

Clear packing tape

Ruban adhésif emballage transparent



Ref.	Dim.		Ean
VIFE1966T	19 mm x 66 m	16	5604612128692

Fita de embalar transparente

Cinta de embalar transparente

Clear packing tape

Ruban adhésif emballage transparent



Ref.	Dim.		Ean
VIFE6650T	50 mm x 66 m	6	5604612128715

Fita de embalar castanha

Cinta de embalar marrón

Brown packing tape

Ruban adhésif emballage marron



Ref.	Dim.		Ean
VIFE6650C	50 mm x 66 m	6	5604612128708

Fita isoladora › Pvc insulation tape

Cinta aislante › Ruban adhésif isolant



Ref.	Dim.	COR		Ean
VIF1920A	19 mm x 20 m		120	5604612128784
VIF1920B	19 mm x 20 m		120	5604612128807
VIF1920P	19 mm x 20 m		120	5604612128814
VIF1920VA	19 mm x 20 m		120	5604612128821
VIF1920VM	19 mm x 20 m		120	5604612128838
VIF1920AZ	19 mm x 20 m		120	5604612128791
VIF1920CT	19 mm x 20 m		120	5604612615949

Fita de papel › Masking tape paper

Cinta de papel › Ruban de masquage en papier



Ref.	Dim.		Ean
VIFP1950	19 mm x 50 m	96	5604612128845
VIFP2550	25 mm x 50 m	72	5604612128852
VIFP3050	30 mm x 50 m	60	5604612128869
VIFP3850	38 mm x 50 m	48	5604612128876
VIFP5050	50 mm x 50 m	36	5604612128883

Fita de alumínio

Cinta de alumínio

Aluminium tape

Ruban adhésif aluminium



Ref.	Dim.		Ean
VIFA10	50 mm x 10 m	12	5604612622763

Fita universal extra forte

Cinta universal extra fuerte

Extra strong cloth tape

Ruban universelle extra fort



Ref.	Dim.		Ean
VIFEF25	50 mm x 25 m	12	5604612622756

Fita dupla face

Cinta doble cara

Double side tape

Ruban double face



Ref.	Dim.		Ean
VIFDF505	50 mm x 5 m	36	5604612128685

Fita antideslizante

Cinta antideslizante

Anti-slip tape

Bande antidérapant



Ref.	Dim.		Ean
VIFA2515	25 mm x 25 m	24	5604612684853

Fita antideslizante

Cinta antideslizante

Anti-slip tape

Bande antidérapant



Ref.	Dim.		Ean
VIFA5015	50 mm x 25 m	12	5604612684860

Fita bi-adesiva fina

Cinta adhesiva doble cara fina

Bi-adhesive tape

Ruban bi-adhésif



Ref.	Dim.		Ean
VIFBA5020	50 mm x 20 m	36	5604612662066



Tinta acrílica em spray
 Pintura acrílica en spray
Spray acrylic paint
 Peinture acrylique en spray

-  **VITSABR**
Branco brilhante › Brilliant white
Blanco brillante › Blanc brillant
-  **VITSABF**
Branco frigorífico › Fridge white
Blanco refrigerador › Blanc frigo
-  **VITSAZ**
Zinco › Zinc
Cinc › Zinc
-  **VITSAPR**
Preto fosco › Matte black
Negro mate › Noir mat
-  **VITSAPRB**
Preto brilhante › Brilliant black
Negro brilhante › Noir brillant
-  **VITSACA**
Castanho › Brown
Marrón › Marron
-  **VITSAVE**
Verde menta › Mint green
Verde menta › Vert menthe
-  **VITSAVP**
Verde primavera › Spring green
Verde › Vert printemps
-  **VITSAVMB**
Vermelho brilhante › Brilliant red
Rojo brillante › Rouge brillant

-  **VITSAAL**
Alumínio › Grey
Aluminio › Gris
-  **VITSACI**
Cinzento › Blue
Gris › Bleu
-  **VITSAAZ**
Azul › Blue
Azul › Bleu
-  **VITSACR**
Dourado › Golden
Dourado › Doré
-  **VITSAR**
Rosa › Rose
Rosa › Rose
-  **VITSAAM**
Amarelo › Yellow
Amarillo › Jaune
-  **VITSALA**
Laranja › Orange
Naranja › Orange
-  **VITSAVM**
Vermelho › Red
Rojo › Rouge



- › Uso geral: metal, madeira, plástico, vidro, etc
- › Uso general: metal, madera, plástico, vidrio, etc
- › General use: metal, wood, plastic, glass, etc
- › Usage général: métal, bois, plastique, verre, etc

Ref.	RAL	📦	Ean
VITSAPR	9005	6	5604612037345
VITSAPRB	9005	6	5604612037352
VITSABR	9010	6	5604612037291
VITSABF	9010	6	5604612037284
VITSAAM	1021	6	5604612037260
VITSAAZ	5017	6	5604612037277
VITSACA	8011	6	5604612037307
VITSACR	1014	6	5604612037321
VITSALA	2002	6	5604612037338
VITSAR	3015	6	5604612037369
VITSAVE	6029	6	5604612037376
VITSAVP	6002	6	5604612037390
VITSAVM	3000	6	5604612037383
VITSAVMB	3020	6	5604612660604
VITSAAL	9006	6	5604612119010
VITSACI	7001	6	5604612037314
VITSAZ	-	6	5604612013936

Tinta em spray acrílico cores metálicas

Pintura en spray acrílico colores metálicas

Acrylic spray paint metallic colours

Bombe peinture acrylique couleurs métalliques

- › Metal, madeira, plástico, vidro, etc.
- › Metal, madera, plástico, vidrio, etc
- › Metal, wood, plastic, glass, etc
- › Métal, bois, plastique, verre, etc



Ref.	Cor	Color	Color	Color	Coleur	Ean
VITSADO	Dourado	Dourado	Golden	Doré	6	5604612011932
VITSAPRA	Prateado	Plateado	Silver	Argenté	6	5604612037239
VITSACO	Cobre	Cobre	Cooper	Cuivre	6	5604612037222
VITSAC	Cromado	Cromado	Chrome	Chrome	6	5604612026264

Tinta em spray acrílico altas temperaturas

Pintura en spray acrílico en altas temperatura

High temperature acrylic spray paint

Bombe peinture acrylique hautes températures

- › Superfícies metálicas sujeitas a temperaturas altas
- › Superfícies metálicas sujetas a alta temperatura
- › Metallic surfaces subject to high temperatures
- › Surfaces métalliques soumises à des hautes températures



Ref.	Cor	Color	Color	Color	Coleur	Ean
VITSATPR	Preto	Negro	Black	Noir	6	5604612119188
VITSATAL	Alumínio	Aluminio	Grey	Gris	6	5604612037406

Tinta em spray acrílico verniz transparente

Pintura en spray acrílico barniz transparente

Transparent varnish acrylic spray paint

Bombe peinture acrylique vernis transparent

- › Metal, madeira, plástico, vidro, etc.
- › Metal, madera, plástico, vidrio, etc
- › Metal, wood, plastic, glass, etc
- › Métal, bois, plastique, verre, etc



Ref.	Ean
VITSAV	5604612026158

Tinta em spray acrílico fluorescente

Pintura en spray acrílico fluorescente

Acrylic fluorescent spray paint

Bombe peinture acrylique fluorescente

- › Elevada luminosidade reflectora
- › Elevada luminosidad reflectante
- › High reflective luminosity
- › Haute luminosité réfléchissante



Ref.	Cor	Color	Color	Color	Coleur	Ean
VITSAFVE	Verde	Verde	Green	Vert	6	5604612037253
VITSAFAM	Amarelo	Amarillo	Yellow	Jaune	6	5604612037246
VITSAFVM	Vermelho	Rojo	Red	Rouge	6	5604612011925

Tinta em spray acrílico primário

Pintura en spray acrílico primário

Primary acrylic spray paint

Bombe peinture acrylique primaire

- › Plástico e madeira
- › Plástico y madera
- › Plastic and wood
- › Plastique et bois



Ref.	Ean
VITSAP	5604612026141

Spray acrílico tratamento de superfície

Pintura en spray acrílica tratamiento superficie

Acrylic primary spray surface treatment

Bombe peinture acrylique traitement de surface

- › Elevada luminosidade reflectora
- › Elevada luminosidad reflectante
- › High reflective luminosity
- › Haute luminosité réfléchissante



Ref.	Ean
VITSATS	5604612657901



Conjunto de 3 lixas de ferro

Juego de 3 lijas de hierro
Set of 3 metal sandpaper
 Jeu de 3 feuilles abrasives pour fer

› 280 x 230 mm

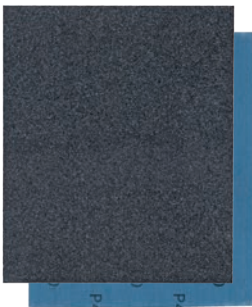

Ref.	Grid	Box	Ean
VILF40BL	G 40	12	5604612093501
VILF50BL	G 50	12	5604612108465
VILF60BL	G 60	12	5604612108472
VILF80BL	G 80	12	5604612108397
VILF100BL	G 100	12	5604612108618
VILF120BL	G 120	12	5604612108403
VILF150BL	G 150	12	5604612108427
VILF180BL	G 180	12	5604612089924
VILF220BL	G 220	12	5604612093495
VILF240BL	G 240	12	5604612093686

Conjunto de 3 lixas de água

Juego de 3 lijas de agua
Set of 3 water sandpaper
 Jeu de 3 feuilles abrasives à l'eau

› 280 x 230 mm



Ref.	Grid	Box	Ean
VILA60BL	G 60	12	5604612683467
VILA80BL	G 80	12	5604612683474
VILA100BL	G 100	12	5604612683481
VILA120BL	G 120	12	5604612093648
VILA150BL	G 150	12	5604612683498
VILA180BL	G 180	12	5604612093990
VILA220BL	G 220	12	5604612093419
VILA240BL	G 240	12	5604612093594
VILA280BL	G 280	12	5604612683504
VILA320BL	G 320	12	5604612093631
VILA360BL	G 360	12	5604612093402
VILA400BL	G 400	12	5604612683511
VILA500BL	G 500	12	5604612093396
VILA600BL	G 600	12	5604612093556
VILA800BL	G 800	12	5604612683528
VILA1000BL	G 1000	12	5604612683535

Conjunto de 3 lixas de madeira

Juego de 3 lijas de madera
Set of 3 wood sandpaper
 Jeu de 3 feuilles abrasives pour bois

› 280 x 230 mm

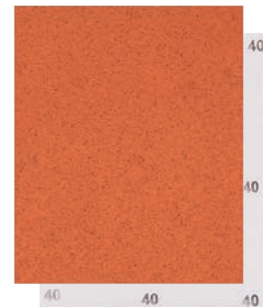

Ref.	Grid	Box	Ean
VILM40BL	G 40	12	5604612093464
VILM50BL	G 50	12	5604612093471
VILM60BL	G 60	12	5604612093488
VILM80BL	G 80	12	5604612093457
VILM100BL	G 100	12	5604612089931
VILM120BL	G 120	12	5604612093440
VILM150BL	G 150	12	5604612093716
VILM180BL	G 180	12	5604612093679
VILM220BL	G 220	12	5604612093426
VILM240BL	G 240	12	5604612093433
VILM280BL	G 280	12	5604612093655
VILM320BL	G 320	12	5604612093662

Conjunto de 50 lixas de ferro

Juego de 50 lijas de hierro
Set of 50 metal sandpaper
 Jeu de 50 feuilles abrasives pour fer



› 280 x 230 mm



Ref.	Grid	Quantity	Ean
VILF40	G 40	50	5604612030162
VILF50	G 50	50	5604612030179
VILF60	G 60	50	5604612030186
VILF80	G 80	50	5604612030193
VILF100	G 100	50	5604612030209
VILF120	G 120	50	5604612030216
VILF150	G 150	50	5604612030223
VILF180	G 180	50	5604612030230
VILF220	G 220	50	5604612030247
VILF240	G 240	50	5604612030254

Conjunto de 50 lixas de água

Juego de 50 lijas de agua
Set of 50 water sandpaper
 Jeu de 50 feuilles abrasives à l'eau



› 280 x 230 mm

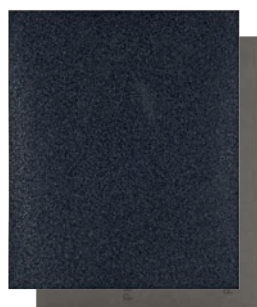

Ref.	Grid	Quantity	Ean
VILA60	G 60	20	5604612029982
VILA80	G 80	20	5604612029999
VILA100	G 100	20	5604612030001
VILA120	G 120	20	5604612030018
VILA150	G 150	20	5604612030025
VILA180	G 180	20	5604612030032
VILA220	G 220	20	5604612030063
VILA240	G 240	20	5604612030070
VILA280	G 280	20	5604612030087
VILA320	G 320	20	5604612030094
VILA360	G 360	20	5604612030100
VILA400	G 400	20	5604612030117
VILA500	G 500	20	5604612030124
VILA600	G 600	20	5604612030131
VILA800	G 800	20	5604612030148
VILA1000	G 1000	20	5604612030155

Conjunto de 50 lixas de madeira

Juego de 50 lijas de madera
Set of 50 wood sandpaper
 Jeu de 50 feuilles abrasives pour bois



› 280 x 230 mm

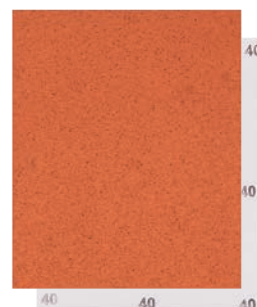

Ref.	Grid	Quantity	Ean
VILM40	G 40	20	5604612030261
VILM50	G 50	20	5604612030278
VILM60	G 60	20	5604612030285
VILM80	G 80	20	5604612030292
VILM100	G 100	20	5604612030308
VILM120	G 120	20	5604612030315
VILM150	G 150	20	5604612030322
VILM180	G 180	20	5604612030339
VILM220	G 220	20	5604612030346
VILM240	G 240	20	5604612030353
VILM280	G 280	20	5604612030360
VILM320	G 320	20	5604612030377

Taco de lixa › Sandpaper sponge

Taco de lija › Tampon abrasif

› 70 x 10 x 100 mm



Ref.	Grid	Quantity	Ean
VITLF80	G 80	500	5604612628444
VITLF100	G 100	500	5604612139391
VITLF120	G 120	500	5604612139407

Taco de lixa fino › Fine sanding sponge

Taco de lija fino › Tampon abrasif fin

› 70 x 23 x 100 mm



Ref.	Grid	Quantity	Ean
VITL80	G 80	500	5604612029531
VITL100	G 100	500	5604612029517
VITL120	G 120	500	5604612029524

Taco em borracha para lixa › Rubber sanding block

Taco en goma para lija › Cale de ponçage en caoutchouc

› 70 x 130 mm



Ref.	Quantity	Ean
VITBL	6	5604612035891

Conjunto de 5 lixas › Set of 5 sandpapers

Juego de 5 lijas › Jeu de 5 feuilles abrasives

› 280 x 115 mm



Ref.	Grid	Quantity	Ean
VICL80	G 80	20	5604612643096
VICL100	G 100	20	5604612643164
VICL120	G 120	20	5604612643102



Pistola de colar profesional

Pistola de encolar profesional

Professional glue gun

Pistolet à colle chaude
professionnel

180 W

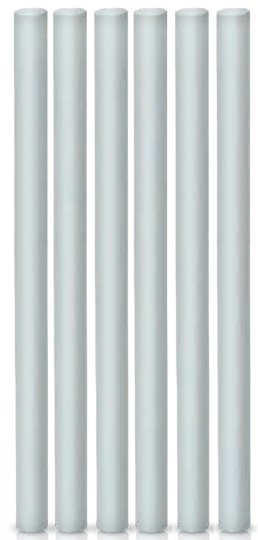

Ref.	Ø		Ean
VIPC300	10 mm	1	5604612651190

Pistola de colar
 Pistola de encolar
Glue gun
 Pistolet à colle chaude



Ref.	Ø		Ean
VIPCB60	10 mm	12	5604612644635

Pistola de colar
 Pistola de encolar
Glue gun
 Pistolet à colle chaude



Ref.	Ø		Ean
VIPCB40	10 mm	12	5604612644628

Conjunto de 10 sticks de cola › Set of 10 glue sticks
 Juego de 10 barras de pegamento › Jeu de 10 bâtonnets de colle



Ref.	W	Pack	Ø		Ean
VICL2B	10 W	10	7 mm	12	5604612644666
VICL1B	40/60 W	10	10 mm	6	5604612644659

Cola em barra › Glue stick
 Cola en barra › Colle pour pistolet



Ref.	W	Pack	Ø		Ean
VICL1	40/60 W	1 kg	10 mm	20	5604612644642

Conjunto de 2 tubos de super cola
 Conjunto de 2 tubos de super pegamento
Set of 2 tubes of super glue
 Jeu de 2 tubes de super colle



Ref.	(kg)		Ean
VISSC2	2 x 3 g	12	5604612104337

Cola para madeira
 Pegamento para madeira
Wood glue
 Colle à bois



Ref.	(kg)		Ean
VICM	70 g	12	5604612104320

Cola de contacto líquida
 Pegamento de contacto líquido
Liquid contact glue
 Colle de contact liquide



Ref.	(kg)		Ean
VICC	50 gr	24	5604612104306



Pistola de mastique profissional

Pistola de silicona professional

Professional caulking gun

Pistolet d'étanchéité à cartouche professionnel



Ref.	Ean
VIPM3	5604612004958

Pistola de mastique tubo alumínio

Pistola de silicona tubo aluminio

Caulking gun aluminium tube

Pistolet d'étanchéité à cartouche aluminium



Ref.	Ean
VIPM2	5604612004965

Pistola de mastique

Pistola de silicona

Caulking gun

Pistolet d'étanchéité à cartouche



Ref.	Ean
VIPM1	5604612625771

Pistola para espuma de poliuretano

Pistola para espuma de poliuretano

Polyurethane foam gun

Pistolet mousse polyurethane

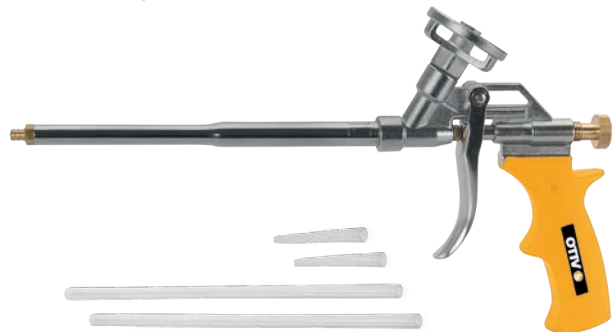

Ref.	Ean
VIPEU	5604612665081

Auto



Carregador de bateria inteligente
 Cargador de baterías inteligente
Smart battery charger
 Chargeur de batterie intelligent



12 V



Tensão de carga › Charging voltage	12 V
Capacidade de carregamento › Charging capacity	1,4 - 80 Ah
Corrente de carga máx. › Charging current	3,5 A
Tensão de alimentação › Power voltage	220 V - 50 Hz
Temp. de trabalho › Working temp.	20 - 50° C
Índice de proteção › Insulation class	IP20

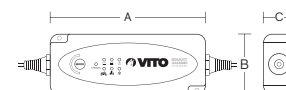

Ref.	A x B x C	Ean
VICBI12	160 x 60 x 30 mm	5604612668877



VITO AUTO



FUSE



20A

12V



24V

FUSE

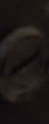

15A

ON



OFF

SAIDA OUTPUT
SALIDA SORTIE

POWER 12V/24V
MIX. 180W/100W/20A
12V/24V 20A

12V/24V

Carregador de bateria › Battery charger

Cargador de batería › Chargeur de batterie



12/24 V

- › Equipado com protecção contra inversão de polaridade e sobrecargas.
- › Proveído de protección contra cambios de polaridad y sobrecargas.
- › Provided with protection against reverse polarity and overload.
- › Equipé avec protection contre les changements de polarité et des surcharges.



Tensão de carga › Charging voltage	12 - 24 V
Capacidade de carregamento › Charging capacity	28 - 180 Ah
Corrente de carga máx. › Charging current	20 A
Potência máxima › Max. power	160 W
Tensão de alimentação › Power voltage	220 V - 50 Hz
Índice de proteção › Insulation class	IP20

Ref.	A x B x C	Ean
VICB16S	240 x 160 x 190 mm	5604612644734

Carregador de bateria › Battery charger

Cargador de batería › Chargeur de batterie



6/12 V

- › Equipado com protecção contra inversão de polaridade e sobrecargas.
- › Proveído de protección contra cambios de polaridad y sobrecargas.
- › Provided with protection against reverse polarity and overload.
- › Equipé avec protection contre les changements de polarité et des surcharges.



Tensão de carga › Charging voltage	6 - 12 V
Capacidade de carregamento › Charging capacity	20 - 75 Ah
Corrente de carga máx. › Charging current	10 A
Potência máxima › Max. power	140 W
Tensão de alimentação › Power voltage	220 V - 50 Hz
Índice de proteção › Insulation class	IP20

Ref.	A x B x C	Ean
VICB10E	203 x 113 x 155 mm	5604612642167

Arrancador de baterias portátil › Multipurpose Jump starter

Jump starter multifunciones › Booster de démarrage

14000 mAh

Capacidade da bateria › Battery capacity	14000 mAh
Arrancador de bateria › Jump starter	12 V
Capacidade de arranque › Starter capacity	≤ 100 A
Corrente máxima › Maximum current	400 A
Corrente pico › Inrush current	600 A
	12 V - 2 A
Saídas › Outputs	16 V - 3,5 A
	19 V - 3,5 A
Saída USB › USB outlet	5 V - 2,1 A
Entrada › Input	15 V - 1 A
Tempo de carregamento › Charging time	3 h
Temperatura de trabalho › Working temperature	0 - 80° C



Accessórios incluídos › Accesorios incluidos › Accessories included › Accessoires inclus

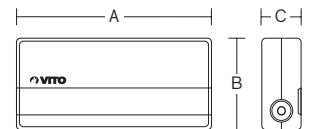

Ref.	A x B x C	Ean
VJJS14000	145 x 68 x 30 mm	5604612668860

Arrancador de baterias portátil › Multipurpose Jump starter

Jump starter multifunciones › Booster de démarrage

8000 mAh

Capacidade da bateria › Battery capacity	8000 mAh
Arrancador de bateria › Jump starter	12 V
Capacidade de arranque › Starter capacity	≤ 60 A
Corrente inicial › Initial current	200 A
Corrente máxima › Maximum current	400 A
Saídas › Output	5 V - 2 A
	15 V - 1 A
Entrada › Input	15 V - 1 A
Tempo de carregamento › Charging time	3 h
Temperatura de trabalho › Working temperature	0 - 60° C



Accessórios incluídos › Accesorios incluidos › Accessories included › Accessoires inclus

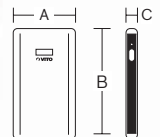

Ref.	A x B x C	Ean
VJJS8000	75 x 131 x 25 mm	5604612668853



Macaco rolante › Floor jack
Gato hidráulico › Cric rouleur



Ref.	Cap.	↑	☐	Ean
VIMR2	2 ton.	135-335 mm	1	5604612021078

Macaco hidráulico
Gato hidráulico
Bottle jack
Cric-bouteille
hydraulique



Ref.	Cap.	↑	☐	Ean
VIMH2	2 t	148-278 mm	10	5604612014827
VIMH4	4 t	180-340 mm	8	5604612014834
VIMH8	8 t	200-385 mm	4	5604612014841
VIMH10	10 t	200-385 mm	4	5604612020927
VIMH12	12 t	210-395 mm	4	5604612014858
VIMH16	16 t	225-425 mm	2	5604612014865
VIMH20	20 t	235-440 mm	2	5604612020934
VIMH32	32 t	255-405 mm	2	5604612020941

Chave de filtro de óleo
Llave de filtro de aceite
Oil filter wrench
Clé filtre à huile



Ref.	☐	Ean
VICHFO	6	5604612613259

Chave de velas
Llave de bujías
T type socket wrench
Clé à bougie articulée



Ref.	Dim.	☐	Ean
VICHV16	16 mm	12	5604612613273
VICHV21	21 mm	12	5604612613266

Conjunto de 2 cavaletes auto
Conjunto de 2 soportes tipo tripode
Set of 2 jack stands
Jeu de 2 chandelles pliantes



Ref.	Cap.	↑	☐	Ean
VICV2	2 ton.	265 - 425 mm	1	5604612027100

Inverter auto › Inverter auto
 Inverter auto › Convertisseur auto

120 w



Potência contínua › Continuous power	120 W
Potência de pico › Inrush power	250 W
Tensão de alimentação › Power voltage	11 - 14 V
Saídas USB › Output USB	3 x 2,1 A
Tomada AC › AC Outlet	230 V - 50 Hz
Corrente de proteção (Fusível) › Protection current (fuse)	15 A
Temp. de trabalho › Working temp.	0 - 60° C



Ref.	A x B x C	Ean
VIIA120	90 x 104 x 62 mm	5604612668846

Bomba de pé
 Bombin de pie
 Foot pump
 Pompe à pied

› 200 cm³
 › 5 bar



Ref.	Ean
VIBP	5604612112028

Chave de rodas cromada
 Llave de ruedas cromada
 Cross wheel spanner
 Clé en croix chromée

› 17 · 19 · 21 · 23 mm



Ref.	Ean
VICRO	5604612613242

Mini compressor portátil
 Mini compresor portatil
 Mini portable compressor
 Mini compresseur portatif



Pressão máxima › Maximum pressure	250 psi - 17 bar
Tensão de alimentação › Power voltage	DC 12 V
Capacidade › Capacity	15 L/ min
Cabo de alimentação › Power cable	2,8 m

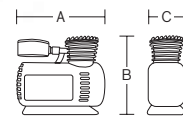

Ref.	A x B x C	Ean
VICO12VA	130 x 120 x 70 mm	5604612672737

Bomba de pé dupla
 Bombin de pie doble
 Double barrel foot pump
 Pompe à pied double corps

› 2 x 166 cm³
 › 5 bar



Ref.	Ean
VIBPD	5604612112035

Cabos de bateria
 Cables de batería
 Booster cable kit
 Câbles de démarrage

› 3 m



Ref.	Ean
VICB500	5604612038038



Champô auto
 Champú auto
Car shampoo
 Shampooing auto



Ref.	Cap.		Ean
VISH1	1 L	6	5604612626600

Ref.	Cap.		Ean
VISH5	5 L	4	5604612626617

Limpa tablier
 Limpia salpicadero
Dashboard cleaner
 Nettoyant tableau de bord



Ref.	Cap.		Ean
VICSP1	1 L	6	5604612626716

Brilho pneus
 Abrillantador de neumáticos
Tire brightener
 Nettoyant pneus



Ref.	Cap.		Ean
VIBPP1	1 L	6	5604612626686

Limpa jantes
 Limpia llantas
Rims cleaner
 Nettoyant pour jantes



Ref.	Cap.		Ean
VILJP1	1 L	6	5604612626693

Limpa estofos
 Limpia tapicerías
Upholstery cleaner
 Nettoyant tissus



Ref.	Cap.		Ean
VILEP1	1 L	6	5604612626709

Líquido radiador › Radiator liquide

Líquido radiador › Liquide radiateur

› - 5° C
› 10 %

Ref.	Cap.	📦	Ean
VICF101	1 L	6	5604612626662
VICF105	5 L	4	5604612626679

Limpa vidros com pistola

Limpa cristales con pistola

Spray glass cleaner

Nettoyant vitres à pistolet



Ref.	Cap.	📦	Ean
VILVP1	1 L	6	5604612626723

Lubrificante multiusos

Lubricante multiusos

Multipurpose lubricant

Lubrifiant multi-usages



Ref.	Cap.	📦	Ean
VILM400	400 ml	12	5604612626747

Anticongelante › Antifreeze

Anticongelante › Antigél

› - 11° C
› 20 %

Ref.	Cap.	📦	Ean
VIAC201	1 L	6	5604612626648
VIAC205	5 L	4	5604612626655

Spray limpa tablier

Spray limpa salpicadero

Dashboard cleaner

Nettoyant tableau de bord



Ref.	Cap.	📦	Ean
VICS600	600 ml	12	5604612626730

Massa consistente

Grasa para engrase

Grease

Graisse lubrifiante



Ref.	Cap.	📦	Ean
VIMC400	400 gr	24	5604612626877
VIMC1	1 Kg	12	5604612644918
VIMC5	5 Kg	4	5604612626884

Limpa vidros

Limpa cristales

Glass cleaner

Nettoyant vitres



Ref.	Cap.	📦	Ean
VILV1	1 L	6	5604612626624
VILV5	5 L	4	5604612626631

Água destilada

Água destilada

Distilled water

Eau distillée



Ref.	Cap.	📦	Ean
VIAD1	1 L	6	5604612626754
VIAD5	5 L	3	5604612626761

Desperdício de algodão

Chatarra de algodão

Scrap cotton

Mèche de coton



Ref.	Cap.	📦	Ean
VID1	+/- 1 Kg	1	5604612632687
VID5	+/- 5 Kg	1	5604612632694



Jerry can para gasolina
 Bidón para gasolina
 Gasoline jerry can
 Jerrican pour essence

› HDPE
 › SI 1982/630



Ref.	Cap.	📦	Ean
VIJCG3	3 L	12	5604612670726
VIJCG5	5 L	10	5604612135782

Ref.	Cap.	📦	Ean
VIJCG10	10 L	6	5604612135799
VIJCG20	20 L	6	5604612135805

Jerry can combinado para gasolina + óleo
 Bidón combinado para gasolina + aceite
Combi jerry can gasoline + oil
 Jerrican combiné essence + huile

› HDPE
 › SI 1982/630



Ref.	Cap.	📦	Ean
VIJCC53	5 L + 3 L	4	5604612670733

Óleo para motor de 4 tempos
 Aceite para motor de 4 tiempos
Engine lubricant for 4 stroke engines
 Lubrifiant pour moteur 4 temps

› 15W40



Ref.	Cap.	📦	Ean
VIOM4T	1 L	6	5604612177263

Óleo sintético para motor de 2 tempos
 Aceite sintético para motor de 2 tiempos
Engine lubricant for 2 stroke engines
 Huile de synthèse pour moteur 2 temps



Ref.	Cap.	📦	Ean
VIOM2T100	100 ml	12	5604612639723
VIOM2T	1 L	6	5604612177256
VIOM2T5	5 L	4	5604612644932

Óleo para corrente de motosserra
 Aceite para cadena de motosierra
Lubricant saw's chain
 Lubrifiant pour chaîne de tronçonneuse



Ref.	Cap.	📦	Ean
VIOCM1	1 L	6	5604612626860
VIOCM5	5 L	4	5604612639259



Cinta de fixação › Lashing strap
Cinta de amarre › Sangle de fixation

Máx 4500 KG



Ref.	Dim.		Ean
VICF50825G	5 cm x 8,25 m	5	5604612640354

Cinta de fixação › Lashing strap
Cinta de amarre › Sangle de fixation

Máx 550 KG



Ref.	Dim.		Ean
VICF2550	2,5 cm X 5 m	12	5604612640323

Cinta de fixação › Lashing strap
Cinta de amarre › Sangle de fixation

Máx 2500 KG



Ref.	Dim.		Ean
VICF3345G	3,3 cm x 4,5 m	5	5604612640347

Cinta de fixação › Lashing strap
Cinta de amarre › Sangle de fixation

Máx 250 KG



Ref.	Dim.		Ean
VICF2525	2,5 cm x 2,6 m	12	5604612640316

Cinta de fixação › Lashing strap
Cinta de amarre › Sangle de fixation

Máx 550 KG



Ref.	Dim.		Ean
VICF2550G	2,5 cm x 5 m	10	5604612640330

Cinta de reboque

Cinta de remorque
Tow strap
Sangle pour remorque



Ref.	Dim.		Ean
VICR5045	5 cm x 4,5 m	5	5604612640378

Conjunto de 2 esticadores de bagagem gancho duplo

Conjunto de 2 tensores de equipaje gancho doble

Set of 2 elastic cord double hook

Jeu de 2 tendeurs de bagage crochet double

4x 



Ref.	Dim.		Ean
VIEB60	8 mm x 60 cm	24	5604612640262
VIEB80	8 mm x 80 cm	24	5604612640279
VIEB100	8 mm x 100 cm	24	5604612640286

Esticador de bagagem aranha

Tensores de equipaje araña

Elastic cords hooks

Tendeurs type araignée

8x 



Ref.	Dim.		Ean
VIEARA	8 mm x 80 cm	24	5604612640293

Cj. de 4 esticadores de bagagem

Conjunto de 4 tensores de equipaje

Set of 4 elastic cords

Jeu de 4 tendeurs de bagage

8x 



Ref.	Dim.		Ean
VIEB25	4 mm x 25 cm	20	5604612640255

Conjunto de 6 ganchos duplos

Conjunto de 6 ganchos dobles

Set of 6 double strength hook

Jeu de 6 crochets doubles



Ref.	Dim.		Ean
VIGD6		40	5604612640408

Esticador de bagagem - rolo

Tensores de equipaje - rolo

Elastic cord - reel

Tendeurs de bagage roule au



Ref.	Dim.		Ean
VIEBI100	8 mm x 100 m	1	5604612640309

Rede de carga › Cargo net

Red de carga › Filet de charge

6x 



Ref.	Dim.		Ean
VIRC30	30 x 30 cm	24	5604612640385

Rede de carga › Cargo net

Red de carga › Filet de charge

12x 

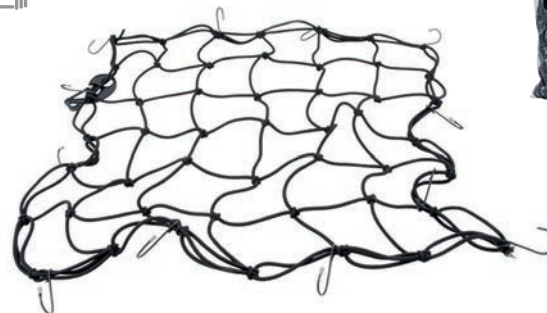

Ref.	Dim.		Ean
VIRC75	75 x 75 cm	24	5604612640392

Cadeado para bicicleta/moto

Candado para bicicleta/moto

Bicycle/motorcycle lock

Cadenas pour vélo/moto



Ref.		Dim.		Ean
VICBV		100 cm	15	5604612667269
VICBA		100 cm	15	5604612667283
VICBVM		100 cm	15	5604612667276

Cadeado para bicicleta/moto com combinação

Candado para bicicleta/moto con combinación

Combination bicycle/motorcycle lock

Cadenas pour vélo/moto à combinaison



Ref.	Dim.		Ean
VICBC	100 cm	15	5604612667290

Planogramas

Planogramas

Planogram

Planogramme

Ferramentas mecânicas e corte

Herramientas mecánicas y corte

Mechanical and cutting tools

Outils mécaniques et de coupe

**Construção, medição e nivelção, aplicação de cerâmica**

Construcción, útiles de medida y precisión, aplicación de cerámica

Construction, measurement and leveling, ceramic application

Construction, mesure et nivellement, application de céramique



Pintura, canalização e acessórios de ar comprimido

Pintura, fontanería y útiles de aire comprimido

Painting, piping and compressed air accessories

Peinture, tuyauterie et accessoires d'air comprimé



Brocas, discos e lixas

Brocas, discos y lijas

Drills, discs and sandpapers

Forets, disques et papiers de verre



Bricolage

Bricolage

Bricolage

Bricolage



Alicates

Alicates

Pliers

Pinces



Arrumação

Cajas herramientas

Tool storage

Rangement d'outils



Linear Auto

Lineal Auto

Auto linear

Linéaire Auto



Expositor modular simples

Expositor modular simple

Simple modular display

Présentoir modulaire simple

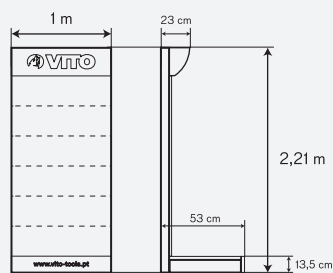
**Ganchos cromados simples com porta preços**

Ganchos cromados simples con portaprecios

Simple chrome hooks with price tag holder

Crochets chromés simples avec porte-prix

**Aplicação de marca acrílico + sticker - 4 opções**

Aplicación de marca acrílico+ sticker - 4 opciones

Acrylic panel application + sticker - 4 options

Application du panneau en acrylique + autocollant - 4 options

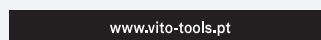
VITO**VITO-AUTO****Inclui personalização de 50 ganchos**

Incluye personalización y 50 ganchos

Includes customization and 50 hooks

Comprend personnalisation et 50 crochets

Ref.	Composição › Composición › Composition › Composition	Dim.	
VIEXB	Base › Base Base › Base	9,7 x 44,7 x 3,0 cm	1
VIEXPFB	Painel frontal base › Base frontal panel Painel frontal base › Panneau frontal de la base	97 x 10 cm	1
VIEXSB	Suporte da base › Base support Soporte de la base › Soutien de la base	9,5 x 51,7 x 6,5 cm	2
VIEXP1,5	Perfil › Profile Perfil › Profil	1,5 m (1,65 m)	2
VIEX0,3	Perfil › Profile Perfil › Profil	0,3 m (1,65 m)	2
VIEXT	Topo › Top Topo › Entête	96,5 x 25 cm	1
VIEXPPP	Painel perfurado preto › Perforated black panel Panel perfurado negro › Panneau perforé noir	96 x 30 cm	6
VIEXGC	Gancho cromado › Chrome hook Gancho cromado › Crochet chromé	5 mm x 25 cm	10
VIEXGCPP	Gancho cromado com porta-preços › Chrome hook with price tag holder Gancho cromado con portaprecios › Crochet chromé avec porte-prix	5 mm x 25 cm	40
VIEXPP1,5	Pé para perfil › Profile adjustable foot Pie para perfil › Pied régulateur pour profil		4
VIEXV	Acrílico + sticker VITO › Acrylic + VITO sticker Acrílico + sticker VITO › Acrylique + autocollant VITO	96 x 27 cm - 96 x 16 cm	2

Expositor modular duplo

Expositor modular duplo

Double modular display

Présentoir modulaire double

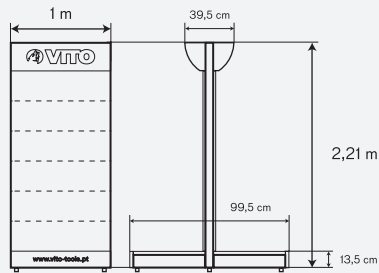
**Ganchos cromados simples com porta preços**

Ganchos cromados simples con portaprecios

Simple chrome hooks with price tag holder

Crochets chromés simples avec porte-prix

**Aplicação de marca acrílico + sticker - 4 opções**

Aplicación de marca acrílico+ sticker - 4 opciones

Acrylic panel application + sticker – 4 options

Application du panneau en acrylique + autocollant – 4 options

VITO

www.vito-tools.pt

VITO-AUTO

www.vito-tools.pt

Inclui personalização de 50 ganchos

Incluye personalización y 50 ganchos

Includes customization and 50 hooks

Comprend personnalisation et 50 crochets

Ref.	Composição › Composición › Composition › Composition	Dim.	
VIEXB	Base › Base Base › Base	9,7 x 44,7 x 3,0 cm	2
VIEXFBB	Painel frontal base › Base frontal panel Painel frontal base › Panneau frontal de la base	97 x 10 cm	2
VIEXSBD	Suporte da base › Base support Soporte de la base › Soutien de la base	9,5 x 51,7 x 6,5 cm	2
VIEXP1,5	Perfil › Profile Perfil › Profil	1,5 m (1,65 m)	2
VIEX0,3	Perfil › Profile Perfil › Profil	0,3 m (1,65 m)	2
VIEXT	Topo › Top Topo › Entête	96,5 x 25 cm	2
VIEXPPP	Painel perfurado preto › Perforated black panel Panel perfurado negro › Panneau perforé noir	96 x 30 cm	12
VIEXGC	Gancho cromado › Chrome hook Gancho cromado › Crochet chromé	5 mm x 25 cm	20
VIEXGCPP	Gancho cromado com porta-preços › Chrome hook with price tag holder Gancho cromado con portaprecios › Crochet chromé avec porte-prix	5 mm x 25 cm	80
VIEXPP1,5	Pé para perfil › Profile adjustable foot Pie para perfil › Pied régulateur pour profil		6
VIEXV	Acrílico + sticker VITO › Acrylic + VITO sticker Acrílico + sticker VITO › Acrylique + autocollant VITO	96 x 27 cm - 96 x 16 cm	4

Expositor modular simples

Expositor modular simple

Simple modular display

Présentoir modulaire simple



Ref.	Dim.	
VIEXGC	5 mm x 25 cm	1

Gancho cromado com porta-preços

Gancho cromado con portaprecios

Chrome hooks with price tag holder

Crochets chromés simples avec porte-prix



Ref.	Dim.	
VIEXGCPP	5 mm x 25 cm	1

Suporte para martelo 1

Suporte para martillo 1

Hammer support 1

Soutien pour marteau 1



Ref.	Dim.	
VIEXSM1	23 x 19 x 7,5 cm	1

Suporte para martelo 2

Suporte para martillo 2

Hammer support 2

Soutien pour marteau 2



Ref.	Dim.	
VIEXSM2	23 x 19 x 7,5 cm	1

Prateleira › Shelf

Estante › Étagère



Ref.	Dim.	
VIEXPRA	96,5 x 40 x 3,0 cm	1

Expositor misto - 144 chaves Pro › Mixed display – 144 screwdrivers Pro

Expositor mixto - 144 destornilladores Pro › Présentoir mixte – 144 clés Pro



Ref.	Composição Composition	Dim.	Qtd.
VICFPB375	Chave fenda › Screwdriver › Destornillador › Tournevis: pro	3,0 x 75 mm	12
VICFPB5100	Chave fenda › Screwdriver › Destornillador › Tournevis: pro	5,0 x 100 mm	12
VICFPB65125	Chave fenda › Screwdriver › Destornillador › Tournevis: pro	6,5 x 125 mm	12
VICFPB65150	Chave fenda › Screwdriver › Destornillador › Tournevis: pro	6,5 x 150 mm	12
VICPHPB1	Chave › Screwdriver › Destornillador › Tournevis: phillips pro	PH1 x 75 mm	12
VICPHPB2	Chave › Screwdriver › Destornillador › Tournevis: phillips pro	PH2 x 100 mm	12
VICPHPB3	Chave › Screwdriver › Destornillador › Tournevis: phillips pro	PH3 x 150 mm	12
VICPZPB0	Chave › Screwdriver › Destornillador › Tournevis: pozidrive pro	PZ0 x 60 mm	12
VICPZPB1	Chave › Screwdriver › Destornillador › Tournevis: pozidrive pro	PZ 1 x 80 mm	12
VICPZPB2	Chave › Screwdriver › Destornillador › Tournevis: pozidrive pro	PZ 2x 100 mm	12
VICTPB10	Chave › Screwdriver › Destornillador › Tournevis: torx pro	TO x 80 mm	12
VICTPB20	Chave › Screwdriver › Destornillador › Tournevis: torx pro	TO x 125 mm	12
Total			145

**Expositor balcão para colas › Glue counter display**

Expositor balcón para pegamento › Présentoir de comptoir pour des colles



Ref.	Composição › Composition Composición › Composition	Qtd.
VISCC2	Super cola 2 un. › Super glue 2 uds. Super pegamento 2 un. › Super colle 2 un.	48
VICM	Cola para madeira › Wood glue Pegamento para madeira › Colle à bois	24
VICC	Cola de contacto líquida › Liquid contact glue Pegamento de contacto líquida › Colle liquide de contact	36
Total		108

**Expositor de lixas › Sandpaper exhibitor**

Expositor lijas › Présentoir de papiers de verre



Ref.	Composição › Composición › Composition › Composition	Gr.	Qtd.
VILM60	Lixa de madeira › Wood sandpaper › Lija de madera › Papier de verre pour bois	60	50
VILM100	Lixa de madeira › Wood sandpaper › Lija de madera › Papier de verre pour bois	100	100
VILM150	Lixa de madeira › Wood sandpaper › Lija de madera › Papier de verre pour bois	150	100
VILM220	Lixa de madeira › Wood sandpaper › Lija de madera › Papier de verre pour bois	220	100
VILA150	Lixa de água › Water sandpaper › Lija de agua › Papier de verre à l'eau	150	50
VILA240	Lixa de água › Water sandpaper › Lija de agua › Papier de verre à l'eau	240	100
VILA360	Lixa de água › Water sandpaper › Lija de agua › Papier de verre à l'eau	360	100
VILA600	Lixa de água › Water sandpaper › Lija de agua › Papier de verre à l'eau	600	50
VILF60	Lixa de ferro › Metal sandpaper › Lija de hierro › Papier de verre pour fer	60	50
VILF100	Lixa de ferro › Metal sandpaper › Lija de hierro › Papier de verre pour fer	100	100
VILF150	Lixa de ferro › Metal sandpaper › Lija de hierro › Papier de verre pour fer	150	100
VILF220	Lixa de ferro › Metal sandpaper › Lija de hierro › Papier de verre pour fer	220	100
Total			1000





Expositor de tintas

Expositor de tintas

Painting display

Présentoir de peintures



Ref.	Composição › Composition Composición › Composition	Qtd.
VITSAPR	Spray acrílico preto fosco › Acrylic spray matt black Spray acrílico negro mate › Spray acrylique Noir mate	6
VITSAAL	Spray acrílico alumínio › Acrylic spray aluminium Spray acrílico aluminio › Spray acrylique aluminium	6
VITSAAM	Spray acrílico amarelo › Acrylic spray yellow Spray acrílico amarillo › Spray acrylique jaune	6
VITSAAZ	Spray acrílico azul › Acrylic spray blue Spray acrílico azul › Spray acrylique bleu	6
VITSABR	Spray acrílico branco › Acrylic spray white Spray acrílico blanco › Spray acrylique blanc	6
VITSABF	Spray acrílico branco perola › Acrylic spray pearle white Spray acrílico blanco perla › Spray acrylique blanc perle	6
VITSACA	Spray acrílico castanho › Acrylic spray brown Spray acrílico marrón › Spray acrylique marron	6
VITSACI	Spray acrílico cinzento › Acrylic spray grey Spray acrílico gris › Spray acrylique gris	6
VITSACR	Spray acrílico creme › Acrylic spray cream Spray acrílico crema › Spray acrylique crème	6
VITSALA	Spray acrílico laranja › Acrylic spray orange Spray acrílico naranja › Spray acrylique orange	6
VITSAPRB	Spray acrílico preto brilhante › Spray acrylique glossy black Spray acrílico negro brillante › Acrylic spray noir brillant	6
VITSAR	Spray acrílico rosa › Acrylic spray rose Spray acrílico rosa › Spray acrylique rose	6
VITSAVE	Spray acrílico verde menta › Acrylic spray mint green Spray acrílico verde menta › Spray acrylique vert menthe	6
VITSAVP	Spray acrílico verde primavera › Acrylic spray spring green Spray acrílico verde primavera › Spray acrylique vert printemps	6
VITSAVM	Spray acrílico vermelho › Acrylic spray red Spray acrílico vermelho rojo › Spray acrylique rouge	6
VITSAZ	Spray acrílico zinco › Acrylic spray zinc Spray acrílico cinc › Spray acrylique zinc	6
VITSADO	Spray acrílico dourado › Acrylic spray golden Spray acrílico dorado › Spray acrylique doré	6
VITSAPRA	Spray acrílico prateado › Acrylic spray silver Spray acrílico plateado › Spray acrylique argenté	6
VITSACO	Spray acrílico cobre › Acrylic spray copper Spray acrílico cobre › Spray acrylique cuivre	6
VITSAC	Spray acrílico cromado › Acrylic spray chrome Spray acrílico cromado › Spray acrylique chromé	6
VITSATPR	Spray acrílico alta temperatura preto › Acrylic spray high temperature black Spray acrílico alta temperatura negro › Spray acrylique haute température noir	6
VITSATAL	Spray acrílico alta temperatura alumínio › Acrylic spray high temperature aluminium Spray acrílico alta temperatura aluminio › Spray acrylique haute température aluminium	6
VITSAFVE	Spray acrílico fluorescente verde › Acrylic spray fluorescent green Spray acrílico fluorescente verde › Spray acrylique fluorescent vert	6
VITSAFAM	Spray acrílico fluorescente amarelo › Acrylic spray fluorescent yellow Spray acrílico fluorescente amarillo › Spray acrylique fluorescent jaune	6
VITSAFVM	Spray acrílico fluorescente vermelho › Acrylic spray fluorescent red Spray acrílico fluorescente rojo › Spray acrylique fluorescent rouge	6
VITSAP	Spray acrílico primário › Acrylic spray primary Spray acrílico primário › Spray acrylique primaire	6
VITSAV	Spray acrílico verniz › Acrylic spray varnish Spray acrílico barniz › Spray acrylique vernis	6
VITSATS	Spray acrílico tratamento de superfície › Spray acrílico surface treatment Spray acrílico tratamiento superficie › Acrylic spray traitement de surface	6

Total 168

Expositor de correntes - 12 ref.

Expositor de cadenas - 12 ref.

Chains exhibitor - 12 ref.

Présentoir de chaînes - 12 réf.

**Expositor de tornos**

Expositor de tornos

Bench vice display

Présentoir d'étau en fonte



Ref.	Composição › Composición Composition › Composition	Dim.	Qty.
VICZ2N	Corrente electro soldada zincada Cadena electrosoldada galvanizada Welded zinc chain Chaîne électro soudée zinguée	2 mm	20
VICZ2,5N	Corrente electro soldada zincada Cadena electrosoldada galvanizada Welded zinc chain Chaîne électro soudée zinguée	2,5 mm	20
VICZ3N	Corrente electro soldada zincada Cadena electrosoldada galvanizada Welded zinc chain Chaîne électro soudée zinguée	3 mm	20
VICZ4N	Corrente electro soldada zincada Cadena electrosoldada galvanizada Welded zinc chain Chaîne électro soudée zinguée	4 mm	20
VICZ5N	Corrente electro soldada zincada Cadena electrosoldada galvanizada Welded zinc chain Chaîne électro soudée zinguée	5 mm	20
VICZ6N	Corrente electro soldada zincada Cadena electrosoldada galvanizada Welded zinc chain Chaîne électro soudée zinguée	6 mm	20
VICZ7N	Corrente electro soldada zincada Cadena electrosoldada galvanizada Welded zinc chain Chaîne électro soudée zinguée	7 mm	20
VICZ8N	Corrente electro soldada zincada Cadena electrosoldada galvanizada Welded zinc chain Chaîne électro soudée zinguée	8 mm	20
VICZ9N	Corrente electro soldada zincada Cadena electrosoldada galvanizada Welded zinc chain Chaîne électro soudée zinguée	9 mm	20
VICZ10N	Corrente electro soldada zincada Cadena electrosoldada galvanizada Welded zinc chain Chaîne électro soudée zinguée	10 mm	20
VICZ11N	Corrente electro soldada zincada Cadena electrosoldada galvanizada Welded zinc chain Chaîne électro soudée zinguée	11 mm	20
VICZ13N	Corrente electro soldada zincada Cadena electrosoldada galvanizada Welded zinc chain Chaîne électro soudée zinguée	13 mm	20
	Total		240

Ref.	Composição › Composición Composition › Composition	Dim.	Qty.
VITB100	Torno de bancada › Bench vice Torno de banco › Étau en fonte	100mm	4
VITB125	Torno de bancada › Bench vice Torno de banco › Étau en fonte	125 mm	3
VITB150	Torno de bancada › Bench vice Torno de banco › Étau en fonte	150 mm	1
	Total		8

Expositor de prateleiras e acessórios completo

Expositor de estantes e acessórios completo

Accessories and shelves complete display

Présentoir d'étagères et accessoires complet



Ref.	Composição · Composition Composición · Composition	Dim.	Qtd.
VIPT20AL	Poleia p/ trilho alumínio › Bracket aluminium Cartela alumínio › Console pour crémaillère aluminium	20 cm	36
VIPT20BE	Poleia p/ trilho bege › Bracket beige Cartela bege › Console pour crémaillère beige	20 cm	36
VIPT20B	Poleia p/ trilho branco › Bracket white Cartela blanca › Console pour crémaillère blanc	20 cm	36
VIPT20P	Poleia p/ trilho preto › Bracket black Cartela negra › Console pour crémaillère noir	20 cm	36
VIPT30AL	Poleia p/ trilho alumínio › Bracket aluminium Cartela alumínio › Console pour crémaillère aluminium	30 cm	36
VIPT30BE	Poleia p/ trilho bege › Bracket beige Cartela bege › Console pour crémaillère beige	30 cm	36
VIPT30B	Poleia p/ trilho branco › Bracket white Cartela blanca › Console pour crémaillère blanc	30 cm	36
VIPT30P	Poleia p/ trilho preto › Bracket black Cartela negra › Console pour crémaillère noir	30 cm	36
VIPALB20100	Prateleira aglomerado laminado branco › Laminated shelf White Anaqueil aglomerado laminado branco › Étagère agglomérée laminé blanc	1,5 x 20 x 100 cm	6
VIPALB2080	Prateleira aglomerado laminado branco › Laminated shelf White Anaqueil aglomerado laminado branco › Étagère agglomérée laminé blanc	1,5 x 20 x 80 cm	6
VIPALB30100	Prateleira aglomerado laminado branco › Laminated shelf White Anaqueil aglomerado laminado branco › Étagère agglomérée laminé blanc	1,5 x 30 x 100 cm	6
VIPALB3080	Prateleira aglomerado laminado branco › Anaqueil aglomerado laminado branco Laminated shelf White › Étagère agglomérée laminé blanc	1,5 x 30 x 80 cm	6

Ref.	Composição › Composition Composición › Composition	Dim.	Qtd.
VIPALM20100	Prateleira aglomerado laminado mogno › Laminated shelf mahogany Anaquel aglomerado laminado caoba › Étagère agglomérée acajou	1,5 x 20 x 100 cm	6
VIPALM2080	Prateleira aglomerado laminado mogno › Laminated shelf mahogany Anaquel aglomerado laminado caoba › Étagère agglomérée acajou	1,5 x 20 x 80 cm	6
VIPALM30100	Prateleira aglomerado laminado mogno › Laminated shelf mahogany Anaquel aglomerado laminado caoba › Étagère agglomérée acajou	1,5 x 30 x 100 cm	6
VIPALM3080	Prateleira aglomerado laminado mogno › Laminated shelf mahogany Anaquel aglomerado laminado caoba › Étagère agglomérée acajou	1,5 x 30 x 80 cm	6
VIPALCS20100	Prateleira aglomerado laminado carv. silvestre › Laminated shelf wild oak Anaquel aglomerado laminado carv. silvestre › Étagère agglomérée chêne sauvage	1,5 x 20 x 100 cm	6
VIPALCS2080	Prateleira aglomerado laminado carv. silvestre › Laminated shelf wild oak Anaquel aglomerado laminado carv. silvestre › Étagère agglomérée chêne sauvage	1,5 x 20 x 80 cm	6
VIPALCS30100	Prateleira aglomerado laminado carv. silvestre › Laminated shelf wild oak Anaquel aglomerado laminado carv. silvestre › Étagère agglomérée chêne sauvage	1,5 x 30 x 100 cm	6
VIPALCS3080	Prateleira aglomerado laminado carv. silvestre › Laminated shelf wild oak Anaquel aglomerado laminado carv. silvestre › Étagère agglomérée chêne sauvage	1,5 x 30 x 80 cm	6
VIPALPR20100	Prateleira aglomerado laminado preto › Laminated shelf black Anaquel aglomerado laminado negra › Étagère agglomérée chêne noir	1,5 x 20 x 100 cm	6
VIPALPR2080	Prateleira aglomerado laminado preto › Laminated shelf black Anaquel aglomerado laminado negra › Étagère agglomérée chêne noir	1,5 x 20 x 80 cm	6
VIPALPR30100	Prateleira aglomerado laminado preto › Laminated shelf black Anaquel aglomerado laminado negra › Étagère agglomérée chêne noir	1,5 x 30 x 100 cm	6
VIPALPR3080	Prateleira aglomerado laminado preto › Laminated shelf black Anaquel aglomerado laminado negra › Étagère agglomérée chêne noir	1,5 x 30 x 80 cm	6
VIPALVM20100	Prateleira aglomerado laminado vermelho › Laminated shelf red Anaquel aglomerado laminado rojo › Étagère agglomérée chêne rouge	1,5 x 20 x 100 cm	6
VIPALVM2080	Prateleira aglomerado laminado vermelho › Laminated shelf red Anaquel aglomerado laminado rojo › Étagère agglomérée chêne rouge	1,5 x 20 x 100 cm	6
VIPALVM30100	Prateleira aglomerado laminado vermelho › Laminated shelf red Anaquel aglomerado laminado rojo › Étagère agglomérée chêne rouge	1,5 x 30 x 100 cm	6
VIPALVM3080	Prateleira aglomerado laminado vermelho › Laminated shelf red Anaquel aglomerado laminado rojo › Étagère agglomérée chêne rouge	1,5 x 30 x 80 cm	6
VIT1000AL	Trilho alumínio › Rack aluminium guide Guia alumínio › Crémaillère guide aluminium	100 cm	12
VIT1000BE	Trilho bege › Rack beige Guia bege › Guide Crémaillère guide bege	100 cm	12
VIT1000B	Trilho branco › Rack white guide Guia branco › Crémaillère guide blanc	100 cm	12
VIT1000P	Trilho preto › Rack black guide Guia negra › Crémaillère guide noir	100 cm	12
VIT2000AL	Trilho alumínio › Rack aluminium guide Guia alumínio › Rack aluminium guide Crémaillère guide aluminium	200 cm	12
VIT2000BE	Trilho bege › Rack beige guide Guia bege › Crémaillère guide bege	200 cm	12
VIT2000B	Trilho branco › Rack white guide Guia branco › Crémaillère guide blanc	200 cm	12
VIT2000P	Trilho preto › Rack black guide Guia negra › Crémaillère guide noir	200 cm	12
VIT300AL	Trilho alumínio › Rack aluminium guide Guia alumínio › Crémaillère guide aluminium	30 cm	12
VIT300BE	Trilho bege › Rack beige guide Guia bege › Crémaillère guide bege	30 cm	12
VIT300B	Trilho branco › Rack white guide Guia branco › Crémaillère guide blanc	30 cm	12
VIT300P	Trilho preto › Rack black guide Guia negra › Crémaillère guide noir	30 cm	12
VIT500AL	Trilho alumínio › Rack aluminium guide Guia alumínio › Crémaillère guide aluminium	50 cm	12
VIT500BE	Trilho bege › Rack beige guide Guia bege › Crémaillère guide bege	50 cm	12
VIT500B	Trilho branco › Rack white guide Guia branco › Crémaillère guide blanc	50 cm	12
VIT500P	Trilho preto › Rack black guide Guia negra › Crémaillère guide noir	50 cm	12
		Total	600

**Expositor de prateleiras
e acessórios - duplo encaixe**

 Expositor de estantes
e accesorios - doble encaje

**Shelves and accessories
display - doble fitting**

 Présentoir d'étagères
et accessoires - double prise

Duplo encaixe

Doble encaje

Double fitting

Double prise



Ref.	Composição Composición Composition Composition	Dim.	Qtd.
VIPTD17	Poleia para trilho duplo encaixe alumínio › Double bracket aluminium Cartela doble encaje aluminio › Console pour crémaillère double aluminium	17 cm	36
VIPTD17BE	Poleia para trilho duplo encaixe bege › Double bracket Beige Cartela doble encaje beige › Console pour crémaillère double beige	17 cm	36
VIPTD17B	Poleia para trilho duplo encaixe bege › Double bracket white Cartela doble encaje beige › Console pour crémaillère double blanc	17 cm	36
VIPTD17P	Poleia para trilho duplo encaixe preta › Double bracket black Cartela doble encaje negra › Console pour crémaillère double noir	17 cm	36
VIPTD27AL	Poleia para trilho duplo encaixe alumínio › Double bracket aluminium Cartela doble encaje aluminio › Console pour crémaillère double aluminium	27 cm	36
VIPTD27BE	Poleia para trilho duplo encaixe bege › Double bracket Beige Cartela doble encaje beige › Console pour crémaillère double beige	27 cm	36
VIPTD27B	Poleia para trilho duplo encaixe branco › Double bracket white Cartela doble encaje blanco › Console pour crémaillère double blanc	27 cm	36
VIPTD27P	Poleia para trilho duplo encaixe preta › Double bracket black Cartela doble encaje negra › Console pour crémaillère double noir	27 cm	36
VIPALB20100	Prateleira aglomerado laminado branco › Laminated shelf White Anaquel aglomerado laminado blanco › Étagère agglomérée laminé blanc	1,5 x 20 x 100 cm	6
VIPALB2080	Prateleira aglomerado laminado branco › Laminated shelf White Anaquel aglomerado laminado blanco › Étagère agglomérée laminé blanc	1,5 x 20 x 80 cm	6
VIPALB30100	Prateleira aglomerado laminado branco › Laminated shelf White Anaquel aglomerado laminado blanco › Étagère agglomérée laminé blanc	1,5 x 30 x 100 cm	6
VIPALB3080	Prateleira aglomerado laminado branco › Laminated shelf White Anaquel aglomerado laminado blanco › Étagère agglomérée laminé blanc	1,5 x 30 x 80 cm	6
VIPALM20100	Prateleira aglomerado laminado branco › Laminated shelf mahogany Anaquel aglomerado laminado blanco › Étagère agglomérée laminé acajou	1,5 x 20 x 100 cm	6

Ref.	Composição Composition	Composición Composition	Dim.	Qty.
VIPALM2080	Prateleira aglomerado laminado mogno › Laminated shelf mahogany Anaquel aglomerado laminado caoba › Étagère agglomérée acajou		1,5 x 20 x 80 cm	6
VIPALM30100	Prateleira aglomerado laminado mogno › Laminated shelf mahogany Anaquel aglomerado laminado caoba › Étagère agglomérée acajou		1,5 x 30 x 100 cm	6
VIPALM3080	Prateleira aglomerado laminado mogno › Laminated shelf mahogany Anaquel aglomerado laminado caoba › Étagère agglomérée acajou		1,5 x 30 x 80 cm	6
VIPALCS20100	Prateleira aglomerado laminado carv. silvestre › Laminated shelf wild oak Anaquel aglomerado laminado carv. silvestre › Étagère agglomérée chêne sauvage		1,5 x 20 x 100 cm	6
VIPALCS2080	Prateleira aglomerado laminado carv. silvestre › Laminated shelf wild oak Anaquel aglomerado laminado carv. silvestre › Étagère agglomérée chêne sauvage		1,5 x 20 x 80 cm	6
VIPALCS30100	Prateleira aglomerado laminado carv. silvestre › Laminated shelf wild oak Anaquel aglomerado laminado carv. silvestre › Étagère agglomérée chêne sauvage		1,5 x 30 x 100 cm	6
VIPALCS3080	Prateleira aglomerado laminado carv. silvestre › Laminated shelf wild oak Anaquel aglomerado laminado carv. silvestre › Étagère agglomérée chêne sauvage		1,5 x 30 x 80 cm	6
VIPALPR20100	Prateleira aglomerado laminado preto › Laminated shelf black Anaquel aglomerado laminado negra › Étagère agglomérée chêne noir		1,5 x 20 x 100 cm	6
VIPALPR2080	Prateleira aglomerado laminado preto › Laminated shelf black Anaquel aglomerado laminado negra › Étagère agglomérée chêne noir		1,5 x 20 x 80 cm	6
VIPALPR30100	Prateleira aglomerado laminado preto › Laminated shelf black Anaquel aglomerado laminado negra › Étagère agglomérée chêne noir		1,5 x 30 x 100 cm	6
VIPALPR3080	Prateleira aglomerado laminado preto › Laminated shelf black Anaquel aglomerado laminado negra › Étagère agglomérée chêne noir		1,5 x 30 x 80 cm	6
VIPALVM20100	Prateleira aglomerado laminado vermelho › Laminated shelf red Anaquel aglomerado laminado rojo › Étagère agglomérée chêne rouge		1,5 x 20 x 100 cm	6
VIPALVM2080	Prateleira aglomerado laminado vermelho › Laminated shelf red Anaquel aglomerado laminado rojo › Étagère agglomérée chêne rouge		1,5 x 20 x 80 cm	6
VIPALVM30100	Prateleira aglomerado laminado vermelho › Laminated shelf red Anaquel aglomerado laminado rojo › Étagère agglomérée chêne rouge		1,5 x 30 x 100 cm	6
VIPALVM3080	Prateleira aglomerado laminado vermelho › Laminated shelf red Anaquel aglomerado laminado rojo › Étagère agglomérée chêne rouge		1,5 x 30 x 80 cm	6
VIT1000AL	Trilho duplo encaixe alumínio › Double rack aluminium Guia doble encaje aluminio › Crémaillère double aluminium		100 cm	12
VIT1000BE	Trilho duplo encaixe bege › Double rack beige Guia doble encaje beige › Crémaillère double beige		100 cm	12
VIT1000B	Trilho duplo encaixe branco › Double rack white Guia doble encaje blanco › Crémaillère double blanc		100 cm	12
VIT1000P	Trilho duplo encaixe preto › Double rack black Guia doble encaje negra › Crémaillère double noir		100 cm	12
VIT2000AL	Trilho duplo encaixe alumínio › Double rack aluminium Guia doble encaje aluminio › Crémaillère double aluminium		200 cm	12
VIT2000BE	Trilho duplo encaixe bege › Double rack beige Guia doble encaje beige › Crémaillère double beige		200 cm	12
VIT2000B	Trilho duplo encaixe branco › Double rack white Guia doble encaje blanco › Crémaillère double blanc		200 cm	12
VIT2000P	Trilho duplo encaixe preto › Double rack black Guia doble encaje negra › Crémaillère double noir		200 cm	12
VIT300AL	Trilho duplo encaixe alumínio › Double rack aluminium Guia doble encaje aluminio › Crémaillère double aluminium		30 cm	12
VIT300BE	Trilho duplo encaixe bege › Double rack beige Guia doble encaje beige › Crémaillère double beige		30 cm	12
VIT300B	Trilho duplo encaixe branco › Double rack white Guia doble encaje blanco › Crémaillère double blanc		30 cm	12
VIT300P	Trilho duplo encaixe preto › Double rack black Guia doble encaje negra › Crémaillère double noir		30 cm	12
VIT500AL	Trilho duplo encaixe alumínio › Double rack aluminium Guia doble encaje aluminio › Crémaillère double aluminium		50 cm	12
VIT500BE	Trilho duplo encaixe bege › Double rack beige Guia doble encaje beige › Crémaillère double beige		50 cm	12
VIT500B	Trilho duplo encaixe branco › Double rack white Guia doble encaje blanco › Crémaillère double blanc		50 cm	12
VIT500P	Trilho duplo encaixe preto › Double rack black Guia doble encaje negra › Crémaillère double noir		50 cm	12
			Total	600

Reserva-se o direito de proceder a alterações de produtos, características e imagens sem aviso prévio.
Salvuarda-se a possibilidade de erros de impressão. Fevereiro 2018.

Se reserva el derecho de hacer cambios a los productos, las características y las imágenes sin previo aviso.
Se salvaguarda la posibilidad de errores en la impresión. Febrero 2018.

We reserve the right to change the products, features and images without previous notice.
Printing errors are duly safeguarded. February 2018.

Nous réservons le droit de procéder à des modifications des produits, caractéristiques et images sans préavis.
Sous réserve de possibilité d'erreurs d'impression. Février 2018.

**FERRAMENTAS
MANUAIS E ACESSÓRIOS**

HERRAMIENTAS
MANUALES Y ACCESORIOS

**MECHANICAL TOOLS
AND ACCESSORIES**

OUTILS MÉCANIQUES
ET ACCESSOIRES