

# SMALL TRACTOR LINKAGE CATALOGUE

## LINKAGE ASSEMBLIES & PARTS

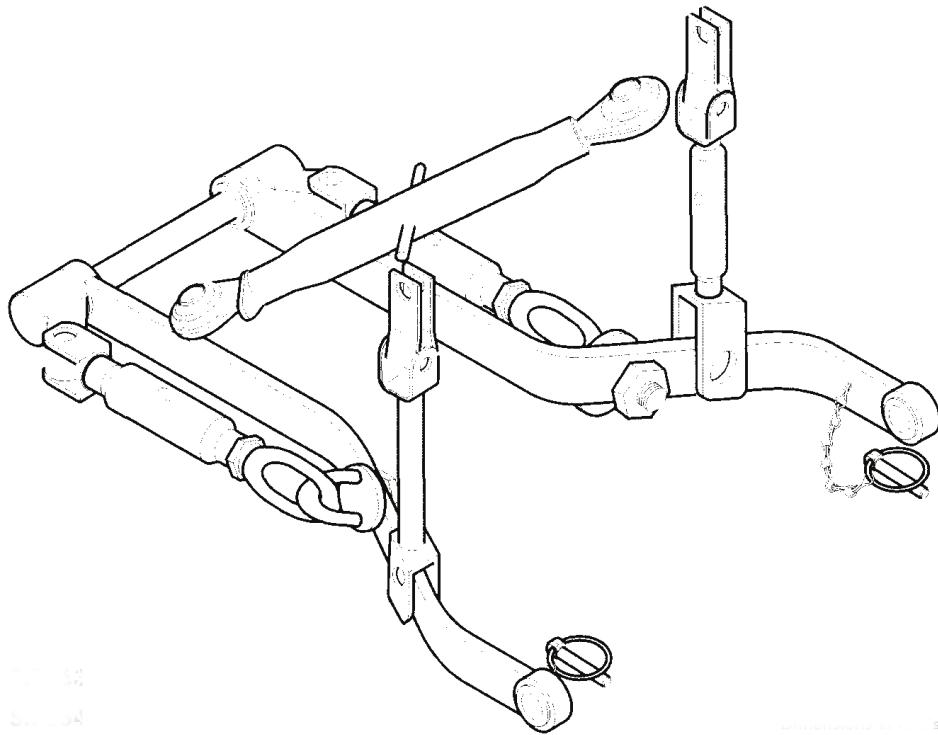

---

**DISCOUNT TRACTOR PARTS**

**Ph 0800 872272**

[www.discounttractorparts.co.nz](http://www.discounttractorparts.co.nz)   [sales@discounttractorparts.co.nz](mailto:sales@discounttractorparts.co.nz)

All prices in this catalogue are plus GST & subject to change

# Rear Linkage Three Point Linkage Kits

For narrow track low hp tractors.



**Iskei up to 20hp \$265**



**Suits Kubota up to 20hp  
Kit as shown \$295**

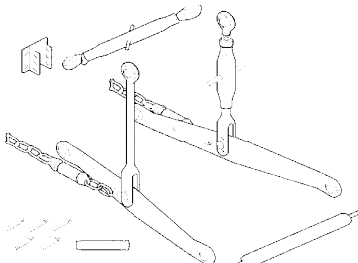

**Multi Fit up to 25hp  
Kit as shown \$375**

## Individual parts available

**Levelling Box Link**  
LK28 \$49.50  
Cat 0 (16mm ball ID)  
Centre tube length 187mm



**Fixed Length Link**  
LK33 \$24  
Hole centre to centre length 300mm  
Pin hole diameters 15.7mm

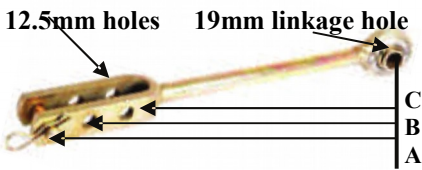

**Levelling Box Link**  
Tube length 140mm  
Pin Holes C/C 265 min  
Clevis widths 22mm & 42mm LK 33A \$30

12.5mm holes 19mm linkage hole

**Fixed Length Links**

Pt No	A	B	C	Price
LK 34	400	360	325	\$36
LK 35	450	425	400	\$36

**Levelling Box Links**



Pt No	Tube length	Ball size	Price
LK29	187	19mm	\$45.00
LK30	237	19mm	\$48.00
LK31	287	19mm	\$45.00

**Linkage drawbars**

LK 17 Cat one 550mm inside length \$65.00 (5 holes)

LK 18 Cat one 660mm inside length \$68.00 (7 holes)



Prices plus GST & subject to change

# Lower Lift Arms

Pt No	A	B	C	D	Cat	Price
LK37	495	160			1	\$60
LK38	700	160			1	\$50
LK40	545	235	185		1	\$45
LK41	600	350	305	215	1	\$65
LK42	650	375	330	215	1	\$52.50
LK45	As per picture				1	\$85

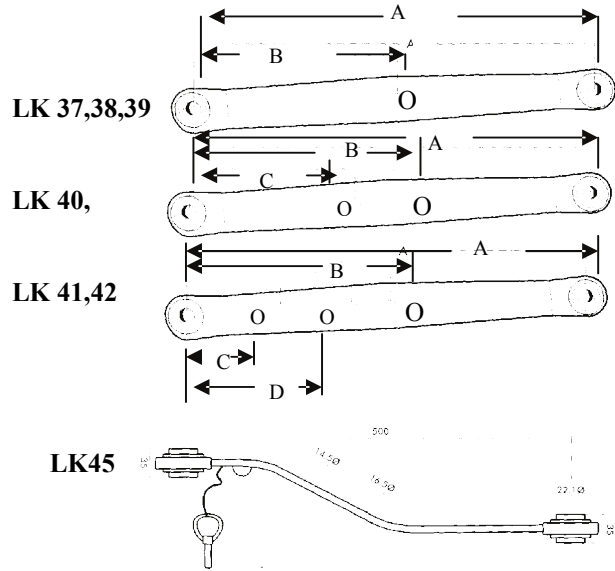

## Check Chains

LK32 \$65

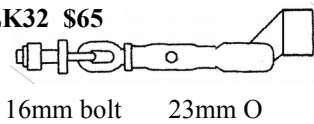

16mm bolt 23mm O



LK25 Universal check chain \$38.50

LK26 \$78



Adj. range 490 - 580

LK27 \$50

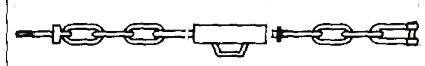

Adj. range 285 - 360



LK24 Adj. 650mm to 890mm \$32.75

## Top Links & Mounts

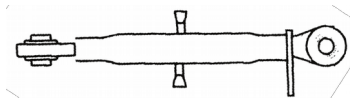

Pt No	Adj Range	Cat	Price
LK1	327 - 470	0	\$40
LK2	420 - 630	1	\$48
LK3	520 - 724	1	\$48
LK3A	520 - 724	1/2	\$48
LK4	620 - 840	1	\$48
LK4A	620 - 840	1/2	\$48

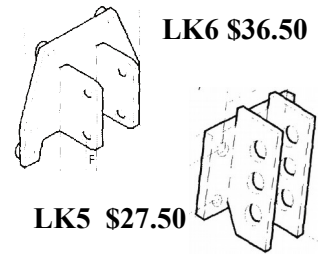

LK6 \$36.50

LK5 \$27.50

## Weld On Ball Ends



Pt No	B	C	D	E	Cat	Price
LK19F	30	52	45	13	1	\$12.90
LK19R	30	65	45	15	1	\$12.90
LK20F	62	71	35	16	1	\$16.50

Pt No	Hole	O D	Width	Price
LK21	22.0	67	12.5	\$24.81
LK22	25.4	80	19	\$28.11
LK23	28.6	80	19	\$28.11

Dimensions in mm.

Prices plus gst and subject to

# Discount Tractor Parts

Ph 0800 872272

## IMPLEMENT PINS

10% discount on orders of 10 or more pins (assorted size)

B75	Cat 1	Top Link	19x98mm	\$4.00
B215	Cat 1	Lower	22x105mm	\$7.30
B81	Cat 2	Top Link	25x105mm	\$8.00
B216	Cat 2	Lower	28x105mm	\$12.00
B2597	Cat 3	Top Link	32x115mm	\$15.00
B3517	Cat 3	Lower	36x203mm	\$26.00



## Drawbar Pins

B3077	12.7x90mm	\$5.00
B3078	16x108mm	\$5.30
B404	19x160mm	\$6.60
B405	22x160mm	\$9.45
B410	25x160mm	\$10.00
B412	28x160mm	\$16.50
B415	32x160mm	\$18.75
B417	38x185mm	\$28.50
B7417	50x185mm	\$45.00

## Stepped implement pins

B2971	Cat 1 / 2	top link	\$12.25
B100	Cat 1 / 2	lower link	\$12.25

## HOSE CLIPS-

Max ID	Price
16mm	\$1.50
19mm	\$1.80
27mm	\$2.00
32mm	\$2.20
38mm	\$2.40
44mm	\$3.00
51mm	\$3.20
57mm	\$3.40
70mm	\$3.80
76mm	\$4.00
102mm	\$5.00



Stainless Steel Construction

20 % discount on orders of 20 or more clips assorted size

## LINCH PINS

pin diam
B4 4.5 mm
B2 6mm
B3 8mm
B6 11mm

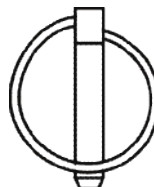

\$1.00 ea , 3 for \$2.00 , 10 for \$5.00 (assorted)

## D SHACKLES Zinc Plated,

Pin size	Price
6mm	\$1.00
8mm	\$1.20
10mm	\$1.50
12mm	\$2.50
16mm	\$5.00
19mm	\$7.00
25mm	\$12.00



## R CLIPS



	wire diam	suit shaft diam	price each
B8	2mm	6-11mm	0.50c
B9	2.5mm	8-12mm	0.50c
B10	3mm	10-12mm	0.50c
B12	4mm	12-22mm	1.00
B13	5mm	16-27mm	1.00
B14	6mm	19-32mm	2.50
B15	7mm	25-38mm	3.00

## SHAFT LOCKING PIN

B8100 6mm pin  
 B6100 8mm pin  
 B6101 10mm pin \$2.00 ea  
 10 % discount on 10 or more lock pins assorted sizes.

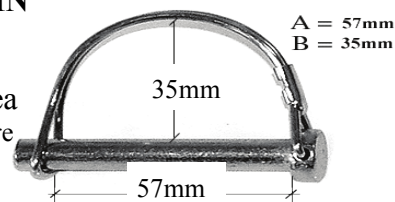

## IMPLEMENT MOUNTING PINS



B198	cat 1	19mm thread	\$7.00
B200	cat 1	22mm thread	\$7.00
B197	cat 2	19mm thread	\$10.00
B202	cat 2	22mm thread	\$10.00

Other sizes available

## TOP LINKS

Std duty Cat 1 & 2  
 avail \$424 ea



## LINKAGE DRAWBARS

Cat 1 & 2 available \$63 ea



Also available Large range of lock collars , clevis pins , bushes , linkage balls , tow balls.



Prices plus gst and subject to change

# Discount Tractor Parts Pins & Accessories

## Tractor and implement pin selection

Category	top link	lower link
One	19mm	22mm
Two	25.4mm	28mm
Three	32mm	

### Implement Mounting Pins



32mm usable thread

### Linkage pins



Pin Diam	Usable length	Price	Order no	Mount thread	Pin Cat	Price	Order no
16mm	51mm	\$3.12	2107	3/4" UNF	1	\$7.00 *	198
16mm	76mm	\$3.60 *	1640	3/4" UNF	2	\$11.00	197
19mm	57mm	\$5.80	2747	7/8" UNF	1	\$7.00 *	200
19mm	76mm	\$5.00	73	7/8" UNF	2	\$11.00*	202
19mm	85mm	\$4.00 *	75	7/8" UNF	3	\$21.00	2520
19mm	98mm	\$4.00 *	74	1" UNF	1	\$12.00	101
19mm	120mm	\$6.20	77	1" UNF	2	\$12.00*	102
22mm	90mm	\$7.80	54	1" UNF	3	\$21.00	2521
22mm	105mm	\$7.30 *	215	1 1/8" UNF	1	\$11.00	201
25.4mm	51mm	\$8.60	2593	1 1/8" UNF	2	\$14.00	203
25.4mm	63mm	\$7.30	7593	1 1/8" UNF	3	\$21.00	2522
25.4mm	76mm	\$7.80	1200				
25.4mm	88mm	\$7.80 *	76				
25.4mm	115mm	\$8.00 *	81				
25.4mm	136mm	\$12.00	80				
25.4mm	105mm	\$12.00	216				
32mm	115mm	\$15.00 *	2597				
36.5mm	127mm	\$19.50 *	2517				
36.5mm	203mm	\$26.00	3517				

\* denotes commonly used pins

### Dual category Implement



### Bolt in 1/2 lower link

Mounting	Price	Order no
25.4mm Mount hole	\$12.00 *	205
28.6mm Mount hole	\$15.00	206

### Dual Category Linkage Pins



### Weld in 1/2 lower link pin

Pin type	Price	Order no.
Cat 1/2 top link	\$12.50 *	2971
Cat 1/2 lower link	\$12.50 *	100
Cat 1/2/3 lower link	\$20.00	7343

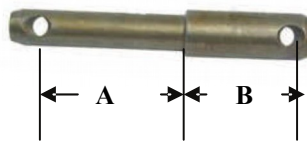

A	B	Price	Order no
90	55	\$11	210

Discount Tractor Parts Ph 0800 872272

E mail sales@discounttractorparts.co.nz

Www.discounttractorparts.co.nz



# SLASHER BOXES



40 HP \$314  
75 HP \$540  
130 HP \$1051

Boxes come complete with output drive hub.



## OVER RUN CLUTCH

40 HP \$132

Other sizes available

## SLIP CLUTCH

40 HP \$206

60 HP \$245

100 HP \$362

## DRIVESHAFTS

Standard 1mtr length

16 HP \$186      21 HP \$207  
35 HP \$209      64 HP \$304  
105 HP \$394    120 HP \$774 Star

Fitted with slip clutch

35 HP \$367      64 HP \$460

With wide angle joint

35 HP \$734      65 HP \$840

75 HP \$1173 star tube

Also available with over run clutch

## SLASHER BLADES

Straight blades

DTP 6001 275mm x 13mm \$27.00

DTP 50 428mm x 13mm \$41.00

Step blades

DTP 6002 360mm x 13mm \$30.50

DTP 6000 485mm x 10mm \$39.00

Bolt Kit includes bush \$12.50 (58mm bolt)

Bolt kit (with 76mm bolt) \$16.50

HD6999 Heavy duty stepped blade :-

460mm x 16mm \$67.00 Bush kit \$16.50

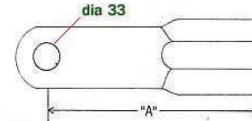
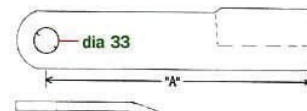

## POST HOLE BORER

Mechanical Boxes

35 hp \$475

50 hp \$499

75 hp \$740



Hydraulic Drive Boxes

50 hp \$739

Replacement parts available

Cutters \$25.00 pr

Tungsten cutter \$53 ea

Lead screw \$48.00



## AUGERS

Double cut entry

100 mm dia \$480

150 mm dia \$527

200 mm dia \$567

228 mm dia \$567

254 mm dia \$567

300 mm dia \$567

380mm dia \$700

450mm dia \$946

## BUILD YOUR OWN KITS

Slasher includes

\* 40 hp incl box, drive shaft & 2 blades with bolt kits \$580

\* 75 hp incl box, drive shaft & 4 blades with bolt kits \$950

\* 130 hp incl box, drive shaft, 4 heavy duty, blades, kits & slip clutch \$1860

Other options available

Post hole borer includes

50 hp box, 2.5 mtr drive shaft & 228 or 300 auger \$1195

75 hp box, 2.5 mtr drive shaft & 450 or 610 auger \$1895

Other options available

DISCOUNT TRACTOR PARTS

PH 0800 872 272

Prices plus gst and subject to change

# SEAT SPECIALS

Top of the line suspension seats with extra thick padding, weight adjustment, angle base option & base slider RRP \$194

Our Price \$144

Choice of wrap round or flat back back rest



Low Clearance  
Suspension Seat  
Suit machinery &  
Forkhoist \$325



High Back Deluxe  
\$160.  
Armrest kit \$95

Seat Pan

Extra Padded  
High Back \$160



Standard Seat Pans

390 mm wide \$118

485 mm wide \$125

Slider Rails \$45set



Discount Tractor Parts Ph 0800 872272

Email [sales@discounttractorparts.co.nz](mailto:sales@discounttractorparts.co.nz) All prices plus gst and subject to change  
Some upholstery patterns may alter to those shown