

ORAC[®]
DECOR

FREE YOUR
PERSONALITY

ORAC[®]
D E C O R

FREE YOUR *PERSONALITY*

en

Show who you are.

Whoever you are, wherever you live, you are you and you want to show it. In your house, in your environment, in the place you call home. Find your own style and put your personality in the spotlight. Whether you prefer a masterful modern or character-filled classic style, this collection of original skirting boards, elegant cornices, stylish panel mouldings and innovative indirect lighting will transform your house into a dream home. A unique place that says who you are and how you approach life. But enough about us: let's talk about you.

it

Mostra chi sei.

Chiunque tu sia, qualunque sia il luogo in cui vivi, tu sei tu e lo vuoi dimostrare. Nel tuo ambiente, nel posto che consideri come la tua casa. Vuoi affermare il tuo stile e mettere in risalto la tua personalità. Completamente moderna o tipicamente classica questa collezione di originali battiscopa, eleganti cornici per parete, innovative cornici per soffitto e per l'illuminazione indiretta, trasformerà la tua casa in un luogo da sogno e di carattere. Un ambiente unico che racconta la tua personalità e il tuo modo di vivere la vita. Ma basta parlare di noi. Parliamo di te.

pt

Mostre quem é.

Quem quer que você seja, onde quer que viva, você é e vai querer mostrá-lo. Na sua casa, no seu espaço, no local a que chama casa. Encontre o seu estilo e dê destaque à sua personalidade. Quer prefira um estilo moderno poderoso ou um estilo clássico repleto de carácter, esta coleção de rodapés originais, sancas elegantes, perfis modernos e sancas de iluminação indireta inovadoras, irá transformar a sua casa numa casa de sonho cheia de personalidade. Um lugar único que transmite quem você é e como encara a vida. Já falámos o suficiente sobre nós: vamos falar de si.

ro

Arata cine esti.

Oricine ai fi, oriunde locuiesti, tu esti tu si vrei s-o arati. In casa ta, in mediul tau, in locul pe care il numesti «acasa». Gaseste-ti stilul si pune-ti personalitatea in lumina reflectoarelor. Indiferent daca preferi un stil clasic modern sau unul clasic grandios, aceasta colectie de plinte, cornise elegante, paneluri si inovative scafe de lumina indirecta, va transforma casa ta intr-o casa de vis care izbucneste cu caracter. Un loc unic care spune cine esti si cat apreciezi viata. Dar destul despre noi: sa vorbim despre tine!

cz

Ukažte, kdo jste.

Ať už jste kdokoliv, kdekoliv žijete, Vy jste Vy a chcete to také ukázat. Ve Vašem domě, ve Vašem prostředí, na místě, které nazýváte svým domovem. Najděte svůj vlastní styl a zaměřte se na svou osobnost. Je jedno, zda preferujete mistrovsky moderní nebo klasický styl, plný charakteru. Tato kolekce originálních podlahových lišt, elegantních stropních lišt, stylových lemovacích lišt a inovativních profilů pro nepřímé osvětlení přemění Váš dům ve snový domov prosycený charakterem. Jedinečné místo, které řekne, kdo jste a o Vašem přístupu k životu. Ale už dost o nás, pojďme mluvit o Vás.



Content

en

06 Your style, your space.
 08 Hall
 18 Living room
 32 Kitchen
 44 Bathroom
 54 Bedroom
 62 Projects
 80 Materials
82 Product Overview
 84 Cornice Mouldings
 104 Panel Mouldings
 114 Skirting
 126 Indirect Lighting
 138 Deco Elements
 154 The Perfect Finish
 156 Flexible Products

it

06 Il tuo stile, il tuo spazio.
 08 Ingresso
 18 Soggiorno
 32 Cucina
 44 Bagno
 54 Camera da letto
 62 Progetti
 80 Materiali
82 Sommario Prodotti
 84 Cornici Soffitto
 104 Cornici Parete
 114 Battiscopa
 126 Illuminazione Indiretta
 138 Elementi Decorativi
 154 La Finitura Perfetta
 156 Profili Flessibili

pt

06 O seu espaço, ao seu estilo.
 08 Hall
 18 Sala
 32 Cozinha
 44 Casa de Banho
 54 Quarto
 62 Projetos
 80 Materiais
82 Resumo de Produto
 84 Sancas
 104 Perfis
 114 Rodapés
 126 Iluminação Indireta
 138 Elementos Decorativos
 154 O Acabamento Perfeito
 156 Produtos Flexíveis

ro

06 Stilul tau, spatiul tau.
 08 Hol
 18 Sufragerie
 32 Bucatarie
 44 Baie
 54 Dormitor
 62 Proiecte
 80 Materiale
82 Rezumatul Produselor
 84 Cornise
 104 Brauri
 114 Plinte
 126 Iluminat Indirect
 138 Elemente Decorative
 154 Finisarea Perfecta
 156 Produse Flexibile

cz

06 Váš styl, Váš prostor.
 08 Hala
 18 Obývací místnost
 32 Kuchyně
 44 Koupelna
 54 Ložnice
 62 Projekty
 80 Materiály
82 Přehled Produktů
 84 Stropní Lišty
 104 Lemovací Lišty
 114 Podlahové Lišty
 126 Nepřímé Osvětlení
 138 Dekorativní Prvky
 154 Perfektní Zakončení
 156 Ohebné Produkty

Your style, your space.

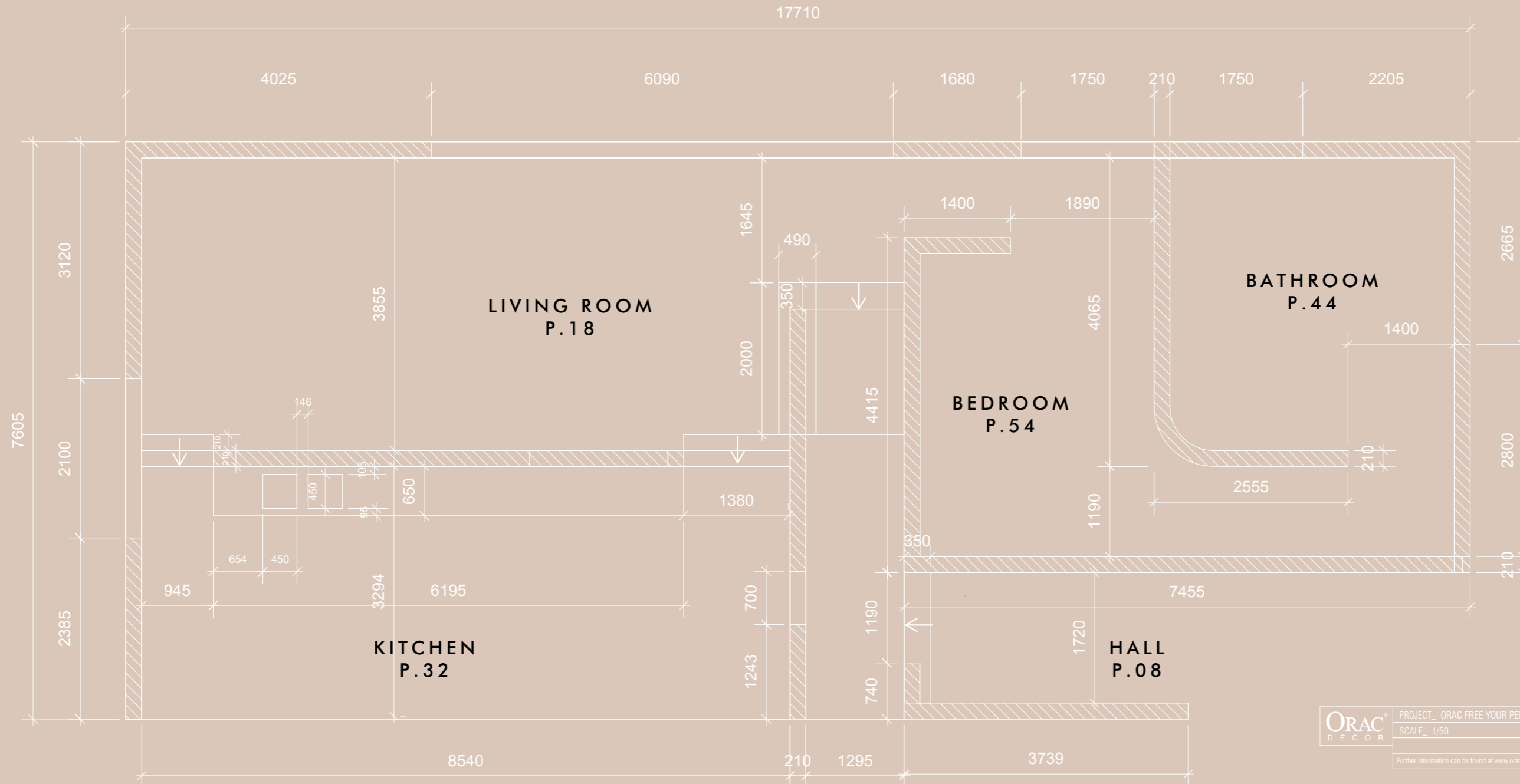

ORAC [®] DECOR	PROJECT_ ORAC FREE YOUR PERSONALITY HOUSE	Birkofstrast 82 8400 Doornik, België T +32 (0)59 80 32 52 F +32 (0)59 80 28 10 info@oracdecor.com www.oracdecor.com
	SCALE_ 1/50	
Further information can be found at www.oracdecor.com		Version 1.0

en

Your style, your space.

6

From living room to bedroom, kitchen to bathroom: be inspired by our projects and create your own dream world. The only limit is your own creativity. Welcome to your interior.

it

Il tuo stile, il tuo spazio.

Dal soggiorno alla camera da letto, dalla cucina al bagno: lasciatevi ispirare dalle nostre idee e crea il tuo mondo ideale. L'unico limite è la tua creatività. Benvenuto nella tua casa.

pt

O seu espaço, ao seu estilo.

Desde a sala ao quarto, da cozinha à casa de banho: deixe-se inspirar pelos nossos projetos e crie o seu próprio mundo de sonho. O único limite é a sua própria criatividade. Seja bem-vindo ao seu interior.

ro

Stilul tau, spatiul tau.

Din sufragerie in dormitor, din bucatarie in baie: fii inspirat de proiectele noastre si creeaza-ti propria ta lume de vis. Singura limita este propria ta creativitate. Bun-venit in interiorul tau.

cz

Váš styl, Váš prostor.

Od obývací místnosti po ložnici, od kuchyně po koupelnu: inspiřte se našimi projekty a vytvořte svůj vlastní snový svět. Jediným limitem je jen Vaše kreativita. Vítejte ve vašem interiéru.

7

9:00am *In the*
HALL



A BITE OF
PERSONALITY



Light in the darkness.

Create your own
unique fixtures.



2 C383



1 C380 p.131

2 C383 p.131

3 SX181 p.120

4 C380 p.131

5 C991 p.89

6 C357 p.128

7 DX157-2300 p.118

it

Luce nell'oscurità.
Crea il tuo spazio!

pt

Luz na escuridão.
Crie a sua iluminação exclusiva.

ro

Lumina in întuneric.
Creeaza-ti propriile corpuri
unice!

cz

Světlo ve tmě.
Vytvořte svou vlastní instalaci.

HALL



- 1 P8030 p.106
- 2 P4020 p.106
- 3 SX118 p.120
- 4 C339 p.90

HALL





it

Trasforma le nude pareti in un'attrazione per lo sguardo.

pl

Transforme as suas paredes despidas com um design atraente.

ro

Transforma zidurile goale in inaltimi atractive.

cz

Přeměňte holé stěny v přitažlivé.

HALL

- 1 DX121-2300 p.112
- 2 SX155 p.119
- 3 D503 p.151
- 4 SX122 p.118
- 5 P8030 p.106
- 6 C339 p.90



Transform bare walls into eye-catching elevations.

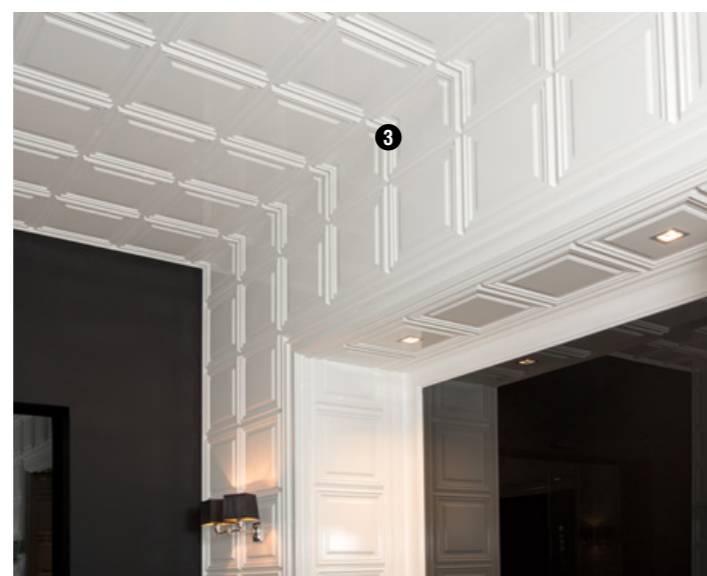

Who said your hall needs to be a dark and boring space?

HALL



1 C381

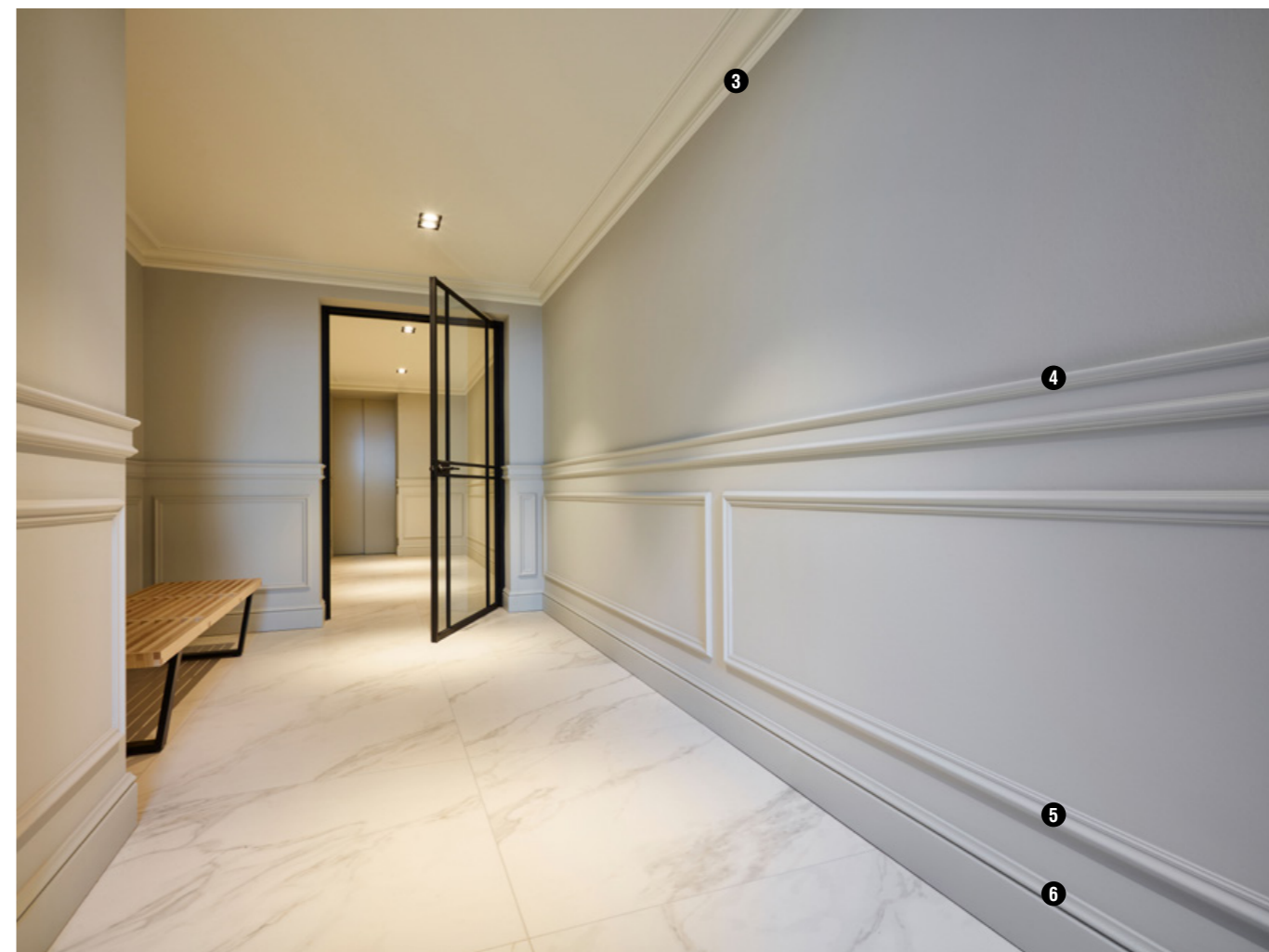

it

Il tuo ingresso è uno spazio buio e noioso? Ci sono infinite possibilità!

pl

Quem disse que o seu hall precisa ser um espaço escuro e aborrecido?

ro

Cine spune ca holul tau trebuie sa fie un spatiu intunecos si plictisitor?

cz

Kdo řekl, že Vaše předsíň musí být tmavé a nudné místo?

1 C381 p.131

2 SX181 p.120

3 C341 p.87

4 DX121-2300 p.112

5 P8030 p.106

6 SX118 p.120



PERSONALITY
IS YOUR BEST OUTFIT

9:00pm *In the*
LIVING ROOM



1

1

2



3

4

5

6

- 1 C380 p.131
- 2 SX181 p.120
- 3 C902 p.129
- 4 P8020 p.106
- 5 P8050 p.108
- 6 SX118 p.120



2 SX181

LIVING ROOM

LIVING ROOM

it

Una combinazione vincente. Inserisci l'illuminazione indiretta all'interno della cornice per dare un effetto di grande ambiente.

pt

Uma combinação vencedora. Coloque luz indireta por debaixo da sanca para conseguir um efeito mais espaçoso.

ro

O combinație castigatoare! Pune sfața de lumina indirectă sub cornișă pentru un efect de mai mult spațiu.

cz

Vítězná kombinace. Umístěte nepřímé osvětlení pod vaší stropní lištu pro vytvoření efektu většího prostoru.

- ❶ C393 p.90
- ❷ C383 p.131
- ❸ SX181 p.120
- ❹ C990 + 2XP9900 p.92
- ❺ C381 p.131



❷ C383

A winning combination.

Place your indirect lighting under your cornice for a more spacious effect.



❺ C381

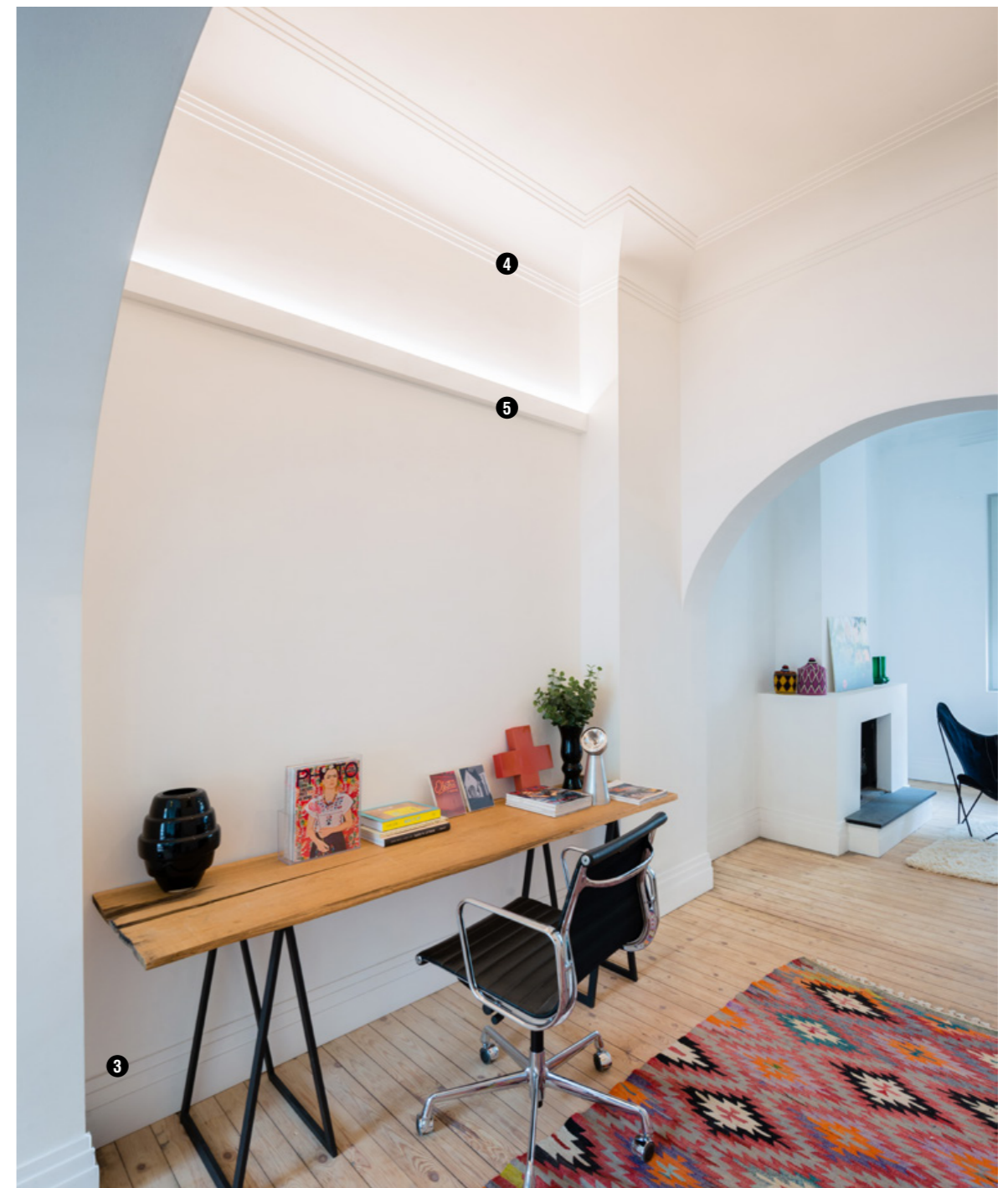

❸

❹

❺



it
La parete come una tela.
Trasforma la parete in un'opera
d'arte con le nostre cornici.

pt
Use as suas paredes como
uma tela.
Os nossos perfis irão
transformar as suas paredes
numa obra de arte.

ro
Utilizeaza peretele ca pe o
panza.
Panourile noastre iti vor
transforma peretele intr-o opera
de arta.

cz
Použijte vaši stěnu jako plátno.
Naše lemovací lišty přemění
vaši stěnu v umělecké dílo.



Our panel
mouldings will
transform your
wall into a
work of art.

Use
your
wall
as a
blank
canvas.



- 1 P9010 p.107
- 2 P4020 p.106
- 3 P8020 p.106
- 4 SX118 p.120
- 5 PX103 p.110
- 6 SX155 p.119
- 7 C219 p.93

LIVING ROOM





LIVING ROOM



- ❶ P8030 p.106
- ❷ C344 p.95
- ❸ P8020 p.106
- ❹ P4020 p.106
- ❺ SX118 p.120

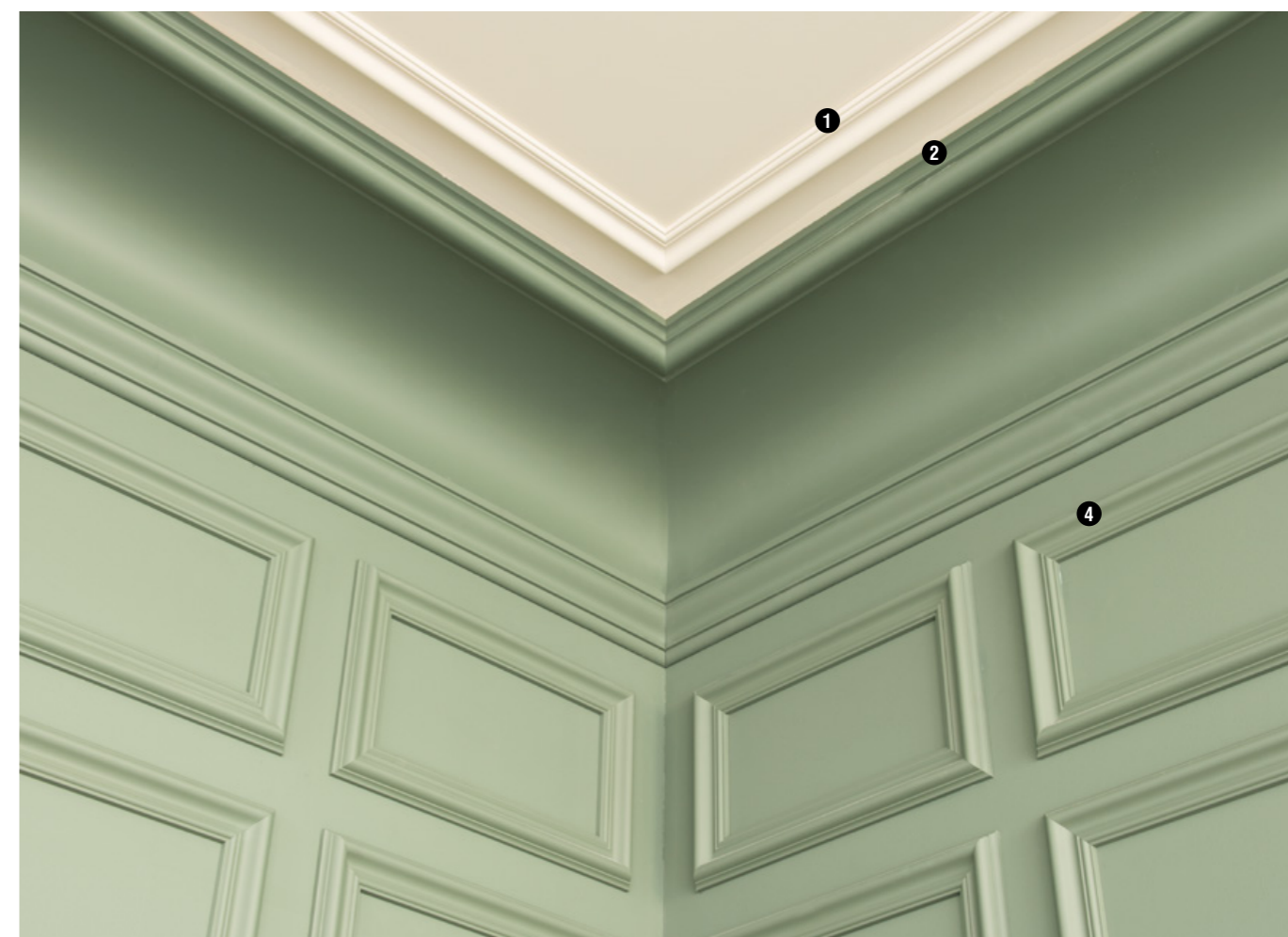

Instant class.

Panelling will take your space to the next level.

it
Eleganza spontanea.
Un discreto lambris dà risalto allo spazio.

pt
Classe instantânea.
Os Painéis Decorativos irão elevar o seu espaço ao próximo nível.

ro
Clasa instantanee.
Panourile vor duce spatiul tau catre nivelul urmator.

cz
Rychlá přeměna.
Stěnové obložení pozvedne vaši stěnu o další úroveň.



Make spaces appear higher.

Paint the cornice moulding
along with the ceiling.

it

Allarga visibilmente il tuo spazio.
Dipingi le cornici dello stesso colore del soffitto.

pl

Faça com que os espaços pareçam mais altos.
Pinte a sanca juntamente com o teto.

ro

Fa spațiile sa para mai mari.
Vopsește cornisa împreună cu tavanul.

cz

Udělejte svůj prostor vyšší.
Natřete stropní lištu barvou stropu.

LIVING ROOM

❶ C392 p.95

❷ PX116 p.111

❸ SX181 p.120

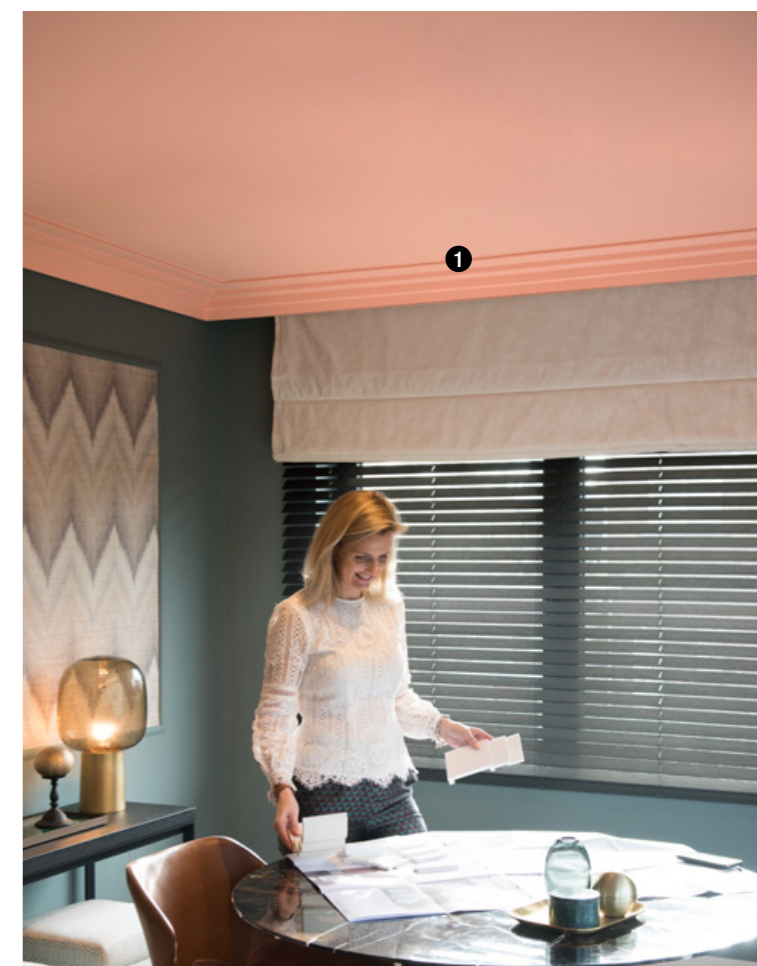



1 C354 p.86



1

LIVING ROOM



4:00pm *In the*
KITCHEN



PERSONALITY
IS THE BEST EXCUSE

Elegant transition.

Our cornice mouldings will tastefully hide any small imperfections between the wall and the ceiling.

1

2



KITCHEN

3 C990 + 2x P9900

it

Transizione elegante.
Le nostre cornici nascondono con discrezione le piccole imperfezioni tra parete e soffitto.

pt

Transição elegante.
As nossas sancas irão esconder cuidadosamente qualquer pequena imperfeição entre a parede e o teto.

ro

Tranzitie eleganta.
Cornisele noastre vor ascunde cu gust orice mici imperfectiuni dintre perete si tavan!

cz

Elegantní přeměna.
Vaše stropní lišta skvěle skryje malé nedokonalosti mezi stěnou a stropem.

1 C991 p.89

2 SX180 p.120

3 C990 + 2x P9900 p.92

4 SX181 p.120

KITCHEN



- ❶ C344 p.95
- ❷ P8030 p.106
- ❸ P4020 p.106
- ❹ SX118 p.120



❹ SX118

KITCHEN

- ❶ CB503 p.101
- ❷ DX157-2300 p.118
- ❸ DX162-2300 p.111
- ❹ PX120 p.111
- ❺ R66 p.146



it

Le linee e i disegni grafici rendono i tuoi interni più dinamici.

pl

Linhas e padrões gráficos acentuam o interior.

ro

Linii și modelele grafice accentuează interiorul.

cz

Grafické vzory a prvky pozvednou interiér.

Graphic lines and patterns

accentuate the interior.



KITCHEN



it

Esprimi la tua originalità.
Chi dice che la boiserie deve essere messa in basso?

pt

Seja original.
Quem disse que os painéis têm de ser aplicados até a cima?

ro

Fii original!
Cine spune ca panourile trebuie sa stea in partea de jos?

cz

Buďte originální.
Kdo řekl, že obložení stěn patří jen dolů?

KITCHEN

Be original.

Who says panelling has to go at the bottom?

❶ C217 p.88

❷ PX113 p.111

❸ SX137 p.119



Stately cornice mouldings

are the perfect finish
for your space.

it

Le cornici importanti rifiniscono perfettamente il tuo spazio.

pt

Sancas imponentes são o acabamento perfeito para o seu espaço.

ro

Profilele decorative sunt finisarea perfecta a spatiului tau.

cz

Okázalé stropní lišty jsou perfektním zakončením pro Váš interiér.

KITCHEN



1 C343 p.94



WEAR YOUR
PERSONALITY
WITH PRIDE



11:00am *In the*
BATHROOM

❶ DX174-2300 p.150

❷ PX175 p.111

❸ D340 p.150

❹ SX173 p.119



BATHROOM



Water-resistant. ——— Your bathroom deserves a beautiful finish too.



it

Resistenti all'acqua.
Anche il tuo bagno merita una raffinata decorazione.

pt

Resistente à água.
A sua casa de banho também merece um bonito acabamento.

ro

Rezistentă la apă.
Baia ta merita o finisare frumoasă!

cz

Voděodolné.
Vaše koupelna si zaslouží krásné zakončení také.

❶ C341 p.87

❷ SX155 p.119

❸ SX181 p.120

BATHROOM



Go multifunctional.

Give your
entire space
a consistent,
sleek look.

it

Osa il multifunzionale.
Crea uniformità e dona un look
puro al tuo spazio.

pt

Seja multifuncional.
Dê a todo o seu espaço um
visual consistente e elegante.

ro

Mergi pe multifuncional.
Oferă întregului spațiu un aspect
consistent și elegant.

cz

Použijte multifunkční prvky.
Dejte celému vašemu prostoru,
jednotný, elegantní vzhled.



1 DX159-2300 p.124

2 DX162-2300 p.98

3 C393 p.90

4 SX181 p.125

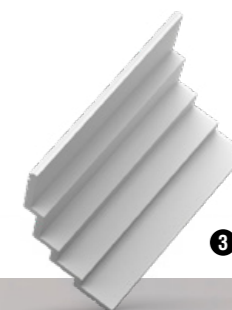

3 C393



BATHROOM



52

BATHROOM



- ❶ C341 p.87
- ❷ P8050 p.108
- ❸ SX118 p.120

53
BATHROOM

PERSONALITY

DESERVES A
PRIVATE SPACE



2:00pm *In the*
BEDROOM

BEDROOM



Good
night.

Turn your bedroom
into a true gem.



- ❶ CX127 p.100
- ❷ PX120 p.111
- ❸ PX103 p.110
- ❹ PX116 p.110
- ❺ SX137 p.119

il

Buona notte.
Trasforma la camera da letto in
un piccolo paradiso.

pt

Boa noite.
Transforme o seu quarto numa
verdadeira jóia.

ro

Noapte buna.
Transforma dormitorul într-o
adevarata bijuterie.

cz

Dobrou noc.
Přeměňte svou ložnici ve skutečný
poklad.

BEDROOM



- 1 C341 p.87
- 2 SX155 p.119



2 SX155

Light up the room.

Indirect lighting will take your space
to a new level.



it

illumina la stanza.
L'illuminazione indiretta porterà il tuo spazio ad un nuovo livello.

pt

ilumine o quarto.
A luz indireta elevará o seu espaço a uma nova dimensão.

ro

Lumineaza camera
Iluminarea indirecta va duce spatiul tau catre un nou nivel.

cz

Rozzářete prostor.
Nepřímé osvětlení pozvedne váš prostor do nové úrovně.

BEDROOM

❶ C990 + P9900 p.92

❷ C380 p.131

❸ C990 + 2xP9900 p.92



❸ C990 + 2x P9900



PROJECTS

Wake up in Palm Springs

— Casa Decor (es)



en

This interior takes you back to the iconic American architecture of the 1970s in Palm Springs. Interior specialist Patricia Bustos de la Torre gives this bedroom and bathroom the summer vibes of California with some soft pastels and curved shapes.

it

Questo ambiente ci riporta ai tempi dell'architettura americana degli anni '70 a Palm Springs. L'interior designer Patricia Bustos de la Torre ricrea l'atmosfera estiva nella camera da letto e nel bagno usando tonalità pastello e forme arrotondate.

pt

Este interior levo-o de volta á icónica arquitetura Americana de 1970 em Palm Springs. A especialista de Interiores Patricia Bustos de la Torre dá a este quarto e casa de banho as vibrações do Verão da Califórnia com cores pastel suaves e formas curvas.

ro

Acest interior te duce înapoi la arhitectura iconică americană din anii 1970 din Palm Springs. Specialistul de interior Patricia Bustos de la Torre dă acestui dormitor și acestei băi vibrațiile de vară din California, cu niște pasteluri soft și forme curbe.

cz

Tento interiér Vás vezme zpátky k ikonické americké architektuře 70-tých let v palm Springs. Interiérová specialistka Patricia Bustos de la Torre dodává ložnici a koupelně letní kalifornský nádech pastelovými barvami a zaoblenými tvary.



- 1 W102 p.143
- 2 W103 p.143
- 3 SX181 p.120
- 4 C392 p.95



Living Green

— Casa Decor (es)

en

Interior architects Inmaculada Recio and Silvia Trigueros presented their 'Living Green' suite at Casa Decor 2017 in Madrid. Their aim was to combine masculine and feminine styles in this stylish suite. They united the best of both worlds to create a classy, lively interior.

it

Durante Casa Decor 2017 a Madrid, gli architetti Inmaculada Recio e Silvia Trigueros hanno presentato la loro suite 'Living Green'. La realizzazione di questa suite aveva l'obiettivo di unire lo stile maschile e quello femminile. Combinando il meglio dei due mondi hanno creato un interno elegante e dinamico.

pt

As Arquitetas de Interiores Inmaculada Recio e Silvia Trigueros apresentaram a sua suite 'Living Green' na Casa Decor 2017 em Madrid. O seu objetivo foi combinar os estilos masculino e feminino nesta elegante suite. Uniram o melhor dos dois mundos para criar um interior elegante e animado.

ro

Arhitecții de interior Inmaculada Recio și Silvia Trigueros au prezentat suita lor» Living Green «la Casa Decor 2017 din Madrid. Scopul lor a fost să combine stilurile masculine și feminine în această suită elegantă. Ei au unit cei mai bun din ambele lumi pentru a crea un interior clasic, plin de viață.

cz

Interiéroví architekti Inmaculada Recio and Silvia Trigueros prezentovali jejich 'Living Green' suite na výstavě Casa Decor 2017 v Madridu. Jejich cílem byla kombinace páského a dámského světa v tomto stylovém suitu. Spojili to nejlepší z obou světů k vytvoření temperamentního interiéru na úrovni.

1 C393 p.90

2 CX160 p.98

3 C356 p.86

4 SX181 p.120



De Huiskamer

— Roeselare (be)



en

The inviting interior of this restaurant in Roeselare is bursting with personality. A multitude of roses on the ceiling add character to the property.

it

Questo simpatico ristorante a Roeselare esprime senza dubbio una forte personalità! Non uno, ma tanti rosoni decorano il soffitto e aggiungono originalità all'ambiente.

pt

O interior convidativo deste Restaurante em Roeselare está repleto de personalidade. Uma multidão de rosas no teto adiciona caráter à propriedade.

ro

Interiorul primitor al acestui restaurant din Roeselare explodeaza de personalitate. O multitudine de trandafiri pe tavan da caracter proprietății.

cz

Příjemný interiér této restaurace v Roeselare je velmi osobitý. Množství rozet umístěných na stropě dodává charakter celé nemovitosti.

- ❶ R10 p.145
- ❷ R31 p.145
- ❸ R17 p.145
- ❹ R52 p.146
- ❺ C340 p.90



Essentiel

— Antwerp (be)

- 1 C990 p.92
- 2 C322 p.86
- 3 SX155 p.119

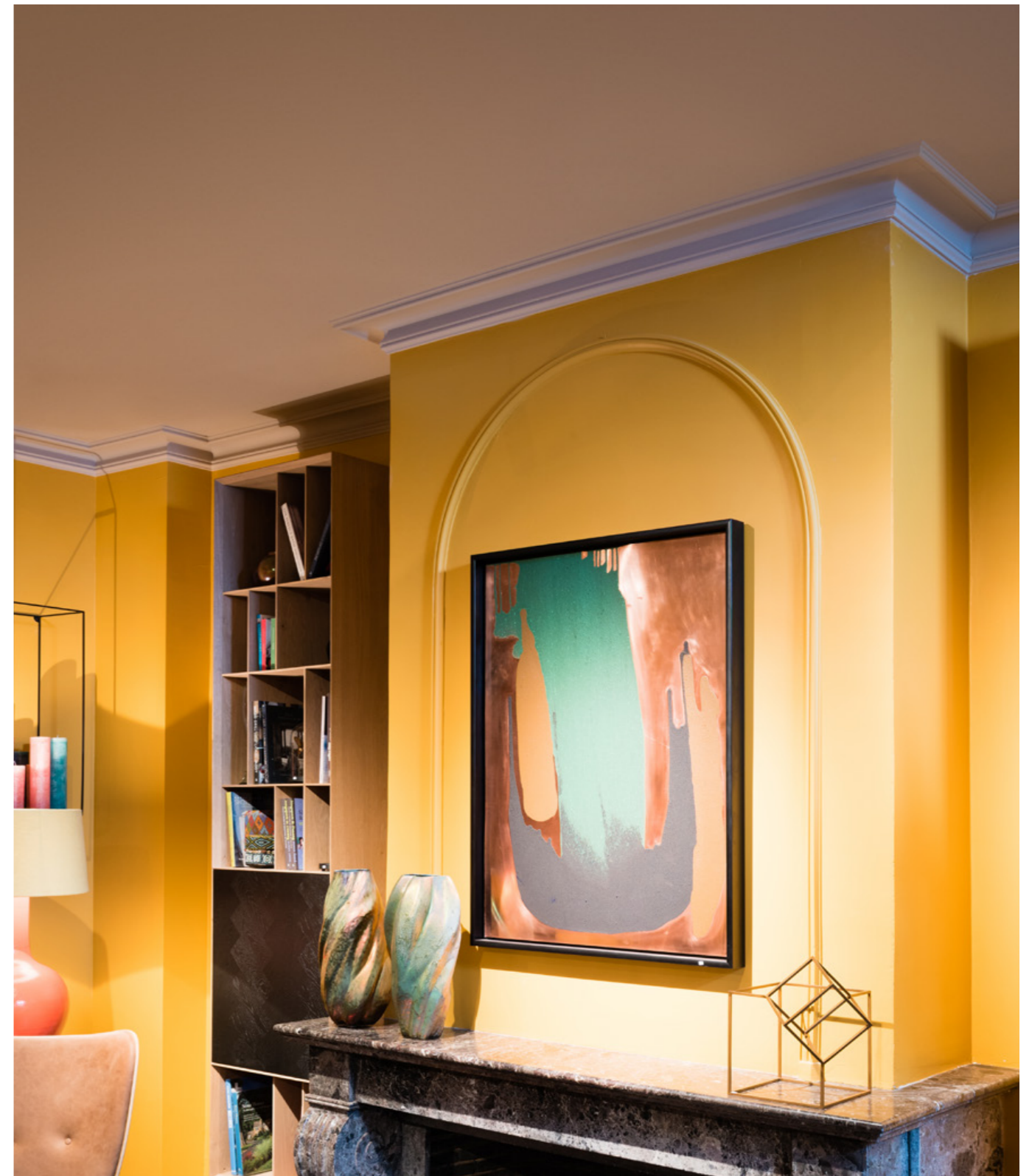
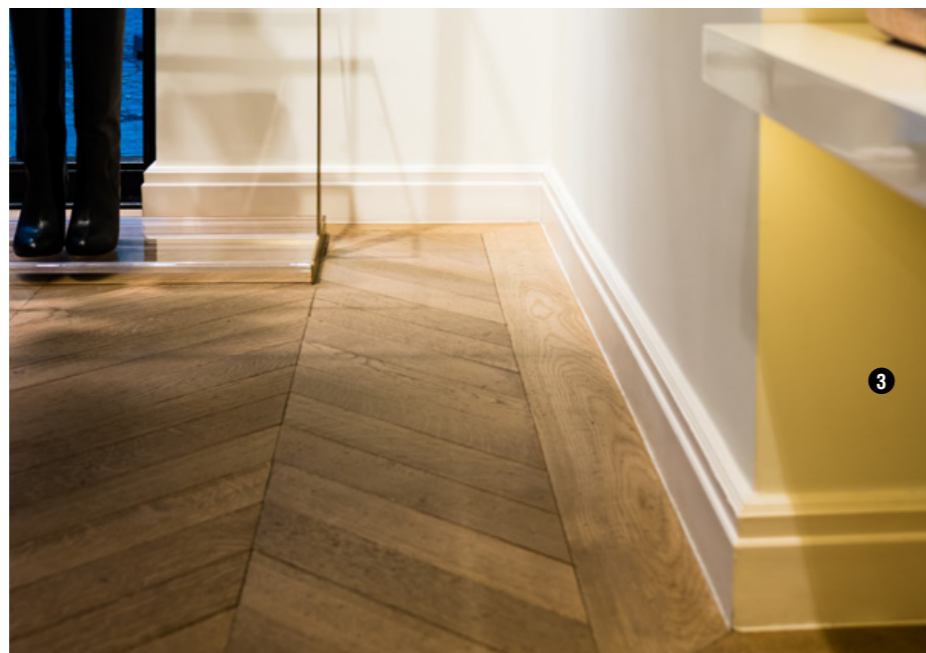
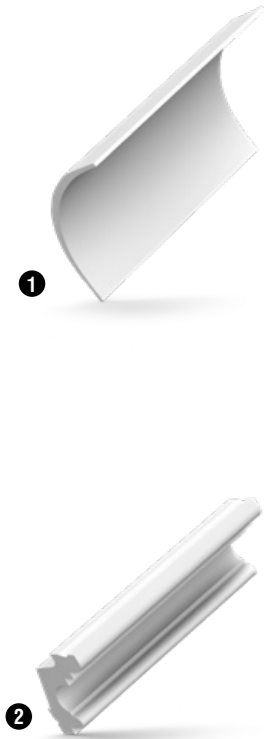

Frederiek Van Pamel

— Bruges (be)

Hotel Das Tegernsee

— Tegernsee (de)



- ❶ PX120 | PX120F p.111
- ❷ CX127 p.100
- ❸ P8020 p.106

en

The playful ceiling of the Hotel Tegernsee dining area leaves an instant impression. The creative use of our flexible mouldings shows how versatile it is.

it

L'aspetto giocoso del soffitto della sala da pranzo dell'hotel Tegernsee ha un effetto immediato e sorprendente. Le nostre cornici flessibili sono state applicate in modo originale dimostrando le innumerevoli possibilità di utilizzo.

pt

O teto divertido da sala de jantar do Hotel Tegernsee deixa uma impressão imediata. O uso criativo dos nossos perfis flexíveis mostra como é a versatilidade.

ro

Plafonul jucăuş al zonei de mese Hotel Tegernsee lasă o impresie instantanee. Folosirea creativă a profilelor noastre flexibile arată cât de versatile sunt acestea.

cz

Hravý strop hotelu Tegernsee zanechává okamžitý dojem. Kreativní použití ohebných profilů ukazuje, jak mnohostranné jsou.



The Mint

— Madrid (es)

en

The interior of this hotel certainly lives up to its name. The cool green hues throughout the hotel create a trendy, yet sophisticated ambience. The lines of the Orac Decor® mouldings complete the picture.

it

L'interno di questo hotel è sicuramente all'altezza del suo nome. Le fresche tonalità verdi in tutto l'hotel creano un ambiente alla moda e sofisticato. Il gioco di linee creato con le cornici Orac Decor® completano il quadro.

pt

O interior deste Hotel certamente faz jus ao seu nome. Os tons verdes frescos do Hotel criam um ambiente moderno e sofisticado. As linhas dos perfis Orac Decor® completam a imagem.

ro

Interiorul acestui hotel se ridică cu siguranță la numele său. Verdele dragut din hotel creează o ambianță modernă și totuși sofisticată. Linia profilelor Orac Décor® completează imaginea.

cz

Interiér tohoto hotelu jistě následuje jeho jméno. Chladné zelené odstíny v hotelu vytvářejí moderní, ale sofistikované prostředí. Linie Orac Décor® završují obraz.

❶ C200 p.87

❷ PX117 p.111





The Hoxton

— Paris (fr)

en

The ornate façade and cast-iron balconies of the hotel exude pure class. Inside the rooms, the panelling and cornice mouldings accentuate the sense of grandeur, as does the interplay between the various colours.

it

Il maestoso hotel, con i suoi balconi in ferro battuto e la sua facciata splendidamente decorata esprime un'eleganza rara. I lambris e le cornici, combinati con i colori, prolungano questa sensazione di grandezza anche nelle camere.

pt

A fachada ornamentada e as varandas em ferro fundido do Hotel transmitem pura classe. Dentro dos quartos, os perfis e as sancas acentuam a sensação de grandezza, assim como a interação entre as várias cores.

ro

Fațada ornamentată și balcoanele din fontă ale hotelului exudă clasa pură. În interiorul camerelor, muchiile de panouri și cornișe accentuează senzația de grandoare, la fel ca și interdependența dintre diferitele culori.

cz

Ozdobná fasáda a liatinové balkony hotelu vycházejí z čistého designu. Uvnitř pokojů zdobí obložení a stropní lišty vzbuzují pocit vznešenosti, stejně jako vzájemná souhra mezi různými barvami.

Ruin Revival

— London (uk)



- ❶ P7010 p.108
- ❷ P3020 p.106
- ❸ P8040 p.108
- ❹ P8030D p.113
- ❺ P3020A p.113



Materials

MATERIALI / MATERIAIS
MATERIALE / MATERIÁLY

PUROTOUCH[®]

A high-quality, high-density polyurethane that allows fine details.

Poliuretano di alta qualità e alta densità che consente dettagli ben definiti.

Um poliuretano de alta densidade e de alta qualidade que permite detalhes precisos.

Un poliuretan de înaltă calitate, de înaltă densitate, care permite detalii fine.

Vysoce kvalitní polyuretan vysoké hustoty umožňuje jemné detaily.

DUROPOLYMER[®]

An extruded and impact-resistant polymer based on a high-density polystyrene.

Polimero estruso resistente agli urti, formato da una miscela di polistirene ad alta densità.

Polímero extrudido, resistente a impactos, com base numa mistura de poliestireno de alta densidade.

Un polimer extrudat si rezistent la impact pe baza unui polistiren de inalta densitate..

Lisovaný, mechanicky odolný polymer na bázi hustého polystyrénu.

FLEX

A wide range of cornice mouldings, panel mouldings and skirting boards are also available in a flexible version.

Una vasta gamma di cornici soffitto, cornici parete e battiscopa sono disponibili anche in versione flessibile.

Uma ampla gama de sancas, perfis e rodapés estão disponíveis em versão flexível.

O gamă largă de cornișe, brauri și plinte sunt disponibile într-o versiune flexibilă.

Široká řada stropních, lemovacích, podlahových lišt je dostupná i v ohebné verzi.

DUROFOAM[®]

An extruded lightweight polymer based on a medium-density polystyrene blend.

Polimero leggero estruso, formato da una miscela di polistirene di media densità.

Polímero extrudido, leve, baseado numa mistura de poliestireno de média densidade.

Un polimer extrudat usor pe baza unui polistiren de medie densitate.

Lisovaný lehký polymer na bázi středně husté polystyrénové směsi.



	Detail Design	Impact Resistance
PUROTOUCH [®]	★ ★ ★	★ ★
DUROPOLYMER [®]	★ ★	★ ★ ★
DUROFOAM [®]	★	★

Product Overview

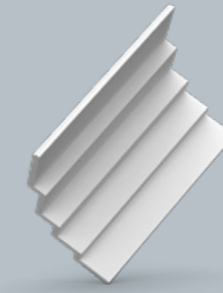

Cornice Mouldings

Cornici Soffitto / Sancias / Cornise / Stropní Lišty

Pg. 84

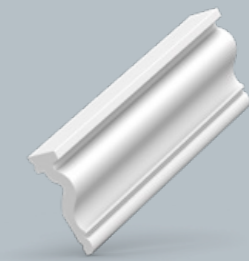

Panel Mouldings

Cornici Parete / Perfis Brauri / Lemovací Lišty

Pg. 104



Skirting

Battiscopa / Rodapés / Plinte / Podlahové Lišty

Pg. 114

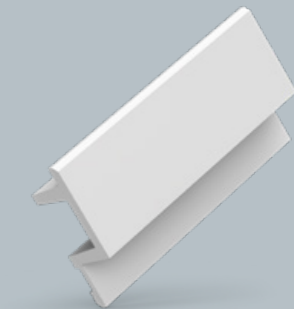

Indirect Lighting

Iluminazione Indiretta / Iluminação Indireta
Iluminatul indirect / Nepřímé Osvětlení

Pg. 126



Deco Elements

Elementi Decorativi / Elementos Decorativos
Elemente Decorative / Dekorativní Prvky

Pg. 138



The Perfect Finish

La Finitura Perfetta / O Acabamento Perfeito
Inisarea Perfecta / Perfektní Zakončení

Pg. 154

Cornice Mouldings

CORNICI SOFFITTO / SANCAS
CORNISE / STROPNÍ LIŠTY

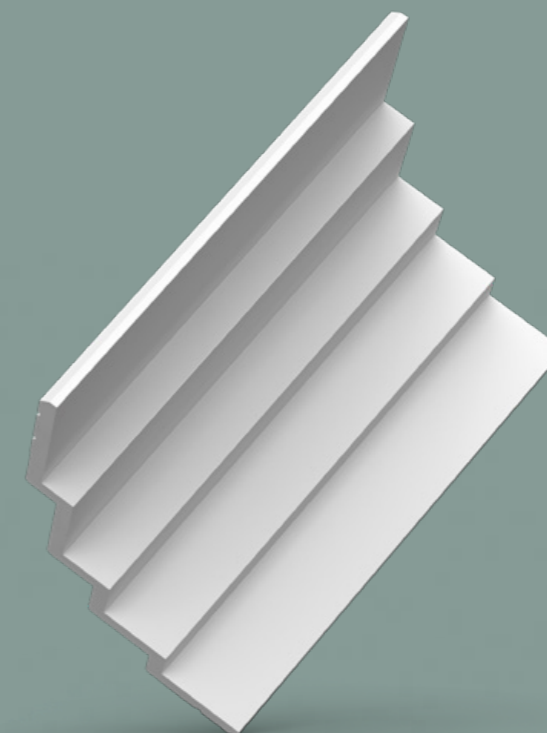

en

A cornice creates a visually attractive transition from wall to ceiling. From sleek to baroque, from decorative to functional – we offer a quality solution for every budget. The profiles are easy to install, and a large number of designs are available in flexible versions.

it

Una cornice aggiunge un effetto visivamente interessante nell'unione tra parete e soffitto. Qualunque sia il vostro budget, vi proponiamo una soluzione di qualità: dallo stile minimalista a quello barocco, dall'elemento decorativo a quello prettamente funzionale. Tutti i profili sono facili da installare e molti sono disponibili anche nella versione flessibile.

pt

Uma sanca cria um efeito visual interessante e atraente na transição entre a parede e o teto. Seja qual for o seu orçamento, oferecemos uma solução de qualidade. Do estilo minimalista ao barroco, do decorativo ao funcional. Perfis fáceis de instalar e muitos modelos estão disponíveis em versões flexíveis.

ro

O cornisa creeaza o tranzitie vizuala atractiva de la perete la tavan. De la elegant la baroque, de la decorativ la functional - oferim o solutie de calitate pentru fiecare buget. Profilele sunt usor de instalat, si o gama larga exista si in varianta flexibila.

cz

Stropní lišta vytváří vizuálně atraktivní přechod mezi stěnou a stropem. Od uhlazených po barokní, od dekorativních po funkční – nabízíme kvalitní řešení pro každý rozpočet. Profily se snadno instalují a značný počet designů je k dispozici i ve flexibilních verzích.

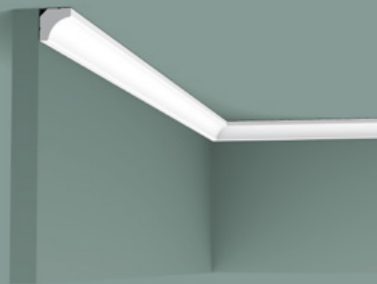

C250 | C250F
200 x 1,6 x 1,6 cm
Purotouch®

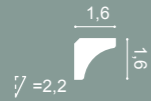

C360
200 x 2,1 x 6 cm
Purotouch®
Designed by
Jacques Vergracht



C356
200 x 2 x 10 cm
Purotouch®
Designed by
Jacques Vergracht



C391 STEPS
200 x 6 x 16 cm
Purotouch®
Designed by
Orio Tonini



C400
200 x 6 x 10 cm
Purotouch®

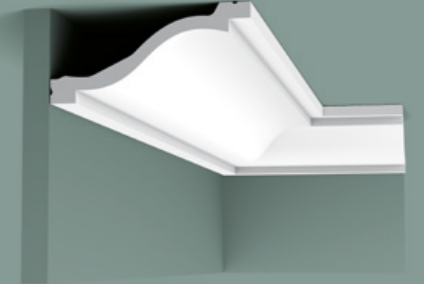

C331 | C331F
200 x 6,4 x 13,5 cm
Purotouch®

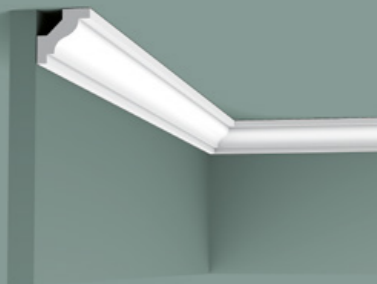

C230 | C230F
200 x 2,9 x 2,9 cm
Purotouch®

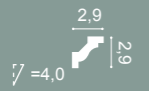

C353
200 x 3 x 16,5 cm
Purotouch®
Designed by
Jacques Vergracht



C355
200 x 3,5 x 11,1 cm
Purotouch®
Designed by
Jacques Vergracht



C200 | C200F
200 x 6,5 x 5,7 cm
Purotouch®



C214 | C214F
200 x 6,6 x 3,1 cm
Purotouch®

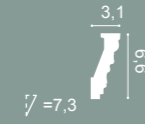

C212 | C212F
200 x 7,5 x 4,5 cm
Purotouch®



C354
200 x 4 x 21,5 cm
Purotouch®
Designed by
Jacques Vergracht

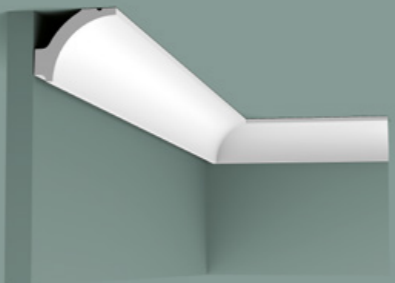
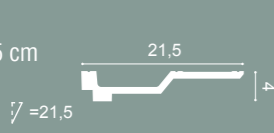

C260 | C260F
200 x 4,1 x 4,8 cm
Purotouch®

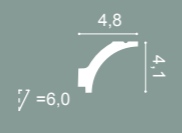

C215 | C215F
200 x 4,7 x 4,7 cm
Purotouch®

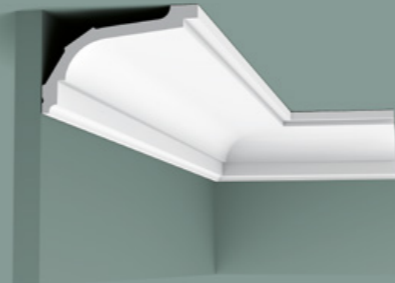

C220 | C220F
200 x 7,6 x 11,6 cm
Purotouch®

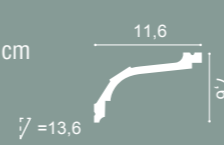

C213 | C213F
200 x 8 x 8 cm
Purotouch®

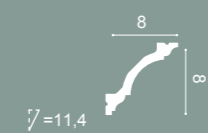

C240 | C240F
200 x 8 x 8 cm
Purotouch®



C322 | C322F
200 x 5 x 4,2 cm
Purotouch®



C602 | C602F
200 x 5,3 x 5 cm
Purotouch®



C390 STEPS
200 x 6 x 10 cm
Purotouch®
Designed by
Orio Tonini

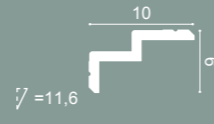

C341 | C341F HERITAGE M
200 x 8,8 x 12,2 cm
Purotouch®

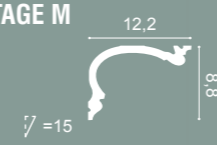

C321 | C321F
200 x 9,9 x 5 cm
Purotouch®

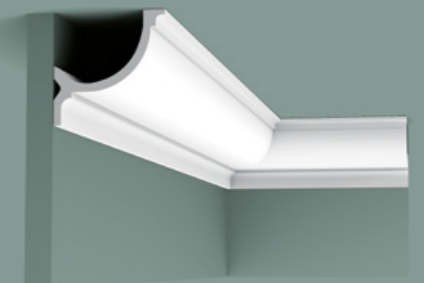
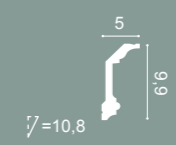

C902 | C902F
200 x 10,3 x 10,3 cm
Purotouch®

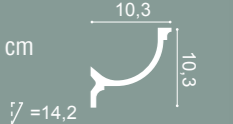



C217 | C217F
200 x 10,3 x 15,6 cm
Purotouch®
∠ = 18,3

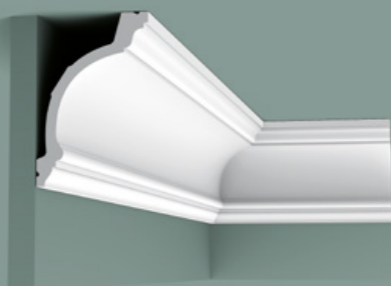

C217 | C217F
200 x 15,6 x 10,3 cm
Purotouch®
∠ = 18,3

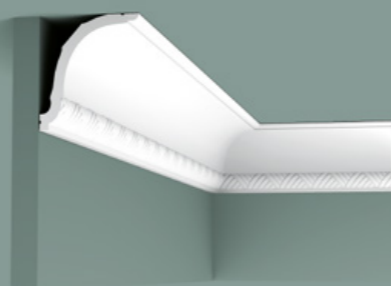

C402 | C402F
200 x 10,7 x 9,4 cm
Purotouch®
∠ = 13,9



C991
200 x 11 x 14 cm
Purotouch®
Designed by Ulf Moritz
∠ = 17,8



C991 + P9900
∠ = 23,3

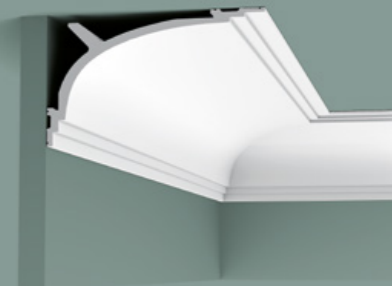

C991 + 2x P9900
∠ = 27,6

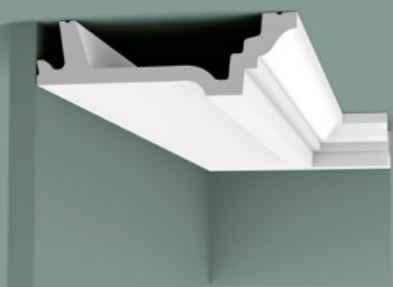

C305
200 x 4,7 x 15,5 cm
Purotouch®
∠ = 15,9

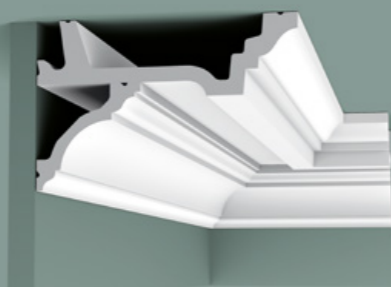

C305 + C213
∠ = 19,3



C305 + C211
∠ = 21,5



C991
200 x 14 x 11 cm
Purotouch®
Designed by Ulf Moritz
∠ = 17,8

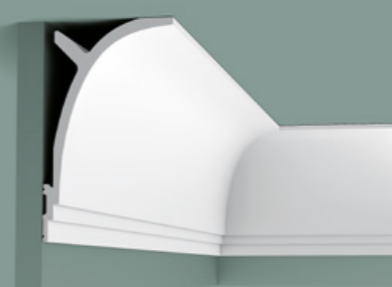

C991 + P9900
∠ = 22,6



C991 + 2x P9900
∠ = 27,6



❶ C990 + 2xP9900 p.92

❷ C381 p.131

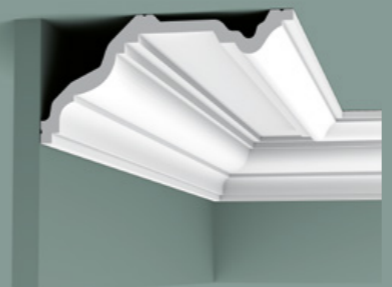

C332
200 x 11,4 x 23 cm
Purotouch®
∠ = 25



C332
200 x 23 x 11,4 cm
Purotouch®
∠ = 25



C201 | C201F
200 x 11,6 x 4,8 cm
Purotouch®
∠ = 12,5

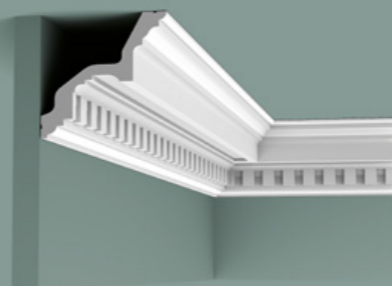

C211 | C211F
200 x 11,6 x 11,2 cm
Purotouch®
∠ = 15,8



C216 | C216F
200 x 11,6 x 13,3 cm
Purotouch®
∠ = 17,3



C304 | C304F
200 x 12,2 x 7,2 cm
Purotouch®
∠ = 13,9



C333 | C333F
200 x 12,2 x 11,1 cm
Purotouch[®]
∠ = 16,2



C302 | C302F
200 x 12,8 x 8,5 cm
Purotouch[®]
∠ = 15

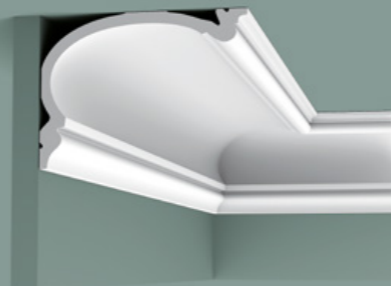

1 C342 HERITAGE L
200 x 14 x 19 cm
Purotouch[®]
∠ = 23,6



C340
200 x 25,6 x 13,5 cm
Purotouch[®]
∠ = 28,6



C340
200 x 13,5 x 25,6 cm
Purotouch[®]
∠ = 28,6



C339 | C339F
200 x 14,1 x 6,4 cm
Purotouch[®]
∠ = 15,2



C303 | C303F
200 x 14,4 x 6,5 cm
Purotouch[®]
∠ = 15,3

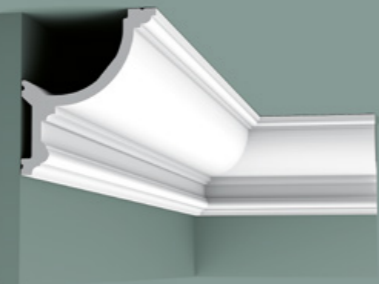

C901 | C901F
200 x 14,8 x 12,4 cm
Purotouch[®]
∠ = 19,2

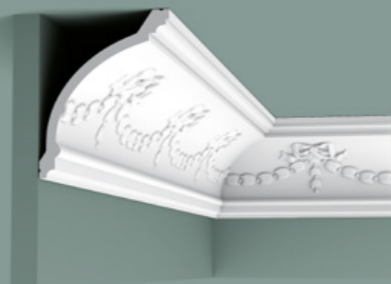

C218 | C218F
200 x 15 x 12 cm
Purotouch[®]
∠ = 19,1

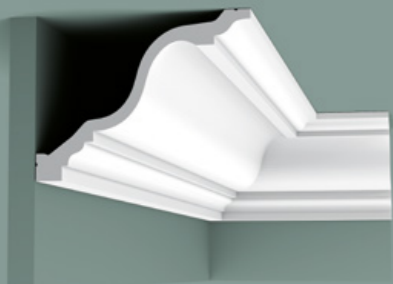

C334 | C334F
200 x 15 x 19,6 cm
Purotouch[®]
∠ = 24,1

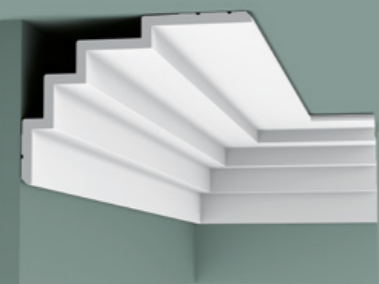

C393 STEPS
200 x 15 x 21 cm
Purotouch[®]
Designed by
Orio Tonini
∠ = 24,7

NEW





C990 INFINITY
200 x 15,9 x 21,6 cm
Purotouch®
Designed by
Xavier Donck

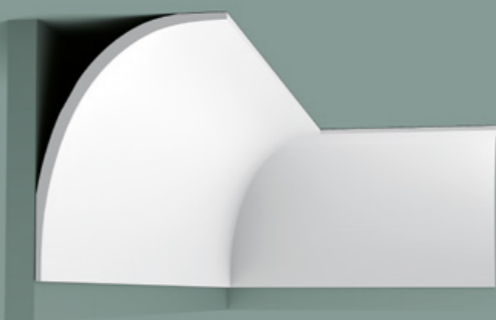

C990 INFINITY
200 x 21,6 x 15,9 cm
Purotouch®
Designed by
Xavier Donck

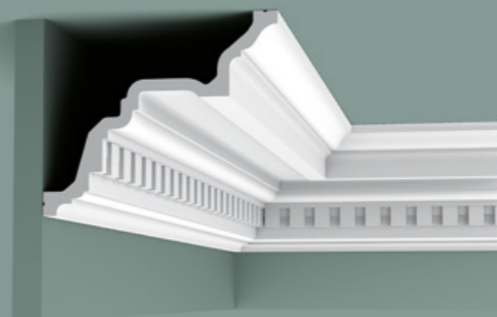
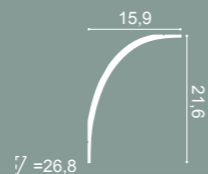

C422
200 x 16,4 x 19,4
Purotouch®

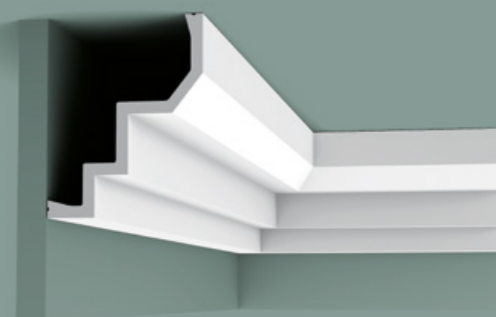
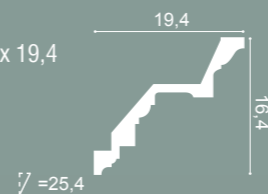

C300
200 x 16,5 x 13 cm
Purotouch®

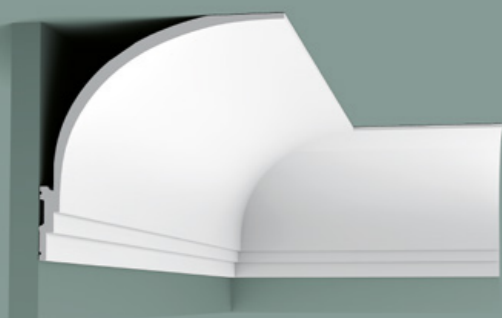
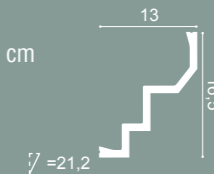

C990 + P9900

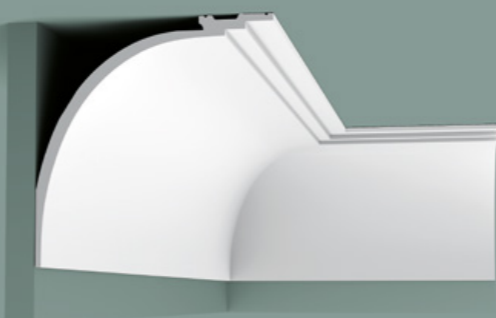
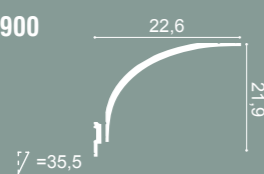

C990 + P9900

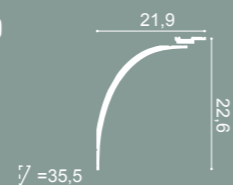

C301 | C301F
200 x 17 x 14,4 cm
Purotouch®

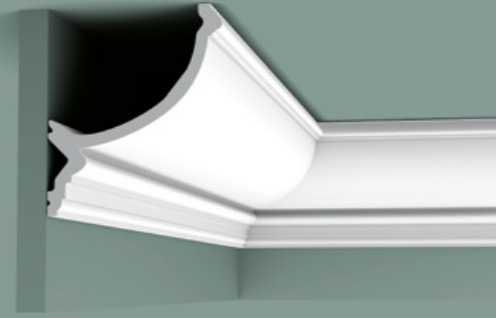
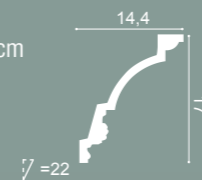

C900
200 x 17,1 x 14,6 cm
Purotouch®

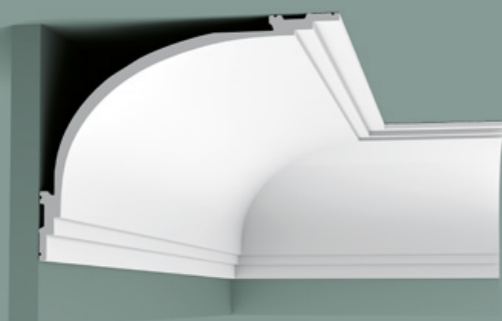
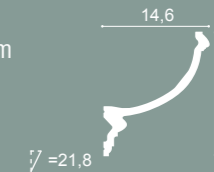

C990 + 2x P9900

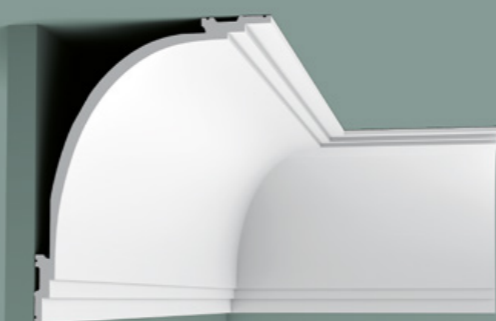
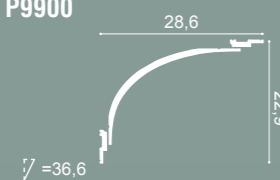

C990 + 2x P9900

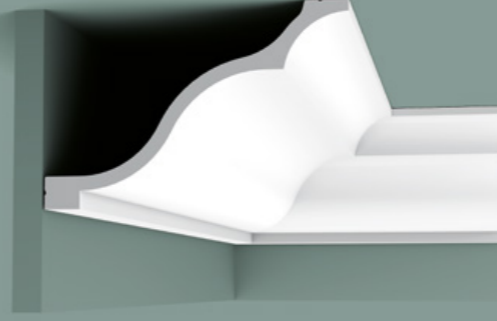
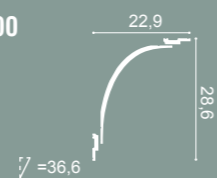

C337
200 x 17,2 x 25,6 cm
Purotouch®

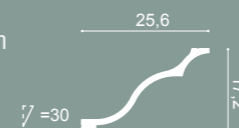

C219
200 x 17,6 x 13 cm
Purotouch®

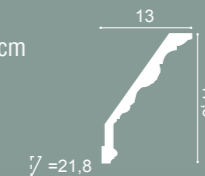

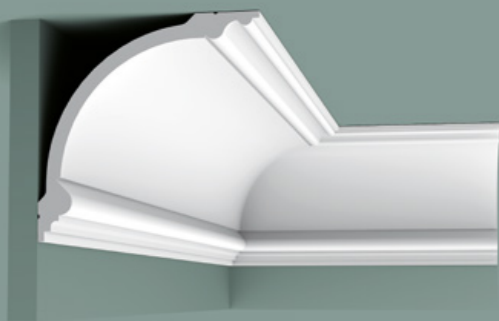

C338
200 x 18,4 x 18,4 cm
Purotouch®
18,4
18,4
∠ = 25,5



C338A BA'ROCK
200 x 18,4 x 18,4 cm
Purotouch®
18,4
18,4
∠ = 25,5

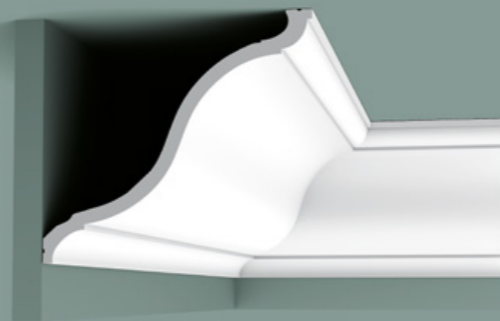

C335
200 x 20,2 x 22,2 cm
Purotouch®
Designed by
Xavier Donck
22,2
20,2
∠ = 29,3

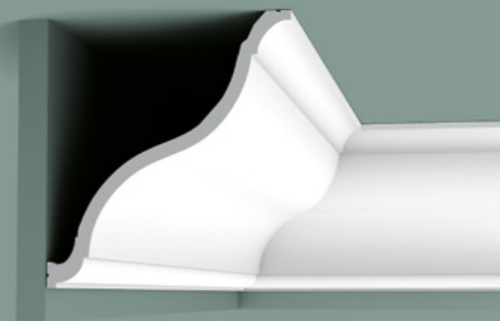

C335
200 x 22,2 x 20,2 cm
Purotouch®
Designed by
Xavier Donck
20,2
22,2
∠ = 29,3



C338B BA'ROCK
200 x 18,4 x 18,4 cm
Purotouch®
18,4
18,4
∠ = 25,5

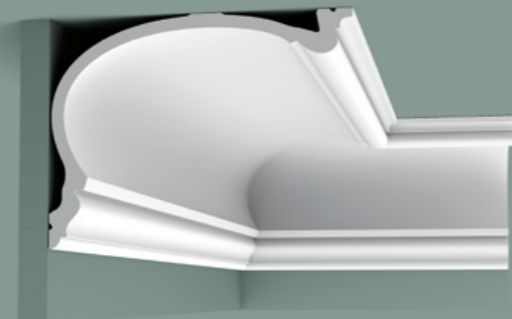

C343 HERITAGE XL
200 x 19 x 25 cm
Purotouch®
25
19
∠ = 31,4

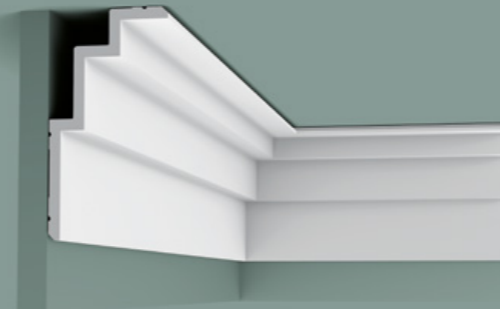

C392 STEPS
200 x 19 x 10 cm
Purotouch®
Designed by
Orio Tonini
10
19
∠ = 19,7



C308 | C308F
200 x 24,8 x 6,3 cm
Purotouch®
6,3
24,8
∠ = 25

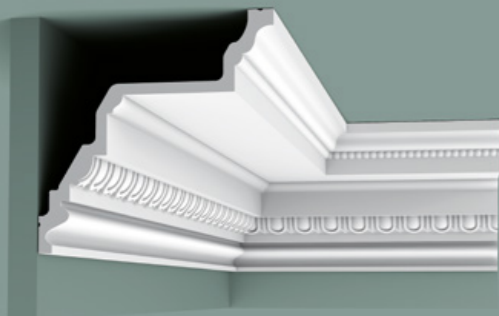

C307
200 x 19,5 x 19,5 cm
Purotouch®
19,5
19,5
∠ = 26,5

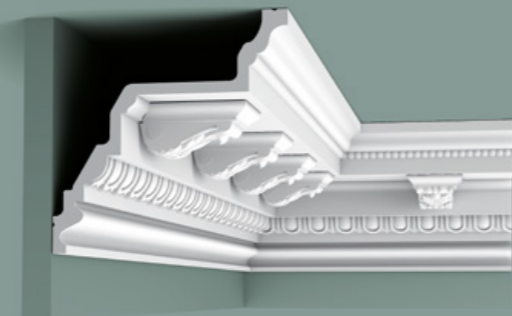

1 C307 + C307A 2
C307A: 7,5 x 4 x 9,4
Duropolymer®
19,5
9,4
4
5,61
∠ = 26,9



C336
200 x 27,1 x 26,6 cm
Purotouch®
26,6
27,1
∠ = 37,5

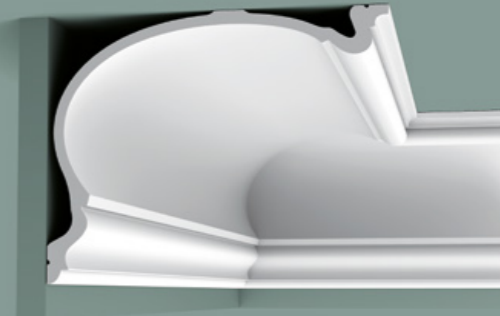

C344 HERITAGE XXL
200 x 27,3 x 35 cm
Purotouch®
35
27,3
∠ = 44,4

Steps



CORNICE MOULDINGS
CORNICI SOFFITTO
SANCAS
CORNISE
STROPNÍ LIŠTY

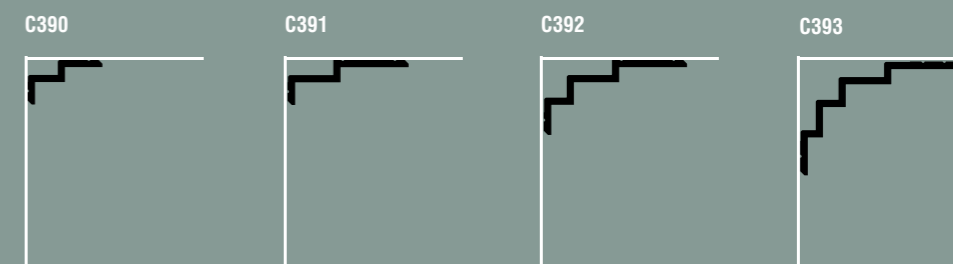

BORDER

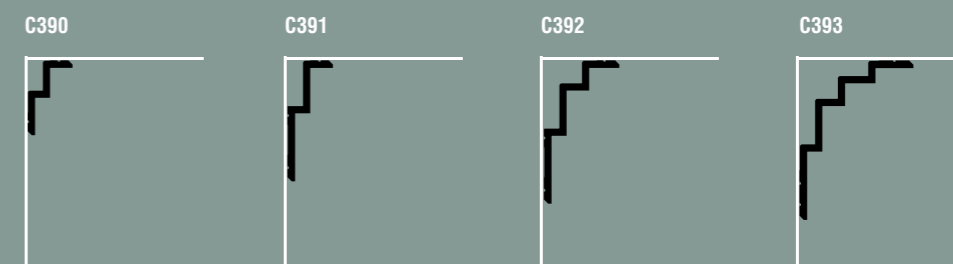

CURTAIN PROFILES
CORNICI PER TENDE
SANCAS PARA CORTINADOS
SINELE DE PERDEA
GARNÝŽOVÉ PROFILY

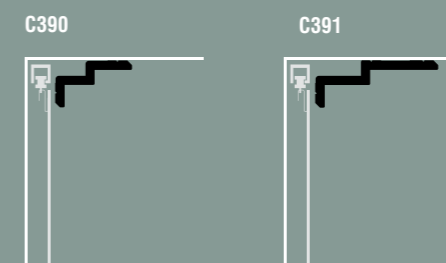

INDIRECT LIGHTING
ILLUMINAZIONE INDIRETTA
ILUMINAÇÃO INDIRETA
ILUMINATUL INDIRECT
NEPŘÍMÉ OSVĚTLENÍ

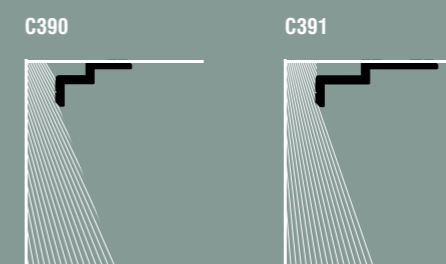



NEW FLEX

**DX162-2300 | DX162F
SQUARE**

230 x 1 x 4 cm (DX162-2300)
Duropolymer®
200 x 1 x 4 cm (DX162F)



NEW

**DX182-2300 | DX182F
CASCADE**

230 x 1,3 x 5 cm (DX182-2300)
Duropolymer®
200 x 1,3 x 5 cm (DX182F)



CX160

200 x 1,3 x 3,9 cm
Duropolymer®

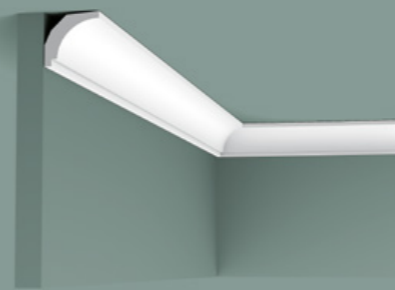

CX115

200 x 3 x 2,9 cm
Duropolymer®

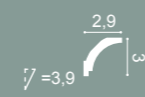

CX151

200 x 4 x 2,3 cm
Duropolymer®

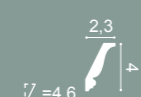

CX148 | CX148F

200 x 4,3 x 2,9 cm
Duropolymer®



**DX157-2300 | DX157F
SQUARE**

230 x 1,3 x 6,6 cm (DX157-2300)
Duropolymer®
200 x 1,3 x 6,6 cm (DX157F)



CX161

200 x 1,3 x 6,9 cm
Duropolymer®



NEW

**DX183-2300 | DX183F
CASCADE**

230 x 1,3 x 7,5 cm (DX183-2300)
Duropolymer®
200 x 1,3 x 7,5 cm (DX183F)

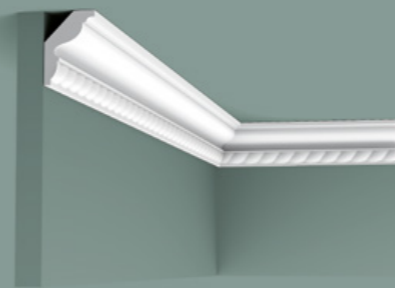

CX150

200 x 4,3 x 2,9 cm
Duropolymer®

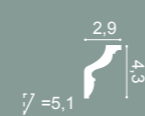

CX109 | CX109F

200 x 4,4 x 4,4 cm
Duropolymer®

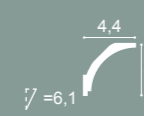

CX110 | CX110F

200 x 4,5 x 4,1 cm
Duropolymer®



NEW FLEX

**DX163-2300 | DX163F
SQUARE**

230 x 1,3 x 10,2 cm (DX163-2300)
Duropolymer®
200 x 1,3 x 10,2 cm (DX162F)



NEW

**DX184-2300 | DX184F
CASCADE**

230 x 1,3 x 11 cm (DX184-2300)
Duropolymer®
200 x 1,3 x 11 cm (DX184F)

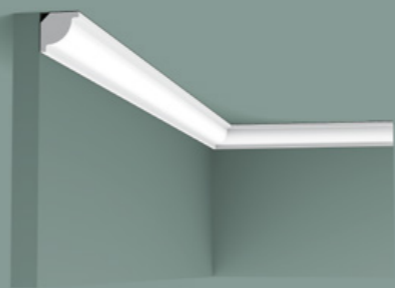

CX132 | CX132F

200 x 2 x 2 cm
Duropolymer®

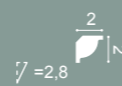

CX124 | CX124F

200 x 4,9 x 4,9 cm
Duropolymer®

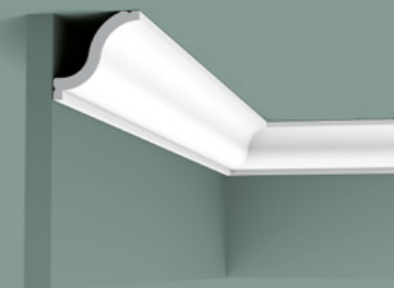
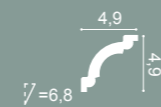

CX108

200 x 5,4 x 5,5 cm
Duropolymer®

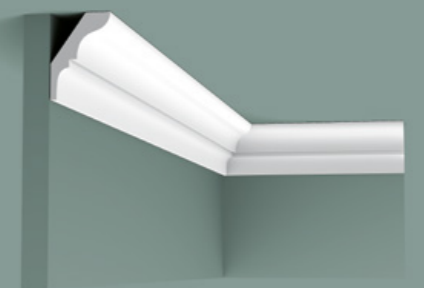
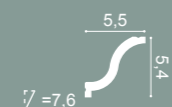

CX112

200 x 5,4 x 3,8 cm
Duropolymer®



CX133

200 x 2 x 2 cm
Duropolymer®

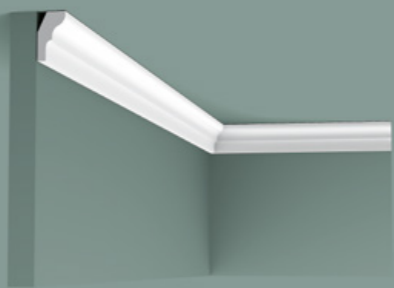
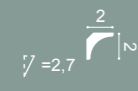

CX111

200 x 2,6 x 1,5 cm
Duropolymer®

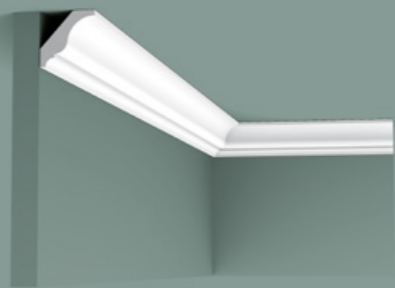
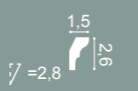

CX154

200 x 3 x 3 cm
Duropolymer®

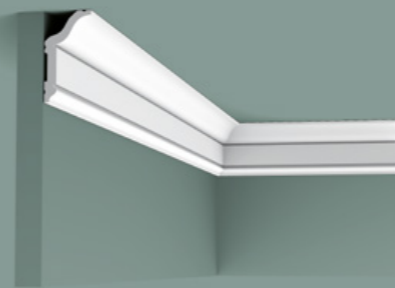
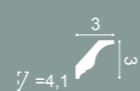

CX141

200 x 5,9 x 3,1 cm
Duropolymer®

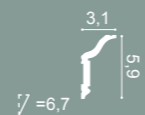

NEW

CX177

200 x 7 x 6 cm
Duropolymer®

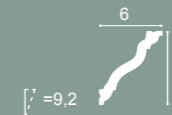

NEW

CX176

200 x 8 x 4 cm
Duropolymer®





CX100 | CX100F
200 x 6,9 x 7,1 cm
Duropolymer®

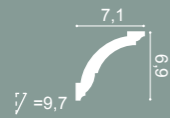

CX101
200 x 6,9 x 7,1 cm
Duropolymer®

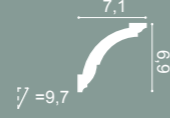

CX136
200 x 6,9 x 7,1 cm
Duropolymer®



CX123 | CX123F
200 x 8 x 8 cm
Duropolymer®

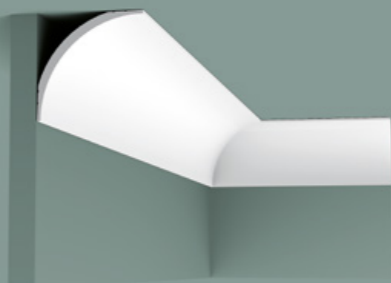

CX126
200 x 8,7 x 8,7 cm
Duropolymer®

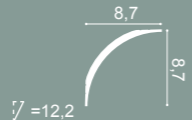

CX127 | CX127F
200 x 9,4 x 9,4 cm
Duropolymer®

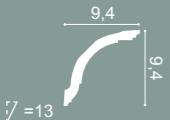

CX128
200 x 9,4 x 9,4 cm
Duropolymer®

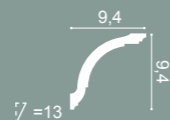

CX129
200 x 9,4 x 9,4 cm
Duropolymer®



CX106 | CX106F
200 x 11,8 x 11,7 cm
Duropolymer®

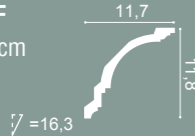

CX107
200 x 11,8 x 11,7 cm
Duropolymer®

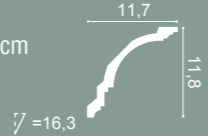

PX164
200 x 3 x 2,4 cm
Duropolymer®



PB513
200 x 1,5 x 3,4 cm
Durofoam®



CB500
200 x 2,5 x 1,8 cm
Durofoam®

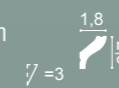

CB530
200 x 2,7 x 1,5 cm
Durofoam®

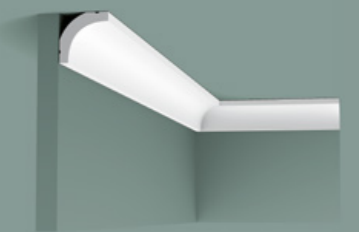
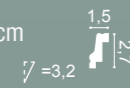

CB520
200 x 3,5 x 3,5 cm
Durofoam®



CB510
200 x 4 x 4 cm
Durofoam®



CB501
200 x 4,1 x 3,5 cm
Durofoam®



CB531
200 x 4,2 x 2,6 cm
Durofoam®

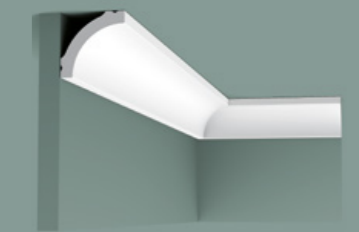

CB521
200 x 5 x 5 cm
Durofoam®

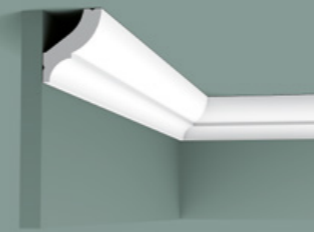

CB502
200 x 5,9 x 4,9 cm
Durofoam®



CB523
200 x 5,9 x 4,4 cm
Durofoam®



CB511
200 x 6,7 x 6,7 cm
Durofoam®

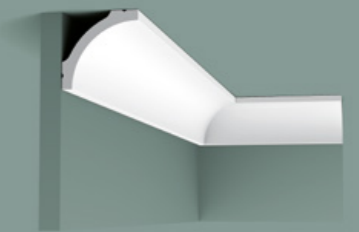
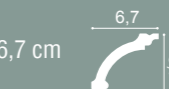

CB522
200 x 6,7 x 6,7 cm
Durofoam®



CB503
200 x 8,2 x 9,2 cm
Durofoam®

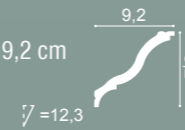

CB512
200 x 9,5 x 10 cm
Durofoam®

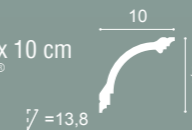

Curtain Profiles

CORNICI PER TENDE / SANCAS PARA CORTINADOS
SINELE DE PERDEA / GARNYŽOVÉ PROFILY



C341 | C341F HERITAGE M
CURTAIN PROFILE

200 x 8,8 x 12,2 cm
Purotouch[®]

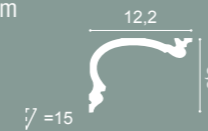

C342 HERITAGE L
CURTAIN PROFILE

200 x 14 x 19 cm
Purotouch[®]

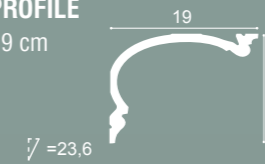

C343 HERITAGE XL
CURTAIN PROFILE

200 x 19 x 25 cm
Purotouch[®]

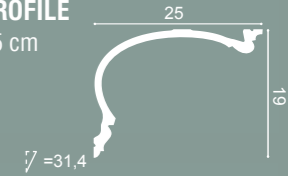

C390 STEPS
CURTAIN PROFILE

200 x 6 x 10 cm
Purotouch[®]

Designed by
Orio Tonini

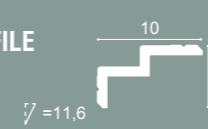

C391 STEPS
CURTAIN PROFILE

200 x 6 x 16 cm
Purotouch[®]

Designed by
Orio Tonini



C991
CURTAIN PROFILE

200 x 11 x 14 cm
Purotouch[®]

Designed by
Ulf Moritz

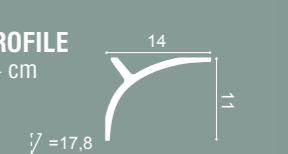

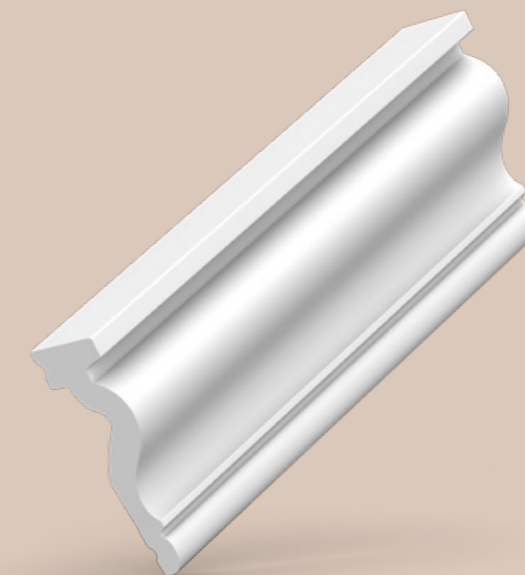

Panel Mouldings

CORNICI PARETE / PERFIS
BRAURI / LEMOVACÍ LIŠTY

en

Make flat walls come to life using "wallscaping" with our extensive panel mould range. Create attractive panelling or frames on walls and ceilings in a jiffy. All designs are easy to install, and many are available in a flexible format for use on curved walls and ceilings.

it

Portare nuova vita ad un semplice muro è ciò che chiamiamo "wallscaping". L'ampia gamma di cornici permette di creare in un batter d'occhio un lambris o un riquadro sulla parete o sul soffitto. Tutti i profili sono facili da posare e molti sono disponibili anche nella versione flessibile per pareti e soffitti curvi.

pt

Dar vida a uma parede lisa, chamamos a isso de "wallscaping". Utilizando a nossa extensa gama de perfis poderá criar painéis ou quadros atraentes em paredes e tetos num instante. Além de que são extremamente fáceis de instalar e muitos estão disponíveis em versão flexível para utilização em paredes e tetos.

ro

Pentru ca peretii banali sa revina la viata utilizam metoda «wallscaping» folosind gama noastra larga de produse. Creati panouri si ancadramente atractive pe pereti si tavane intr-o clipita. Toate decoratiunile sunt usor de instalat, si multe sunt disponibile in forma flexibila pentru a putea fi folosite pe pereti si tavane curbe.

cz

Oživte ploché stěny metodou „wallscaping“ pomocí naší početné řady lemovacích lišt. Umožní vám bleskově vytvářet na stěnách a stropěch atraktivní obklady nebo rámečky. Všechny designy se snadno instalují a mnohé jsou k dispozici ve flexibilní verzi, takže se dají použít na zakřivených stěnách a stropěch.

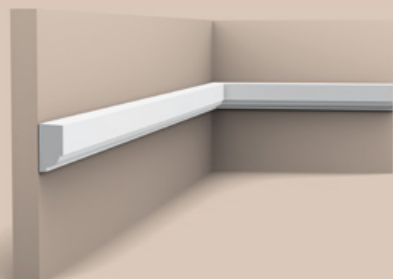

P9050 | P9050F
200 x 2,5 x 1,3 cm
Purotouch[®]

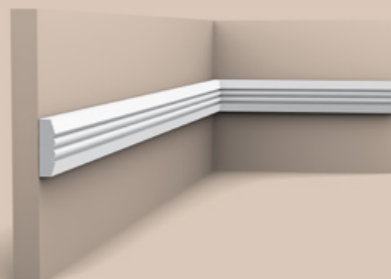

P5021 | P5021F
200 x 3,1 x 0,9 cm
Purotouch[®]

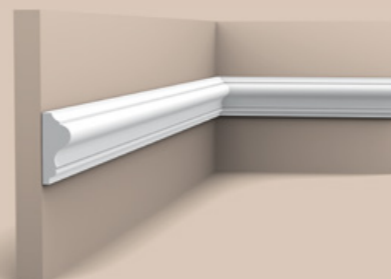

P8030 | P8030F
200 x 4,1 x 1,7 cm
Purotouch[®]

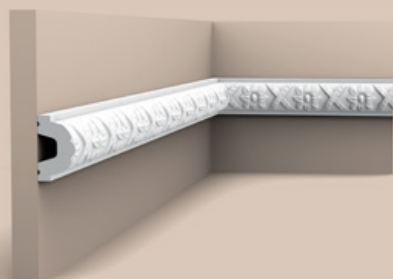

P2020 | P2020F
200 x 4,4 x 2,6 cm
Purotouch[®]

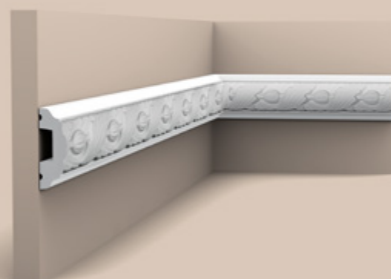

P1020 | P1020F
200 x 4,9 x 2,4 cm
Purotouch[®]

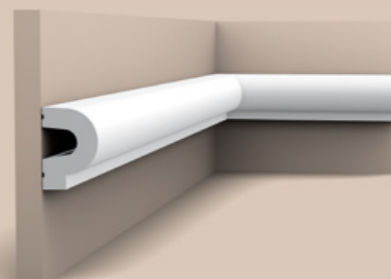

P8060 | P8060F
200 x 5 x 3,5 cm
Purotouch[®]



3 SX118 p.120

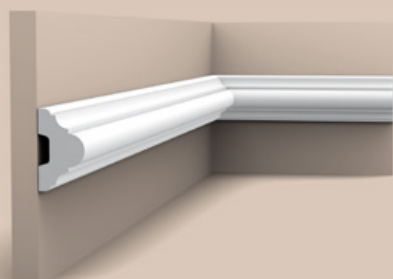

1 P4020 | P4020F
200 x 5 x 2,9 cm
Purotouch[®]

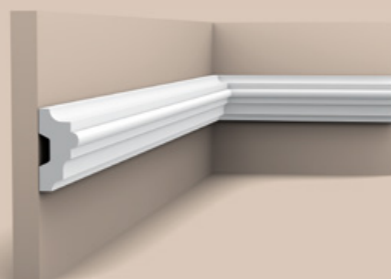

P9040 | P9040F
200 x 5 x 2,5 cm
Purotouch[®]

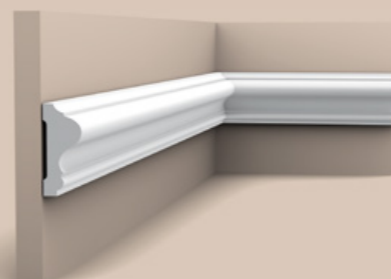

2 P8020 | P8020F
200 x 6 x 2,6 cm
Purotouch[®]

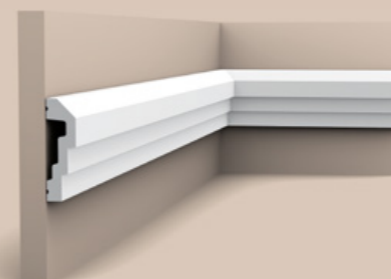

P7070 | P7070F
200 x 7,4 x 2,2 cm
Purotouch[®]

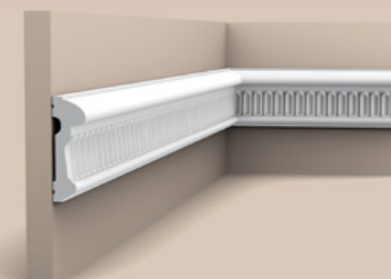

P7040 | P7040F
200 x 7,9 x 2,6 cm
Purotouch[®]

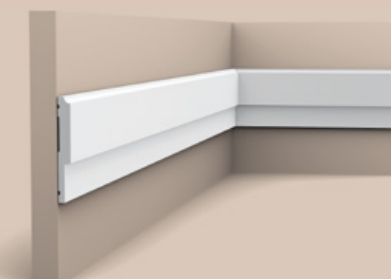

P9900 | P9900F
200 x 8 x 1 cm
Purotouch[®]

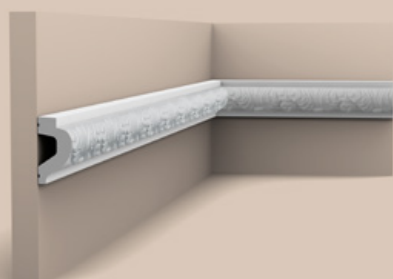

P3020 | P3020F
200 x 6,1 x 3,2 cm
Purotouch[®]

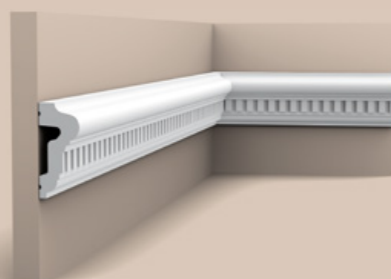

P6020 | P6020F
200 x 6,4 x 2,8 cm
Purotouch[®]

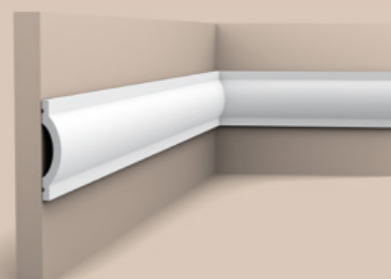

P9901 | P9901F
200 x 7 x 1,4 cm
Purotouch[®]

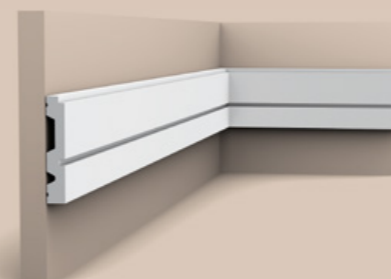

P5051
200 x 8,4 x 1,5 cm
Purotouch[®]
Designed by
Jacques Vergracht

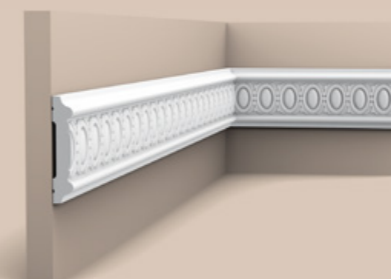

P7030 | P7030F
200 x 8,5 x 1,7 cm
Purotouch[®]

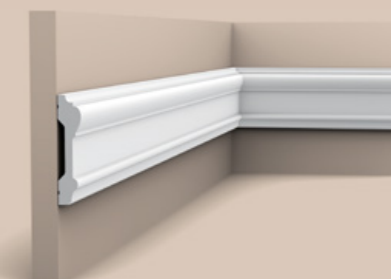

P9010 | P9010F
200 x 9,1 x 3 cm
Purotouch[®]



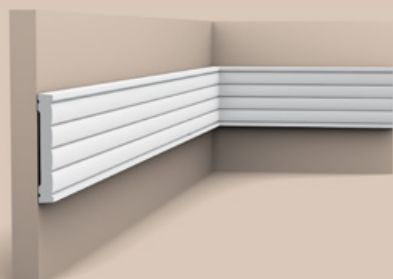

P5020 | P5020F
200 x 9,1 x 1,3 cm
Purotouch®

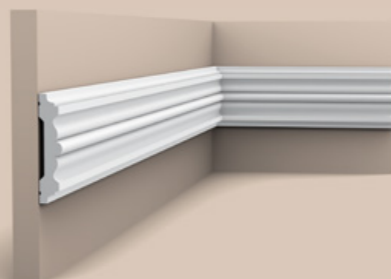

P9020 | P9020F
200 x 9,6 x 2,1 cm
Purotouch®

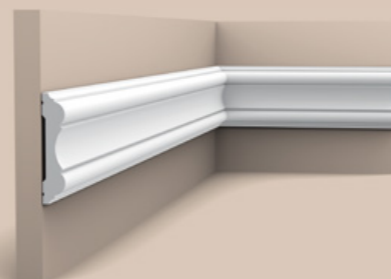

P8040 | P8040F
200 x 10,1 x 2,2 cm
Purotouch®

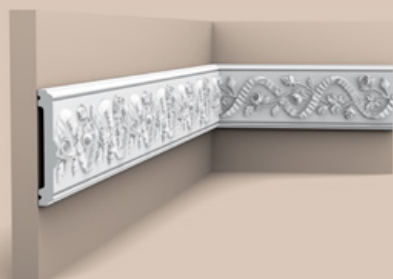

P7010 | P7010F
200 x 10,5 x 2 cm
Purotouch®

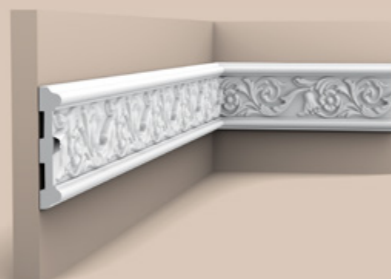

P7020 | P7020F
200 x 11,1 x 1,9 cm
Purotouch®

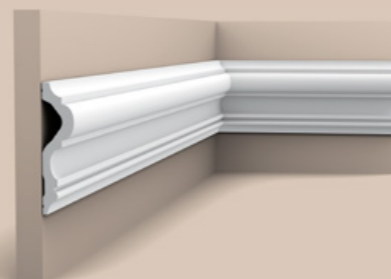

P8050 | P8050F
200 x 12 x 3 cm
Purotouch®

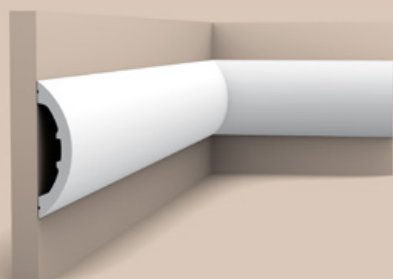

P3070 RADIUS
200 x 12,5 x 3,2 cm
Purotouch®
Designed by
Ulf Moritz

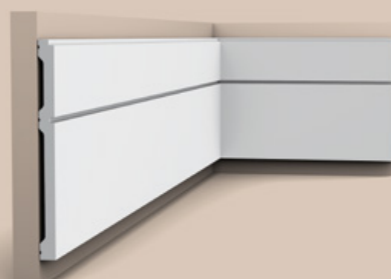

P5050
200 x 20 x 1,5 cm
Purotouch®
Designed by
Jacques Vergracht



P7080
200 x 21,8 x 2,9 cm
Purotouch®

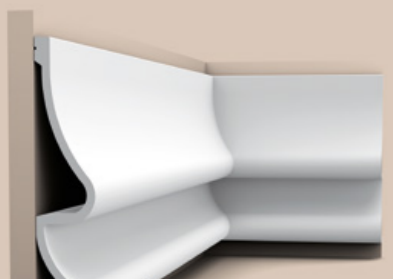

P3071 GOLF
200 x 37,2 x 7,6 cm
Purotouch®
Designed by
Ulf Moritz



- 1 DX170-2300 p. 150
- 2 P8020 p. 106
- 3 P4020 p. 106
- 4 D330LR p. 150
- 5 SX118 p. 120

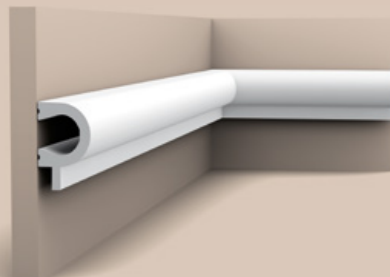

PX169 A
200 x 5,5 x 3,4 cm
Duropolymer[®]



PX147 B
200 x 16,9 x 0,9 cm
Duropolymer[®]

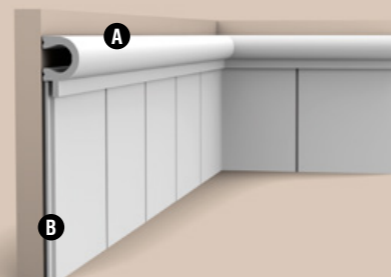
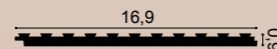

PX147 + PX169

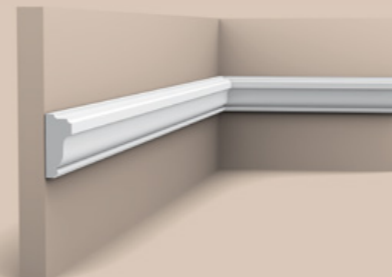

PX117
200 x 3,5 x 1,5 cm
Duropolymer[®]

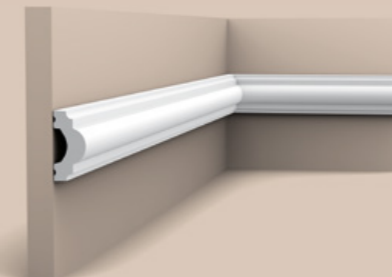

PX120 | PX120F
200 x 4 x 1,9 cm
Duropolymer[®]

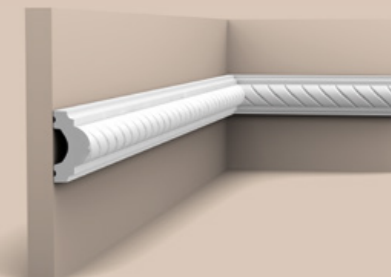

PX131
200 x 4 x 1,9 cm
Duropolymer[®]

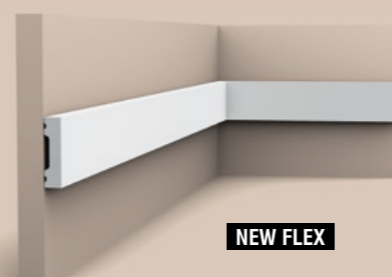

DX162-2300 | DX162F SQUARE
230 x 4 x 1 cm (DX162-2300)
Duropolymer[®]
200 x 4 x 1 cm (DX162F)

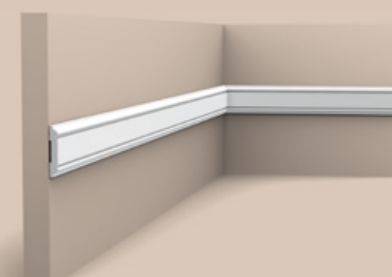

PX144 | PX144F
200 x 4,7 x 0,8 cm
Duropolymer[®]

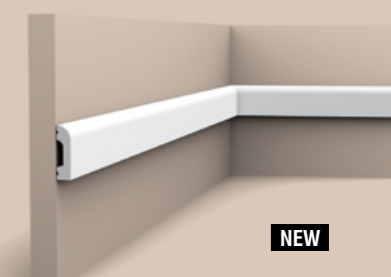

DX182-2300 | D182F CASCADE
230 x 5 x 1,3 cm (DX182-2300)
Duropolymer[®]
200 x 5 x 1,3 cm (DX182F)

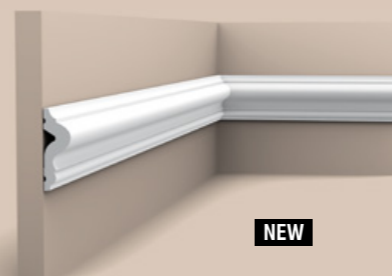

PX175 | PX175F
200 x 5 x 1,7 cm
Duropolymer[®]

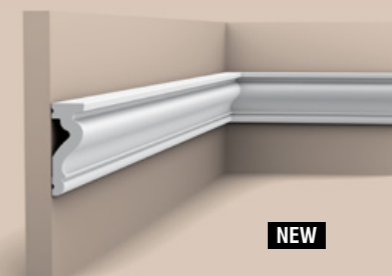

DX174-2300 | DX174F
230 x 6 x 2,2 cm (DX174-2300)
Duropolymer[®]
200 x 6 x 2,2 cm (DX174F)

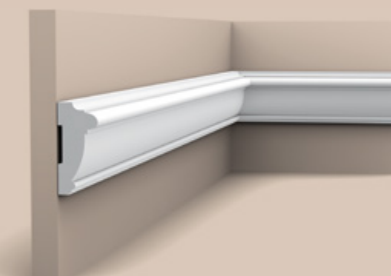

PX113
200 x 6 x 2,7 cm
Duropolymer[®]

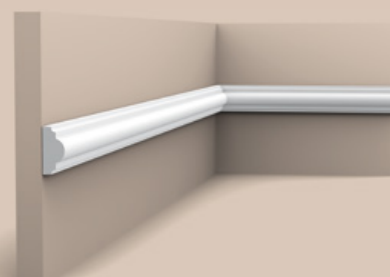

PX103 | PX103F
200 x 2,5 x 1,2 cm
Duropolymer[®]

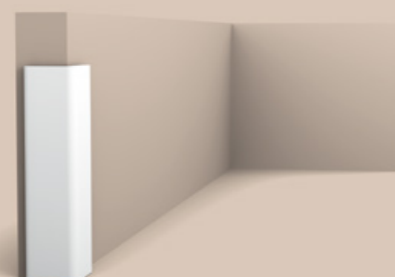

CX134
200 x 3 x 3 cm
Duropolymer[®]

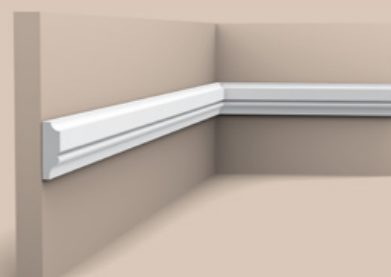

PX116
200 x 3,1 x 1 cm
Duropolymer[®]

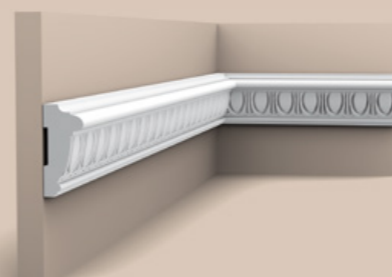

PX114
200 x 6 x 2,7 cm
Duropolymer[®]

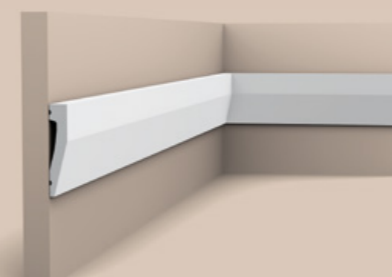

DX159-2300
230 x 6 x 1,2 cm
Duropolymer[®]

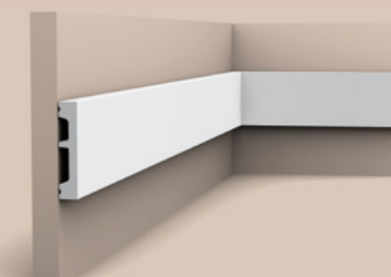

DX157-2300 | DX157F SQUARE
230 x 6,6 x 1,3 cm (DX157-2300)
Duropolymer[®]
200 x 6,6 x 1,3 cm (DX157F)



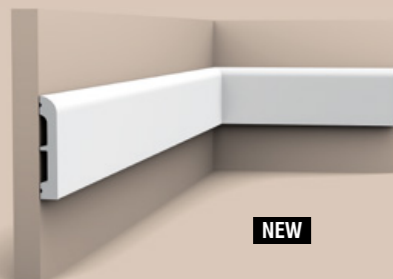

NEW

**DX183-2300 | DX183F
CASCADE**
230 x 7,5 x 1,3 cm (DX183-2300)
Duopolymer®
200 x 7,5 x 1,3 cm (DX183F)

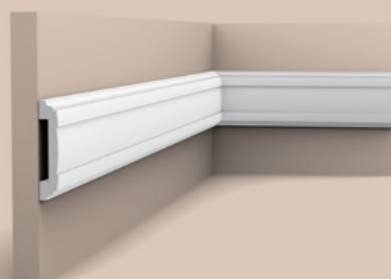

PX102
200 x 7,9 x 1,6 cm
Duopolymer®

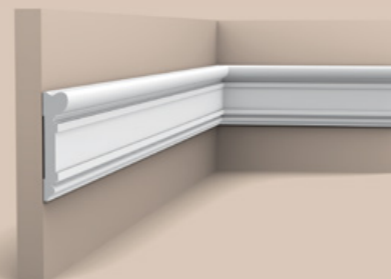

DX119-2300
230 x 9,2 x 2,2 cm
Duopolymer®

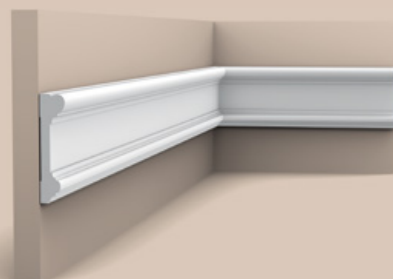

DX121-2300
230 x 9,4 x 2,3 cm
Duopolymer®

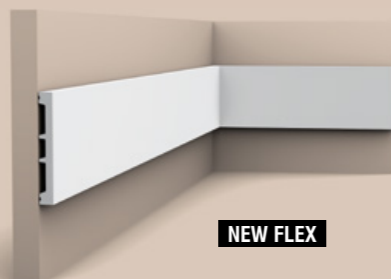

NEW FLEX

**DX163-2300 | DX163F
SQUARE**
230 x 10,2 x 1,3 cm (DX163-2300)
Duopolymer®
200 x 10,2 x 1,3 cm (DX163F)

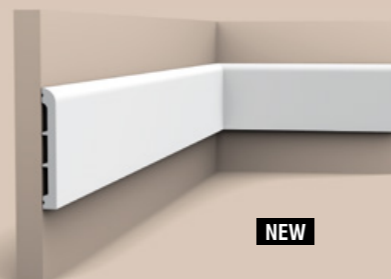

NEW

**DX184-2300
CASCADE**
230 x 11 x 1,3 cm (DX184-2300)
Duopolymer®
200 x 11 x 1,3 cm (DX184F)

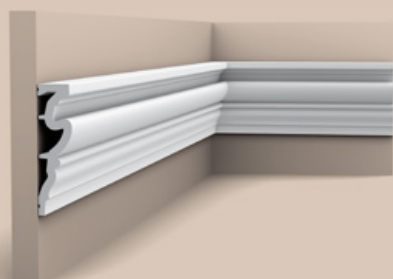

DX170-2300
230 x 11,9 x 3,2 cm
Duopolymer®

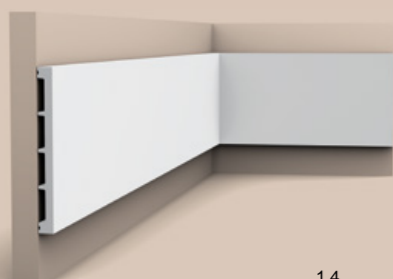

**DX168-2300
SQUARE**
230 x 15,1 x 1,4 cm
Duopolymer®

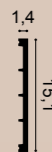

- 1 P3020 p.106
- 2 P8020 p.106
- 3 P3020A

- 4 P8050 p.108
- 5 SX118 p.120
- 6 P8040 p.108



P5020B + P5020
9 x 9 x 1,3 cm
Purotouch®



P101A + P1020
24,5 x 24,5 x 2,4 cm
Purotouch®



P201A + P2020 + P21
19,5 x 19,5 x 2,6 cm
Purotouch®



P801C + P8020
19,8 x 11 x 2,6 cm
Purotouch®



P4020A + P4020
16,4 x 9,1 x 2,9 cm
Purotouch®



3 P3020A + P3020
42,5 x 42,5 x 4 cm
Purotouch®

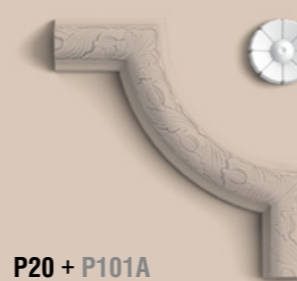

P20 + P101A
Ø 6,1 - 0,8 cm
Duopolymer®



P21 + P201A
6,7 x 6,7 x 0,9 cm
Duopolymer®



PX103A + PX103
19 x 3,5 x 1,2 cm
Duopolymer®



P8030D + P8030
13,2 x 13,2 x 1,7 cm
Duopolymer®



P8030C + P8030
19 x 8,6 x 1,7 cm
Duopolymer®

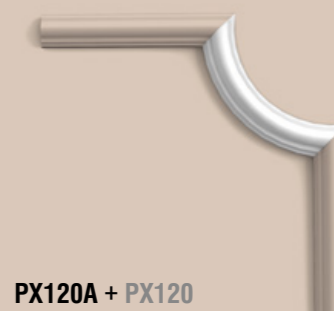

PX120A + PX120
19 x 8,8 x 2 cm
Duopolymer®

Skirting

BATTISCOPA / RODAPÉS
PLINTE / PODLAHOVÉ LIŠTY

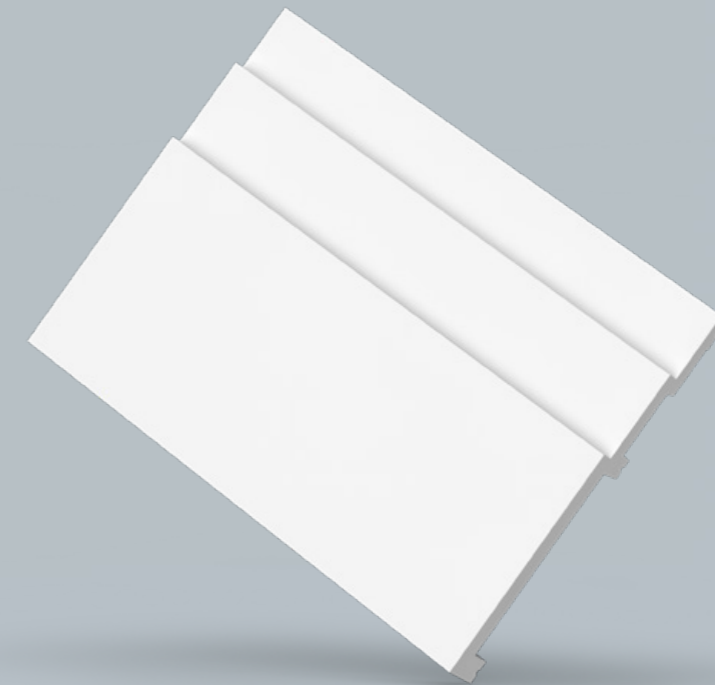

en

All skirting boards are made from Duropolymer®, an impact- and water-resistant polymer mix that is fully recyclable. Cables can be hidden easily, and the flexible versions allow curved walls to be finished elegantly. The skirting boards are pre-primed for easy painting.

it

Tutti i battiscopa sono realizzati in Duropolymer®, una miscela di polimeri resistente agli urti e all'acqua completamente riciclabile. I cavi possono essere facilmente nascosti e, nella versione flessibile, sono la soluzione ideale per pareti curve. I battiscopa sono trattati con un primer per poter essere facilmente verniciati.

pt

Todos os rodapés são produzidos com Duropolymer®, uma mistura de polímeros de alta densidade, resistentes à água e a impactos, totalmente reciclável. Os cabos podem ser facilmente ocultados e as versões flexíveis permitem, para paredes curvas, um acabamento elegante e distinto. Os rodapés vêm com uma camada de primário, para uma pintura fácil.

ro

Toate plintele sunt realizate din Duropolymer®, un amestec de polimer rezistent la impact si apa, care este 100% reciclabil. Acestea permit ascunderea cablurilor cu usurinta, iar varianta flexibila permite finisarea eleganta a peretilor curbi. Plintele vin deja cu un strat de grund si pot fi usor vopsite.

cz

Všechny podlahové lišty jsou vyrobeny z materiálu Duropolymer®, což je mechanicky a voděodolná polymerová směs. Tento materiál je plně recyklovatelný. Umožňují snadno skrýt kabely a pomocí flexibilních verzí je možné elegantně zakončit zakřivené stěny. Podlahové lišty jsou natřeny základním nátěrem, takže je lze snadno přetřít.

3 SKIRTING FAMILIES

CHOOSE YOUR STYLE. GET CREATIVE.

it

3 famiglie di battiscopa.
Scegli il tuo stile. Esprimi la tua creatività.

pl

3 familias de rodapés.
Escolha o seu estilo. Seja criativo.

ro

3 familii de plinte.
Alegeți stilul.

cz

3 rodiny podlahových lišt.
Vyberte si svůj styl. Buďte kreativní.

SQUARE



CASCADE



CONTOUR



SMALL

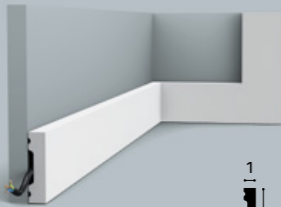

DX162-2300 | DX162F

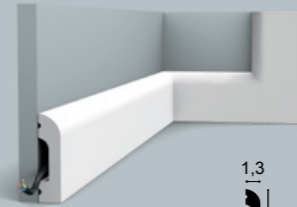

DX182-2300 | DX182F

NEW

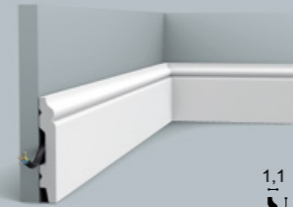

SX165 | SX165F



MEDIUM

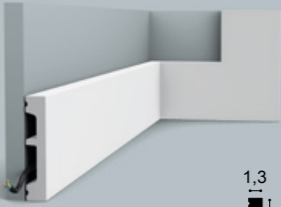

DX157-2300 | DX157F

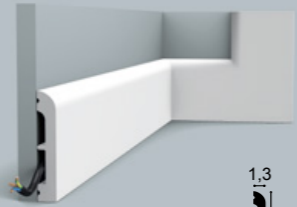

DX183-2300 | DX183F

NEW



SX173 | SX173F

NEW



BIG

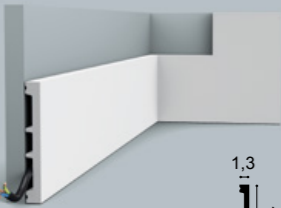

DX163-2300 | DX163F

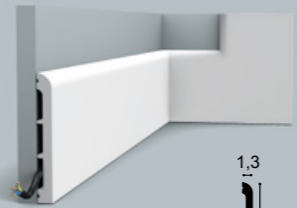

DX184-2300 | DX184F

NEW

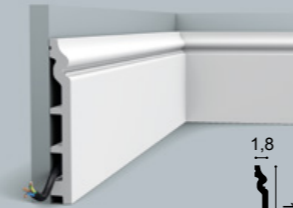

SX118 | SX118F



COVER

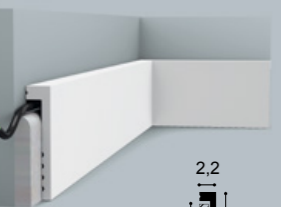

SX171

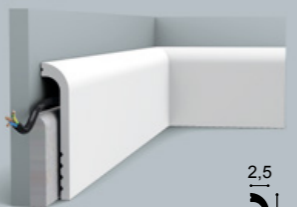
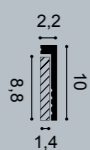

SX185

NEW

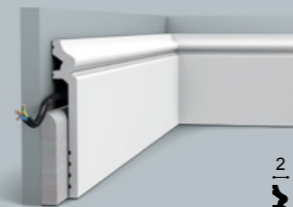
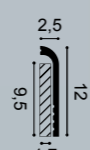

SX186

NEW



ADVANTAGES

VANTAGGI / VANTAGENS / AVANTAJE / VÝHODY

PAINTABLE



Verniciabile | Pintável
Vopsibil | Přetratelné

WATER RESISTANT



Resistente all'acqua | Resistente à água
Rezistent la apă
Voděodolné

SHOCK RESISTANT



Resistente agli urti | Resistente a impactos
Rezistent la șoc | Odolné nárazu

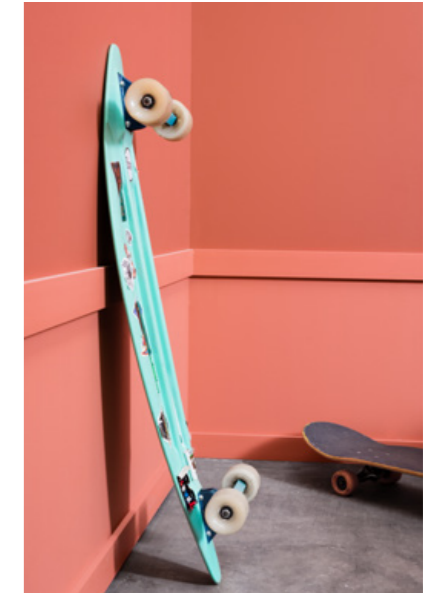

FLEXIBLE



Flessibile | Flexível
Flexibil | Ohebné

MULTIFUNCTIONAL



Multifunzionale | Multifuncional
Multifuncional | Multifunkční

COVER SKIRTING



Copri battiscopa | Rodapés de Sobreposição
Plinta de acoperire
Krycí podlahová lišta



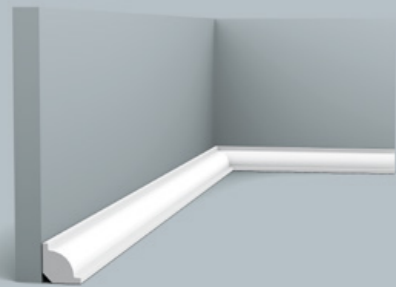

CX132 | CX132F
200 x 2 x 2 cm
Duopolymer®

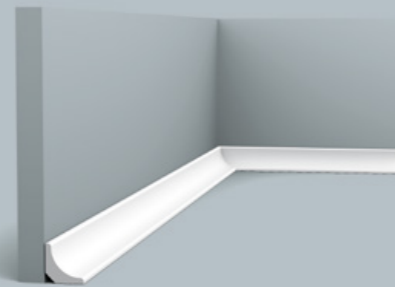

CX133
200 x 2 x 2 cm
Duopolymer®

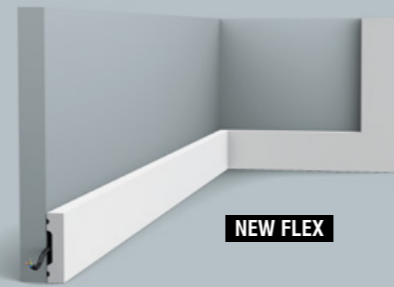

NEW FLEX
DX162-2300 | DX162F
SQUARE
230 x 4 x 1 cm (DX162-2300)
Duopolymer®
200 x 4 x 1 cm (DX162F)

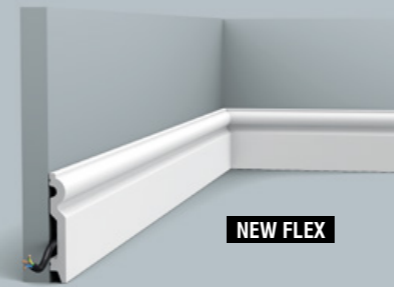

NEW FLEX
SX137 | SX137F
200 x 9,9 x 1,5 cm
Duopolymer®

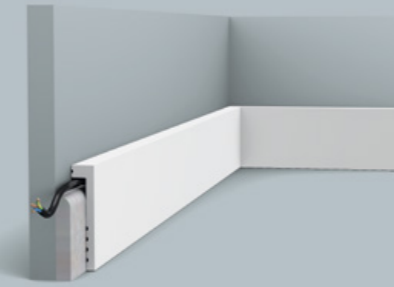

SX171
SQUARE
200 x 10 x 2,2 cm
Duopolymer®

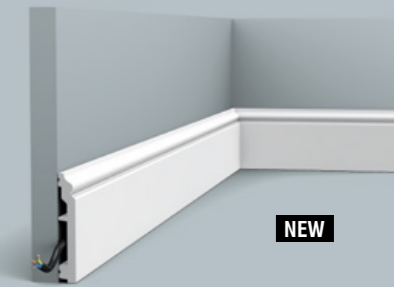
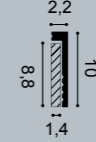

NEW
SX173 | SX173F
CONTOUR
200 x 10 x 1,6 cm
Duopolymer®

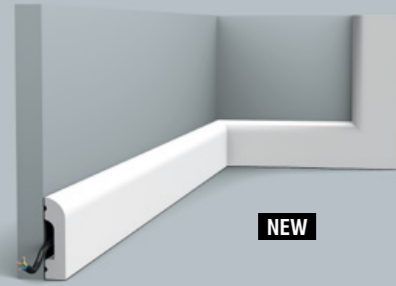

NEW
DX182-2300 | DX182F
CASCADE
230 x 5 x 1,3 cm (DX182-2300)
Duopolymer®
200 x 5 x 1,3 cm (DX182F)

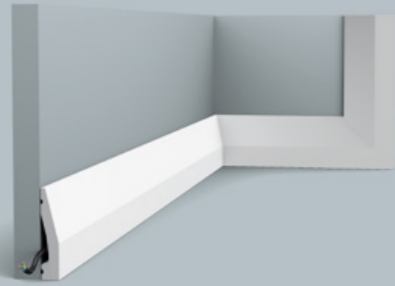

DX159-2300
230 x 6 x 1,2 cm
Duopolymer®

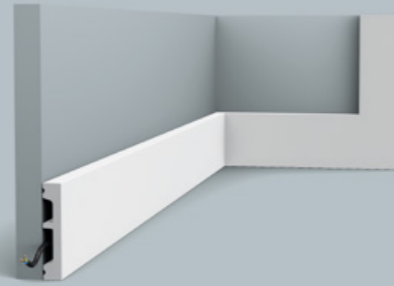

DX157-2300 | DX157F
SQUARE
230 x 6,6 x 1,3 cm (DX157-2300)
Duopolymer®
200 x 6,6 x 1,3 cm (DX157F)

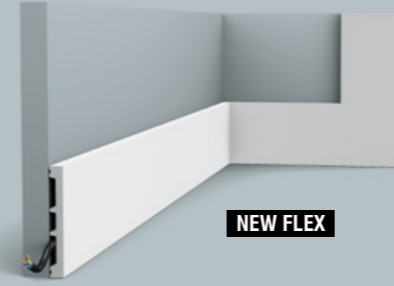

NEW FLEX
DX163-2300 | DX163F
SQUARE
230 x 10,2 x 1,3 cm (DX163-2300)
Duopolymer®
200 x 10,2 x 1,3 cm (DX162F)

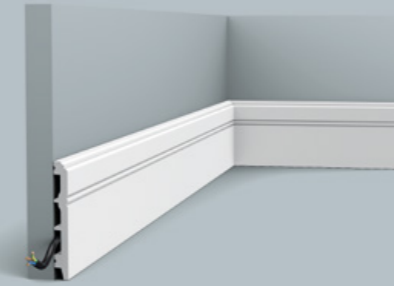

SX105 | SX105F
200 x 10,8 x 1,3 cm
Duopolymer®



SX155 | SX155F
200 x 10,8 x 2,5 cm
Duopolymer®

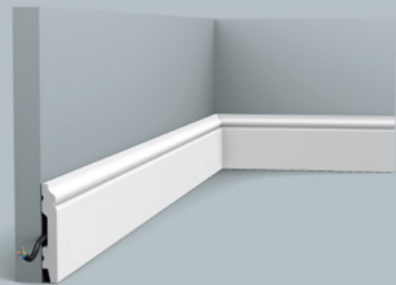

SX165 | SX165F
CONTOUR
200 x 6,9 x 1,1 cm
Duopolymer®

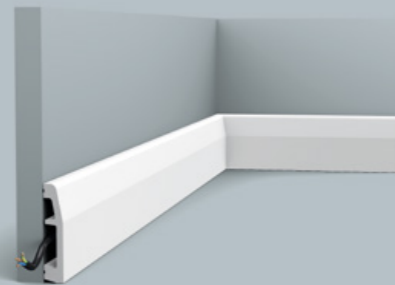

SX125
200 x 6,9 x 1,4 cm
Duopolymer®

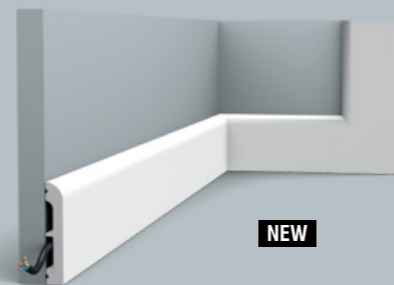

NEW
DX183-2300 | DX183F
CASCADE
230 x 7,5 x 1,3 cm (DX183-2300)
Duopolymer®
200 x 7,5 x 1,3 cm (DX183F)

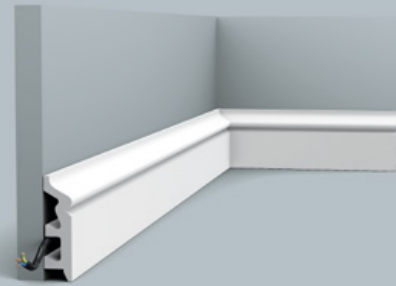

SX122
200 x 7,9 x 2,2 cm
Duopolymer®

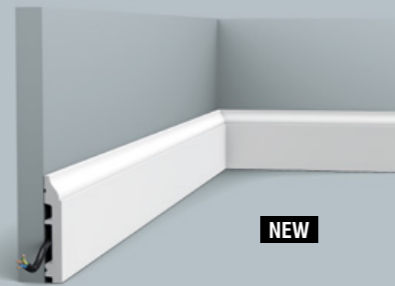

NEW
SX172 | SX172F
200 x 8,5 x 1,4 cm
Duopolymer®

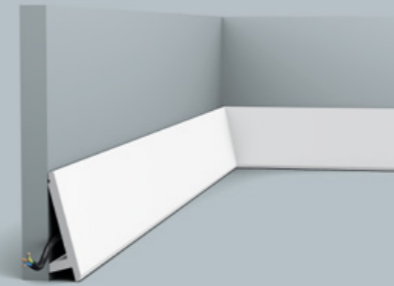

SX179 | SX179F DIAGONAL
200 x 9,7 x 2,9 cm
Duopolymer®
Designed by
Orio Tonini

α = 9,8



- 1 P8020 p. 106
- 2 P8050 p. 108
- 3 SX118 p. 120

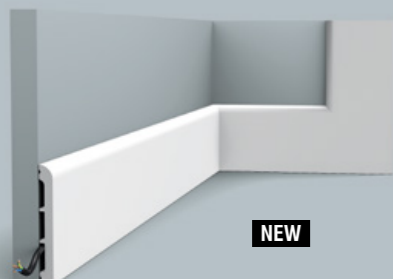

DX184-2300 | DX184F
CASCADE
230 x 11 x 1,3 cm (DX184-2300)
Duropolymer®
200 x 11 x 1,3 cm (DX184F)

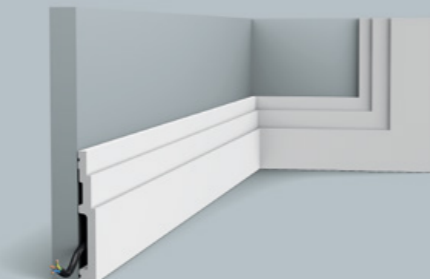
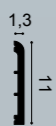

1 SX180 | SX180F
HIGH LINE
200 x 12 x 1,6 cm
Duropolymer®

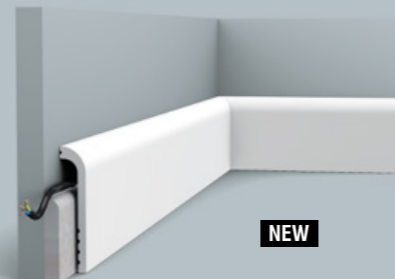
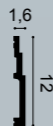

SX185
CASCADE
200 x 12 x 2,5 cm
Duropolymer®

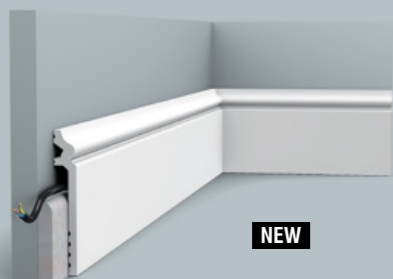
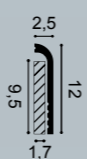

SX186
CONTOUR
200 x 13,8 x 2 cm
Duropolymer®

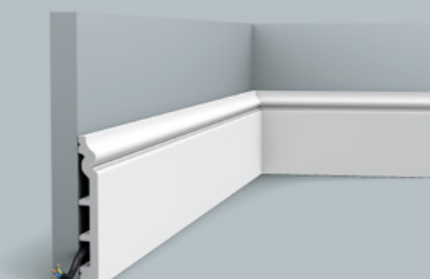
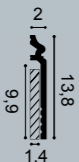

SX118 | SX118F
CONTOUR
200 x 13,8 x 1,8 cm
Duropolymer®

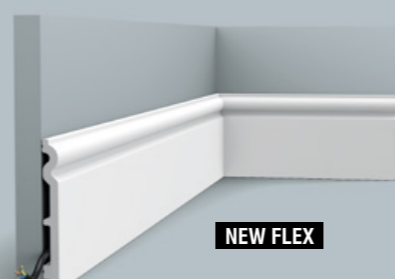

SX138 | SX138F
200 x 13,8 x 1,5 cm
Duropolymer®

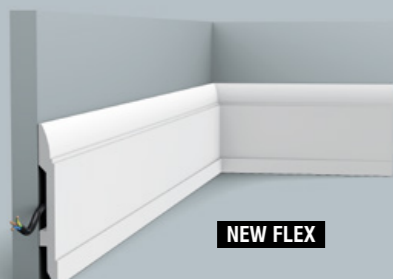

SX104 | SX104F
200 x 14,8 x 1,7 cm
Duropolymer®

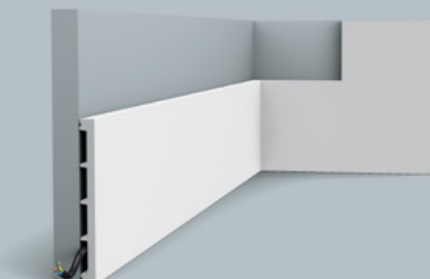

DX168-2300
SQUARE
230 x 15,1 x 1,4 cm
Duropolymer®

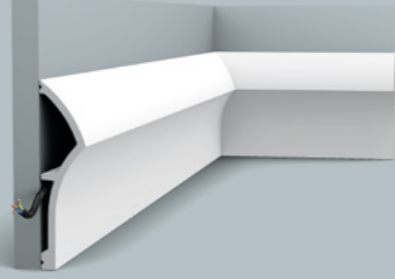
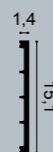

SX167 DUNE
200 x 17,3 x 4,3 cm
Duropolymer®
Designed by Ulf Moritz

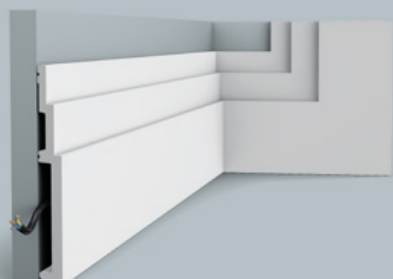

SX181 HIGH LINE
200 x 20 x 2,2 cm
Duropolymer®



SX156 HIGH HEELS
200 x 20,2 x 1,6 cm
Duropolymer®
Designed by
Xavier Donck



Cover Skirting

COPRI BATTISCOPIA / RODAPÉ DE SOBREPOSIÇÃO
PLINTA DE ACOPERIRE / KRYCÍ PODLAHOVÁ LIŠTA

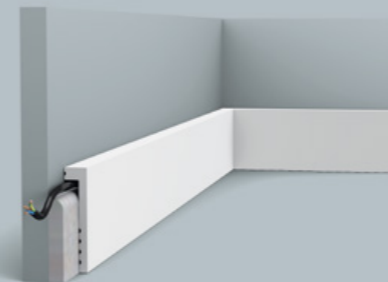

SX171 SQUARE
200 x 10 x 2,2 cm
Duropolymer[®]

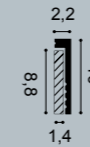

2 SX185 CASCADE
200 x 12 x 2,5 cm
Duropolymer[®]

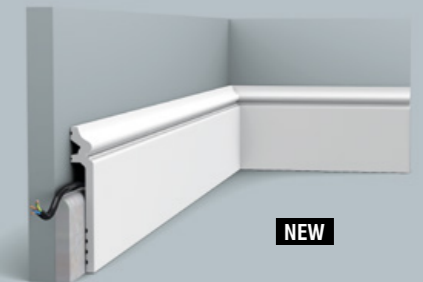
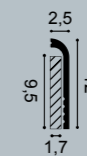

SX186 CONTOUR
200 x 13,8 x 2 cm
Duropolymer[®]



PAINTABLE
Verniciabile
Pintável
Vopsibil
Přetíratelné



WATER RESISTANT
Resistente all'acqua
Resistente à água
Rezistent la apă
Voděodolné



IDEAL FOR RENOVATIONS
Ideale per le ristrutturazioni
Ideal para renovações
Ideal pentru revovari
Ideální pro renovace



3 PX175 p.111



1 SX118 p.120

Multifunctional

MULTIFUNZIONALE / MULTIFUNCIONAL
MULTIFUNȚIONAL / MULTIFUNKČNÍ

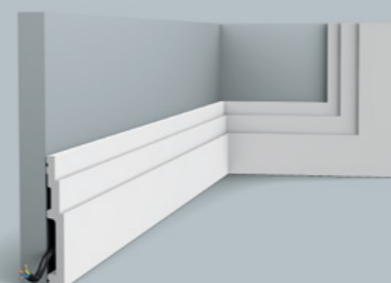

**SX180 | SX180F
HIGH LINE**
200 x 12 x 1,6 cm
Duropolymer[®]

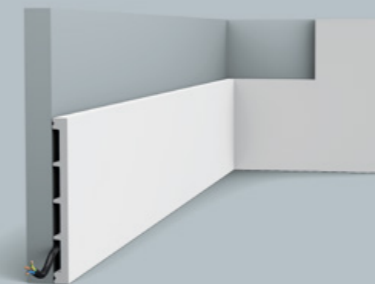

DX168-2300 SQUARE
230 x 15,1 x 1,4 cm
Duropolymer[®]

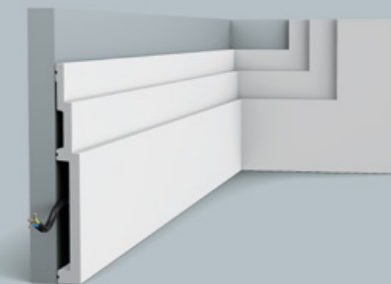

SX181 HIGH LINE
200 x 20 x 2,2 cm
Duropolymer[®]

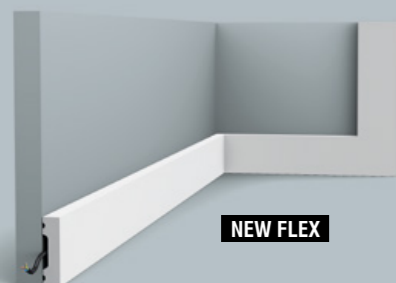

**DX162-2300 | DX162F
SQUARE**
230 x 4 x 1 cm (DX162-2300)
Duropolymer[®]
200 x 4 x 1 cm (DX162F)

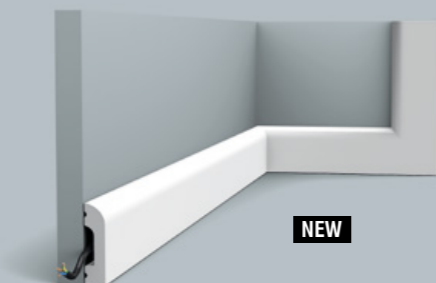

**DX182-2300 | DX182F
CASCADE**
230 x 5 x 1,3 cm (DX182-2300)
Duropolymer[®]
200 x 5 x 1,3 cm (DX182F)

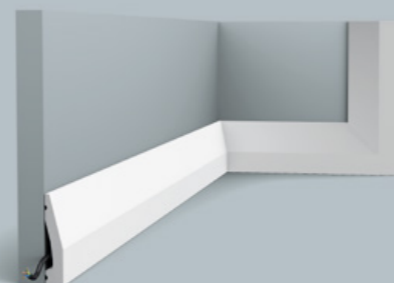

DX159-2300
230 x 6 x 1,2 cm
Duropolymer[®]

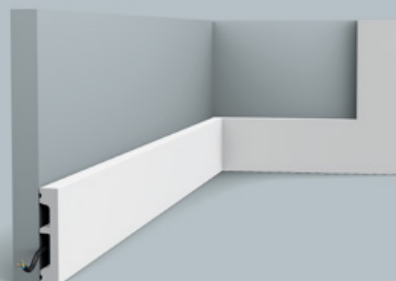

**DX157-2300 | DX157F
SQUARE**
230 x 6,6 x 1,3 cm (DX157-2300)
Duropolymer[®]
200 x 6,6 x 1,3 cm (DX157F)

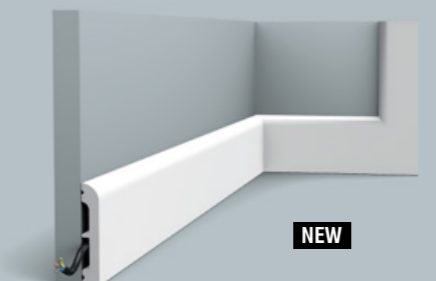

**DX183-2300 | DX183F
CASCADE**
230 x 7,5 x 1,3 cm (DX183-2300)
Duropolymer[®]
200 x 7,5 x 1,3 cm (DX183F)

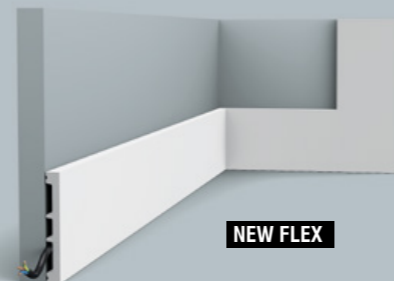
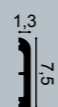

**DX163-2300 | DX163F
SQUARE**
230 x 10,2 x 1,3 cm (DX163-2300)
Duropolymer[®]
200 x 10,2 x 1,3 cm (DX162F)

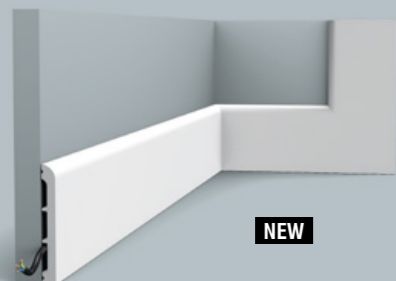
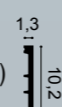

**DX184-2300 | DX184F
CASCADE**
230 x 11 x 1,3 cm (DX184-2300)
Duropolymer[®]
200 x 11 x 1,3 cm (DX184F)

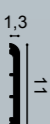

en

Profiles with endless possibilities. Each element can be used as a panel moulding, cornice moulding, door surround or as skirting board.

it

Profili con infinite possibilità d'uso. Lo stesso elemento può essere utilizzato sia come cornice soffitto, cornice parete, contorno porta e come battiscopa.

pt

Perfis com infinitas possibilidades. O mesmo elemento pode ser utilizado como perfil, sanca, moldura de porta e rodapé.

ro

Profile cu posibilități nesfârșite. Unul și același element poate fi folosit ca brau, cornisă, ancadrament de ușă și ca plintă.

cz

Profily s mnohostranným využitím. Ten samý prvek může být použit jako lemovací, stropní lišta, dveřní obložka tak i podlahová lišta.



Indirect Lighting

ILLUMINAZIONE INDIRETTA / ILUMINAÇÃO INDIRETA
ILUMINATUL INDIRECT / NEPŘÍMÉ OSVĚTLENÍ

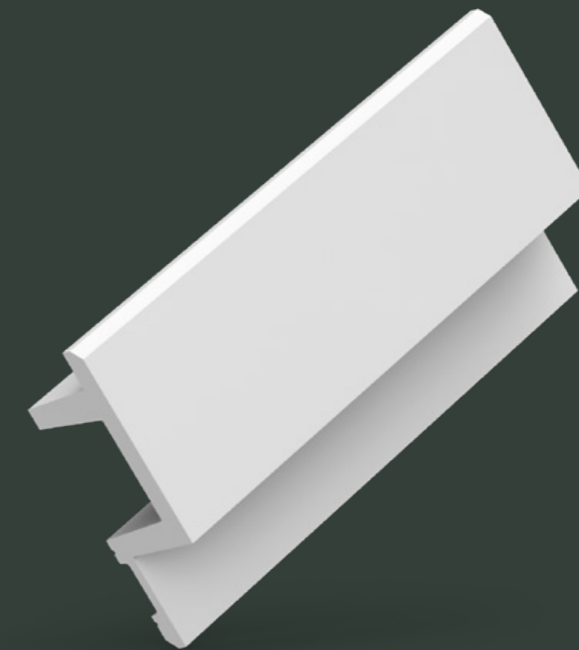
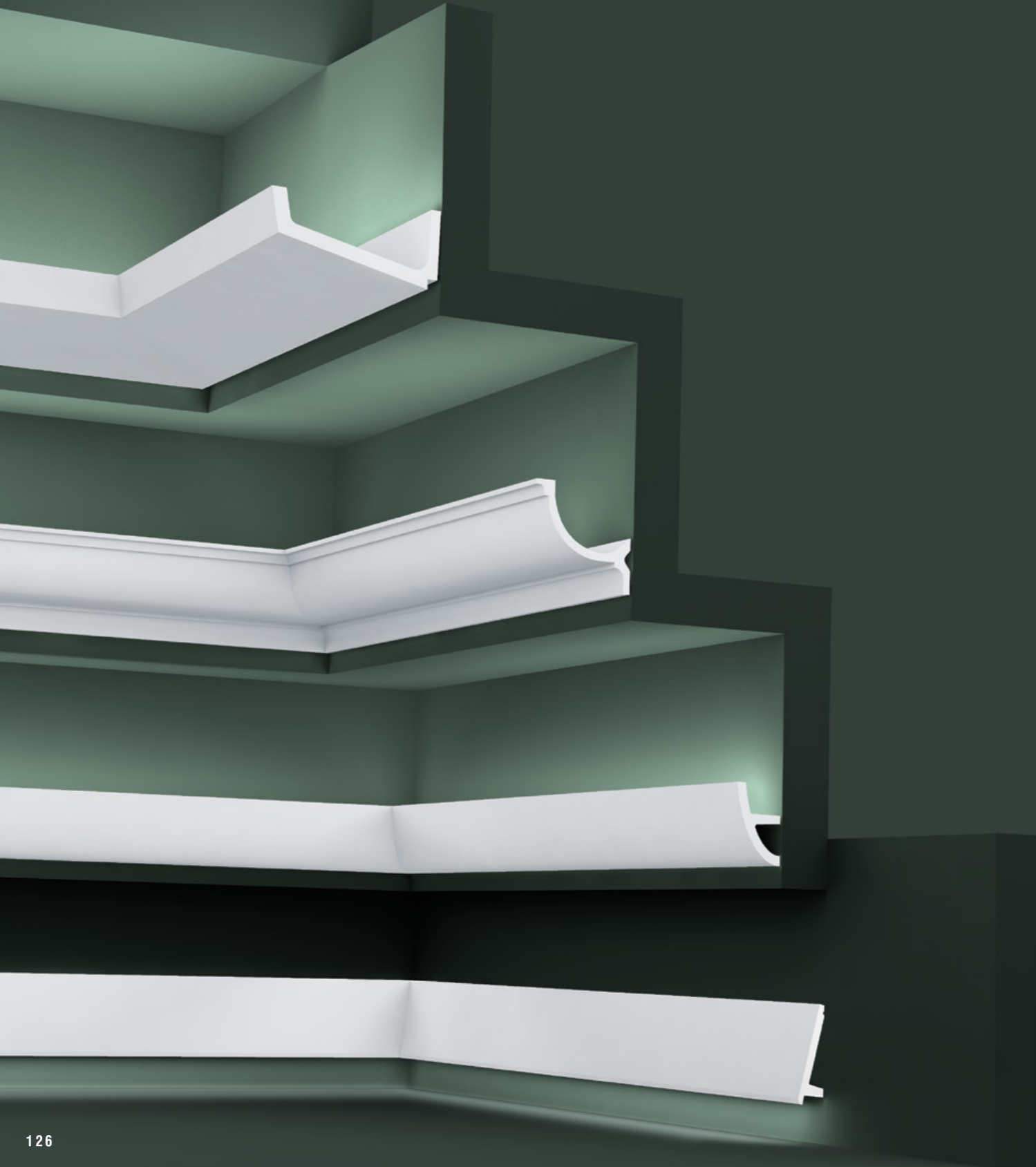

en

Indirect lighting imparts a warm atmosphere and creates an extra spatial effect. Whether tautly linear or diffuse, as uplight or downlight, one thing is certain: it enhances the architecture. What's more, the compact LED lighting ensures an energy-efficient and durable solution.

it

Indispensabile per l'atmosfera, l'illuminazione indiretta crea un'illusione di spazio aggiuntivo. Che sia lineare o diffusa, con la luce rivolta verso il basso o verso l'alto, l'illuminazione indiretta sottolinea senza dubbio l'architettura degli interni. Grazie all'illuminazione a LED compact, si ha a disposizione una soluzione economica e di lunga durata.

pt

A iluminação indireta proporciona um ambiente acolhedor e cria um efeito de espaço. Seja linear ou difusa, de cima ou de baixo, uma coisa é clara: realça a arquitetura do espaço interior. Além disso, os LED de iluminação compacta garantem uma solução eficiente em termos de energia e durabilidade.

ro

Iluminatul indirect confera o atmosfera calda si creeaza un efect de mai mult spatiu. Fie ca este rectiliniu sau difuz, in sus sau in jos, un lucru este clar: acesta imbunatateste arhitectura. Si mai mult, iluminatul cu LED asigura o solutie energetica eficienta si durabila.

cz

Nepřímé osvětlení navozuje příjemnou atmosféru a vytváří efekt většího prostoru. Ať je přímočaře lineární nebo difúzní, instalované jako horní nebo spodní osvětlení, jedno je jisté: zvýrazňuje architekturu. A co víc, kompaktní LED osvětlení poskytuje úsporné a trvanlivé řešení.

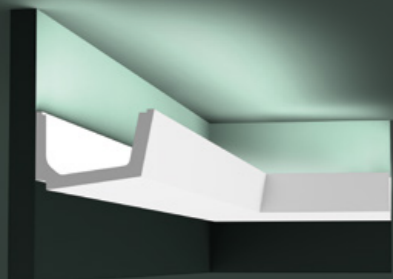

C357 STRAIGHT

200 x 7,1 x 11 cm
Purotouch®

Designed by
Jacques Vergracht

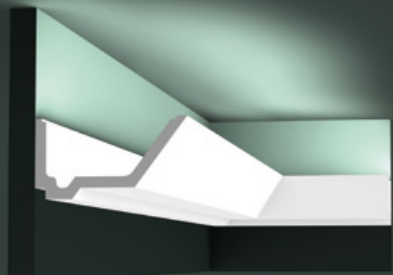

C358 RAIL

200 x 7,3 x 14 cm
Purotouch®

Designed by
Jacques Vergracht

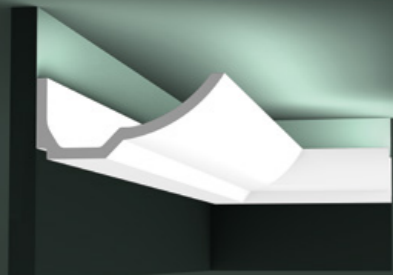

C351 BOAT

200 x 7,4 x 17,3 cm
Purotouch®

Designed by
Jacques Vergracht

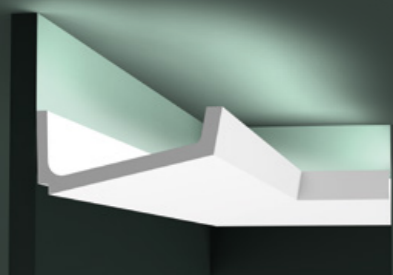

C352 FLAT

200 x 7,6 x 17,1 cm
Purotouch®

Designed by
Jacques Vergracht

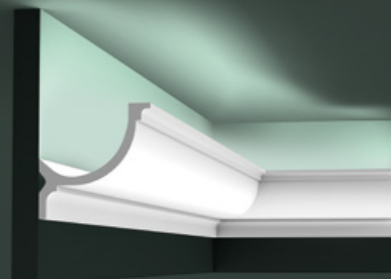
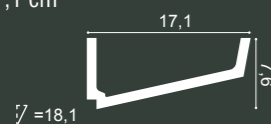

C902 | C902F

200 x 10,3 x 10,3 cm
Purotouch®

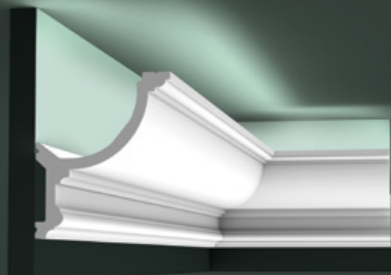
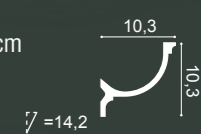

C901 | C901F

200 x 14,8 x 12,4 cm
Purotouch®

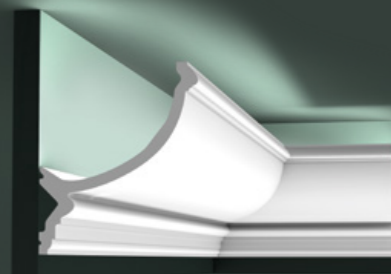
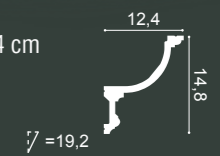

C900

200 x 17,1 x 14,6 cm
Purotouch®

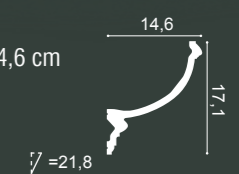

L3 Lighting Combinations

INDIRECT LIGHTING / ILLUMINAZIONE INDIRECTA / ILLUMINAÇÃO INDIRETA / ILLUMINATUL INDIRECT / NEPRÍMÉ OSVĚTLENÍ

C380

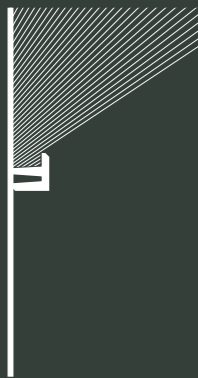

C382 + C380

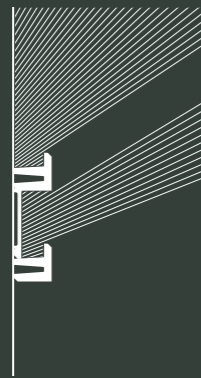

③ C382 + C382 + C380

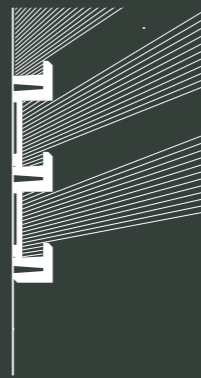

C382 + C382 + C381

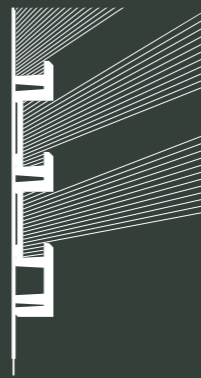

C381

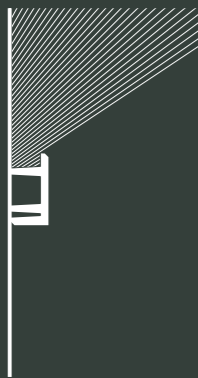

C383 + C381

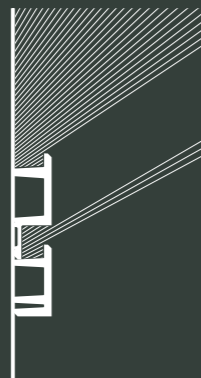

C383 + C383 + C381

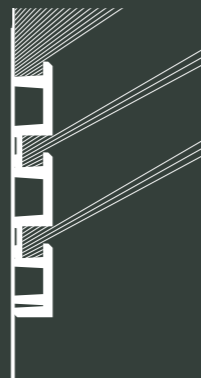

C383 + C382 + C381

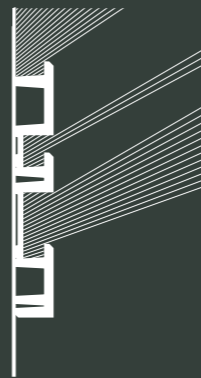

C382 + C383

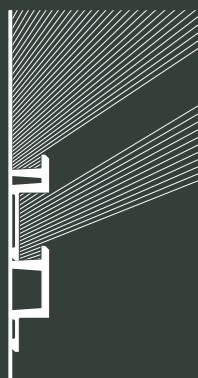

C381 + C382

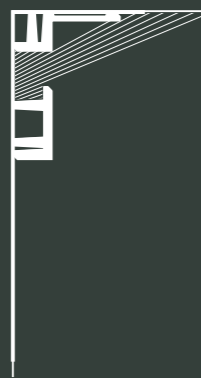

C382 + C382



① C382 + C382 + C382

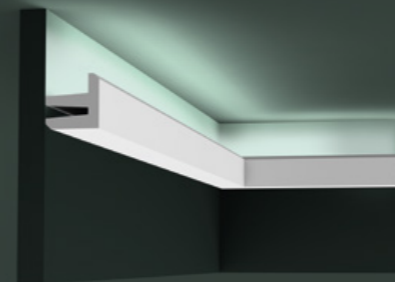
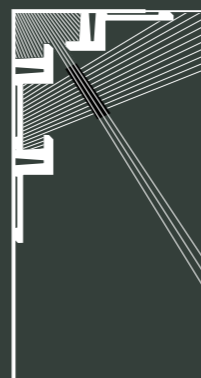

C380 L3 Linear Led Lighting

200 x 5 x 5 cm
Purotouch®
Designed by
Orio Tonini

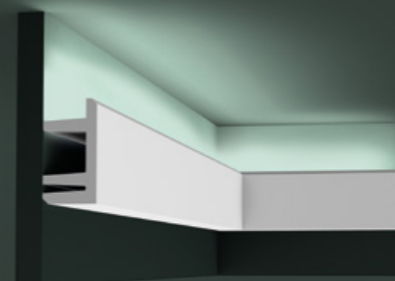
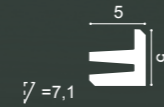

C381 L3 Linear Led Lighting

200 x 9,5 x 5 cm
Purotouch®
Designed by
Orio Tonini

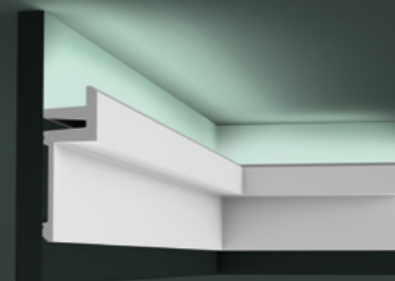
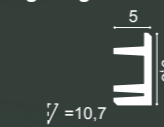

C382 L3 Linear Led Lighting

200 x 14 x 5 cm
Purotouch®
Designed by
Orio Tonini

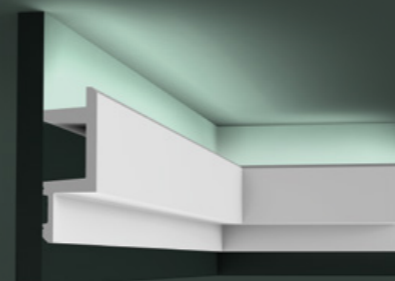
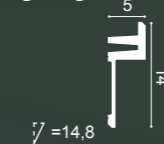

② C383 L3 Linear Led Lighting

200 x 14 x 5 cm
Purotouch®
Designed by
Orio Tonini

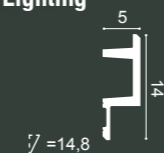

INDIRECT LIGHTING / ILLUMINAZIONE INDIRECTA / ILLUMINAÇÃO INDIRETA / ILLUMINATUL INDIRECT / NEPRÍMÉ OSVĚTLENÍ

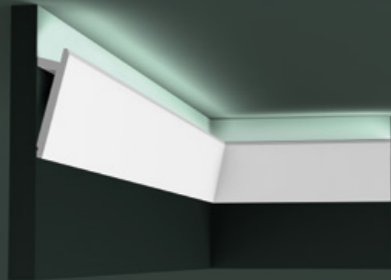
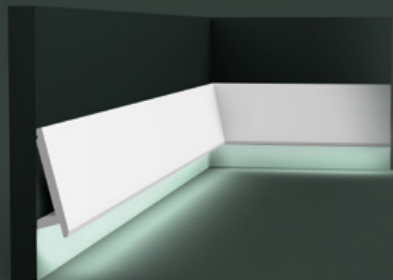

USE
ALUMINIUM
PROFILE
FOR LED



SX179 | SX179F DIAGONAL

200 x 9,7 x 2,9 cm
Duropolymer®

Designed by
Orio Tonini

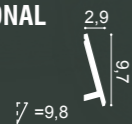

1 SX179 | SX179F DIAGONAL

200 x 9,7 x 2,9 cm
Duropolymer®

Designed by
Orio Tonini

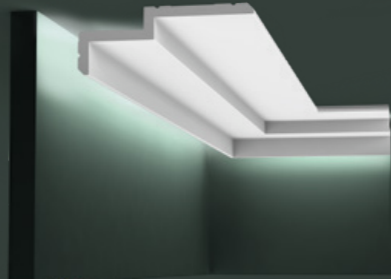
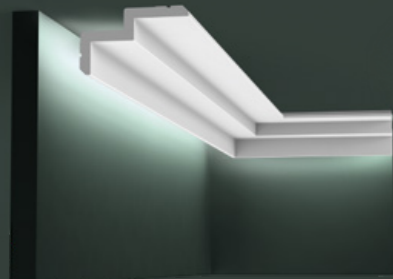

C390

200 x 6 x 10 cm
Purotouch®

Designed by
Orio Tonini

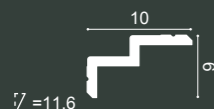

C391

200 x 6 x 16 cm
Purotouch®

Designed by
Orio Tonini

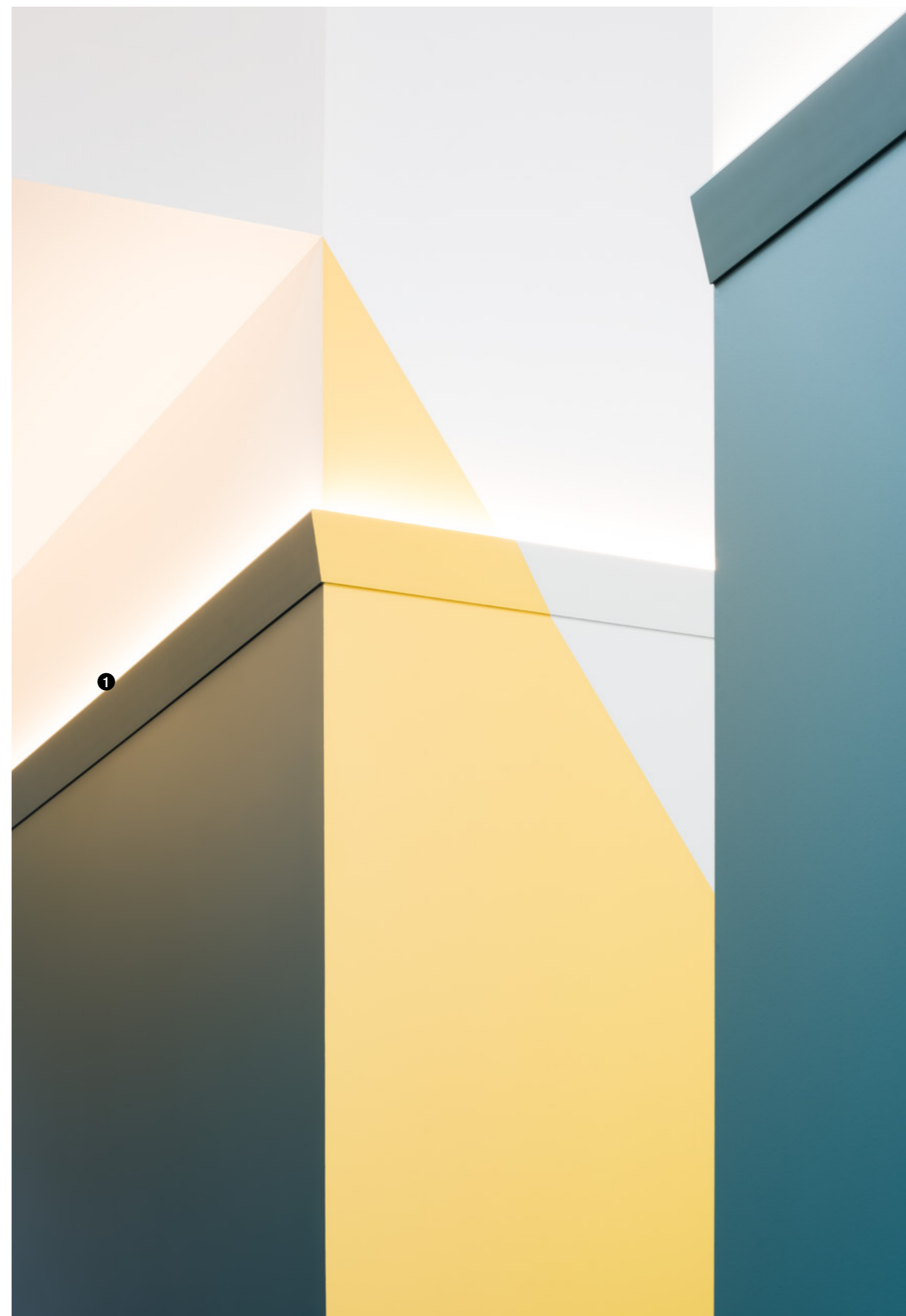
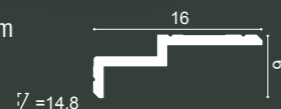

ULF MORITZ

FOR
ORAC[®]
DECOR

1 C373 | C373F ANTONIO

200 x 8 x 5 cm
Purotouch[®]

Designed by
Ulf Moritz

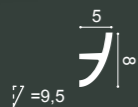

$\sphericalangle = 9,5$

2 C374 | C374F ANTONIO

200 x 18 x 5 cm
Purotouch[®]

Designed by
Ulf Moritz

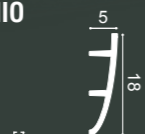

$\sphericalangle = 18,6$

C373 + C374



C373 + C373

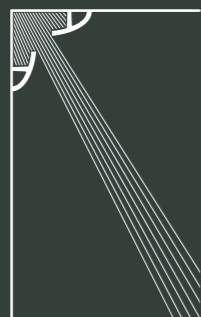

C374 + C991

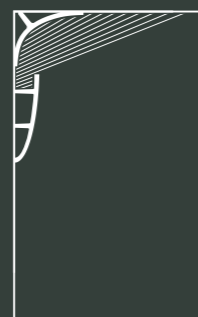

C373 + C373

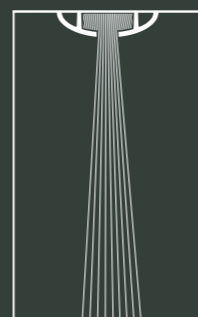

C374 + C374

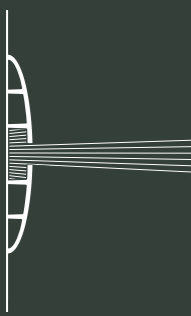

C373 + C374

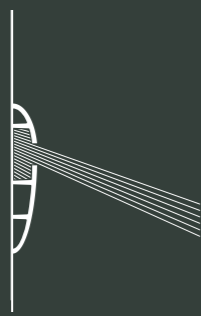

C373 + C373

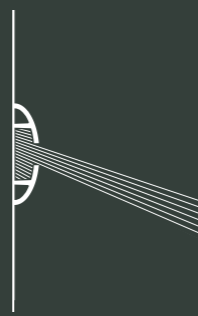

C374 + C373



C373 + C374

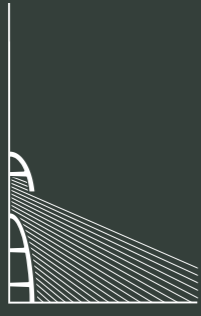

C374 + C374



C373 + SX167



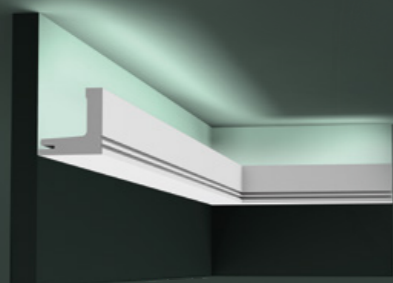

C361 STRIPE

200 x 5 x 5 cm
Purotouch®
Designed by
Pierre Daems

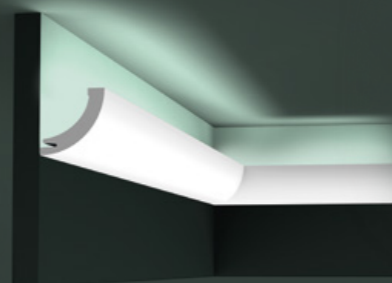
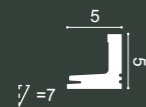

C362 CURVE

200 x 5 x 5 cm
Purotouch®
Designed by
Pierre Daems

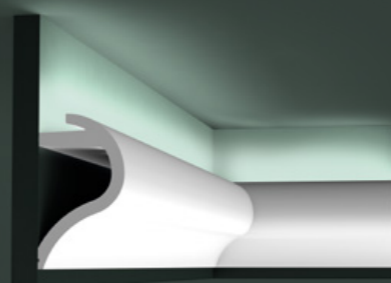
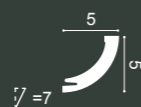

C364 WAVE

200 x 14 x 8 cm
Purotouch®
Designed by
Pierre Daems

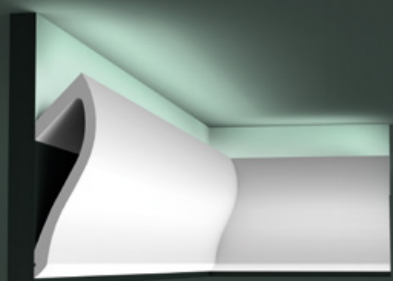
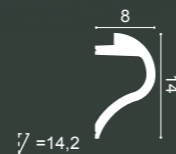

C371 SHADE

200 x 18,5 x 5,8 cm
Purotouch®
Designed by
Ulif Moritz

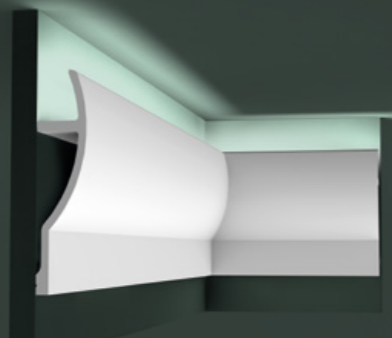
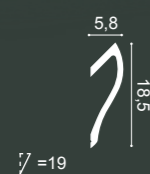

C372 FLUXUS

200 x 28 x 7 cm
Purotouch®
Designed by
Ulif Moritz

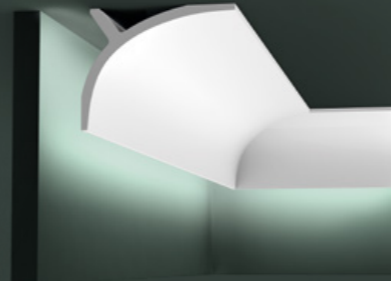

C991

200 x 11 x 14 cm
Purotouch®

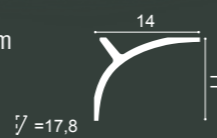

INDIRECT LIGHTING / ILLUMINAZIONE INDIRETTA / ILLUMINAÇÃO INDIRETA / ILLUMINATUL INDIRECT / NEPRÍMÉ OSVĚTLENÍ

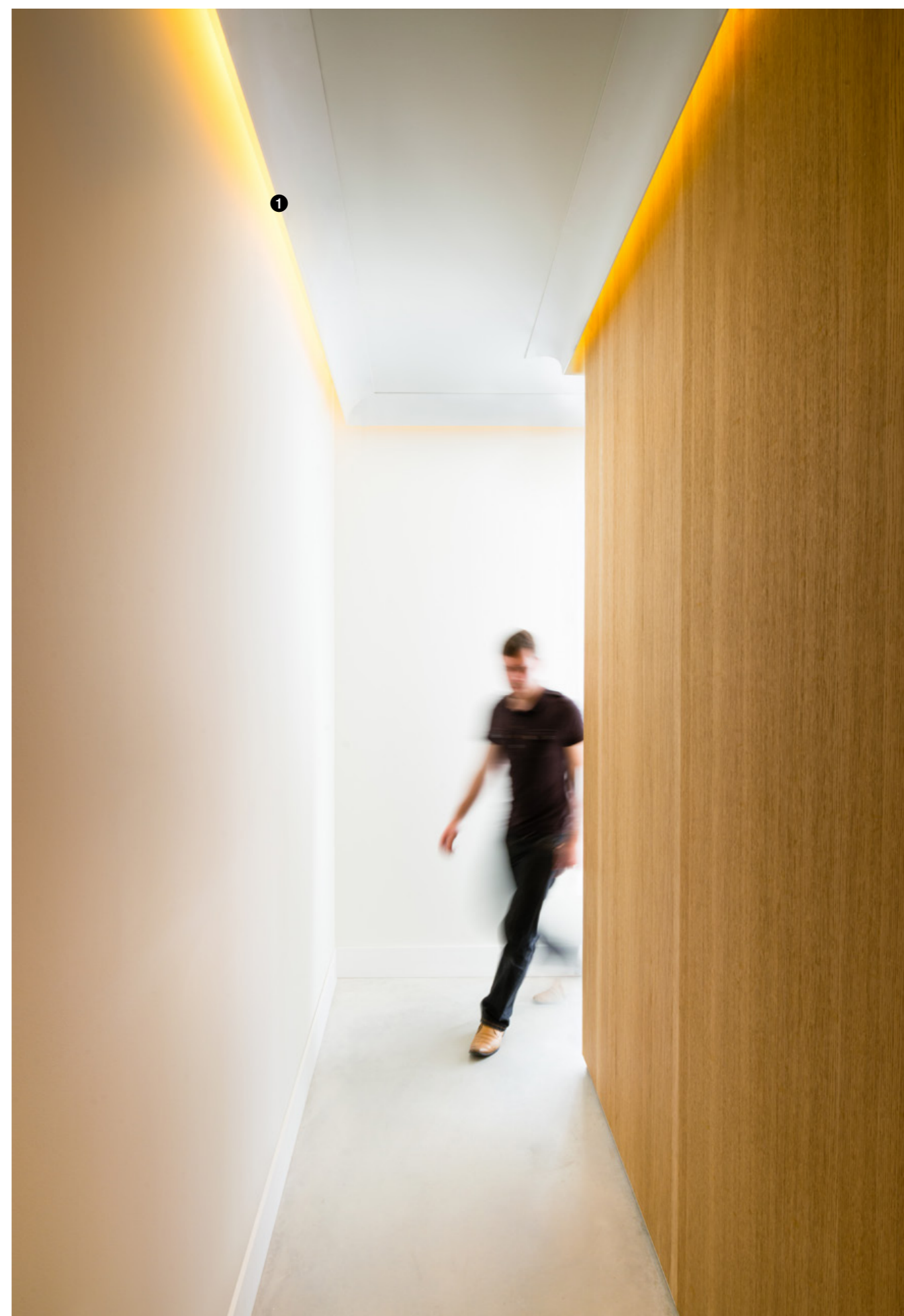

INDIRECT LIGHTING / ILLUMINAZIONE INDIRETTA / ILLUMINAÇÃO INDIRETA / ILLUMINATUL INDIRECT / NEPRÍMÉ OSVĚTLENÍ

Deco Elements

ELEMENTI DECORATIVI / ELEMENTOS DECORATIVOS
ELEMENTE DECORATIVE / DEKORATIVNÍ PRVKY

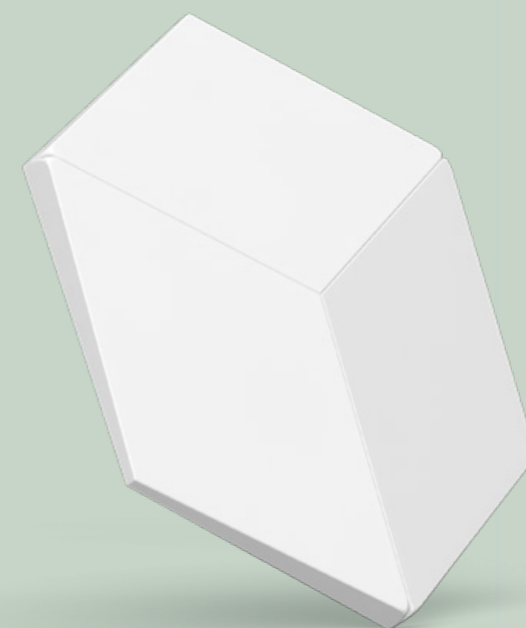
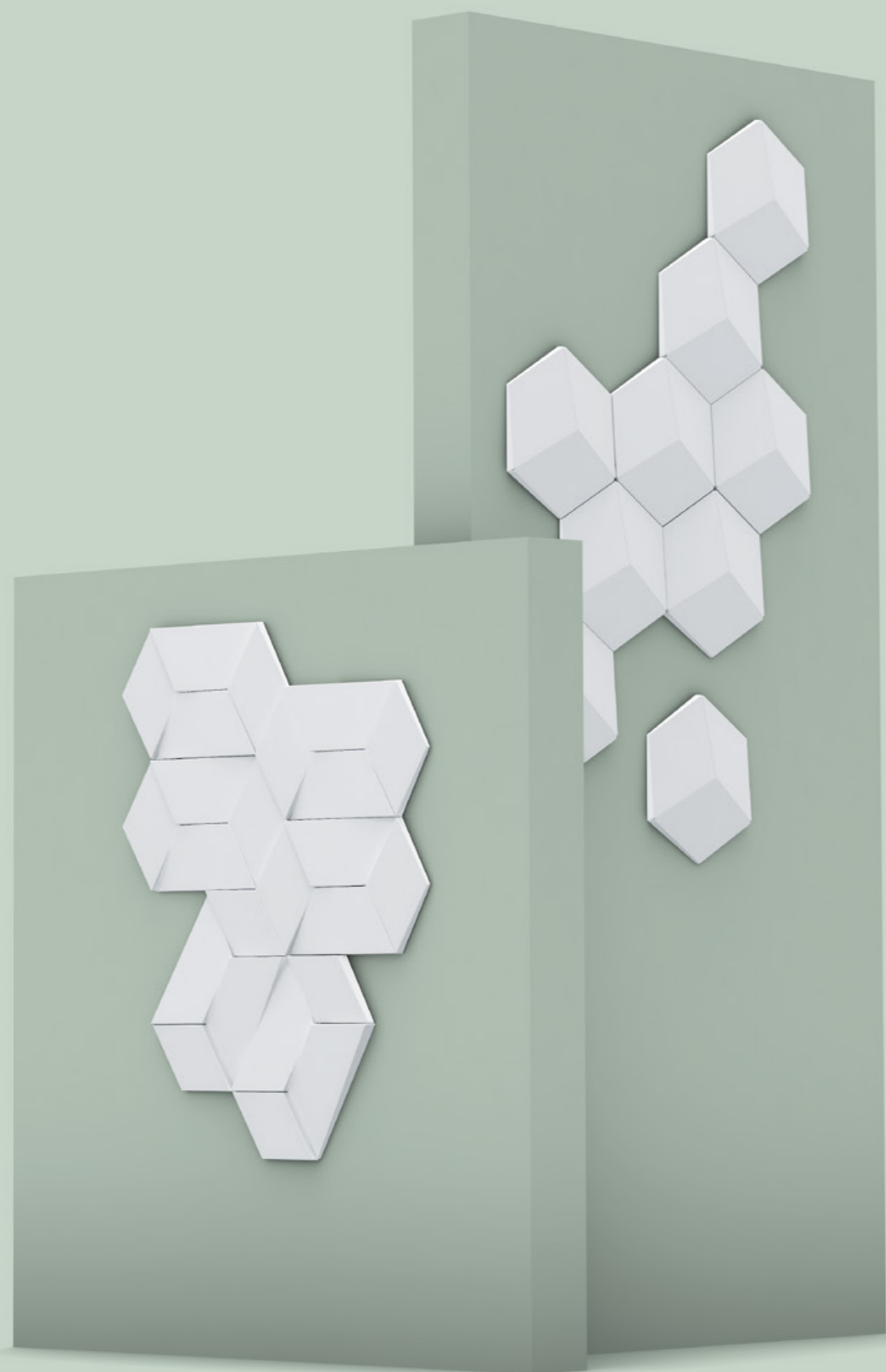

en

Follow your imagination. Understated and dignified classic interiors, can be created with our Deco elements. The sleek, modern designs suit contemporary homes, by adding a dramatic 3D form. The elements of these ornaments allow considerable opportunities to personalize any room.

it

Lasciate libera la vostra immaginazione. Se siete alla ricerca di un risultato sobrio ed elegante per un interno classico, di una finitura moderna per una casa contemporanea o di un originale effetto in 3D, avete trovato la soluzione giusta. Gli elementi decorativi proposti consentono infinite opportunità per rendere unico ogni ambiente.

pt

Siga a sua imaginação. Procura interiores elegantes e dignificantes num ambiente clássico, simples e contemporâneo num apartamento moderno ou prefere um design 3D de fantasia? Todos estas opções podem ser criadas com os nossos elementos decorativos. Os designs elegantes e modernos podem ser adequados a casas contemporâneas ou o inverso. Os elementos decorativos permitem oportunidades consideráveis para personalizar cada espaço, tornando cada decoração única.

ro

Urmeaza-ti imaginatia. Un interior sobru si clasic poate fi creat cu elementele noastre Deco. Pot fi adaugate elemente 3D intr-o casa cu design contemporan? Elementele acestor decoratiuni permit personalizarea oricarei camere.

cz

Následujte svou představivost. S pomocí našich dekorativních prvků je možné vytvořit umírněné i důstojné klasické interiéry. Je možné doplnit hladké, moderní designy současných domovů dramatickými 3D tvary? Prvky těchto ornamentů poskytují mnoho možností k přizpůsobení se libovolné místnosti.

3D WALL PANELS



2 W100 ROMBUS
25,8 x 15 x 2,9 cm
Purotouch[®]

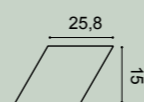

1 W101 TRAPEZIUM
34,5 x 15 x 2,9 cm
Purotouch[®]

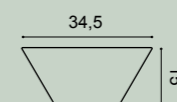

W105 ROMBUS
30 x 34,6 x 3 cm
Purotouch[®]

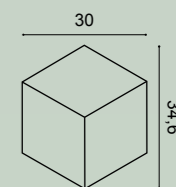



1 W104 KILT

45 x 45 x 3,6 cm
Purotouch®
Designed by
Orio Tonini

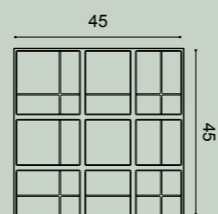

2 W102 CUBI

33,3 x 33,3 x 2,5 cm
Purotouch®

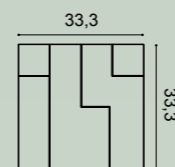

3 W103 CUBI

33,3 x 33,3 x 2,5 cm
Purotouch®

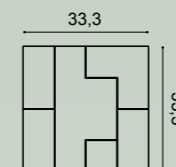

CEILING ROSES / ROSONI / CENTROS DE TETO / ROZETE / ROZETY



R10 ⊕
ø 15 x 4,2 - ø 2 cm
Purotouch[®]



R11
ø 19 x 3,6 - ø 3 cm
Purotouch[®]



R12 ⊕
ø 19,5 x 1,8 - ø 1 cm
Purotouch[®]



R07
ø 26 x 3 - ø 5 cm
Purotouch[®]



R08
ø 38 x 4,2 - ø 5 cm
Purotouch[®]



R13 ⊕
ø 28 x 3,1 - ø 2,5 cm
Purotouch[®]



R14 ⊕
ø 33 x 3 - ø 2,5 cm
Purotouch[®]



R31 ⊕
ø 38,5 x 2,7 - ø 3,5 cm
Purotouch[®]



R61
ø 40 x 3,1 - ø 2,5 cm
Purotouch[®]



R17 ⊕
ø 47 x 3,5 - ø 6,5 cm
Purotouch[®]



R09 ⊕
ø 48,5 x 3,7 - ø 6 cm
Purotouch[®]



R18
ø 49 x 4,7 - ø 7 cm
Purotouch[®]



R46 ⊕
ø 53,5 x 4,2 - ø 3 cm
Purotouch®



R66
ø 54,5 / 43 x 2,4 cm
Purotouch®



R76
ø 62 x 4,1 - ø 10,5 cm
Purotouch®



R27
ø 75 x 4,5 - ø 9 cm
Purotouch®



R22
77,5 x 53 x 3,6 cm
Purotouch®



R24
ø 79 x 6 - ø 8 cm
Purotouch®



R77
ø 62 x 4,2 - ø 10,5 cm
Purotouch®



R52 ⊕
ø 69,5 x 4,8 - ø 12,5 cm
Purotouch®



R73 ⊕
ø 70 x 5,9 - ø 8 cm
Purotouch®



R64 ⊕
ø 95,2 x 4,8 - ø 7 cm
Purotouch®

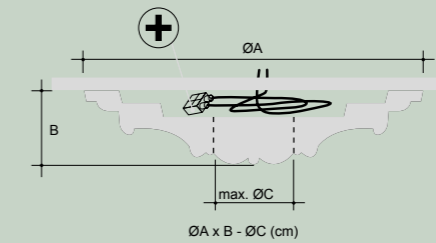

⊕ ROOM FOR CABLES
Spazio per i cavi
Espaço para cabos
Spatiu pentru cabluri
Prostor pro kabely

CEILING ORNAMENTS / DECORAZIONE SOFFITTO / DECORAÇÕES PARA TETO
ORNAMENTE DECORATIVE PENTRU TAVAN / STROPNÍ DEKORATIVNÍ PRVKY



R38
ø 71 x 4,2 - ø 19 cm
Purotouch®



R23
ø 71 x 4,4 - ø 6 cm
Purotouch®



R40 ⊕
ø 74,5 x 3,1 - ø 10 cm
Purotouch®

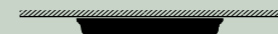

F30
59,5 x 59,5 x 4,3 cm
Purotouch®

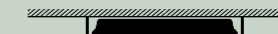
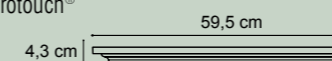

F31
59,5 x 59,5 x 6,6 cm
Purotouch®

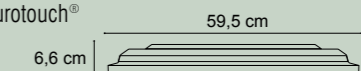

DECO ELEMENTS / ELEMENTI DECORATIVI / ELEMENTOS DECORATIVOS
ELEMENTE DECORATIVE / DEKORATIVNÍ PRVKY



G78 LILY
8,8 x 4,4 x 1,9 cm
Duropolymer[®]
Designed by
Ulf Moritz



G76 SCALA
17,8 x 8 x 1,5 cm
Purotouch[®]
Designed by
Ulf Moritz



G77 LILY
19,4 x 8,8 x 1,8 cm
Duropolymer[®]
Designed by
Ulf Moritz

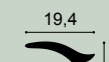

G70 FOLIO
20 x 9 x 2,7 cm
Duropolymer[®]
Designed by
Ulf Moritz

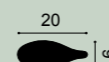

G72 SMILE
42,5 x 6,8 x 1 cm
Duropolymer[®]
Designed by
Ulf Moritz

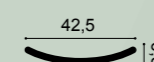

G75 SCALA
27 x 21 x 1,4 cm
Purotouch[®]
Designed by
Ulf Moritz



G71 SCALA
42,2 x 35 x 1,5 cm
Purotouch[®]
Designed by
Ulf Moritz

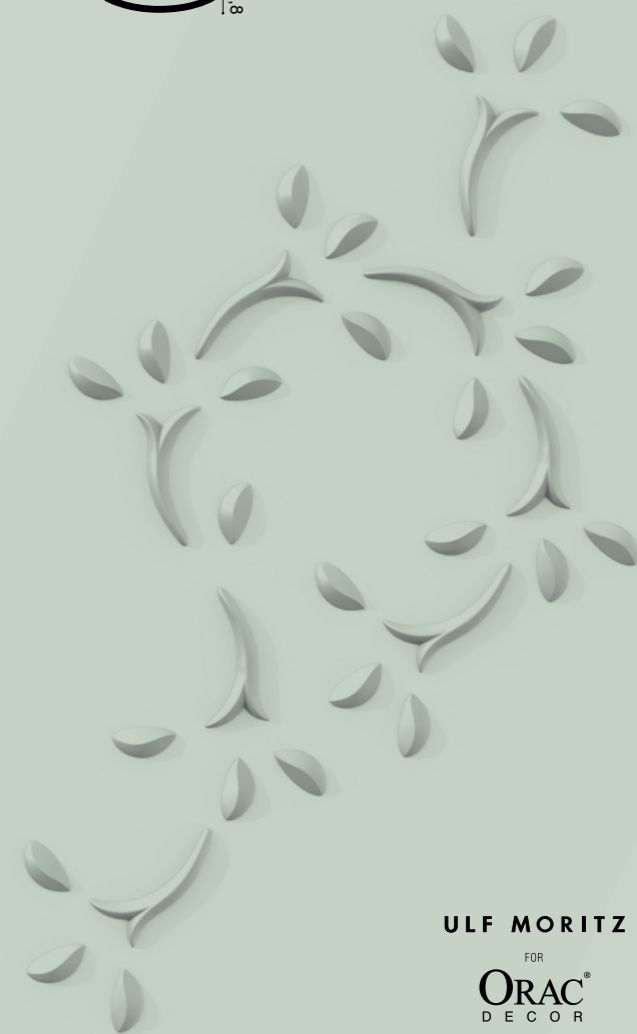

ULF MORITZ
FOR
ORAC[®]
DECOR



DOOR FRAMES / CONTORNI PORTA / MOLDURAS DE PORTA
ANCADRAMENTE DE USI / DVEŘNÍ RÁMY

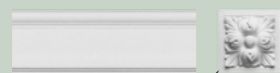

D210
9,6 x 9,6 x 3,5 cm
Duropolymer[®]

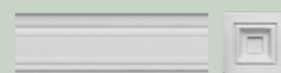

D200
9,6 x 9,6 x 3 cm
Duropolymer[®]

DX121-2300

230 x 9,4 x 2,3 cm
Duropolymer[®]

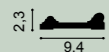

DX119-2300

230 x 9,2 x 2,2 cm
Duropolymer[®]

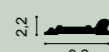

D310

9,5 x 24,9 x 3,1 cm
Duropolymer[®]

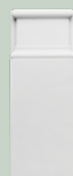

D310

9,5 x 24,9 x 3,1 cm
Duropolymer[®]



DX170-2300

230 x 11,9 x 3,2 cm
Duropolymer[®]



NEW

DX174-2300

230 x 6 x 2,2 cm
Duropolymer[®]

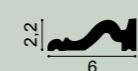

D330LR (2pc)
12,6 x 16 x 4,1 cm
Duropolymer[®]



D340 NEW
7 x 11 x 2,5 cm
Duropolymer[®]



PEDIMENTS / FRONTONI / FRONTÕES / FRONTOANE / ŘÍMSY



D400
127,5 x 14,5 x 5,5 cm
Purotouch[®]



D401
127,5 x 14,5 x 5,5 cm
Purotouch[®]



D402
15 x 12,1 x 5,8 cm
Purotouch[®]
(only for D400 and D401)



D170
105 x 24,5 x 3,2 cm
Purotouch[®]

PANELLING / PANNELI / PAINÉIS DECORATIVOS
BRAURI / OBKLADY

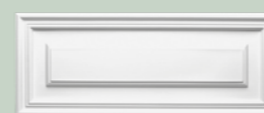

D504
55 x 22 x 1,7 cm
Duropolymer[®]



D503
55 x 55 x 1,7 cm
Duropolymer[®]



D506
43 x 43 x 1,7 cm
Duropolymer[®]



D507
55 x 90,5 x 1,7 cm
Duropolymer[®]

FULL COLUMNS / COLONNE INTERE
COLUNAS COMPLETAS / COLOANE INTREGI
PLNÉ SLOUPY

HALF COLUMNS / MEZZE COLONNE
MEIAS COLUNAS / COLOANE JUMATATI
POLOVIČNÍ SLOUPY

PILASTERS / PILASTRI / PILASTRAS / PILASTRI / PILASTRY

DECO ELEMENTS / ELEMENTI DECORATIVI / ELEMENTOS DECORATIVOS / ELEMENTE DECORATIVE / DEKORATIVNÍ PRVKY

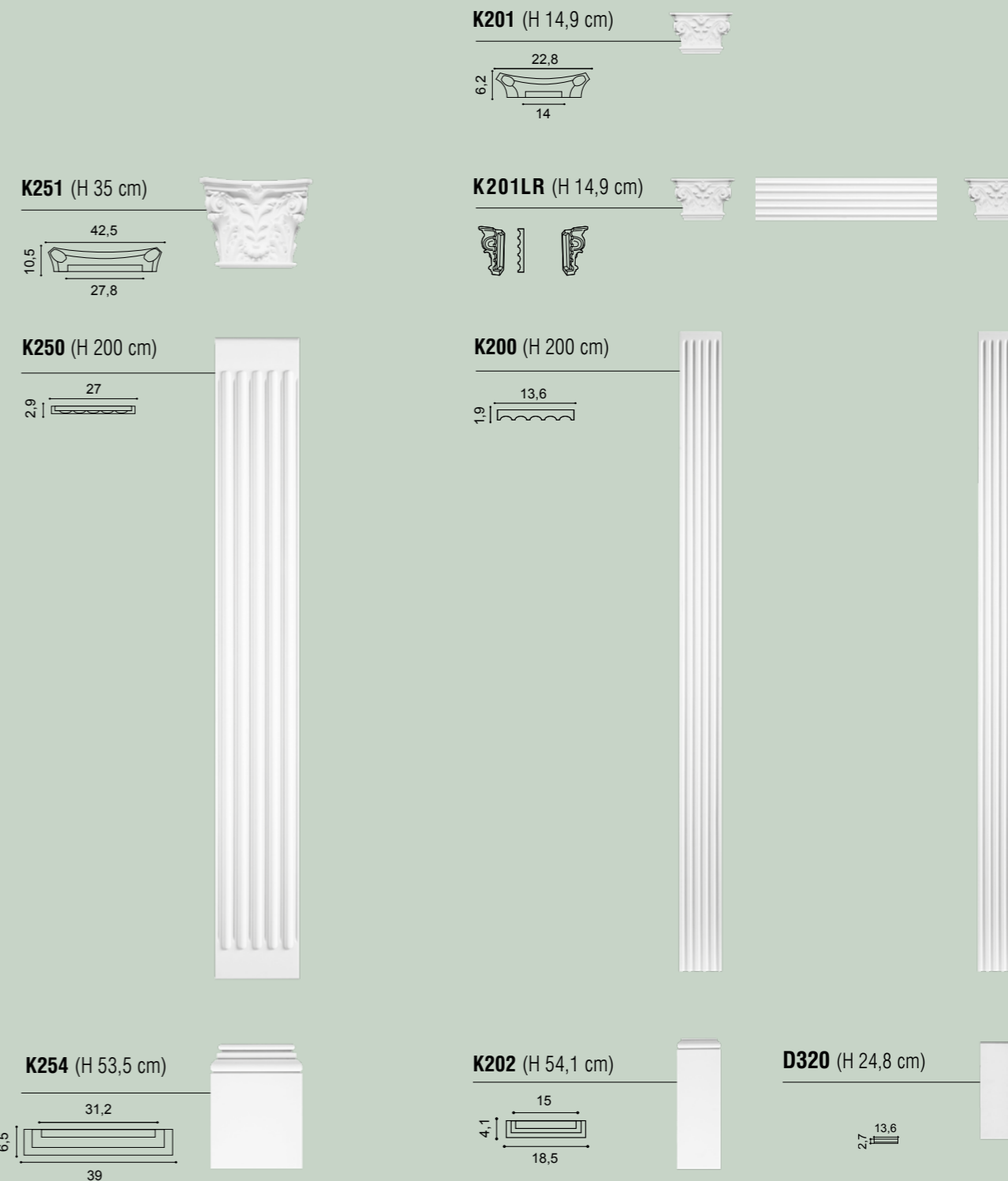
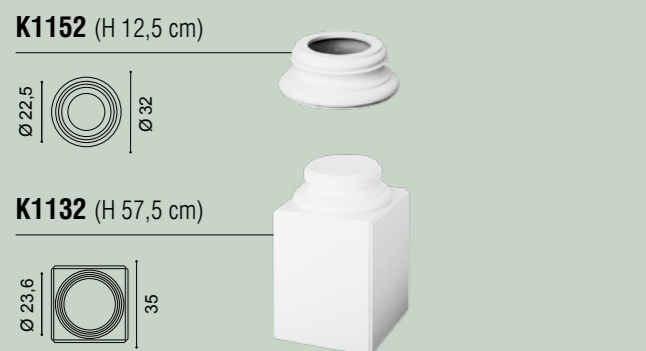
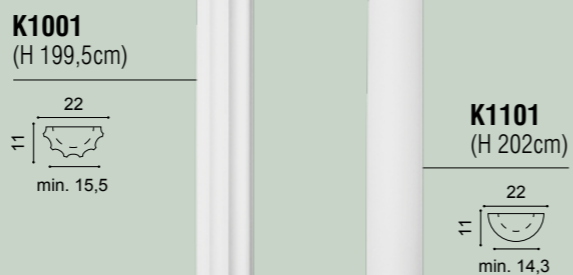
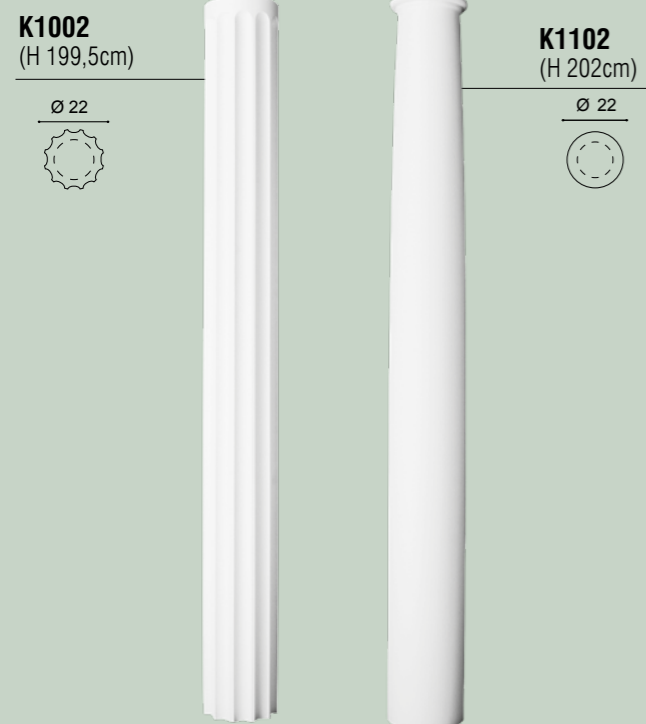
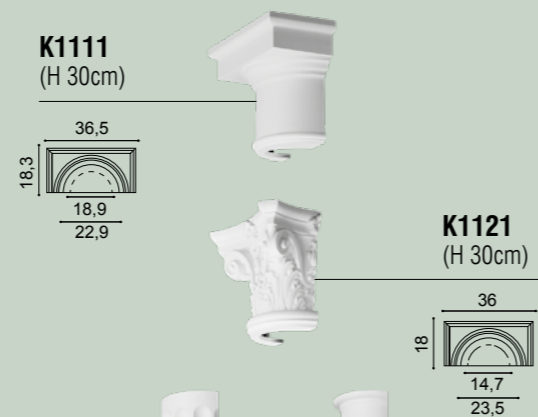

DECO ELEMENTS / ELEMENTI DECORATIVI / ELEMENTOS DECORATIVOS / ELEMENTE DECORATIVE / DEKORATIVNÍ PRVKY

K1112 + K1002 + K1152 = 242 cm H
K1112 + K1002 + K1132 = 287 cm H max
K1122 + K1102 + K1152 = 242 cm H
K1122 + K1102 + K1132 = 287 cm H max

K1111 + K1001 + K1151 = 242 cm H
K1111 + K1001 + K1131 = 287 cm H max
K1121 + K1101 + K1151 = 242 cm H
K1121 + K1101 + K1131 = 287 cm H max

The Perfect Finish

La finitura perfetta / O acabamento perfeito
Finisare perfecta / Perfektní zakončení

Ready? Set? Go!



ONLY FULL GUARANTEE WITH DECOFIX
GARANZIA COMPLETA SOLO CON COLLANTE DECOFIX
GARANTIA COMPLETA APENAS COM DECOFIXVOLLSTÄNDIGE GARANTIE
GARANTIE COMPLETA DOAR FOLOSIND DECOFIX
PLNÁ ZÁRUKA POUZE S LEPIDLEM DECOFIX

Ready?

SURFACE & ATMOSPHERE

Ambiente & Superficie | Ambiente & Superficie | Suprafata & Ambient | Povrch & podmínky



Storage and installation conditions: Store profiles and adhesives at room temperature and wait 24 hours before installing.

Condizioni di installazione e stoccaggio: Tenere i profili e il collante a temperatura ambiente almeno 24 ore prima della posa.
 Condições de armazenamento e instalação: guardar os perfis e as colas no local 24 horas antes da aplicação.
 Conditii de depozitare si instalare: depoziteaza profilele si adezivii la temperatura camerei cu 24h inainte de instalare.
 Skladovací a instalační podmínky: skladujte profily a lepidla v pokojové teplotě a vyčkejte 24 hod než začnete instalovat.



Dust free
 Libero da polvere
 Livre de pó
 Fara praaf
 Bez prachu

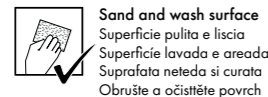

Sand and wash surface
 Superficie pulita e liscia
 Superficie lavada e areada
 Suprafata neteda si curata
 Obrušte a očistěte povrch



Flat wall & ceilings
 Muri e soffitti piani
 Paredes e tetos lisos
 Perete & tavan plat
 Rovná stěna & strop

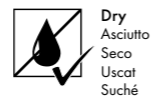

Dry
 Asciutto
 Seco
 Uscat
 Suché

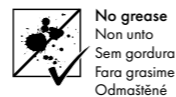

No grease
 Non unto
 Sem gordura
 Fara grasime
 Odmaštěné

Set?

DECOFIX ADHESIVES

Collanti Decofix | Colas DecoFix | Adezivi Decofix | Decofix lepidla

Interior, porous and dry surface
 Per interni, superfici porose, ambienti asciutti
 Interior, superficies porosas e secas
 Suprafata la interior, poroasa si uscata | Pro
 použití v interiéru, porézni a suchý povrch



Exterior, non-porous and humid surface
 Per esterno, superfici non porose, ambienti umidi
 Exterior, superficies não porosas e ambientes
 húmidos | Suprafata la exterior, non-poroasa si
 umeda | Pro použití v exteriéru, neporézni a vlhký
 povrch



Seal wall / ceiling
 Incollaggio su muri e soffitti
 Colar a tetos/paredes
 Inchidere perete / tavan
 Stěna & strop

DecoFix Pro
 Strong, water-based acrylic installation adhesive

FDP500 310ml | 7 > 8m
 FDP600 4200ml | 65 > 110m

or
of
ou
oder
o

DecoFix Hydro
 Very strong MS-Polymer-based installation adhesive

FDP700 290ml | 7 > 8m

Joints between moldings*
 Unione delle giunte dei profili
 Uniãoes dos perfis
 Imbinarile dintre profile
 Spojce mezi listami

DecoFix Extra
 Polyurethane-based adhesive

FX200 310ml | min. 80m
 FX210 tube 80ml | min. 20m

*** For Durofoam®: use DecoFix Pro for joints**
 Per Durofoam®: usare Decofix Pro per le giunte | Para Durofoam®: use
 DecoFix Pro para as uniões das peças | Pentru Durofoam®: foloseste DecoFix
 Pro la imbinari | Durofoam®: použijte DecoFix pro spoje

ACCESSORIES | Accessori | Acessórios | Accesorii | Příslušenství

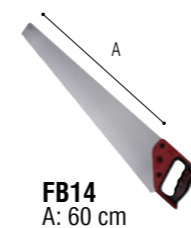
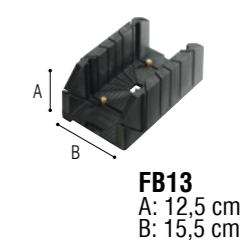
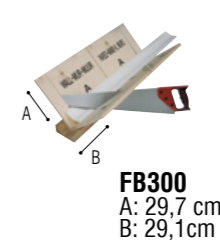

Go!



INSTALLATION VIDEOS & MANUALS
 DECOFIX GLUE CALCULATOR

SCAN THE QR CODE OR
 VISIT WWW.ORACDECOR.COM > INSTALLATION

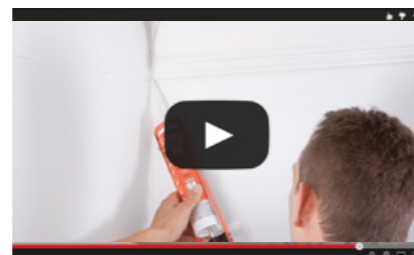

Flexible Products

Flex Radius	R min in cm	R* min in cm	Flex Radius	R min in cm	R* min in cm	Flex Radius	R min in cm	R* min in cm
C200F	160		C602F	100		P9020F	30	
C201F	200		C901F	600		P9040F	30	80
C211F	250		C902F	600		P9050F	20	60
C212F	120		CX100F	200		P9900F	20	250
C213F	280		CX106F	360		P9901F	20	180
C214F	140		CX109F	160		PX103F	20	80
C215F	160		CX110F	180		PX120F	30	110
C216F	340		CX123F	280		PX144F	20	220
C217F	380		CX124F	160		PX175F	30	80
C218F	360		CX127F	240		DX157F	35	260
C220F	400		CX132F	70		DX162F	20	80
C230F	150		CX148F	180		DX163F	35	
C240F	270		P1020F	30	80	DX174F	60	300
C250F	70		P2020F	30	80	DX182F	35	
C260F	130		P3020F	50	180	DX183F	40	
C301F	320		P4020F	40	200	DX184F	45	
C302F	250		P5020F	30		SX104F	40	
C303F	180		P5021F	20	70	SX105F	30	
C304F	250		P6020F	30	250	SX118F	40	
C308F	120		P7010F	20		SX137F	40	
C321F	140		P7020F	30		SX138F	40	
C322F	160		P7030F	30	250	SX155F	30	
C331F	420		P7040F	40	320	SX165F	40	
C333F	300		P7070F	30	230	SX172F	35	
C334F	380		P8020F	40	130	SX173F	45	
C339F	380		P8030F	20	70	SX179F	35	
C341F	400		P8040F	30		SX180F	45	
C373F	100		P8050F	80	200			
C374F	130		P8060F	80	200			
C402F	300		P9010F	40	310			

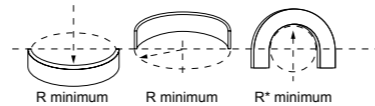

Discover our flexible collection.
Scopri la nostra collezione di profili flessibili.
Descubra a nossa coleção flexível.
Descopera produsele flexibile.
Objevte kolekci ohebných lišt.

WWW.ORACDECOR.COM



en

A wide range of cornice mouldings, panel mouldings and skirting boards are available to give curved walls and ceilings an elegant finish. These elements are also light and can be painted.

The sky is the limit: add curved lines and circles to your walls and ceilings in no time.

it

Una vasta gamma di cornici soffitto, cornici parete e battiscopa disponibili anche nella versione flessibile per decorare pareti e soffitti curvi in modo elegante. Anche questi elementi sono leggeri e possono essere verniciati.

Non avresti mai immaginato che sarebbe stato così facile decorare con linee curve e cerchi muro e soffitto.

pt

Uma ampla gama de sancas, perfis e rodapés estão disponíveis para dar a tetos e paredes curvas um acabamento elegante. Estes elementos são também leves e pintáveis.

O céu é o limite: adicione linhas curvas e círculos às suas paredes e tetos com rapidez.

ro

O gamă largă de cornișe, brauri și plinte sunt disponibile pentru a oferi pereților și plafoanelor curbate o finisare elegantă. Aceste elemente sunt de asemenea ușoare și pot fi vopsite.

Cerul este limita: adăugați linii și cercuri curbate la pereții și plafoanele dvs. numaidecat.

cz

Široká řada stropních, lemovacích a podlahových lišt je k dispozici k elegantnímu zakončení zaoblených stěn a stropů. Tyto prvky mohou být také přetřány.

Zde není limit, přidejte kdykoliv zaoblené linie a kruhy na vaše stěny stropy.

Index

C

C200 C200F	87
C201 C201F	89
C211 C211F	89
C212 C212F	87
C213 C213F	87
C214 C214F	87
C215 C215F	86
C216 C216F	89
C217 C217F	88
C218 C218F	90
C219	93
C220 C220F	87
C230 C230F	86
C240 C240F	87
C250 C250F	86
C260 C260F	86
C300	93
C301 C301F	93
C302 C302F	90
C303 C303F	90
C304 C304F	89
C305	88
C305 + C211	88
C305 + C213	88
C307	94
C307 + C307A	94
C308 C308F	95
C321 C321F	87
C322 C322F	86
C331 C331F	87
C332	89
C333 C333F	90
C334 C334F	90
C335	95
C336	95
C337	93
C338	94
C338A	94
C338B	94
C339 C339F	90
C340	90
C341 C341F	87, 103
C342	90, 103
C343	94, 103
C344	95
C351	128
C352	128
C353	86
C354	86
C355	86

C356	86
C357	128
C358	128
C360	86
C361	136
C362	136
C364	136
C371	136
C372	136
C373 C373F	134
C374 C374F	134
C380	131
C381	131
C382	131
C383	131
C390	86, 103, 132
C391	87, 103, 132
C392	95
C393	90
C400	87
C402 C402F	88
C422	93
C602 C602F	86
C900	93, 129
C901 C901F	90, 129
C902	129
C902 C902F	87
C990	92
C990 + 2x P9900	92
C990 + P9900	92
C991	89, 103, 136
C991 + 2x P9900	89
C991 + P9900	89
CB500	101
CB501	101
CB502	101
CB503	101
CB510	101
CB511	101
CB512	101
CB520	101
CB521	101
CB522	101
CB523	101
CB530	101
CB531	101
CX100 CX100F	100
CX101	100
CX106 CX106F	100
CX107	100
CX108	99
CX109 CX109F	99
CX110 CX110F	99

CX111	98
CX112	99
CX115	99
CX123 CX123F	100
CX124 CX124F	99
CX126	100
CX127 CX127F	100
CX128	100
CX129	100
CX132 CX132F	98, 118
CX133	98, 118
CX134	110
CX136	100
CX141	99
CX148 CX148F	99
CX150	99
CX151	99
CX154	98
CX160	98
CX161	98
CX176	99
CX177	99

D

D170	151
D200	150
D210	150
D310	150
D320	153
D330LR	150
D340	150
D400	151
D401	151
D402	151
D503	151
D504	151
D506	151
D507	151
DX119-2300	112, 150
DX121-2300	112, 150
DX157-2300	98, 111, 116, 118, 124
DX157F	98, 111, 116, 118, 124
DX159-2300	111, 118, 124
DX162-2300	98, 111, 116, 118, 124
DX162F	98, 111, 116, 118, 124
DX163-2300	98, 112, 116, 119, 124
DX163F	98, 112, 116, 119, 124
DX168-2300	112, 120, 125
DX170-2300	112, 150
DX174-2300 DX174F	111, 150
DX182-2300 D182F	111, 98, 116, 118, 124

DX183-2300	98, 112, 116, 118, 124
DX183F	98, 112, 116, 118, 124
DX184-2300 DX184F	98, 112, 116, 120, 124

F

F30	147
F31	147
FB10	155
FB13	155
FB14	155
FB15	155
FB300	155
FDP100	155
FDP500	155
FDP600	155
FDP700	155
FX200	155
FX210	155

G

G70	149
G71	149
G72	149
G75	149
G76	149
G77	149
G78	149

K

K200	153
K201	153
K201LR	153
K202	153
K250	153
K251	153
K254	153
K1001	152
K1002	152
K1101	152
K1102	152
K1111	152
K1112	152
K1121	152
K1122	152
K1131	152
K1132	152
K1151	152
K1152	152

P

P20 + P101A	113
-------------	-----

P21 + P201A	113
P101A + P1020	113
P201A + P2020	113
P801C + P8020	113
P1020 P1020F	106
P2020 P2020F	106
P3020A + P3020	113
P3020 P3020F	106
P3070	108
P3071	108
P4020A + P4020	113
P4020 P4020F	106
P5020B	113
P5020 P5020F	108
P5021 P5021F	106
P5050	108
P5051	107
P6020 P6020F	106
P7010 P7010F	108
P7020 P7020F	108
P7030 P7030F	107
P7040 P7040F	107
P7070 P7070F	107
P7080	108
P8020 P8020F	106
P8030C + P8030	113
P8030D + P8030	113
P8030 P8030F	106
P8040 P8040F	108
P8050 P8050F	108
P8060 P8060F	106
P9010 P9010F	107
P9020 P9020F	108
P9040 P9040F	106
P9050 P9050F	106
P9900 P9900F	107
P9901 P9901F	106
PB513	101
PX102	112
PX103A + PX103	113
PX103 PX103F	110
PX113	111
PX114	111
PX116	110
PX117	111
PX120A + PX120	113
PX120 PX120F	111
PX131	111
PX144 PX144F	111
PX147	110
PX147 + PX169	110
PX164	100
PX169	110
PX175 PX175F	111

R

R07	145
R08	145
R09	145
R10	145
R11	145
R12	145
R13	145
R14	145
R17	145
R18	145
R22	147
R23	146
R24	147
R27	147
R31	145
R38	146
R40	146
R46	146
R52	146
R61	145
R64	147
R66	146
R73	146
R76	146
R77	146

S

SX104 SX104F	120
SX105 SX105F	119
SX118 SX118F	116, 120
SX122	118
SX125	118
SX137 SX137F	119
SX138 SX138F	120
SX155 SX155F	119
SX156	120
SX165 SX165F	116, 118
SX167	120
SX171	116, 119, 123
SX172 SX172F	118
SX173 SX173F	116, 119
SX179 SX179F	118, 132
SX180 SX180F	120, 125
SX181	120, 125
SX185	116, 120, 123
SX186	116, 120, 123

W

W100	141
W101	141
W102	143
W103	143
W104	142
W105	141

CONCEPT

Bjorn Verlinde
Brando
Gazeuse

GRAPHICS

Gazeuse

SPECIAL THANKS TO

Balo Living in Style	www.balo.be	12, 13, 24, 25
Toon Degruyter	www.toondegruyter.be	12, 13, 24, 25
Eichholtz	www.eichholtz.com	14, 15
Groep Versluys	www.groepversluys.be	16, 17
Naudts Patrick	Belex	22, 23, 35
Perfect Living by Nathalie Bakker	www.perfectliving.be	28, 29, 49
Peckers Pascale	pascale@peckers.me , Ph.: Mireille Roobaert	30, 31
Stadsbader Marie	www.stadsbadermarie.com	34, 82
Interpoint	www.interpoint-antwerpen.be	36, 37
Ignacio Carrasco y Alberto Porras	www.odonnell14.bulthaup.com	40, 41
Koeslag Dennis	info@studiofabels.nl	48, 58, 59
Inmaculada Recio, Silvia Trigueros	www.elerom62.com	51, 66, 67
Patricia Bustos	www.mrsblossom.es	64, 65
De Huiskamer	www.dehuiskamer.be	68, 69
Swyngedauw Nicolas	info@nsdeco.be	68, 69
Esfan Eghtessadi, Inge Onsea	www.essentiel-antwerp.com	70
Van Pamel Frederiek	www.frederiekvanpamel.be	71
Hotel Das Tegernsee	www.dastegernsee.de	72, 73
Pieter Porters	www.houseofporters.com	78, 79
Old School	www.oldschooltechniques.com	78, 79
Maries Corner	www.mariescorner.com	143

Emilie, Anne Gaëlle, Grace, Astrid, Bettina, Antonio, Clément, Peter, Benedikt Vdv,
Verne, Brian Hallett, CASA DECOR Madrid

REGISTERED CTM DESIGN N°

C335/000995576-0001	C372/2088880-0003	CX177/003242569-0010	P9901/000995576-0005
C336/1035273-0001	C373/002524769-0005	D330/002524769-0013	PB513/1890526-0006
C337/1810706-0001	C374/002524769-0006	DX168-2300/002341727-0004	PX147/002341727-0003
C338/1978214-0001	C380/003242569-0001	DX170/002524769-0008	PX169/002341727-0002
C338A/002341727-0007	C381/003242569-0002	DX174-2300/003242569-0011	PX175/003242569-0012
C338B/002341727-0006	C382/003242569-0003	DX182/'004097780-0002	R70/2088880-0006
C339/1978214-0002	C383/003242569-0004	DX183/'004097780-0003	SX156/000995576-0006
C340/1978214-0003	C390/003242569-0005	DX184/'004097780-0004	SX165/002341727-0001
C341/002524769-0001	C391/003242569-0006	G70/002158089-0001	SX167/2088880-0007
C342/002524769-0002	C392/003242569-0007	G71/002158089-0002	SX171/002920140-0001
C343/002524769-0003	C393/003242569-0008	G72/002158089-0003	SX172/003242569-0013
C344/002524769-0004	C990/000995576-0002	G73/002158089-0004	SX173/003242569-0014
C351/000257464-0003	C991/002524769-0009	G75/002524769-0009	SX179/003242569-0015
C352/000257464-0004	CB500/1035273-0006	G76/002524769-0010	SX180/003242569-0016
C353/000257464-0005	CB501/1035273-0005	G77/002524769-0011	SX181/003242569-0017
C354/000257464-0006	CB502/1035273-0007	G78/002524769-0012	SX185/'004097780-0005
C355/000257464-0007	CB503/1890526-0005	P3020A/002341727-0005	SX186/'004097780-0006
C356/000257464-0008	CB510/1035273-0004	P3070/2088880-0004	W100/003356278-0001
C361/1890526-0001	CB511/1035273-0003	P3071/2088880-0005	W101/003356278-0002
C362/1890526-0002	CB512/1890526-0007	P5050/000257464-0001	W102/003356278-0003
C363/1890526-0003	CB523/1035273-0002	P5051/000257464-0002	W103/003356278-0004
C364/1890526-0004	CB530/1890526-0008	P8050/000995576-0003	W104/003356278-0005
C370/2088880-0001	CB531/1890526-0009	P8060/1810706-0002	W105/'004097780-0001
C371/2088880-0002	CX176/003242569-0009	P9900/000995576-0004	

Guarantee terms and conditions apply if provided installation instructions have been followed to the letter. Fire retardant standards. In many interiors and projects strict fire regulations are imposed. Therefore, ORAC has implemented a number of solutions depending on the country and its regulations. Please contact us for more information.

The information in this catalogue is without engagement. Changes and discrepancies in sizes or/and shapes against those stated in the catalogue can occur.

This catalogue and the design embodied within are protected by copyright law and international treaties. Unauthorized reproduction of the catalogue, any portion of it or the reproduction of the designs embodied therein may result in severe civil and criminal penalties and will be prosecuted to the maximum.

Further legal information can be found on: www.oracdecor.com/nl/disclaimer.

ORAC HEADQUARTERS

NV ORAC SA

Biekorfstraat 32
8400 Ostend, BELGIUM
T +32 (0)59 80 32 52
F +32 (0)59 80 28 10
info@oracdecor.com

ORAC NEDERLAND

T 0800-022 2125
F 0800-022 2138
nederland@oracdecor.com

ORAC FRANCE

T 0800-900 358
F +32 (0)59 80 28 10
france@oracdecor.com

ORAC DEUTSCHLAND

T 0800-181 3694
F +32 (0)59 34 05 24
deutschland@oracdecor.com

ORAC (UK) LTD

City Business Centre
Brighton Road, Unit 8
Horsham RH13 5BB - UK
T +44 1403 240 102
F +44 1403 258 686
uk@oracdecor.com

ORAC SLOVAKIA S.R.O.

Kpt. Nalepku 6
08271 Lipany - SK
T +421 (0)514-891 581
F +421 (0)514-573 595
slovakia@oracdecor.com

ORAC SPAIN

C/ Roger de Llúria 67-69 Pral 2^a
08009 Barcelona - ESPAÑA
T 900 99 32 89
spain@oracdecor.com

ORAC RUSSIA

249020, Россия, Калужская область
Боровский район, индустриальный парк Ворсино
ООО «Орак»
info@oracdecor.ru