

The Art of Italian Decoration



Architecture and Design

BOVELACCI

**When you choose
Bovelacci you need
to know why**

from total white to
fashionable colours

smart & style decors

durability and resistance

ready to paint

lightweight and easy cut

INDEX: LINES

AMERICANSTYL	167
“polistrutturato” elements	
BRICKSTYL	265
exterior mouldings	
CLASSICSTYL	13
poliurethane elements	
NEWSTYL	221
high density extruded polymers profiles	
PROFILSTYL	241
skirting and corner profiles	
WOODSTYL	331
poliurethane beams	
ACCESSORIES AND ASSEMBLING INSTRUCTIONS	368

DADO RAILS AND CEILING BORDERS

A01D	178	A10W	179	A46W	181	A90P rear	182
A02D	178	A13W	180	A70W	181		
A03D	179	A35W	180	A90P front	182		

CORNER BLOCKS

AA02OC	186	AA03LP	189	AF02DC	193	AS03OD	197
AA02LG	186	AA10D	190	AF03DC	193	AS03T	198
AA02LP	187	AA10LG	190	AF03DF	194	AT03	198
AA03OG	187	AA10LP	191	AF03DG	194	AR13	199
AA03DP	188	AA13L	191	AA10D	195	AR17	199
AA03LG	188	AC02	192	AS03OS	196		
AA03LM	189	AC03	192	AS0301	196		

CEILING CORNICES

A04C	206	A18C	208	A30T	210	A65C	212
A15C	206	A19C	208	A38C	210	A95D	213
A16C	207	A20C	209	A45C	211		
A17C	207	A22C	209	A50T	212		

WALL PANELING

A28Q	218	A91W front	218	A91W rear	219	A28Q & A91Wr	219
------	-----	------------	-----	-----------	-----	--------------	-----

BRICKSTYL

WINDOW AND DOOR SURROUNDS

BL9202	278	BM9002	279	BM9010	281	BM9013	282
BM9000	278	BM9003	280	BM9011	281	BM9014	283
BM9001	279	BM9009	280	BM9012	282	BM9015	283

BM9016	284	BM9019	285	BM9022	287	BM9025	289
BM9017	284	BM9020	286	BM9023	287		
BM9018	285	BM9021	286	BM9024	289		

WINDOW SILLS

BF9001	293	BF9004	294	BF9012	296	BF9095	297
BF9002	293	BF9010	295	BF9013	296	BF9011	298
BF9003	294	BF9011	295	BF9014	297		

EAVE CORNICES

BF9055	302	BF9020	302	BF9030	303
--------	-----	--------	-----	--------	-----

CORNER PROFILES

BP9004	308	BF9008	309	BF9012	300
BF9006	308	BF9010	309	BF9015	300

EXTERIOR BASEMENT TRIMS

BP9027	314	BP9054	314
--------	-----	--------	-----

PILASTERS

BL9201	318	BL9202	318
--------	-----	--------	-----

CONSOLES - STONES - KEYSTONES

BC9001	322	BB9011	324	BS9001	326	BS9012	328
BC9002	322	BB9020	325	BS9002	327	BS9013	329
BC9005	323	BB9021	325	BS9010	327	BS9014	329
BB9010	324	BB9022	326	BS9011	328		

CEILING CORNICES

C3002	26	C3015	29	C3033	34	C3322	37
C3004	26	C3016	29	C3044	34	C3332	37
C3005	27	C3017	30	C3104	35	C3901	38
C3006	27	C3018	30	C3128	35		
C3008	28	C3019	31	C3203	36		
C3009	28	C3022	31	C3230	36		

COVE LIGHTING

C3215	45	C3217	46	C3225	47	C3227	48
C3216	45	C3218	46	C3226	47	C3228	48

DADO RAILS AND CEILING BORDERS

C3001	54	C3040	55	C3209	57	CL3214	58
C3010	54	C3060	56	C3430	57	CP3510	59
C3012	55	C3120	56	CL3204	58		

CORNER BLOCKS

CA3010	62	CA3120	62	CA3209	63	CF3010	63
--------	----	--------	----	--------	----	--------	----

CEILING CENTERS

CR3305	68	CR3312	69	CR3320	70	CR3324	71
CR3307	68	CR3314	69	CR3321	70	CR3325	71
CR3308	68	CR3315	69	CR3322	70	CR3364	71
CR3311	68	CR3316	69	CR3323	70		

DECORATIVE ELEMENTS

CF3621	83	CF3652	83	CM3823	84	CN3002	85
CF3623	83	CF3654	84	CM3962	84		
CF3624	83	CM3403	84	CN3001	85		

WALL LIGHTING

CD3704	90	CD3705	90	CD3709	91	CD3713	91
--------	----	--------	----	--------	----	--------	----

PILASTERS

CL3200	88	CL3203	89	CL3211	91	CL3213	92
CL3201	88	CL3206	90	CL3212	91	CL3206	93
CL3202	88	CL3206RG	90	CL3213	91	CL3206RP	93
CL3203	88	CL3202	90	CL3205P	92	CL3212	93
CL3205G	89	CL3203	90	CL3211	92	CL3213	93
CL3202	89	CL3210	91	CL3212	92		

LIBRARY DECORATIONS

CB35015	96	CP3502	96	CP3586	96	CP3510	96
B3501D	96	CP3585	96	CP3587	96		

DOOR SURROUNDS

CP3501	101	CP3587	102	CP3514	104	CP3590	106
CP3588	101	CP3511	103	CP3515	104	CP3591	108
CP3510	102	CP3512	103	CP3562	105	CP3592	110

COLUMNS Ø 22,5

CCOL3220	116	CCOL3261	122	CCOL3250	127	CCOL3233	133
CCOL3221	116	CCOL3221	122	CCOL3241	127	CCOL3226	133
CCOL3222	116	CCOL3122	122	CCOL3132	127	CCOL3224	134
CCOL3223	116	CCOL3223	122	CCOL3223	127	CCOL3133	134
CCOL3231	117	CCOL3271	123	CCOL3224	128	CCOL3226	134
CCOL3222	117	CCOL3231	123	CCOL3225	128	CCOL3234	135
CCOL3223	117	CCOL3322	123	CCOL3226	128	CCOL3133	135
CCOL3241	118	CCOL3223	123	CCOL3224	129	CCOL3226	135
CCOL3222	118	CCOL3251	124	CCOL3225	129	CCOL3244	136
CCOL3223	118	CCOL3241	124	CCOL3226	129	CCOL3133	136
CCOL3221	119	CCOL3122	124	CCOL3244	130	CCOL3226	136
CCOL3232	119	CCOL3223	124	CCOL3225	130	CCOL3224	137
CCOL3223	119	CCOL3260	125	CCOL3226	130	CCOL3123	137
CCOL3230	120	CCOL3221	125	CCOL3224	131	CCOL3226	137
CCOL3231	120	CCOL3132	125	CCOL3233	131	CCOL3234	138
CCOL3232	120	CCOL3223	125	CCOL3226	131	CCOL3123	138
CCOL3240	121	CCOL3270	126	CCOL3234	132	CCOL3226	138
CCOL3241	121	CCOL3231	126	CCOL3233	132	CCOL3244	139
CCOL3232	121	CCOL3132	126	CCOL3226	132	CCOL3123	139
CCOL3223	121	CCOL3223	126	CCOL3244	133	CCOL3226	139

COLUMNS Ø 30

CCOL3251	142	CCOL3622	148	CCOL3326	154	CCOL3334	161
CCOL3322	142	CCOL3323	148	CCOL3334	155	CCOL3633	161
CCOL3323	142	CCOL3331	149	CCOL3325	155	CCOL3326	161
CCOL3331	143	CCOL3622	149	CCOL3326	155	CCOL3326	162
CCOL3322	143	CCOL3323	149	CCOL3326	156	CCOL3633	162
CCOL3323	143	CCOL3323	150	CCOL3325	156	CCOL3326	162
CCOL3323	144	CCOL3622	150	CCOL3326	156	CCOL3354	163
CCOL3322	144	CCOL3323	150	CCOL3354	157	CCOL3623	163
CCOL3323	144	CCOL3331	151	CCOL3325	157	CCOL3326	163
CCOL3351	145	CCOL3632	151	CCOL3326	157	CCOL3334	164
CCOL3332	145	CCOL3323	151	CCOL3334	158	CCOL3623	164
CCOL3323	145	CCOL3331	152	CCOL3333	158	CCOL3326	164
CCOL3331	146	CCOL3632	152	CCOL3326	158	CCOL3326	165
CCOL3332	146	CCOL3323	152	CCOL3326	159	CCOL3623	165
CCOL3323	146	CCOL3323	153	CCOL3333	159	CCOL3326	165
CCOL3332	147	CCOL3632	153	CCOL3326	159		
CCOL3323	147	CCOL3323	153	CCOL3354	160		
CCOL3323	147	CCOL3354	154	CCOL3633	160		
CCOL3351	148	CCOL3325	154	CCOL3326	160		

SKIRTING BOARDS

NF75	234	NF108	235	NF130	237	NW70	238
NF85	234	NF110	236	NF140	237	NW75	239
NF100	235	NF125	236	NW65	238	NW148	239

PROFILSTYL

SKIRTING & CORNER PROFILES

PP23BN	254	PA28BN2	256	PB55BN	258	PB75BN	260
PP22BN2	255	PAB30BN2	257	PB68BN	259	PB110BN	261

WOODSTYL

ANCIENT RUSTIC BEAMS

WT6BN	344	WT21	346	WTC106	350	WTX211	352
WT11BN	344	WT23	346	WTC111	350	WTX226	352
WT13BN	345	WT28	347	WTC126	351	WTFG	353
WT15BN	345	WT30	347	WTX206	351	WTL28NC	353

MODERN BEAMS

WTM12BN	360	WTCMP12BN	362	WTFMP12	364	WTAM69BN	366
WTM16BN	360	WTCMM16BN	362	WTFMM16	364		
WTM22BN	361	WTCMG22BN	363	WTFMG22	365		
WTM10BN	361	WTCMP10BN	363	WTLM26BN	366		

ASSEMBLING INSTRUCTIONS

INSTRUCTION	368	GLUE	372	CEILING CENTRES	380	WOODSTYL	384
MITRE BOX	370	CORNICES	374	BRICKSTYL	380		









CLASSICSTYL



LE CORNICI
IN POLIURETANO



POLYURETHANE
MOULDINGS



ZIERPROFILE
AUS POLYURETHAN



CORNICHES
EN POLYURÉTHANE



MOLDURAS DECORATIVAS
EN POLIURETANO



SANCAS
EM POLIURETANO



SIERPROFIELEN
UIT POLYURETHAAN



KOPNIZES
ΠΟΛΥΟΥΡΕΘΑΝΗΣ



POLYURETAN
LISTER



STUKKATURLISTER
I POLYURETHAN



STUKLISTER
I POLYURETHAN



POLYURETAANILISTAT



OKRASNE PROFILE
IZ POLIURETAN



POLYURITAN
DÍSZLÉCEK



POLIURETAN
PROFILI



ПЛИНТУС
ПОЛІУРЕТАНОВИЙ



ПЛИНТУСА ИЗ
ПОЛИУРЕТАНА



ПОЛИУРИТАНОВИ
ПРОФИЛИ



GZYMSY Z
POLIURETANU



الكرانيش البولوي يوريشين



POLIURETANOVÉ
LIŠTY



ポリウレタン製飾り縁



CORNISE DIN
POLIURETAN

Eleganza e tradizione per questa linea di cornici, colonne, decorazioni, lesene e tutte le altre finiture dell'arte classica, perfette per ambienti dalle atmosfere d'altri tempi.

Elegance and tradition blend in this line of mouldings, columns, decorations, pilasters and other finishing elements typical of classical art, and perfect for old fashioned environments.

Eleganz und Tradition für diese Auswahl an Leisten, Säulen, Dekorationen, Lisenen und anderen Ausführungen der klassischen Kunst, perfekt für ein Ambiente im klassischen Stil aus alten Zeiten.

Эта серия карнизов, колонн, украшений, пилястр и других отелочных элементов в классическом стиле отличается элегантностью и приверженностью традициям. Она идеально подходит для создания атмосферы иных времен.

CEILING CORNICES	20 - 41
COVE LIGHTING	42 - 49
DADO RAILS AND CEILING BORDERS	51 - 59
CORNER BOLOCKS	61 - 63
CEILING CENTERS	65 - 73
DECORATIVE ELEMENTS	75 - 79
WALL LIGHTING	81 - 85
PILASTERS	87 - 93
LIBRARY DECORATIONS	95 - 97
DOOR SURROUNDS	99 - 111
COLUMNS Ø 22,5	113 - 139
COLUMNS Ø 30	140 - 165



The image features a solid, vibrant red background. Three decorative ceiling cornice profiles are shown in a lighter shade of red, creating a subtle, embossed effect. One profile runs diagonally from the top left towards the center. Another profile runs diagonally from the bottom left towards the center. The third profile, located at the bottom right, is highly detailed with intricate floral and scrollwork carvings. The text 'CEILING CORNICES' is centered in the middle of the image in a clean, white, sans-serif font.

CEILING CORNICES

C3230



↕ 3 cm

↔ 3 cm

C3015



↕ 4,2 cm

↔ 4 cm

C3322



↕ 5,5 cm

↔ 4,5 cm

C3128



↕ 5,7 cm

↔ 5,7 cm

C3018



↕ 6 cm

↔ 4,5 cm

C3008



↕ 6,8 cm

↔ 4 cm

C3016

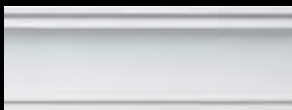

↕ 7 cm

↔ 5,3 cm

C3009



↕ 7,2 cm

↔ 4 cm

C3017



↕ 7,5 cm

↔ 11,5 cm

C3019



Height 8 cm

Width 8,5 cm

C3203



Height 8 cm

Width 5 cm

C3002



Height 8,5 cm

Width 8,5 cm

C3033



Height 8,5 cm

Width 9,5 cm

C3104



Height 10 cm

Width 10 cm

C3044



Height 12 cm

Width 7 cm

C3022



Height 12,5 cm

Width 11 cm

C3004



Height 13 cm

Width 12 cm

C3006



Height 12,5 cm

Width 12,5 cm

C3005



↕ 13 cm

↔ 12,5 cm

C3901



↕ 15 cm

↔ 12,5 cm

C3332

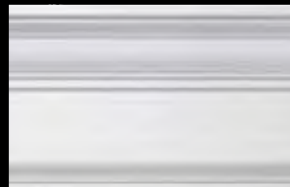

↕ 23 cm

↔ 11,5 cm



CEILING CORNICE C3002

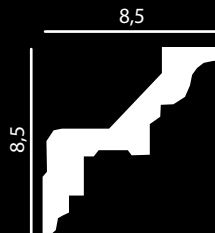

length 200 cm

CEILING CORNICE C3004

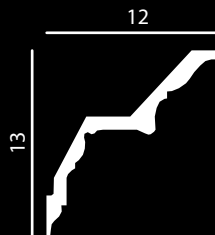

length 200 cm

CEILING CORNICE C3005

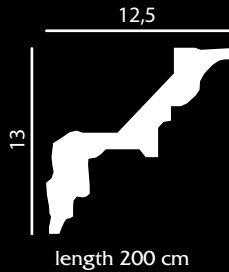

CEILING CORNICE C3006

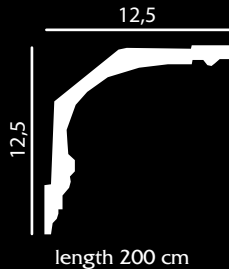

CEILING CORNICE C3008

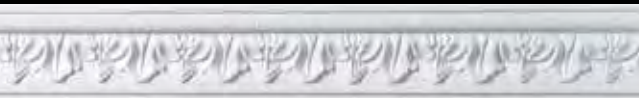

length 200 cm

CEILING CORNICE C3009



length 200 cm

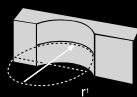

150

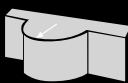

150

Minimal radius of the flexible moulding C3009 BFX

CEILING CORNICE C3015

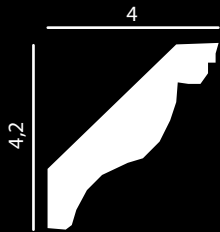

length 200 cm

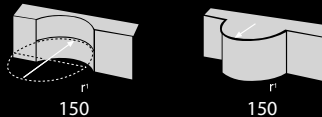

Minimal radius of the flexible moulding C3015 BFX

CEILING CORNICE C3016



length 200 cm

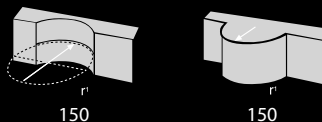
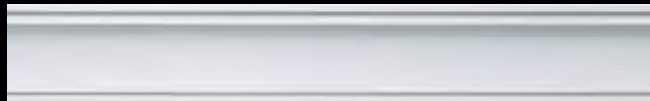

Minimal radius of the flexible moulding C3016 BFX

CEILING CORNICE C3017

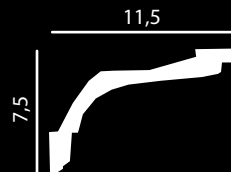
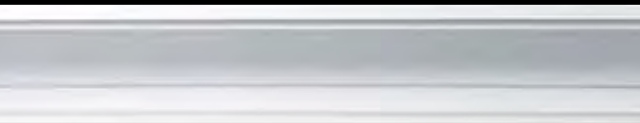

length 200 cm

CEILING CORNICE C3018

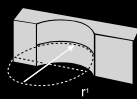

150

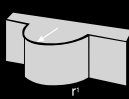

150

Minimal radius of the flexible moulding C3018 BFX



length 200 cm

CEILING CORNICE C3019

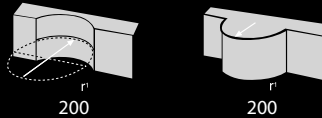

Minimal radius of the flexible moulding C3019 BFX

CEILING CORNICE C3022

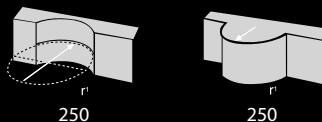
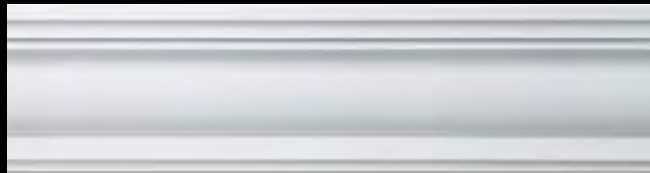
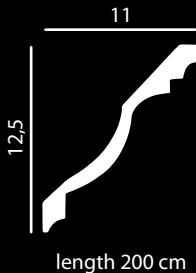

Minimal radius of the flexible moulding C3022 BFX





CEILING CORNICE C3033

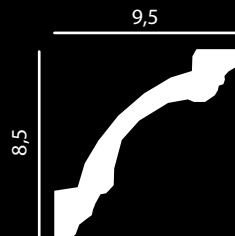

length 200 cm

CEILING CORNICE C3044



length 200 cm

CEILING CORNICE C3104

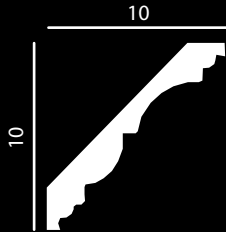

length 200 cm

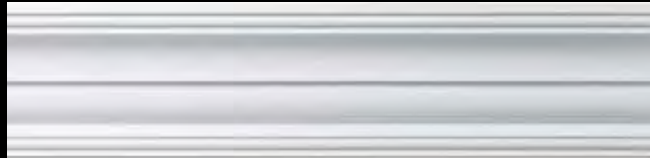

CEILING CORNICE C3128

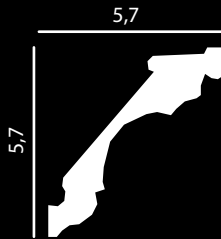

length 200 cm

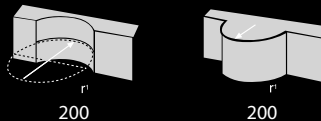

Minimal radius of the flexible moulding C3128 BFX

CEILING CORNICE C3203

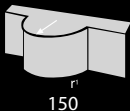
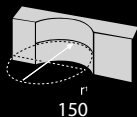

Minimal radius of the flexible moulding C3023 BFX



length 200 cm

CEILING CORNICE C3230

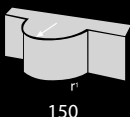
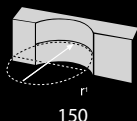

Minimal radius of the flexible moulding C3010 BFX

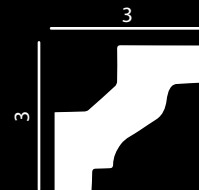

length 200 cm

CEILING CORNICE C3322

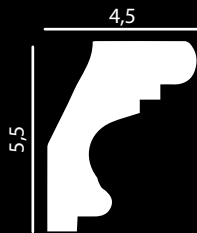

length 200 cm

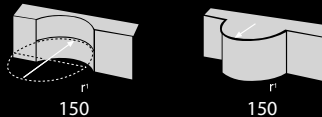

Minimal radius of the flexible moulding C3322 BFX

CEILING CORNICE C3332

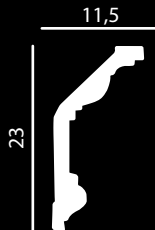

length 200 cm

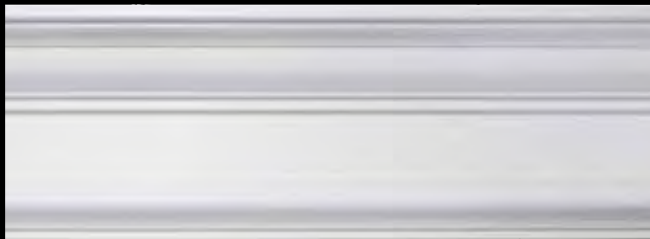

CEILING CORNICE C3901









The background features three white, L-shaped cove lighting profiles. One is positioned in the upper left, another in the middle right, and a third in the lower right. They are set against a solid dark red background. The text 'COVE LIGHTING' is centered in the middle of the image.

COVE LIGHTING

C3215



↕ 10 cm

↔ 7,5 cm

C3225



↕ 10 cm

↔ 10 cm

C3216

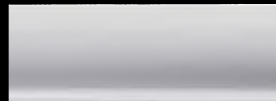

↕ 15 cm

↔ 10 cm

C3226



↕ 15 cm

↔ 15 cm

C3217



↕ 20 cm

↔ 15 cm

C3227



↕ 20 cm

↔ 20 cm

C3228

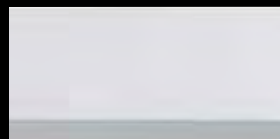

↕ 20 cm

↔ 25 cm

C3218

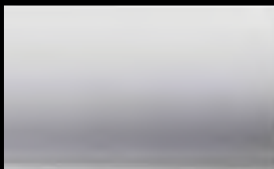

↕ 25 cm

↔ 20 cm

LIGHTING COVING C3215

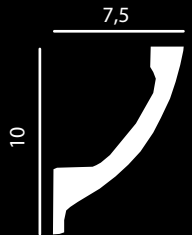

length 200 cm



LIGHTING COVING C3216



length 200 cm



LIGHTING COVING C3217



length 200 cm

LIGHTING COVING C3218

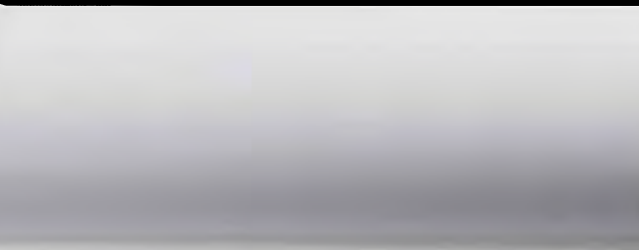

length 200 cm

LIGHTING COVING C3225

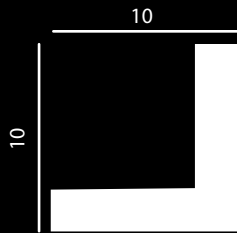

length 200 cm



LIGHTING COVING C3226

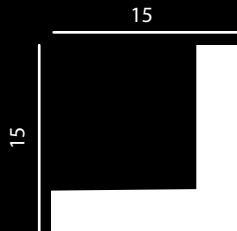

length 200 cm

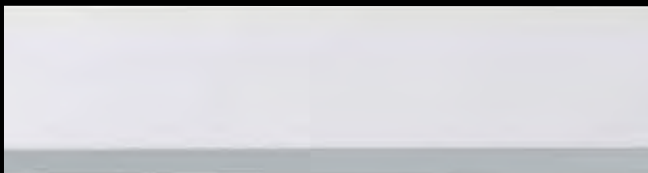

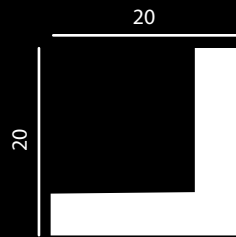
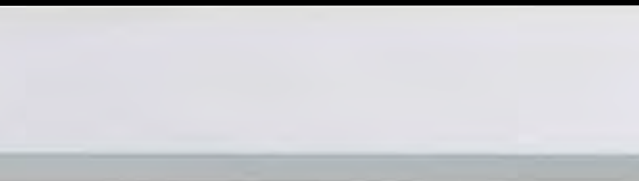
LIGHTING COVING **C3227**

length 200 cm

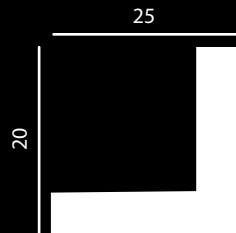
LIGHTING COVING **C3228**

length 200 cm



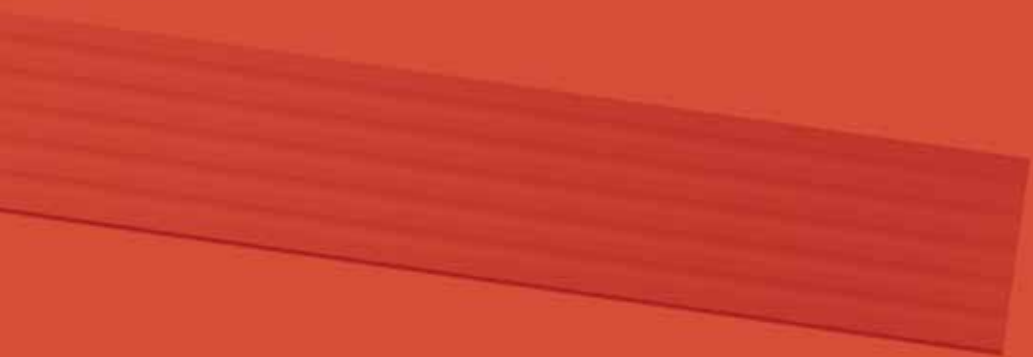

The image features a solid reddish-orange background with several pieces of decorative woodwork. At the top, there is a long, narrow strip with a repeating pattern of stylized floral or leaf motifs. Below it, a larger, wider piece of woodwork with intricate carvings of scrolls and leaves is visible. In the bottom left, a smaller, rectangular piece with a geometric, grid-like pattern is shown. At the bottom, another long strip with a repeating pattern of small, rounded, shell-like or floral motifs is visible. The text 'DADO RAILS AND CEILING BORDERS' is centered in white, bold, sans-serif capital letters.

DADO RAILS AND CEILING BORDERS

C3010



↕ 4,2 cm

↔ 1,8 cm

C3209



↕ 4,3 cm

↔ 2 cm

C3120



↕ 5,2 cm

↔ 2,5 cm

C3060

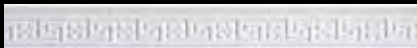

↕ 7,2 cm

↔ 2,2 cm

C3040



↕ 8 cm

↔ 3 cm

C3430



↕ 8,2 cm

↔ 2,7 cm

CP3510



◆ 9,5 cm

◀ 3,3 cm

C3001

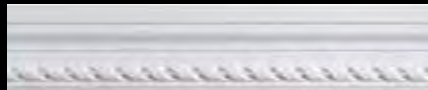

◆ 10,5 cm

◀ 3,5 cm

CL3214



◆ 11 cm

◀ 2 cm

C3012



◆ 12,5 cm

◀ 1,6 cm

CL3204



◆ 13,5 cm

◀ 2 cm

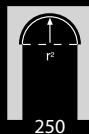
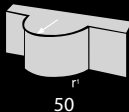
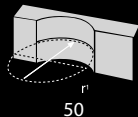
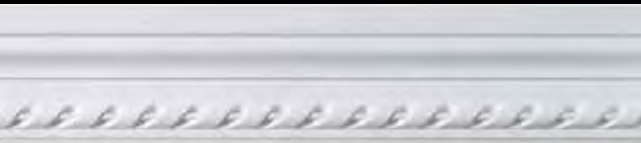

Minimal radius of the flexible moulding C3001 BFX

DADO RAIL C3001



length 200 cm

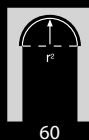
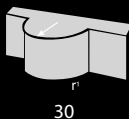
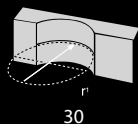

Minimal radius of the flexible moulding C3010 BFX

DADO RAIL C3010

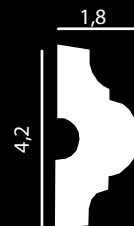

length 200 cm

DADO RAIL C3012



length 200 cm

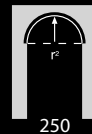
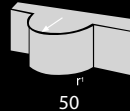
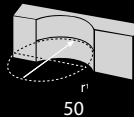

Minimal radius of the flexible moulding C3012 BFX

DADO RAIL C3040



length 200 cm

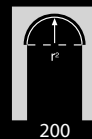
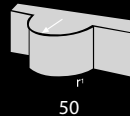
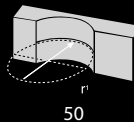

Minimal radius of the flexible moulding C3040 BFX

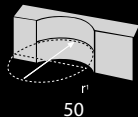

50

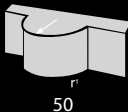

50

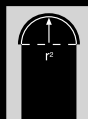

200

Minimal radius of the flexible moulding C3060 BFX

DADO RAIL C3060



length 200 cm

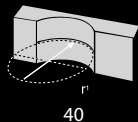

40

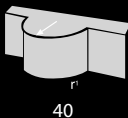

40

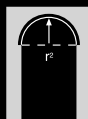

100

Minimal radius of the flexible moulding C3120 BFX

DADO RAIL C3120



length 200 cm

DADO RAIL C3209



length 200 cm

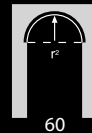
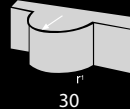
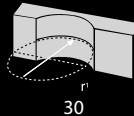

Minimal radius of the flexible moulding C3209 BFX

DADO RAIL C3430



length 200 cm

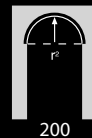
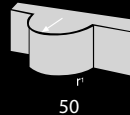
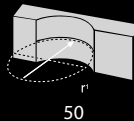

Minimal radius of the flexible moulding C3430 BFX

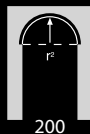
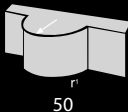
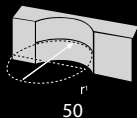
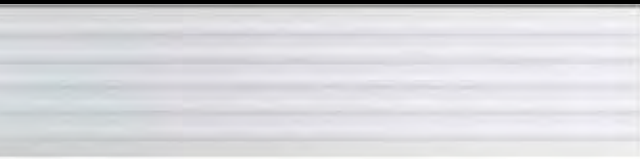

Minimal radius of the flexible moulding C3204 BFX

DADO RAIL CL3204



length 200 cm

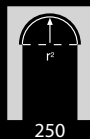
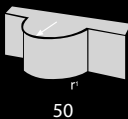
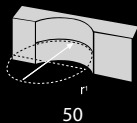

Minimal radius of the flexible moulding C3214 BFX

DADO RAIL CL3214



length 200 cm

DADO RAIL CP3510



length 200 cm

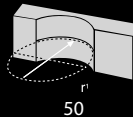

50

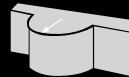

50

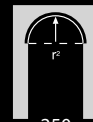

250

Minimal radius of the flexible moulding C3510 BFX



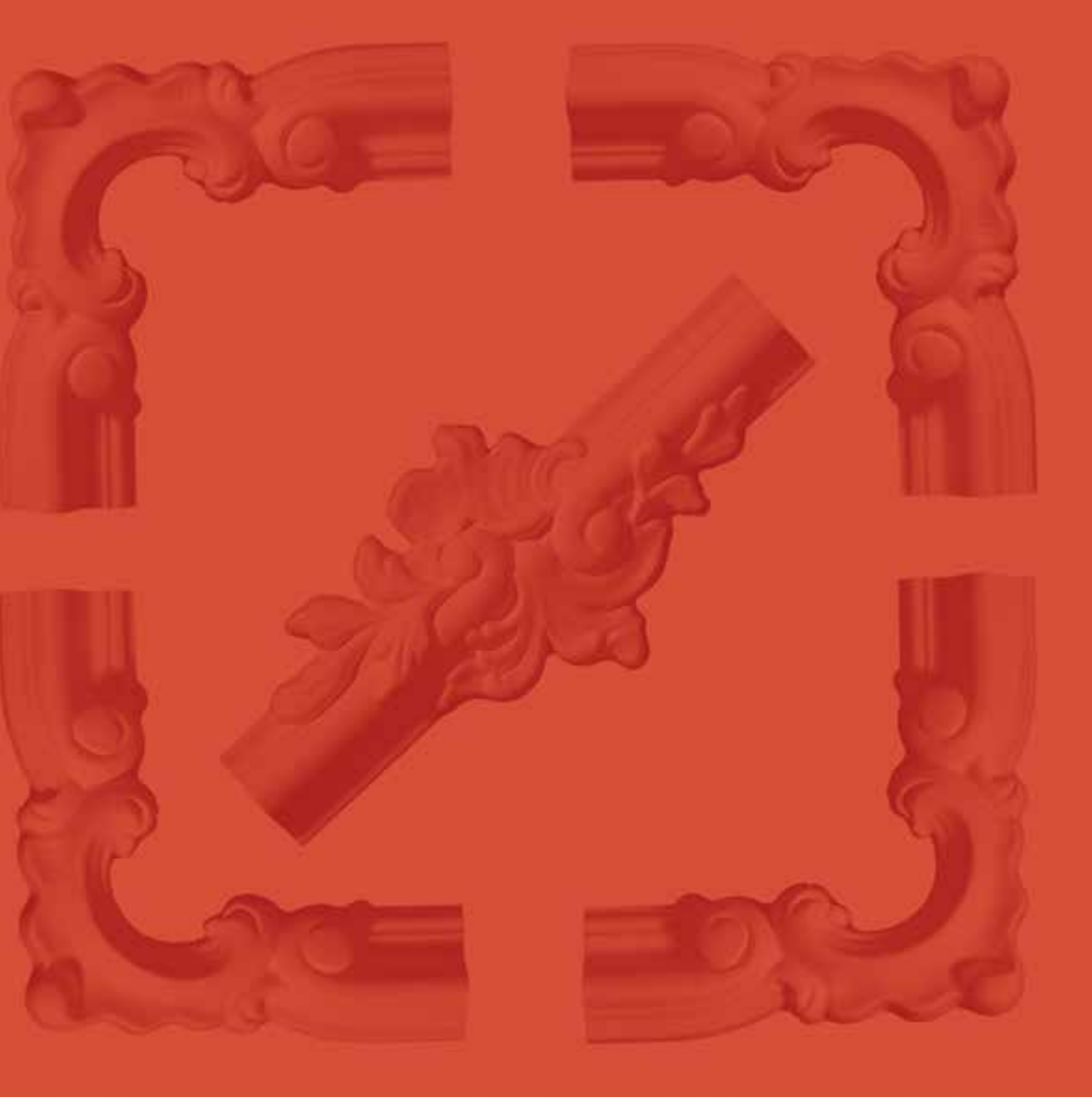

The background features a repeating pattern of decorative corner blocks. Each block is a quarter of a larger, ornate frame with rounded corners and intricate carvings. The blocks are arranged in a grid, with the central area being empty. The entire image has a uniform reddish-orange color scheme.

CORNER BLOCKS

CORNER CA3010



W 15 x H 15 x R 8

for C3010

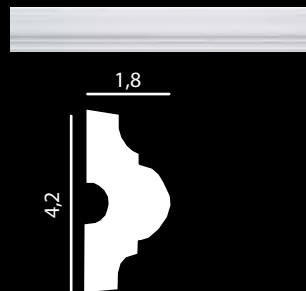

CORNER CA3120



W 25 x H 25 x R 14

for C3120

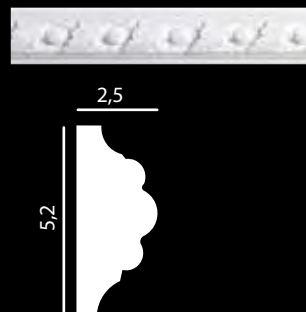

for C3209



CORNER CA3209



W 14,5 x H 14,5

for C3010

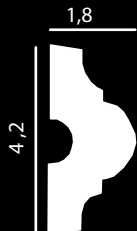

CORNER CF3010



W 24 x H 11





CEILING CENTERS

CR3321



Ø 16,5

D 3,5

CR3314



Ø 33,5

D 6

CR3305



Ø 40

D 6

CR3307



Ø 43,5

D 5

CR3325



43,5 x 30,5

D 4,5

CR3323



Ø 46

D 6

CR3316



Ø 48

D 4,5

CR3308



Ø 49,5

D 6,5

CR3315



Ø 57,5

D 3

CR3311



Ø 66,5

D 4,5

CR3320



Ø 76

D 6,5

CR3324



Ø 77

D 5

CR3322



77x53

D 4,5

CR3312



Ø 83

D 7

CR3364



Ø 96

D 7,5

CEILING CENTER CR3305



Ø 40

D 6

CEILING CENTER CR3307



Ø 43,5

D 5

CEILING CENTER CR3308



Ø 49,5

D 6,5

CEILING CENTER CR3311



Ø 66,5

D 4,5

CEILING CENTER CR3312



Ø 83

D 7

CEILING CENTER CR3314



Ø 33,5

D 6

CEILING CENTER CR3315



Ø 57,5

D 3

CEILING CENTER CR3316



Ø 48

D 4,5

CEILING CENTER CR3320



Ø 76

D 6,5

CEILING CENTER CR3321



Ø 16,5

D 3,5

CEILING CENTER CR3322



77x53

D 4,5

CEILING CENTER CR3323



Ø 46

D 6

CEILING CENTER CR3324



Ø 77

D 5

CEILING CENTER CR3325



30,5x43,5

D 4,5

CEILING CENTER CR3364



Ø 96

D 7,5







The background is a solid, vibrant red color. Overlaid on this background are several large, stylized floral or leaf-like decorative elements in a lighter shade of red. These elements are positioned in the corners and center, creating a sense of depth and texture. The central text is white and stands out prominently against the red background.

DECORATIVE ELEMENTS

CF3621



↕ 8 cm ↔ 14 cm

CF3654



↕ 13 cm ↔ 12,5 cm

CM3823



↕ 14,5 cm ↔ 10,5 cm

CF3623



↕ 16 cm ↔ 11,7 cm

CF3652



↕ 18 cm ↔ 24 cm

CM3403



↕ 19 cm ↔ 19 cm

CM3962



↕ 25,5 cm ↔ 17,5 cm

CF3624



↕ 26,5 cm ↔ 16 cm

CN3002



↕ 49 cm ↔ 27,8 cm

CN3001



↕ 77 cm ↔ 45,5 cm

FRIEZE CF3621



W 14xH 8xD 2

FRIEZE CF3623



W 11,7xH 16xD 2

FRIEZE CF3624



W 16xH 26,5xD 4

FRIEZE CF3652



W 24xH 18xD 2

FRIEZE CF3654



W 12,5 x H 13 x D 1

WALL CORBEL CM3403



W 19 x H 19 x D 10

WALL CORBEL CM3823



W 10,5 x H 14,5 x D 7

WALL CORBEL CM3962



W 17,5 x H 25,5 x D 12,5

NICHE CN3001



W 45,5 x H 77 x D 20

NICHE CN3002



W 27,8 x H 49 x D 8

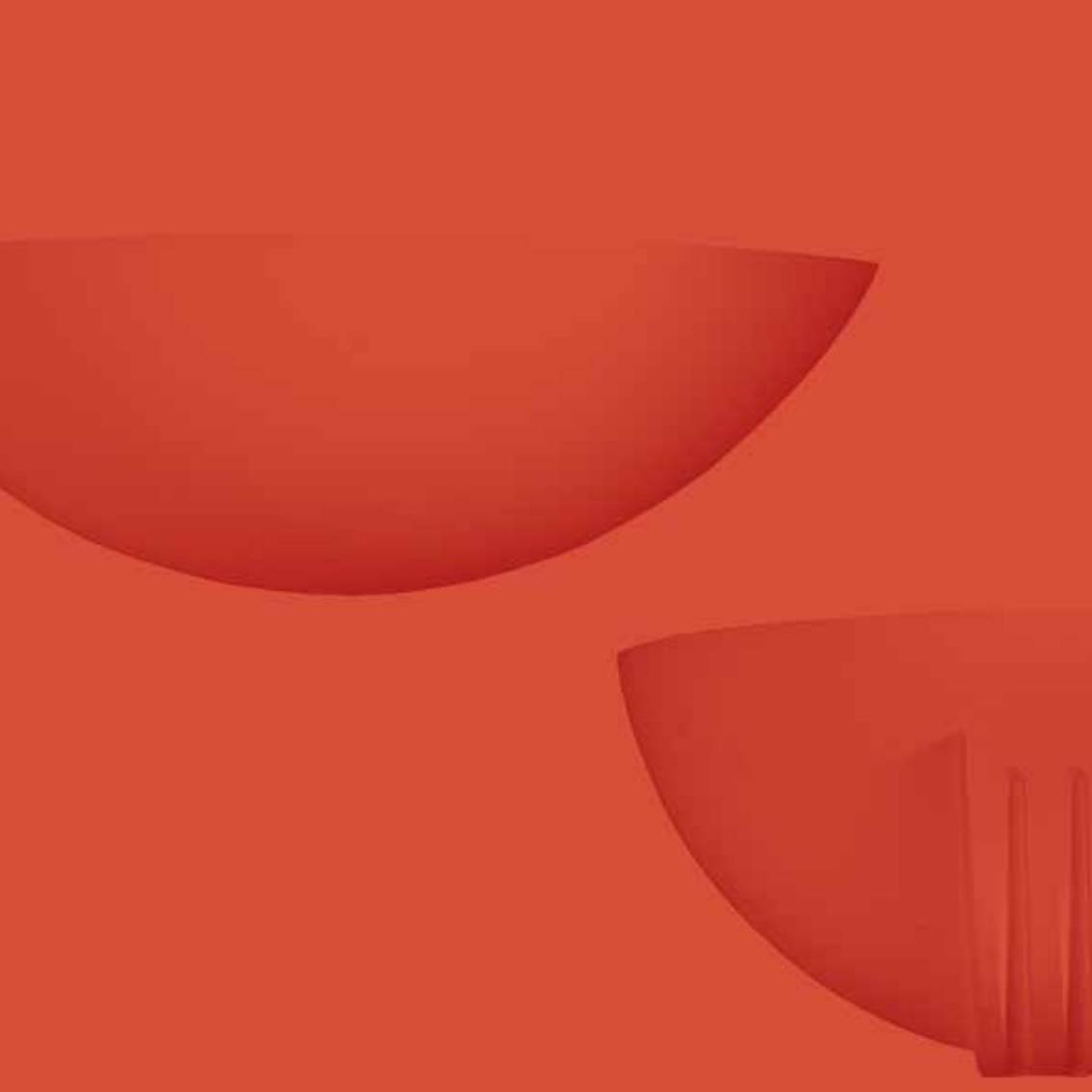



WALL LIGHTING





WALL LIGHT CD3704



W 30 x H 14 x D 12,5

WALL LIGHT CD3705



W 42 x H 12 x D 12

WALL LIGHT CD3709



W 35,5 x H 16,5 x D 14,5

WALL LIGHT CD3713



W 45,5 x H 20,5 x D 20,5





PILASTERS

BIG PILASTER

CL3200

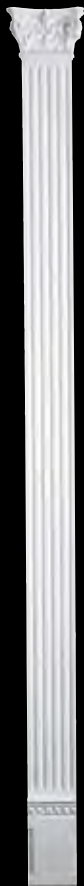

246

BIG
PILASTER
CAPITAL CL3201

W 21,5 x H 13 x D 5,5

BIG
PILASTER
BASE CL3203

W 13,5 x H 26 x D 3

BIG
PILASTER
PILLAR CL3202

W 13,5 x H 206 x D 2

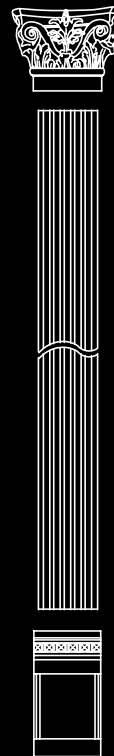

13

206

26

H 245

BIG
PILASTER
PILLAR **CL3202**

BIG
DORIC
CAPITEL **CL3205G**

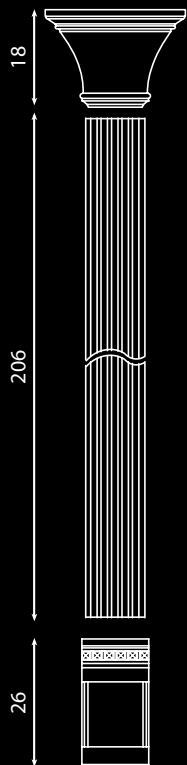

H 249



W 13,5 x H 206 x D 2



W 28,5 x H 18 x D 9,5

BIG
PILASTER
BASE **CL3203**



W 13,5 x H 26 x D 3

IONIC
CAPITAL
CL3206



W 46 x H 18 x D 7,5

BIG
JOINT
CL3206RG



W 25,7 x H 10,3 x D 3,7

BIG
PILASTER
PILLAR CL3202



W 13,5 x H 206 x D 2

BIG
PILASTER
BASE CL3203



W 13,5 x H 26 x D 3

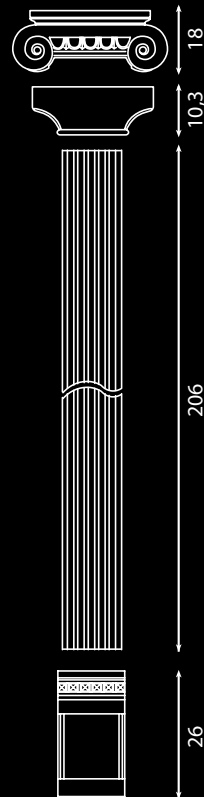

H 254

SMALL
PILASTER
PILLAR **CL3212**

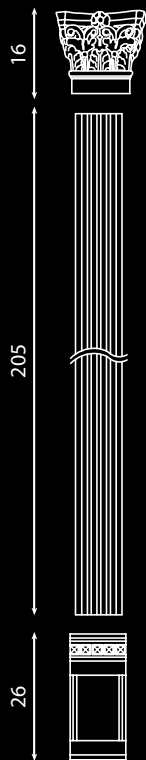

H 247

W 11 x H 205 x D 2

SMALL
PILASTER
CAPITAL **CL3211**



W 17,5 x H 16 x D 4,5

SMALL
PILASTER
BASE **CL3213**



W 11 x H 26 x D 3

SMALL PILASTER
CL3210

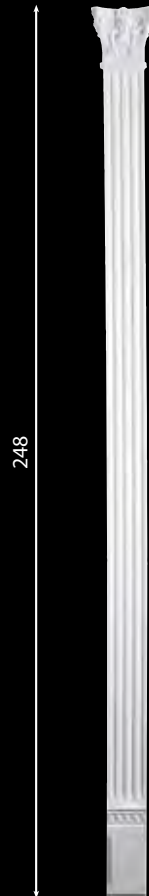

248

SMALL
DORIC CAPITAL
CL3205P



W 28,5 x H 20 x D 9,5

SMALL
PILASTER
BASE
CL3213



W 11 x H 26 x D 3

SMALL
PILASTER
PILLAR CL3212



W 11 x H 205 x D 2

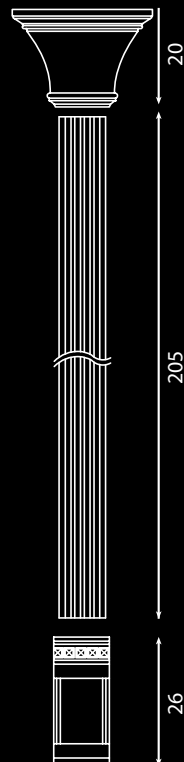

H 251

SMALL
PILASTER
PILLAR **CL3212**

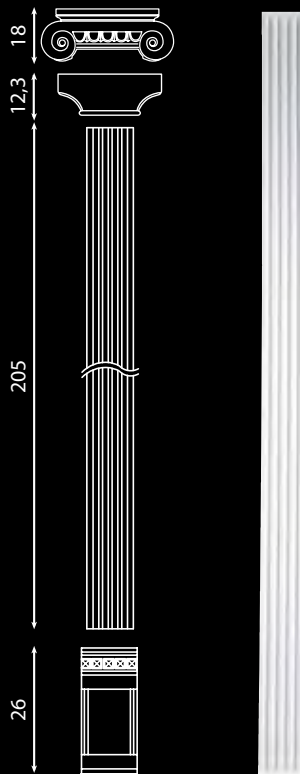

H 256

SMALL
JOINT
CL3206RP



W 25,7 x H 12,3 x D 3,7

IONIC
CAPITAL
CL3206



W 46 x H 18 x D 7,5

SMALL
PILASTER
BASE **CL3213**



W 11 x H 26 x D 3





LIBRARY
DECORATIONS

CB3501S + B3501D

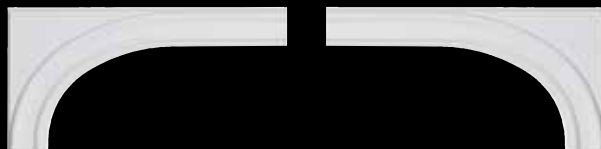

2 x (W 66 x H 34 x D 3,3)

CP3502



W 9 x H 11,5 x D 4,5

CP3586

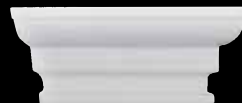

W 12,5 x H 5 x D 4,8

CP3587



W 9,5 x H 25,5 x D 4

CP3585



W 22,5 x H 5 x D 4,8

CP3510



W 9,5 x H 200 x D 3,3







DOOR SURROUNDS



CP3588

CP3501

CP3588



CP3510

CP3510



CP3587

CP3587



DOOR SURROUND CP3501



W 12,5 x H 19,5 x D 3,3

DOOR SURROUND CP3588



W 9,5 x H 9,5 x D 5



200

CP3510



CP3587



W 9,5 x H 25,5 x D 4

DOOR DECORATION CP3511



2 x (W 31 x H 10,8 x D 1)

DOOR DECORATION CP3512



W 43,5 x H 11,5 x D 1,6

DOOR DECORATION CP3514



W 32,5 x H 13,5 x D 1,6

DOOR DECORATION CP3515



W 23,5 x H 13 x D 3

DOOR DECORATION CP3562



W 15,4 x H 11,5 x D 1,6

RAISED DOOR PANEL CP3590

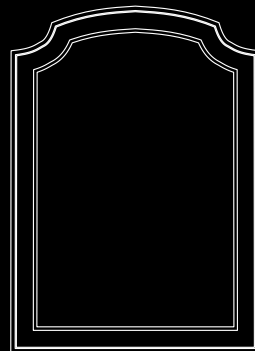

W 55 x H 75,5 x D 1,6

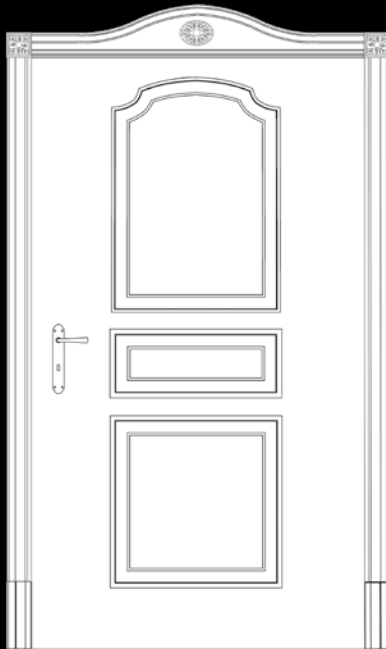

DOOR SURROUND CP3591

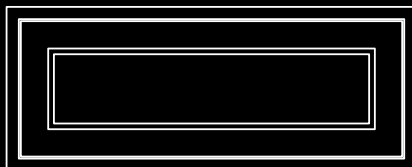
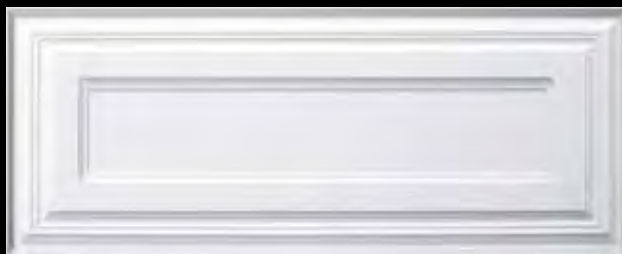

H 22 x W 55 x D 1,6

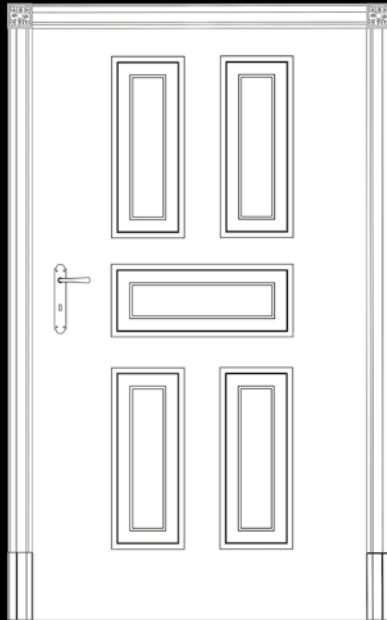

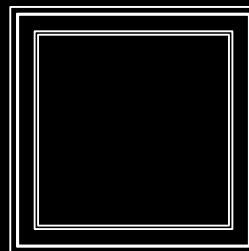

DOOR SURROUND CP3592

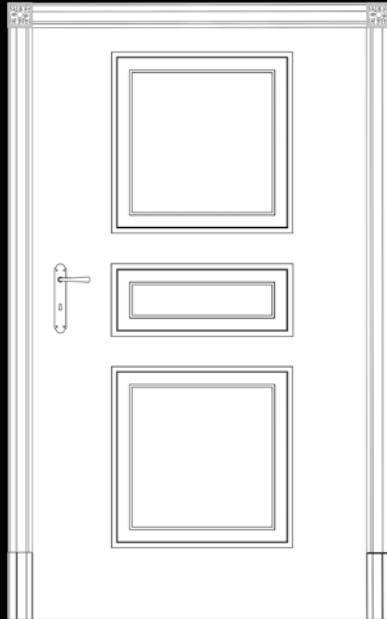

W 55 x H 55 x D 1,6

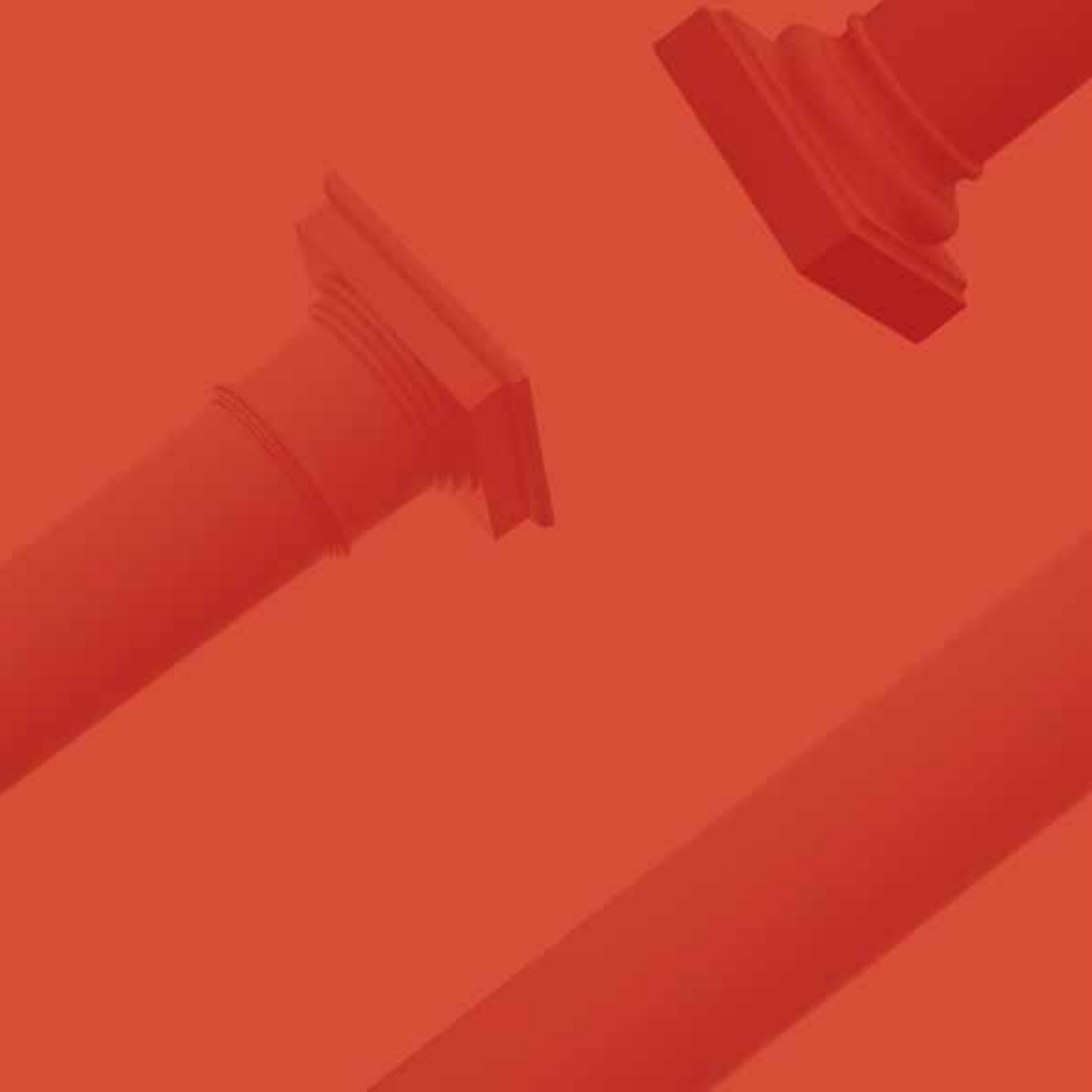



The image features a solid red background with four decorative column capitals arranged in a circular pattern. Each capital is a different style, including classical fluted capitals and more ornate, carved designs. The text is centered in the middle of the composition.

COLUMNS
Ø CM. 22,5





FLUTED
CORINTHIAN
COLUMN
CCOL3220

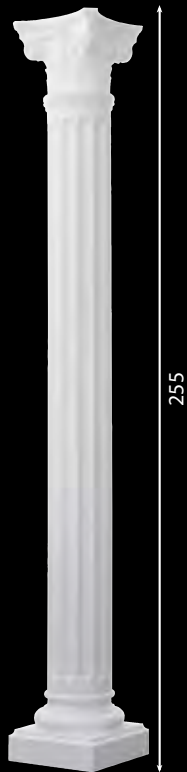

FLUTED CORINTHIAN COLUMN

CORINTHIAN
CAPITAL
CCOL3221



FLUTED
PILLAR
CCOL3222



BASE
CCOL3223

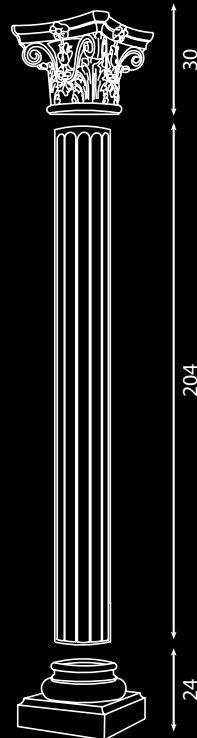
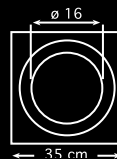

FLUTED IONIC COLUMN

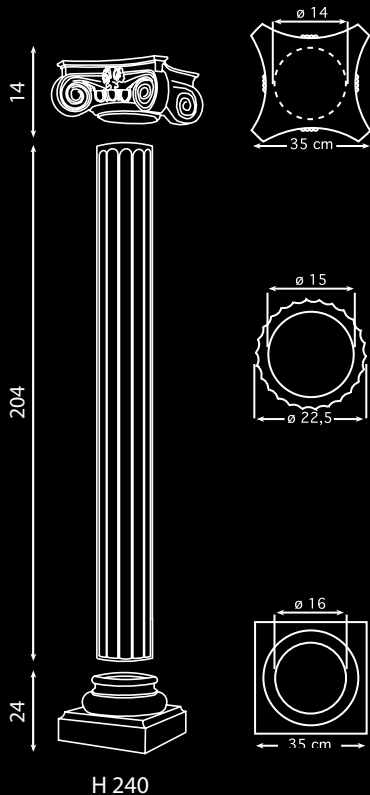
FLUTED
PILLAR
CCOL3222IONIC
CAPITAL
CCOL3231BASE
CCOL3223

FLUTED DORIC COLUMN

DORIC
CAPITAL
CCOL3241



FLUTED
PILLAR
CCOL3222



BASE
CCOL3223

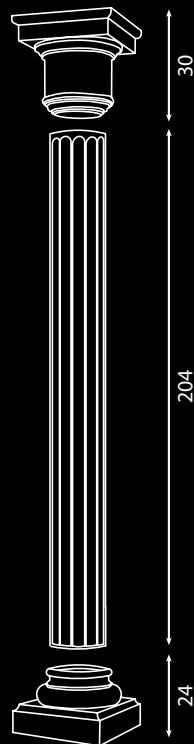
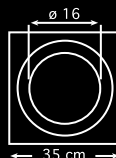

H 255

SMOOTHED CORINTHIAN COLUMN

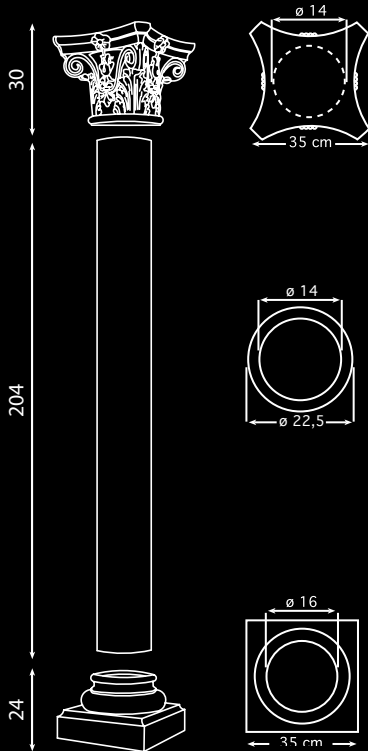

H 255

SMOOTHED
PILLAR
CCOL3232



CORINTHIAN
CAPITAL
CCOL3221



BASE
CCOL3223



SMOOTHED
IONIC
COLUMN
CCOL3230

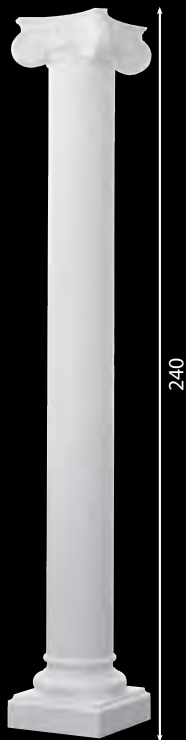

SMOOTHED IONIC COLUMN

IONIC
CAPITAL
CCOL3231



BASE
CCOL3223



SMOOTHED
PILLAR
CCOL3232

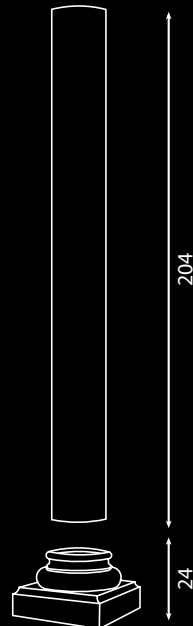
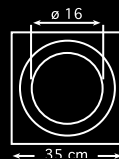

SMOOTHED DORIC COLUMN

SMOOTHED
DORIC
COLUMN
CCOL3240

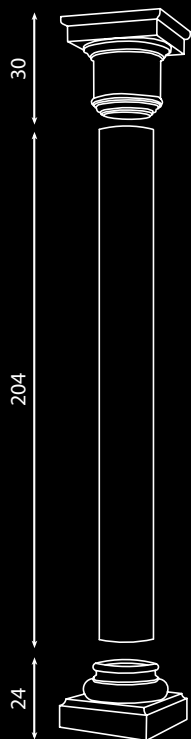

H 255

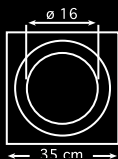

SMOOTHED
PILLAR
CCOL3232



DORIC
CAPITAL
CCOL3241



BASE
CCOL3223

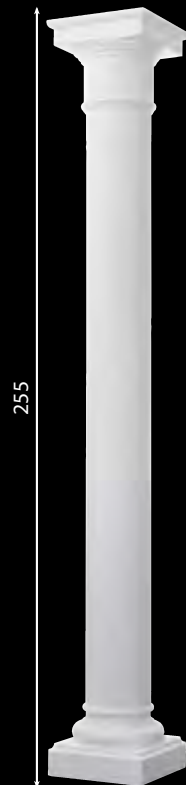

FLUTED CORINTHIAN SMALL COLUMN

CCOL3261



CORINTHIAN
CAPITAL
CCOL3221



FLUTED
SMALL PILLAR
CCOL3122



BASE
CCOL3223

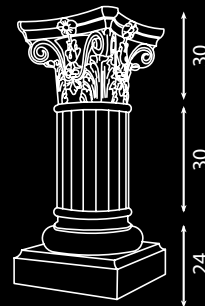
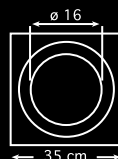
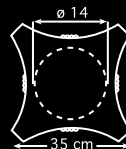

FLUTED IONIC SMALL COLUMN

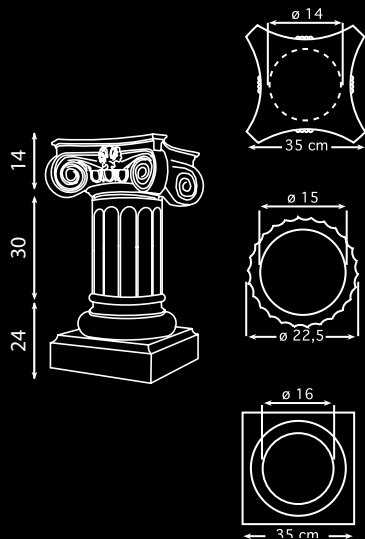

IONIC
CAPITAL
CCOL3231



CCOL3271

FLUTED
SMALL PILLAR
CCOL3322



BASE
CCOL3223



FLUTED DORIC SMALL COLUMN

CCOL3251

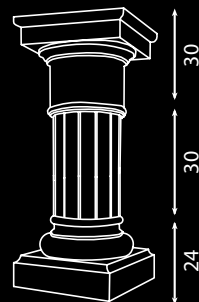
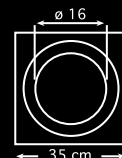
DORIC
CAPITAL
CCOL3241FLUTED
SMALL PILLAR
CCOL3122BASE
CCOL3223

SMOOTHED CORINTHIAN SMALL COLUMN

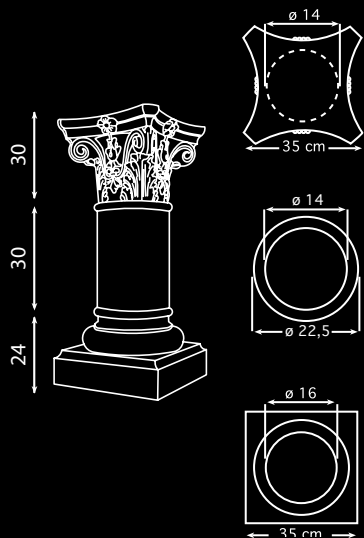
CORINTHIAN
CAPITAL

CCOL3221



CCOL3260

SMOOTHED
SMALL PILLAR

CCOL3132



BASE

CCOL3223



SMOOTHED IONIC SMALL COLUMN

CCOL3270



IONIC
CAPITAL
CCOL3231



SMOOTHED
SMALL PILLAR
CCOL3132



BASE
CCOL3223

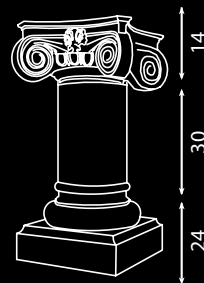
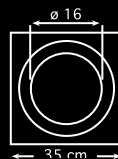

SMOOTHED DORIC SMALL COLUMN

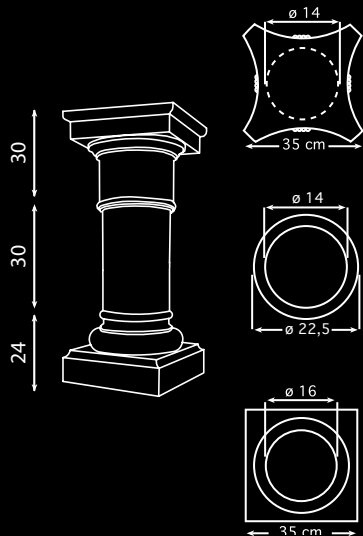

DORIC
CAPITAL
CCOL3241



SMOOTHED
SMALL PILLAR
CCOL3132



BASE
CCOL3223



SMOOTHED
DORIC
SMALL COLUMN
CCOL3250



FLUTED CORINTHIAN HALF COLUMN

CORINTHIAN HALF
CAPITAL
CCOL3224



FLUTED HALF
PILLAR
CCOL3225



HALF BASE
CCOL3226

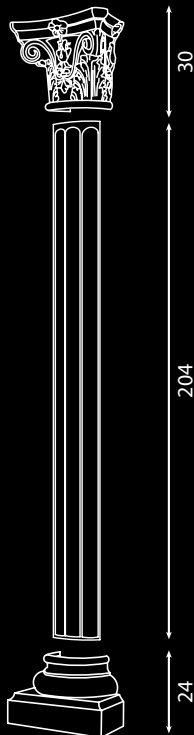
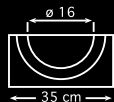
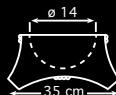

H 255

FLUTED IONIC HALF COLUMN

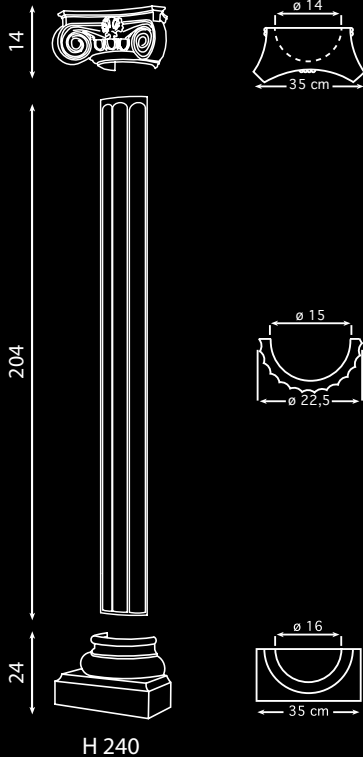

FLUTED HALF
PILLAR
CCOL3225



IONIC HALF
CAPITAL
CCOL3234



HALF BASE
CCOL3226



FLUTED DORIC HALF COLUMN

DORIC HALF
CAPITAL
CCOL3244



FLUTED HALF
PILLAR
CCOL3225



HALF BASE
CCOL3226

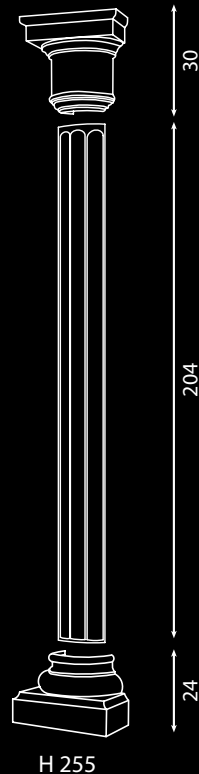
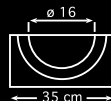
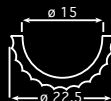
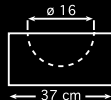

SMOOTHED CORINTHIAN HALF COLUMN

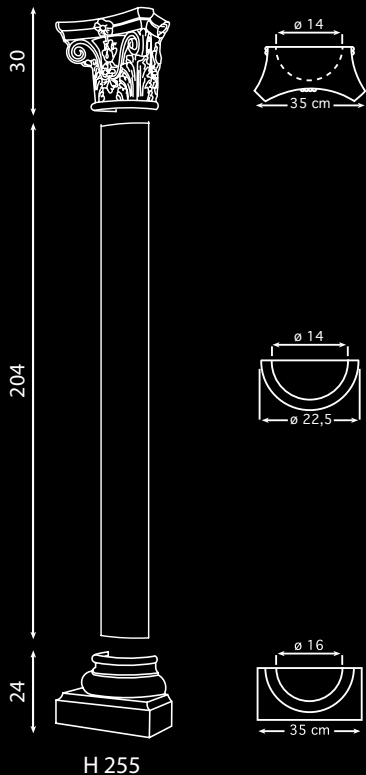

SMOOTHED HALF
PILLAR
CCOL3233

CORINTHIAN HALF
CAPITAL
CCOL3224



HALF BASE
CCOL3226

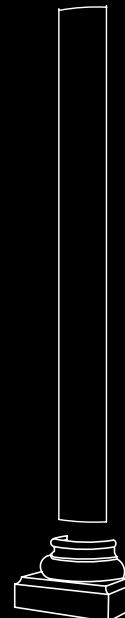
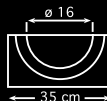
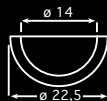

SMOOTHED IONIC HALF COLUMN

IONIC HALF
CAPITAL
CCOL3234SMOOTHED HALF
PILLAR
CCOL3233HALF BASE
CCOL3226

H 255

14

204

24

SMOOTHED DORIC HALF COLUMN

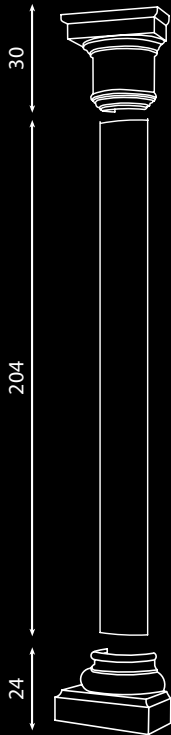

H 255

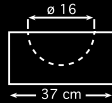

SMOOTHED HALF
PILLAR
CCOL3233

DORIC HALF
CAPITAL
CCOL3244

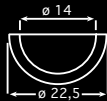

HALF BASE
CCOL3226

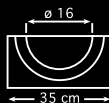

FLUTED CORINTHIAN HALF COLUMN

CORINTHIAN HALF
CAPITAL

CCOL3224



30

FLUTED SMALL
HALF PILLAR

CCOL3133

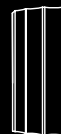
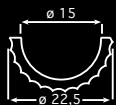

30

HALF BASE

CCOL3226

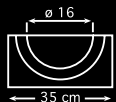

24

H 81

FLUTED IONIC HALF COLUMN

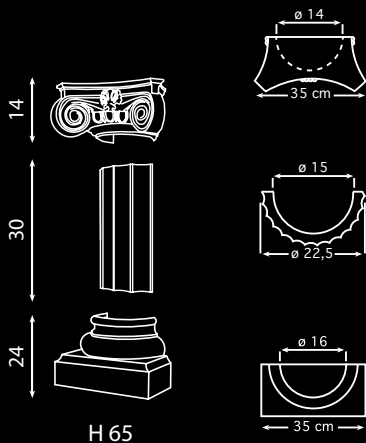

IONIC HALF
CAPITAL
CCOL3234



FLUTED SMALL
HALF PILLAR
CCOL3133



HALF BASE
CCOL3226



FLUTED DORIC SMALL HALF COLUMN

DORIC HALF
CAPITAL

CCOL3244

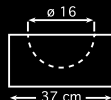
FLUTED SMALL
HALF PILLAR

CCOL3133

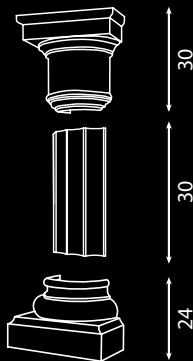
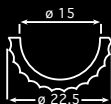

HALF BASE

CCOL3226

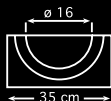

H 81

SMOOTHED CORINTHIAN SMALL HALF COLUMN

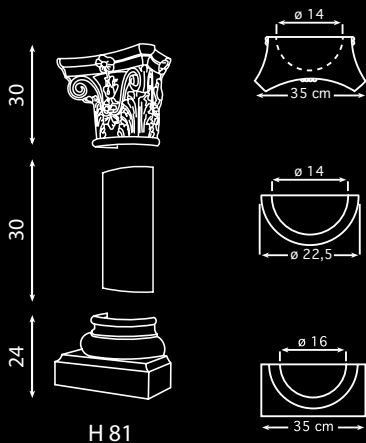
CORINTHIAN HALF
CAPITAL
CCOL3224SMOOTHED SMALL
HALF PILLAR
CCOL3123HALF BASE
CCOL3226

SMOOTHED IONIC SMALL HALF COLUMN

IONIC HALF
CAPITAL
CCOL3234



14



SMOOTHED SMALL
HALF PILLAR
CCOL3123

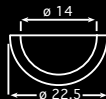

30

HALF BASE
CCOL3226

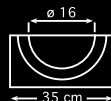

24

H 65

SMOOTHED DORIC SMALL HALF COLUMN

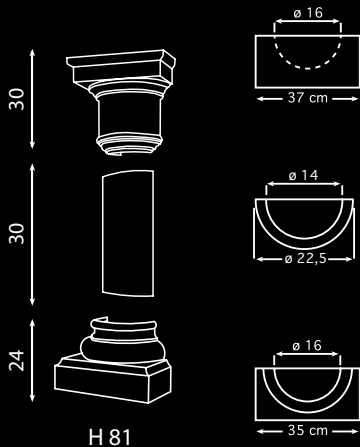
CORINTHIAN HALF
CAPITAL
CCOL3244SMOOTHED SMALL
HALF PILLAR
CCOL3123HALF BASE
CCOL3226

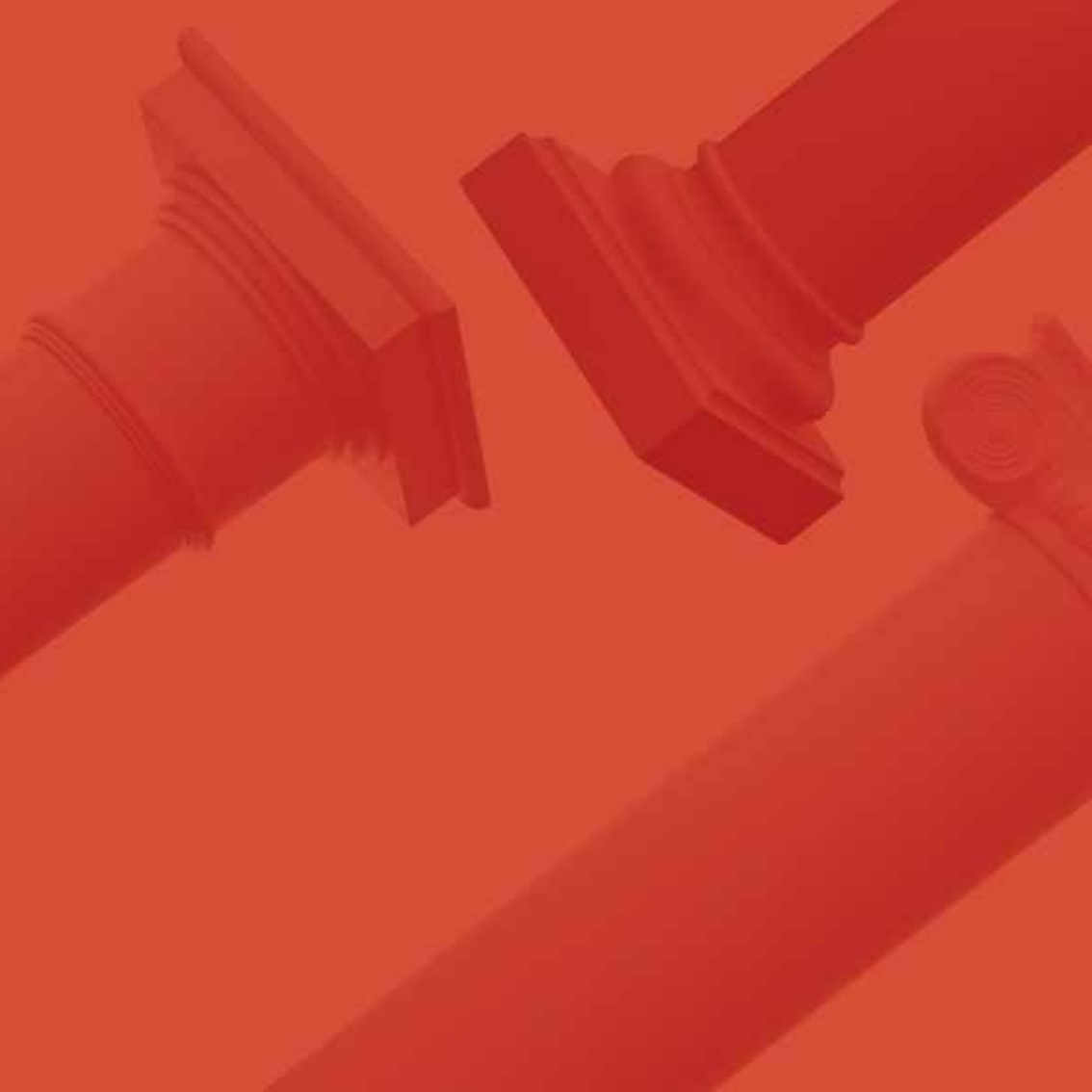

The background of the image is a solid, vibrant red color. Overlaid on this background are several classical columns, likely of the Corinthian or Composite order, shown from a low angle looking up. The columns are semi-transparent, allowing the red background to show through them. They are arranged in a circular pattern, with their capitals and fluted shafts visible. The lighting is soft, highlighting the architectural details of the columns.

COLUMNS
Ø CM. 30

FLUTED HELLENIC COLUMN

HELLENIC
CAPITAL
CCOL3351



FLUTED
PILLAR
CCOL3322



BASE
CCOL3323

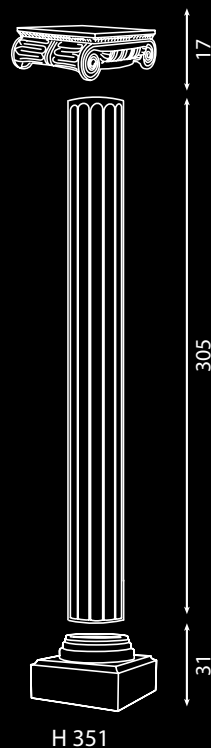
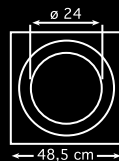
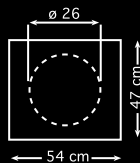

H 351

FLUTED IONIC COLUMN

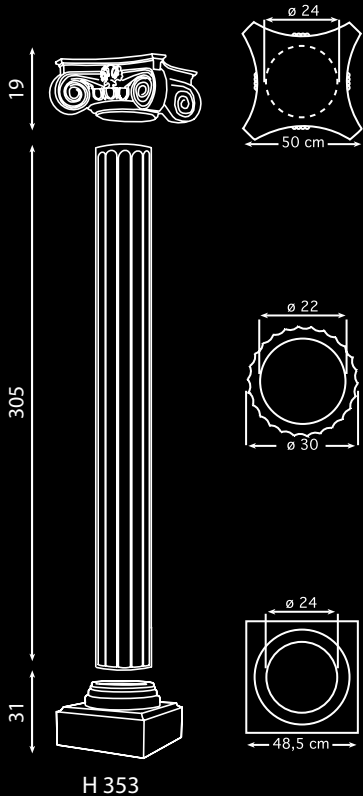

FLUTED
PILLAR
CCOL3322



IONIC
CAPITAL
CCOL3331



BASE
CCOL3323



FLUTED DORIC COLUMN

DORIC
CAPITAL
CCOL3323



FLUTED
PILLAR
CCOL3322



BASE
CCOL3323

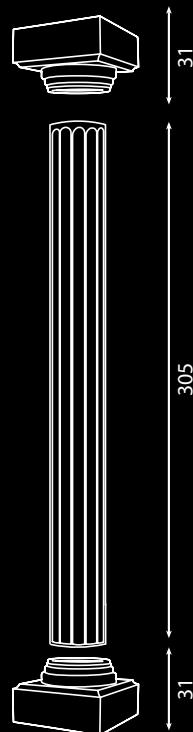
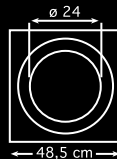
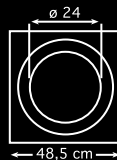

H 365

SMOOTHED HELLENIC COLUMN

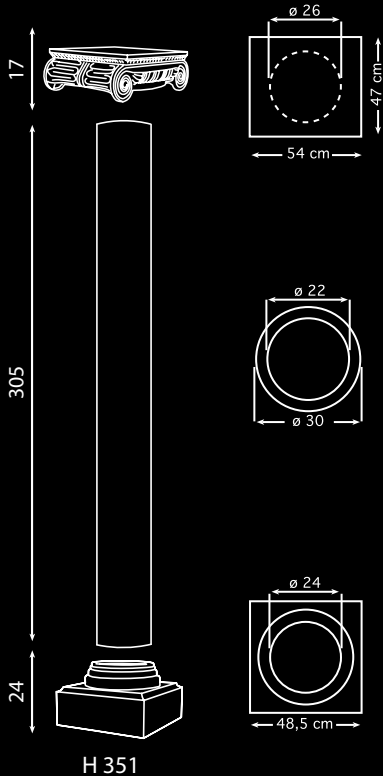
SMOOTHED
PILLAR
CCOL3332HELLENIC
CAPITAL
CCOL3351BASE
CCOL3323

SMOOTHED IONIC COLUMN

IONIC
CAPITAL
CCOL3331



SMOOTHED
PILLAR
CCOL3332



BASE
CCOL3323

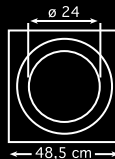

H 353

SMOOTHED DORIC COLUMN

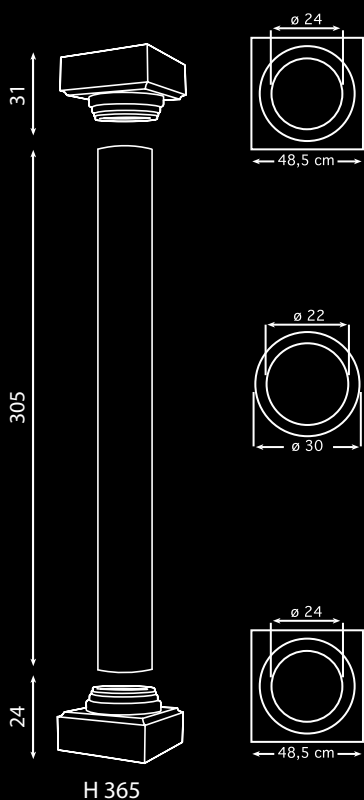

SMOOTHED
PILLAR
CCOL3332



DORIC
CAPITAL
CCOL3323



BASE
CCOL3323



FLUTED HELLENIC SMALL COLUMN

HELLENIC
CAPITAL
CCOL3351

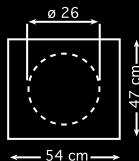

FLUTED
SMALL PILLAR
CCOL3622

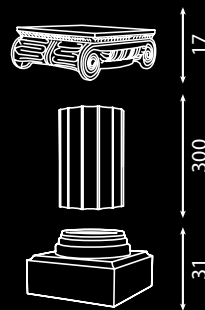

BASE
CCOL3323

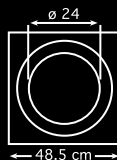

H 76

FLUTED IONIC SMALL COLUMN

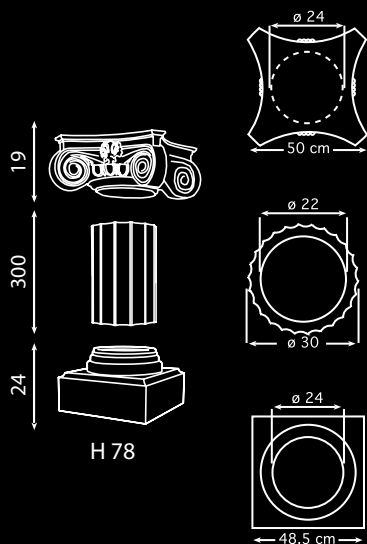

IONIC
CAPITAL
CCOL3331



FLUTED
SMALL PILLAR
CCOL3622



BASE
CCOL3323

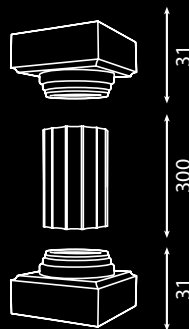
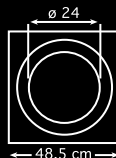

FLUTED DORIC SMALL COLUMN

DORIC
CAPITAL
CCOL3323FLUTED
SMALL PILLAR
CCOL3622BASE
CCOL3323

SMOOTHED HELLENIC SMALL COLUMN

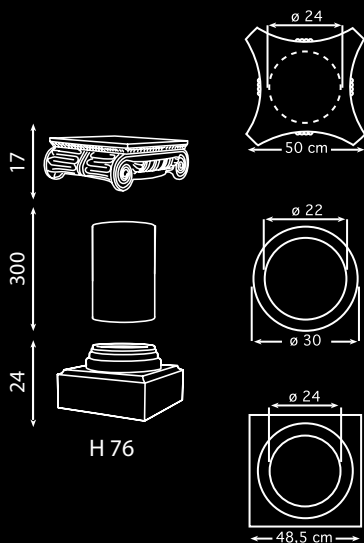
HELLENIC
CAPITAL
CCOL3331SMOOTHED
SMALL PILLAR
CCOL3632BASE
CCOL3323

FLUTED IONIC SMALL COLUMN

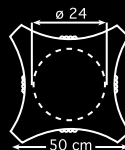
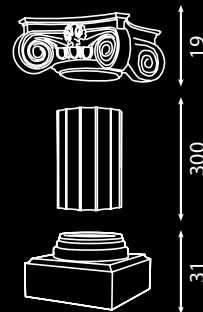
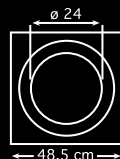
IONIC
CAPITAL
CCOL3331FLUTED
SMALL PILLAR
CCOL3632BASE
CCOL3323

H 78

SMOOTHED DORIC SMALL COLUMN

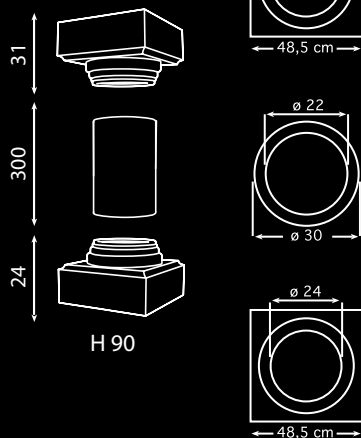

DORIC
CAPITAL
CCOL3323



SMOOTHED
SMALL PILLAR
CCOL3632



BASE
CCOL3323



FLUTED HELLENIC HALF COLUMN

HELLENIC HALF
CAPITAL
CCOL3354



FLUTED HALF
PILLAR
CCOL3325



HALF BASE
CCOL3326

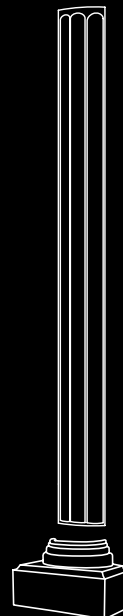
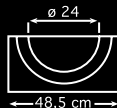
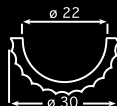
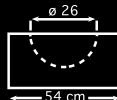

H 351

FLUTED IONIC HALF COLUMN

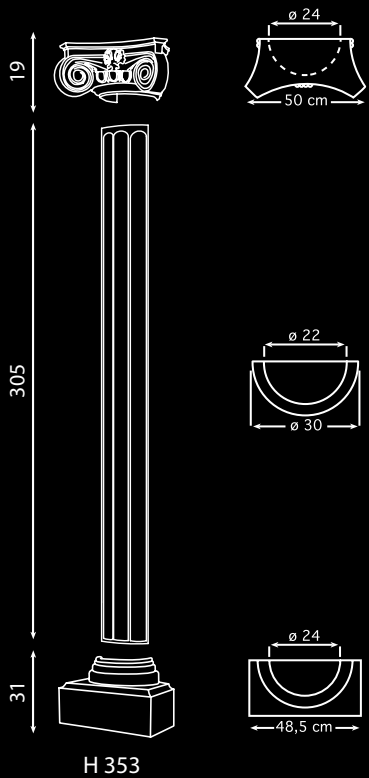

H 353

FLUTED HALF
PILLAR
CCOL3325



IONIC HALF
CAPITAL
CCOL3334



HALF BASE
CCOL3326



FLUTED DORIC HALF COLUMN

DORIC HALF
CAPITAL
CCOL3326



HALF BASE
CCOL3326



FLUTED HALF
PILLAR
CCOL3325

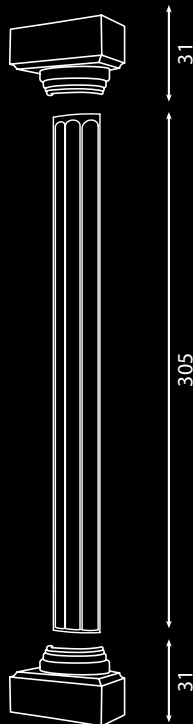
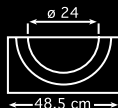
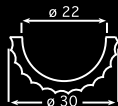
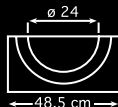

H 365

SMOOTHED HELLENIC HALF COLUMN

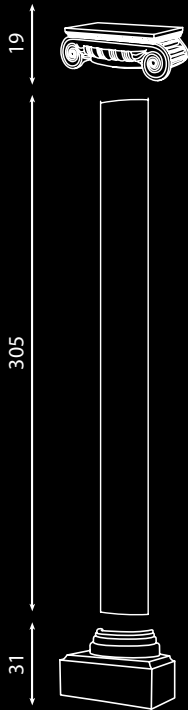

H 351

SMOOTHED HALF
PILLAR
CCOL3325



HELLENIC HALF
CAPITAL
CCOL3354



HALF BASE
CCOL3326



SMOOTHED IONIC HALF COLUMN

IONIC HALF
CAPITAL
CCOL3334



SMOOTHED HALF
PILLAR
CCOL3333



HALF BASE
CCOL3326

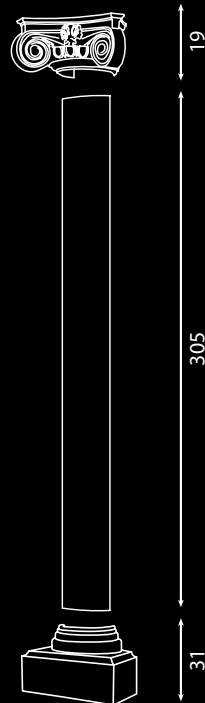
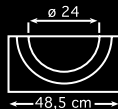
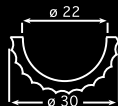
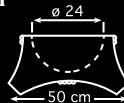

H 353

SMOOTHED DORIC HALF COLUMN

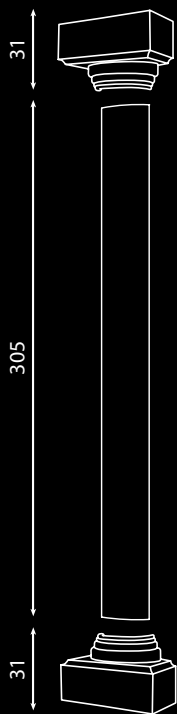

H 365

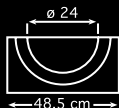
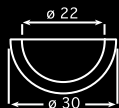
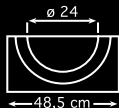

SMOOTHED HALF
PILLAR
CCOL3333



DORIC HALF
CAPITAL
CCOL3326



HALF BASE
CCOL3326



FLUTED HELLENIC HALF COLUMN

HELLENIC HALF
CAPITAL

CCOL3354

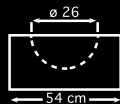
FLUTED SMALL
HALF PILLAR

CCOL3633

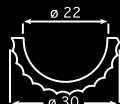

HALF BASE

CCOL3326

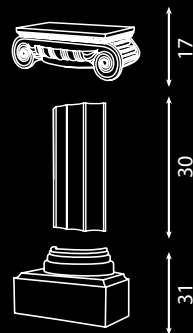

H 76

FLUTED IONIC SMALL HALF COLUMN

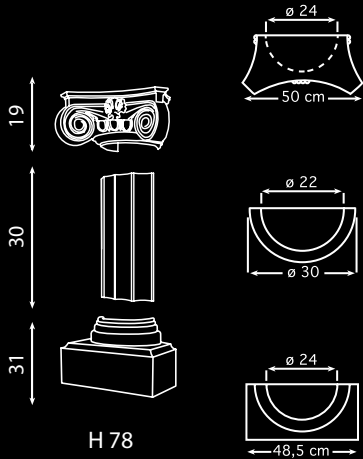

IONIC HALF
CAPITAL
CCOL3334



FLUTED SMALL
HALF PILLAR
CCOL3633



HALF BASE
CCOL3326



FLUTED DORIC SMALL HALF COLUMN

DORIC HALF
CAPITAL
CCOL3326



FLUTED SMALL
HALF PILLAR
CCOL3633

HALF BASE
CCOL3326

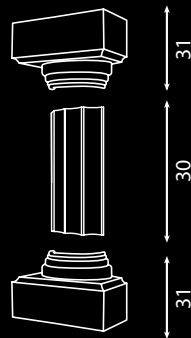
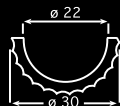
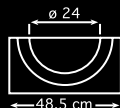

H 90

SMOOTHED HELLENIC SMALL HALF COLUMN

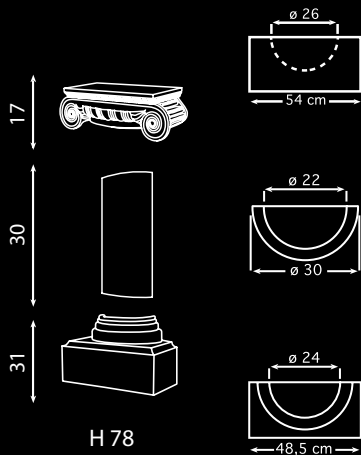
HELLENIC HALF
CAPITAL
CCOL3354SMOOTHED SMALL
HALF PILLAR
CCOL3623HALF BASE
CCOL3326

SMOOTHED IONIC SMALL HALF COLUMN

IONIC HALF
CAPITAL
CCOL3334

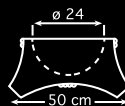

19



SMOOTHED SMALL
HALF PILLAR
CCOL3623

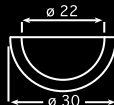

30

HALF BASE
CCOL3326

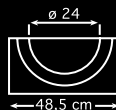

31

H 78

SMOOTHED DORIC SMALL HALF COLUMN

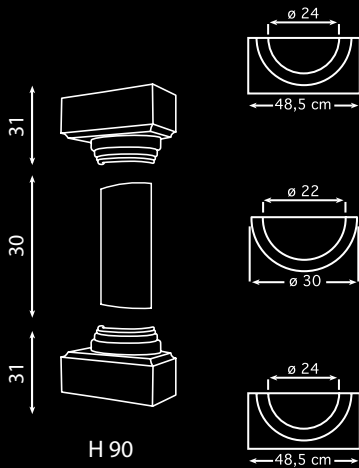
DORIC HALF
CAPITAL
CCOL3326SMOOTHED SMALL
HALF PILLAR
CCOL3623HALF BASE
CCOL3326

The background is a solid red color with a faint, stylized musical staff consisting of five horizontal lines. A soft, white, fluffy cloud is positioned in the upper left quadrant, and a stylized white flower with a long stem is in the lower right quadrant. The text 'AMERICANSTYL' is centered in the middle of the page.

AMERICANSTYL



LE CORNICI
IN "POLISTRUTTURATO"



SIERPROFIELEN UIT
"POLISTRUTTURATO"



"POLISTRUTTURATO"
MOULDINGS



KOPNIZEΣ
"POLISTRUTTURATO"



ZIERPROFILE AUS
"POLISTRUTTURATO"



LISTER AV
"POLISTRUTTURATO"



CORNICHES EN
"POLISTRUTTURATO"



STUKKATURLISTER I
"POLISTRUTTURATO"



MOLDURAS EN
"POLISTRUTTURATO"



"POLISTRUTTURATO"
STUKLISTER



SANCAS EM
"POLISTRUTTURATO"



"POLISTRUTTURATO"
LISTAT



"POLISTRUTTURATO"
PROFILE



"POLISTRUTTURATO"
DÍSZLÉCEK



"POLISTRUTTURATO"
PROFILI



ПЛІНІТУС
"POLISTRUTTURATO"



ПЛИНТУСЫ
"POLISTRUTTURATO"



ПРОФИЛИ
"POLISTRUTTURATO"



LISTWY Z
"POLISTRUTTURATO"



الكرانيش بوليستروتو رڤو



LIŠTY
"POLISTRUTTURATO"



ポリストラート製飾り縁



CORNISE DIN
"POLISTRUTTURATO"

Atmosfere americane con accenni country d'oltreoceano, per uno stile intramontabile e sempre in voga: cornici e angoli per pareti, soffitti, porte e pannellature che personalizzano e scaldano ogni ambiente.

A typical American countryside atmosphere, for a timeless style always in vogue: mouldings and corner elements for walls, ceilings, doors and panels to add warmth and a personal touch to any room.

Amerikanischer Stil mit Anklang zum Countrystil aus Übersee, für unvergängliche und stets moderne Räume: Leisten und Ecken für Wände, Decken, Türen und Paneele zur individuellen, gemütlichen Gestaltung eines jeden Raums.

Неувядающий дух Америки с элементами стиля кантри приобретает все большую популярность. Карнизы, молдинги, потолочные уголки, а также отделка для дверей и панельной обшивки придадут индивидуальность и уют любому помещению.



DADO RAILS AND CEILING BORDERS	175 - 183
CORNER BLOCKS	185 - 201
CEILING CORNICES	203 - 215
WALL PANELING	217 - 219

DADO RAILS AND CEILING BORDERS

A02D



↕ 2 cm

↔ 0,9 cm

A03D



↕ 2,4 cm

↔ 1,1 cm

A01D



↕ 3 cm

↔ 1 cm

A35W



↕ 3,5 cm

↔ 1,5 cm

A10W



↕ 4 cm

↔ 2 cm

A46W

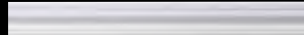

↕ 4,6 cm

↔ 2 cm

A70W



↕ 7 cm

↔ 2 cm

A13W



↕ 8 cm

↔ 2,2 cm

A90P



↕ 9 cm

↔ 1,8 cm



DADO RAIL AND CEILING BORDER A01D



length 200 cm

DADO RAIL AND CEILING BORDER A02D



length 200 cm

DADO RAIL AND CEILING BORDER A03D



length 200 cm



DADO RAIL AND CEILING BORDER A10W

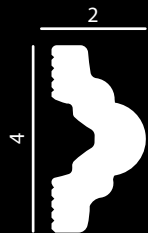

length 200 cm



DADO RAIL AND CEILING BORDER A13W

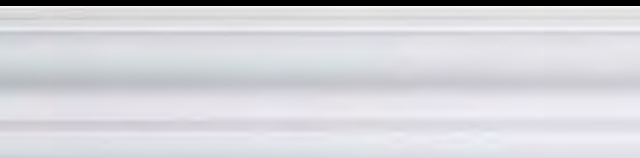

DADO RAIL AND CEILING BORDER A35W



DADO RAIL AND CEILING BORDER A46W



length 200 cm



DADO RAIL AND CEILING BORDER A70W



length 200 cm



DADO RAIL AND CEILING BORDER A90P front

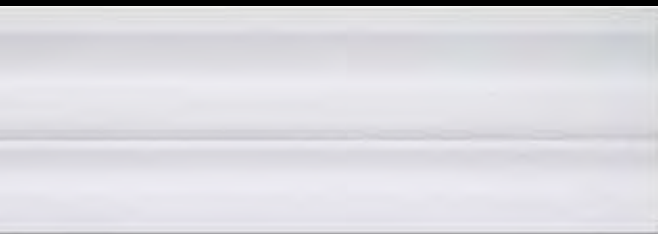

length 200 cm

DADO RAIL AND CEILING BORDER A90P rear

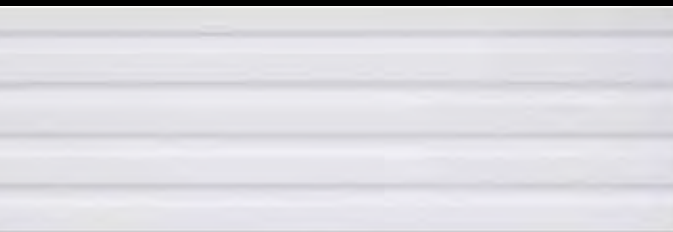

length 200 cm



The background is a solid, vibrant red color. In the upper left corner, there is a faint, light-colored architectural carving of a scroll or acanthus leaf. In the lower right corner, there is another faint, light-colored architectural carving, possibly a corner block or a decorative element of a frame. The text "CORNER BLOCKS" is centered in the middle of the image in a white, serif font.

CORNER BLOCKS

CORNER BLOCK AA02DC



W 12 x H 12

corner for A02D

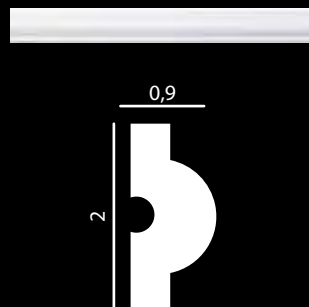

CORNER BLOCK AA02LG



W 18,5 x H 18,5 x R 9

corner for A02D

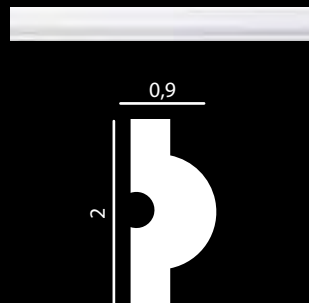

corner for A02D

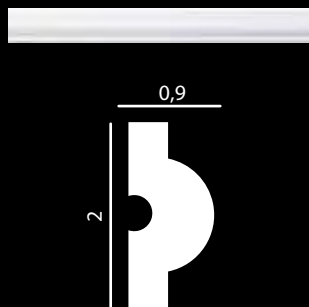

CORNER BLOCK AA02LP



W 8 x H 8 x R 4

corner for A03D

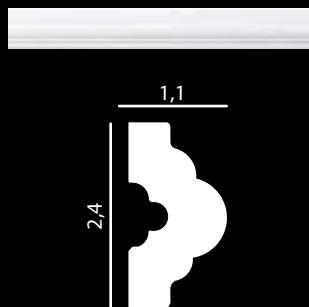

CORNER BLOCK AA03DG

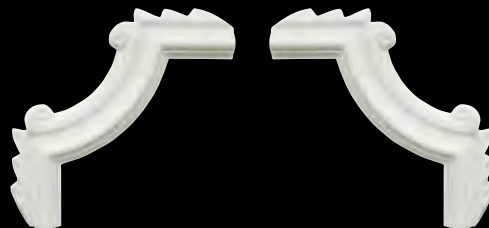

W 16,5 x H 16,5

CORNER BLOCK AA03DP



W 10,3 x H 10,3

corner for A03D



CORNER BLOCK AA03LG



W 20 x H 20 x R 11,5

corner for A03D



corner for A03D



CORNER BLOCK AA03LM



W 15,5 x H 15,5 x r 8,5

corner for A03D



CORNER BLOCK AA03LP



W 10,5 x H 10,5 x R 5

CORNER BLOCK AA10D

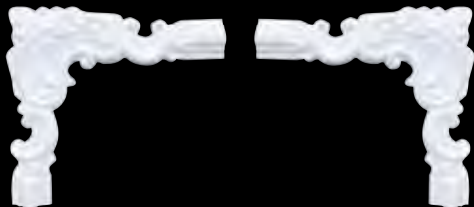

W 20 x H 19

corner for A10W



CORNER BLOCK AA10LG



W 20 x H 20 x R 12

corner for A10W

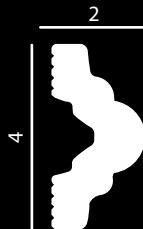

corner for A10W

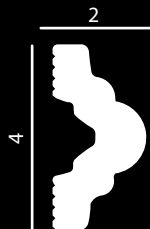

CORNER BLOCK AA10LP



W 15 x H 15 x R 8

corner for A13W

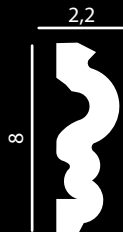

CORNER BLOCK AA13L



W 22,5 x H 22,5 x R 15,5

CIRCLE AC02

 \varnothing 12,5 cm

corner for A02D



CIRCLE AC03

 \varnothing 12,5 cm

corner for A03D



corner for A02D



DECOR AF02DC



W 15,5 x H 6,5

for A03D



DECOR AF03DC



W 15,5 x H 7

DECOR AF03DF



W 15,5 x H 6,5

for A03D



DECOR AF03DG



W 15,5 x H 7

for A03D



for A03D

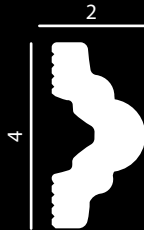

DECOR AF10D



W 23,5 x H 10,8

DECOR AS03OS

for A03D



W 54 x H 17



DECOR AS03OI

for A03D



W 55,5 x H 9



for A03D

DECOR AS03OD



W 54 x H 17

for A03D

DECOR AS03T

W 59 x H 14
1/4 of circle Ø 82

DECOR AT02



W6xH6



for A02D/AA02LG



DECOR AT03



W9xH9

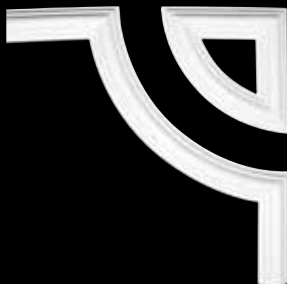

for A02D /AA03LG



CEILING ROSES AR13



W 9 x H 9

CEILING ROSES AR17



Ø 8







CEILING CORNICES

A30T



↕ 3 cm

↔ 3,5 cm

A38C

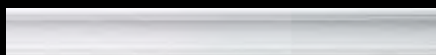

↕ 3,8 cm

↔ 3,8 cm

A15C



↕ 4,3 cm

↔ 4 cm

A45C



↕ 4,5 cm

↔ 4,5 cm

A50T



↕ 5 cm

↔ 5 cm

A18C



↕ 6 cm

↔ 5 cm

A65C



↕ 6,5 cm

↔ 6,5 cm

A16C



↕ 7 cm

↔ 5 cm

A17C



8 cm

12 cm

A19C



8 cm

8 cm

A04C



10 cm

10 cm

A20C



10 cm

11 cm

A22C



13 cm

11 cm

A95D



15,5 cm

13 cm

CEILING CORNICE A04C

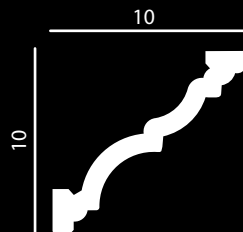
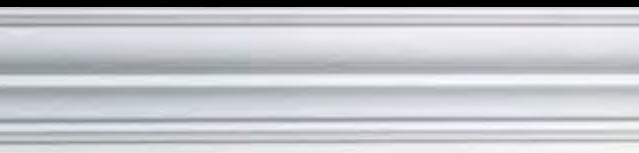

length 200 cm

CEILING CORNICE A15C



AA15CI

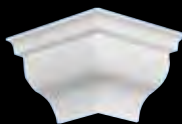

AA15CE

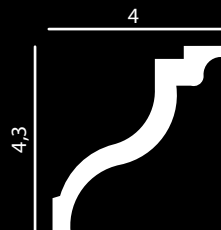

length 200 cm

CEILING CORNICE A16C



length 200 cm



CEILING CORNICE A17C

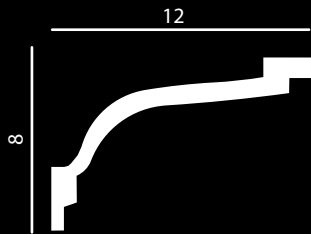

length 200 cm



CEILING CORNICE A18C

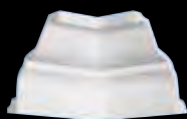

AA18CI



AA18CE

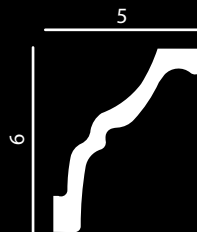

length 200 cm

CEILING CORNICE A19C



AA19CI



AA19CE

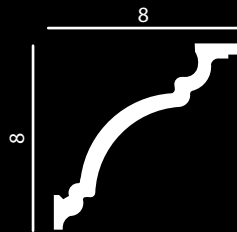

length 200 cm

CEILING CORNICE A20C

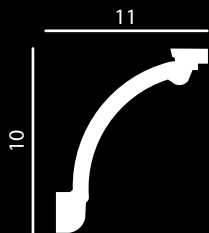

length 200 cm

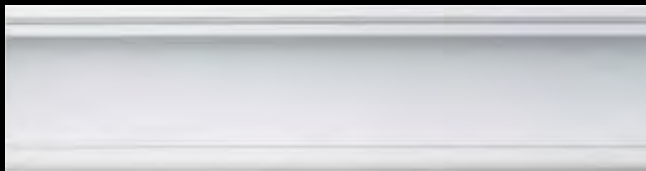

CEILING CORNICE A22C

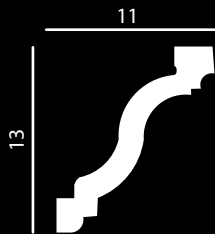

length 200 cm



CEILING CORNICE A30T

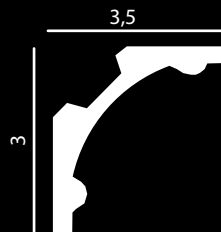

length 200 cm

CEILING CORNICE A38C

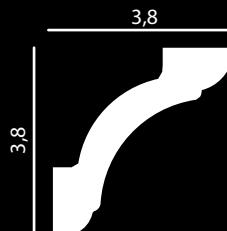

length 200 cm

CEILING CORNICE A45C

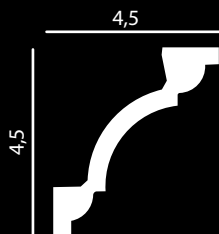

length 200 cm



AA45CI

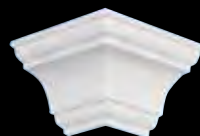

AA45CE

CEILING CORNICE A50T

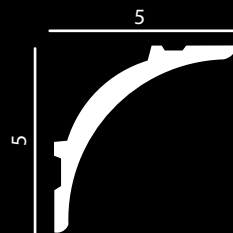
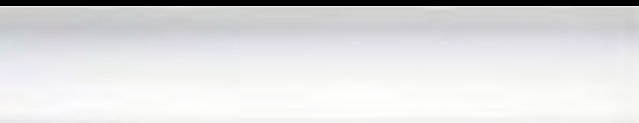

length 200 cm

CEILING CORNICE A65C

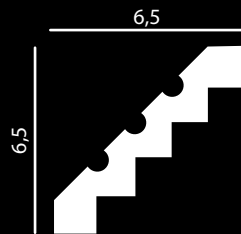
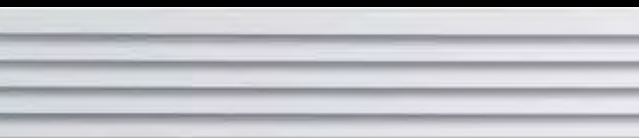

length 200 cm

CEILING CORNICE A95D

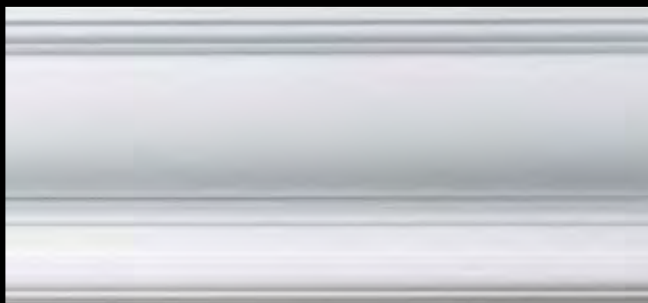
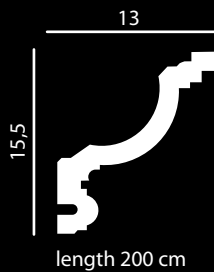





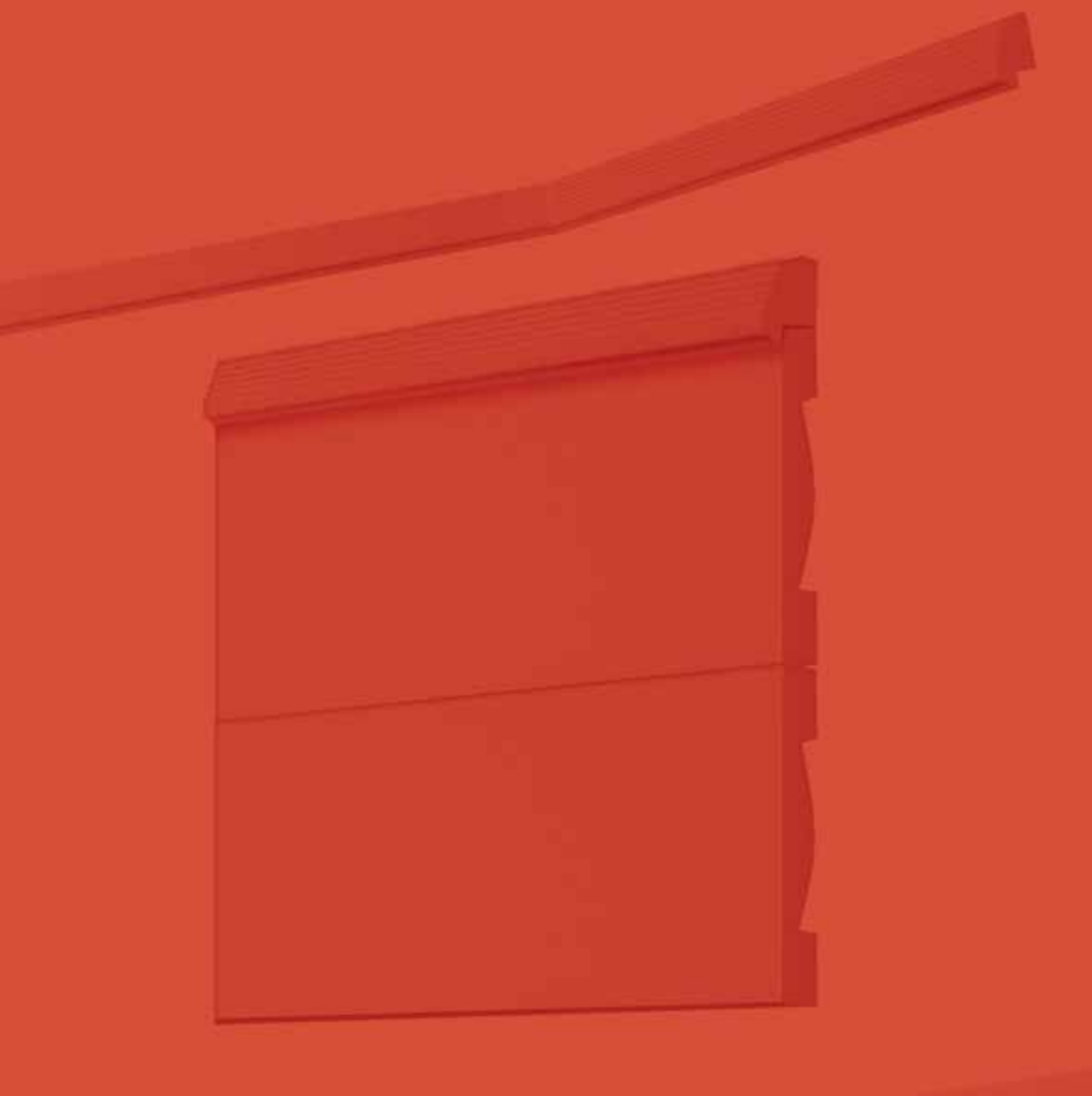



WALL PANELING

WALL PANELING A28Q



length 200 cm

WALL PANELING A91W front

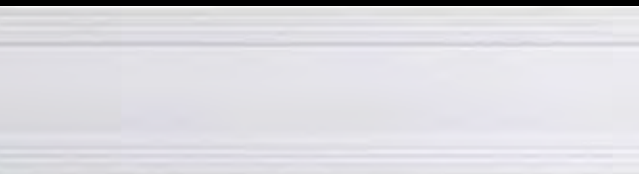

length 200 cm

WALL PANELING A91W rear

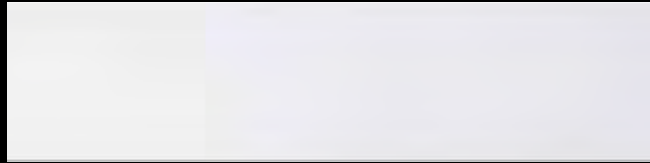
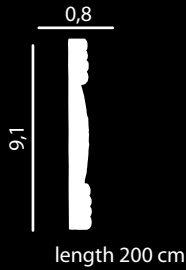

WALL PANELING A28Q & A91W rear





NEWSTYL



I PROFILI IN POLIMERI
ESTRUSI AD ALTA DENSITÀ



GÉËXTRUDEERDE PROFIELEN
UIT HOGE DENSITEIT POLYMEREN



HIGH DENSITY EXTRUDED
POLYMERS PROFILES



ΠΡΟΦΙΛ ΑΠΟ ΕΞΗΛΑΣΜΕΝΑ
ΠΟΛΥΜΕΡΗ ΥΨΗΛΗΣ ΠΥΚΝΟΤΗΤΑΣ



PROFILE AUS EXTRUDIERTEN
POLYMEREN MIT HOHEM
RAUMGEWICHT



MASSIVA LISTER AV
EXTRUDERAD POLYMERPLAST



PLINTHES EN POLYMÈRES
EXTRUDÉES HAUTE DESITÉ



EKSTRUDERTE PROFILER
I POLYMER MED HØY TETTHET



PERFILES DE POLÍMEROS
EXTRUIDOS DE ALTA DESIDAD



HIGH DENSITYL EKSTRUDERET
POLYMER PROFILER



PERFILES DO POLÍMEROS
EXTRUIDOS DE ALTA DESIDADE



SUULAKEPURISTETUISSA PROFIILEISSA
ON KORKEA POLYSTYREENITIHESY



PROFILI EKSTRUDIRANIH
POLIMEROV VISOKE GOSTOTE



NAGYSŰRŰSÉGŰ EXTRUDÁLT
POLISZTIROL PROFILOK



PROFILI OD EKSTRUDIRANIH
POLIMERA VISOKE GUSTOĆE



ПРОФІЛІ З ЕКСТРУДОВАНИХ
ПОЛІМЕРІВ ВИСОКОЇ ЩІЛЬНОСТІ



ПРОФИЛИ ИЗ
ЭКСТРУДИРОВАННЫХ
ПОЛИМЕРОВ В ВЫСОКОЙ
ПЛОТНОСТИ



ПРОФИЛИ ОТ ЕКСТРУДИРОВАН
ПОЛИМЕР



PROFILE Z POLISTYRENU
EKSTRUDOWANEGO
O WYSOKIEJ GĘSTOŚCI



أزار الحائط البوليمر مقذوف
عالية الكثافة



PROFILY Z VYSOCE
ODOLNÉHO POLYSTYRENU



高密度樹脂成型モールディング



PROFILE POLIMERI
EXTRUDATI DE INALTA DENSITATE

I profili innovativi, incredibilmente resistenti ed estremamente facili da applicare, che sanno aggiungere stile contemporaneo e grande eleganza a ogni ambiente.

Innovative profiles, highly resistant and easy to install, to add a touch of contemporary style and elegance to any room.

Die innovativen Profile sind unwahrscheinlich beständig und extrem einfach anzubringen. Sie verleihen jedem Ambiente einen zeitgenössischen Stil und großartige Eleganz.

Иновационные карнизы, отличающиеся исключительной прочностью и простотой в применении, придадут любому помещению современный и элегантный вид.

SKIRTING BOARDS

229 - 238

WALL PROFILES

238 - 239



SKIRTING BOARDS

NW65

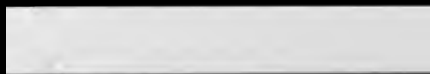

↕ 6,5 cm

↔ 1,3 cm

NW70



↕ 7 cm

↔ 1,5 cm

NF75



↕ 7,5 cm

↔ 0,9 cm

NW75



↕ 7,5 cm

↔ 1,5 cm

NF85



↕ 8,5 cm

↔ 1,2 cm

NF100



↕ 10 cm

↔ 1,5 cm

NF110



Height 10,5 cm

Width 1,5 cm

NF108

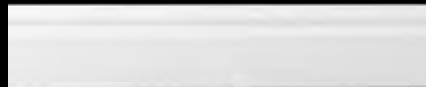

Height 11 cm

Width 1,5 cm

NF125

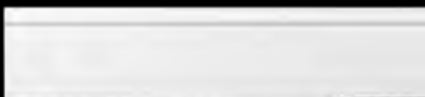

Height 12,5 cm

Width 1,5 cm

NF130

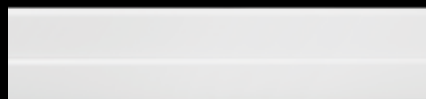

Height 13 cm

Width 1,6 cm

NF140

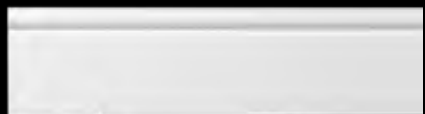

Height 14 cm

Width 1,5 cm

NW148



Height 14,8 cm

Width 1,7 cm





SKIRTING BOARD **NF75**

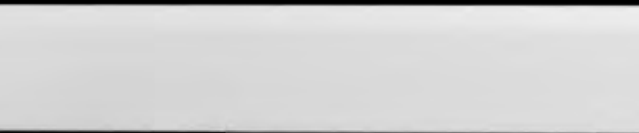

length 200 cm

SKIRTING BOARD **NF85**

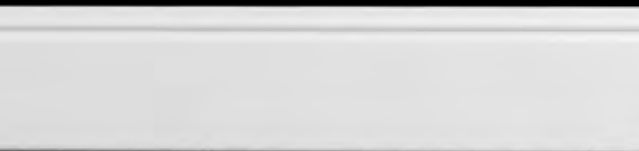

length 200 cm

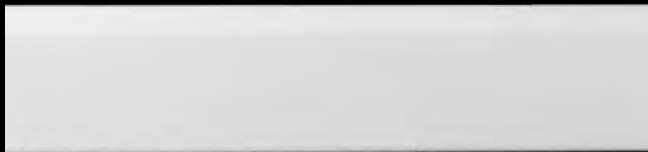
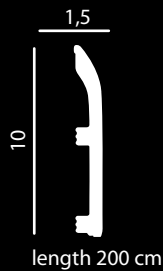
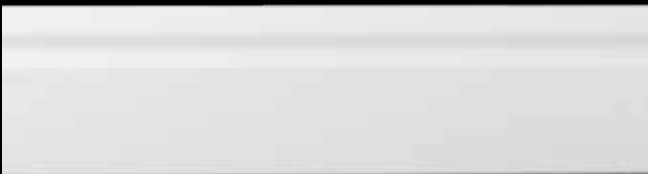
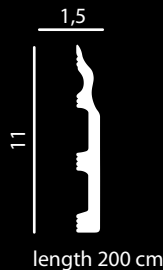
SKIRTING BOARD **NF100**SKIRTING BOARD **NF108**

SKIRTING BOARD NF110

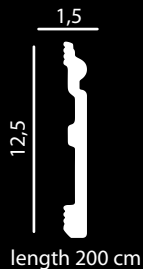
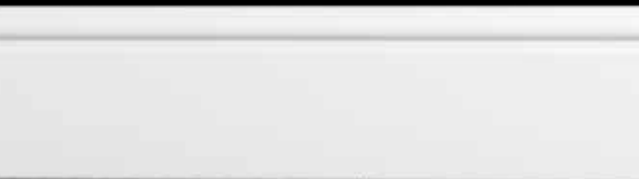
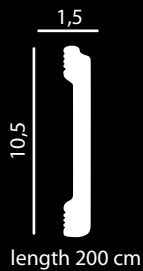
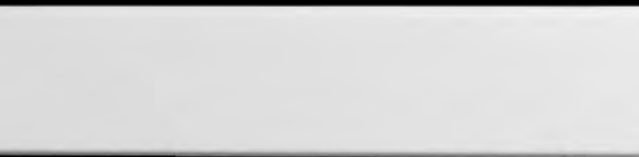

SKIRTING BOARD **NF130**

length 200 cm

SKIRTING BOARD **NF140**

length 200 cm

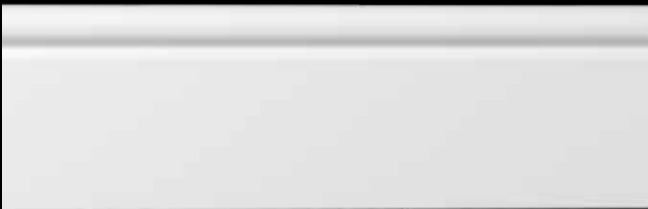

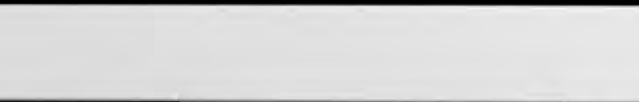
SKIRTING BOARD AND WALL PROFILE **NW65**

length 200 cm

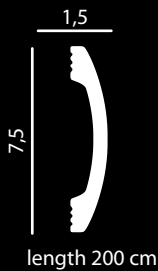
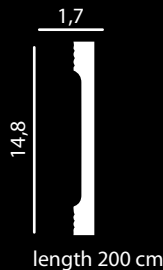

length 200 cm

WALL PROFILE **NW75**SKIRTING BOARD AND WALL PROFILE **NW148**

The background of the image consists of several overlapping, semi-transparent diagonal lines in a reddish-orange hue, creating a sense of depth and movement. The lines intersect to form a grid-like pattern of diamond shapes. Centered in the middle of the image is the text "PROFILSTYL" in a white, serif, all-caps font.

PROFILSTYL



I BATTISCOPI E
GLI ANGOLARI



AFTIMMERINGGEN



SKIRTINGS AND
CORNER PROFILES



ΚΟΒΑΤΕΠΙ ΑΠΟ ΣΚΛΗΡΗ
ΠΟΛΥΣΤΕΡΙΝΗ



PROFILE & SOCKELLEISTEN



SÛPÛRGELIK



PLINTHES



GOLVSOCKLAR OCH HÖRNLISTER



ZÓCALOS Y CANTONERAS



GULVLISTER



RODAPÉS PARA HABITAÇÃO



GULVLISTER



JALKALISTAT



ИМІТАЦІЯ ТІЛА ЛОПОК



PROFILI

ПЛІНТУС ДЛЯ ПІДЛОГИ ТА
СТІНОВИИ ПРОФЛЬ

PROFILI



ПЕРВАЗИ И ГЛИ



ПЛІНТУСИ ДЛЯ ПОЛА И СТЕИ



ازار الحائط

LISTWY PRZYPODLOGOWE,
KATOWNIKI

室内裝飾品

PADLAHOVÉ A STENOVÉ LISTY
PLINTE SI UNGHIULARI

La nostra casa è per noi un'opera d'arte, e Profilstyl è la sua degna rifinitura. Profili, battiscopa, angolari in polistrutturato, in ogni forma e colore per sottolineare la bellezza della struttura della dimora e i suoi arredi.

Our home is a work of art to any of us. And Profilstyl is a perfect finishing touch. Profiles, skirtings, corner elements are all made of a special material ("polistrutturato"), in every shape and color, to emphasize the beauty of the home and its furnishings.

Unser Haus ist ein Kunstwerk für uns und Profilstyl ist die richtige Verzierung dafür. Profile, Sockelleisten, Eckprofile aus „Polistrutturato“ in jeder Form und Farbe, zur Hervorhebung der Struktur des Hauses und dessen Einrichtung.

Для нас наш дом – произведение искусства, а Profilstyl – достойная для такого дома отделка. Профили, плинтусы, уголки из «polistrutturato» любой формы и цвета подчеркнут красоту помещения и его обстановки.

WALL PROFILES	254
CORNER PROFILES	255 - 257
SKIRTING BOARDS	258 - 261





SKIRTING &
CORNER PROFILES

PA22BN



↕ 2,2 cm

↔ 2,2 cm

PP23BN



↕ 2,3 cm

↔ 0,6 cm

PA28BN



↕ 2,8 cm

↔ 2,8 cm

PAB30BN



↕ 3 cm

↔ 3 cm

PB55BN

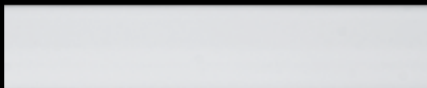

Height 5,5 cm

Width 2 cm

PB68BN

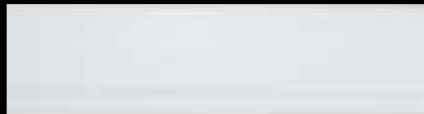

Height 6,8 cm

Width 0,3 cm

PB75BN

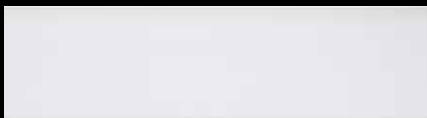

Height 7,5 cm

Width 0,9 cm

BP110BN

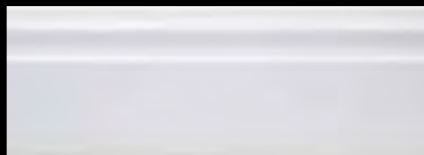

Height 11 cm

Width 1,5 cm





WALL PROFILE PP23BN



length 200 cm



PP23GC



PP23GS



PP23NR



PP23NC



PP23MG



PP23RV

CORNER PROFILE WHITE PA22BN

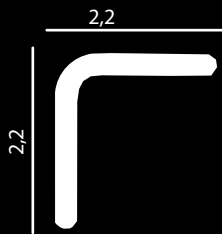

length 200 cm



PA22GC



PA22GS



PA22NR



PA22NC



PA22MG



PA22RV

CORNER PROFILE PA28BN

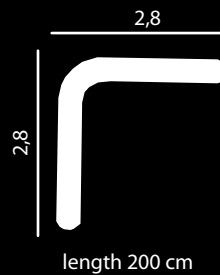

PA28GC



PA28GS



PA28NR



PA28NC



PA28MG



PA28RV

CORNER PROFILE BAROCCO PAB30BN

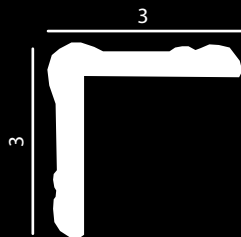

length 200 cm



PAB30GC



PAB30GS



PAB30NR



PAB30NC



PAB30MG



PAB30RV

SKIRTING BOARD PB55BN

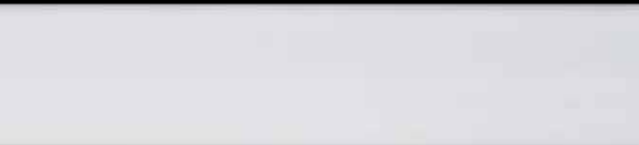

length 200 cm



PB55LC



PB55LS



PB55NR

SKIRTING BOARD PB68BN



length 200 cm

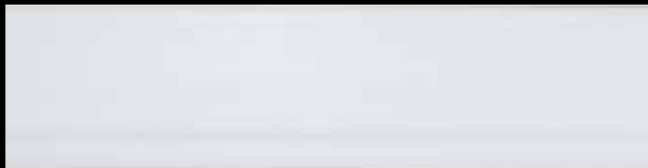

PB68GL



PB68RS



PB68VD



PB68BL



PB68GC



PB68GS



PB68NR



PB68NC



PB68MG



PB68RV

SKIRTING BOARDS PB75BN



length 200 cm



PB75GC



PB75GS



PB75NR



PB75NC



PB75MG



PB75RV

SKIRTING BOARDS PB 1 10BN



length 200 cm

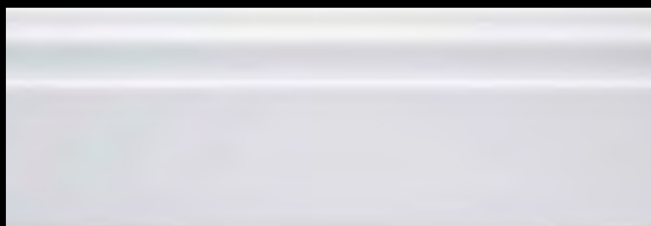

PB110LC



PB110LS



PB110NR









BRICKSTYL



LE CORNICI PER ESTERNO



GEVELPROFIELEN



EXTERIOR MOULDINGS



KOPNIZES ΕΞΩΤΕΡΙΚΟΥ ΧΩΡΟΥ



FASSADENPROFILE



UTVÄNDIGA LISTER



CORNICHES POUR FACADES



UTVENDIGE LISTER



MOLDURAS DECORATIVAS PARA EXTERIORES



FACADELISTER



PERFIS PARA EXTERIOR



ULKOKÄYTTÖÖN TARKOITETUT LISTAT



DECORATIVNI FASADNI PROFILI



HOMLOKZATPROFIL



FASADNI PROFILI



ФАСАДНІ ПРОФІЛИ



ФАСАДНЫЕ ПРОФИЛИ



ФАСАДНІ ПРОФИЛИ



GZYMSY ZEWNĘTRZNE



الكرانيش في الهواء الطلق



LIŠTY PRO ÚPRAVU FASÁDY



室外用飾り縁



CORNISE PENTRU EXTERIOR

Linee e tratti Liberty per decorare le pareti esterne di strutture ed abitazioni, come cornicioni, davanzali, fregi, porte e finestre: segni di stile e originalità per qualsiasi tipo di edificio.

The linear features of the Liberty style are found in this line, used to decorate the exterior walls of residences and other buildings: ledges, windowsills, friezes, doors and windows that add style and uniqueness to any building.

Jugendstil-Dekorationen für Außenfassaden:
Rahmen, Fensterbänke, Frieze, Türen und Fenster
sorgen auf jedem Gebäude für eine stilvolle und
originelle Ausführung.

Линии и штрихи в стиле «Модерн» украсят фасад и
внутренние помещения. Стильные и оригинальные
консоли, подоконники, фризы, двери и окна
подойдут для любого вида здания.

WINDOW AND DOOR SURROUNDS	273 - 289
WINDOW SILLS	291 - 299
EAVE CORNICES	301 - 305
CORNER PROFILES	307 - 311
EXTERIOR BASEMENT TRIMS	313 - 315
PILASTERS	316 - 319
CONSOLES-STONES KEYSTONES	321 - 329



WINDOW AND DOOR SURROUNDS

BM9002

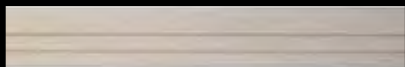

↕ 7 cm

↔ 2 cm

BM9000



↕ 9 cm

↔ 2,5 cm

BM9013



↕ 10 cm

↔ 4 cm

BM9014

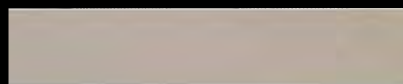

↕ 10 cm

↔ 4 cm

BM9016



↕ 10 cm

↔ 4,5 cm

BM9017



↕ 10 cm

↔ 3 cm

BM9018



↕ 10 cm

↔ 3,5 cm

BM9019

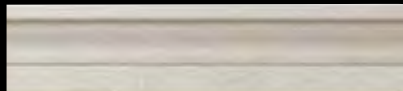

↕ 11 cm

↔ 4 cm

BM9012



Height: 11,5 cm

Width: 3 cm

BM9015



Height: 11,5 cm

Width: 4 cm

BM9021

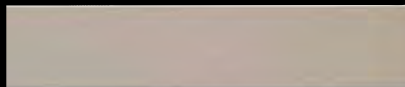

Height: 12 cm

Width: 2,5 cm

BM9003

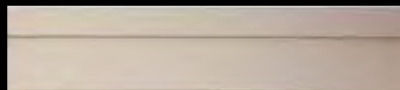

Height: 13,5 cm

Width: 2,5 cm

BM9001

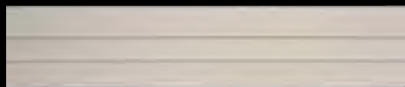

Height: 14 cm

Width: 3 cm

BM9011

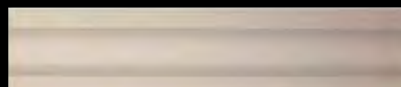

Height: 14,5 cm

Width: 4 cm

BL9202

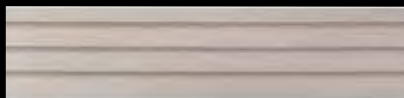

Height: 14,5 cm

Width: 3 cm

BM9024

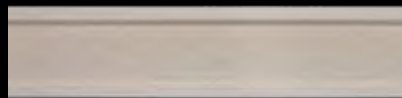

Height: 14,5 cm

Width: 4 cm

BM9022

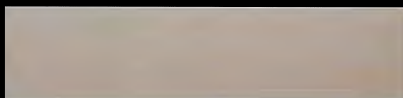

↕ 18 cm

↔ 3,5 cm

BM9010



↕ 18 cm

↔ 4,5 cm

BM9020



↕ 20 cm

↔ 4 cm

BM9023

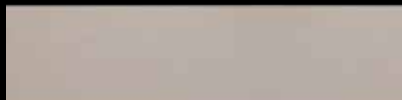

↕ 25 cm

↔ 4 cm

BM9009

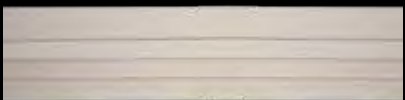

↕ 25 cm

↔ 4 cm

BM9025

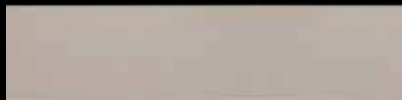

↕ 30 cm

↔ 4 cm



WINDOW AND DOOR SURROUND **BL9202**

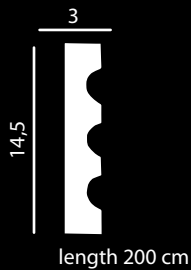
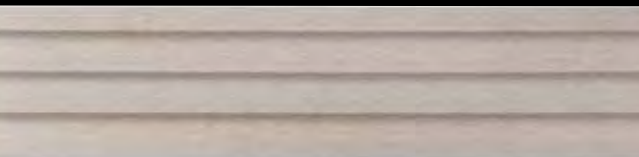

WINDOW AND DOOR SURROUND **BM9000**

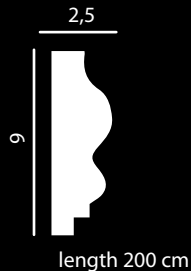
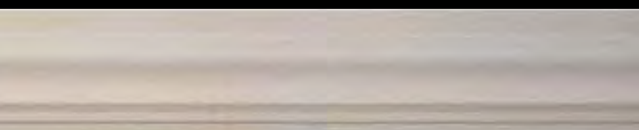

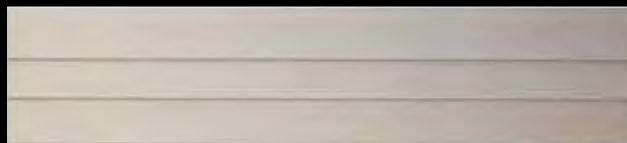
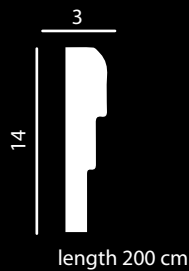
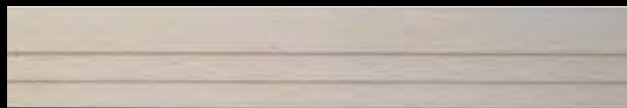
WINDOW AND DOOR SURROUND **BM9001**WINDOW AND DOOR SURROUND **BM9002**

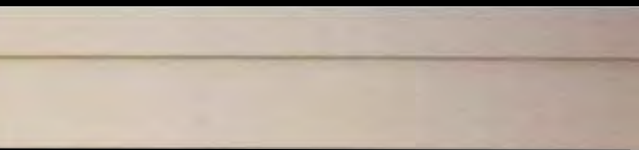
WINDOW AND DOOR SURROUND **BM9003**

length 200 cm

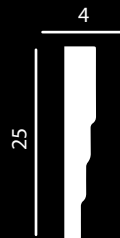
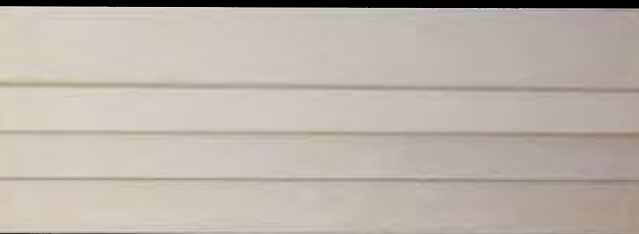
WINDOW AND DOOR SURROUND **BM9009**

length 200 cm

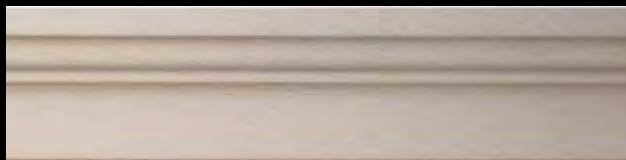
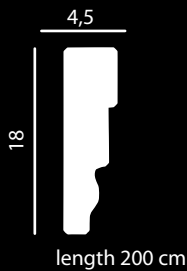
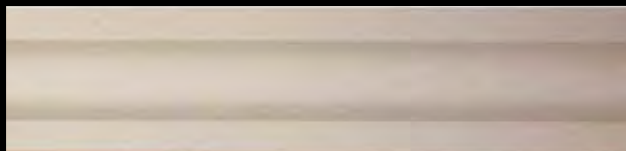
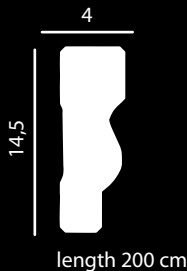
WINDOW AND DOOR SURROUND **BM9010**WINDOW AND DOOR SURROUND **BM9011**

WINDOW AND DOOR SURROUND **BM9012**

length 200 cm

WINDOW AND DOOR SURROUND **BM9013**

length 200 cm

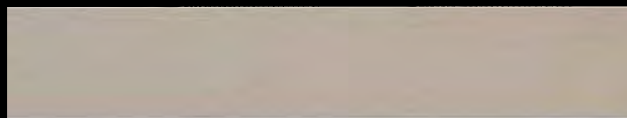
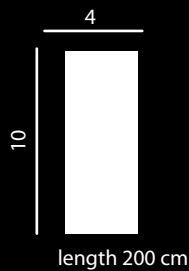
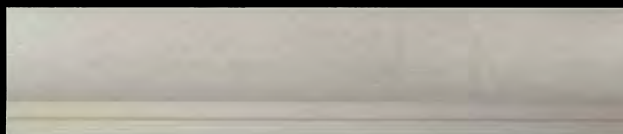
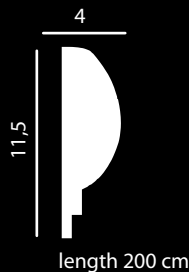
WINDOW AND DOOR SURROUND **BM9014**WINDOW AND DOOR SURROUND **BM9015**

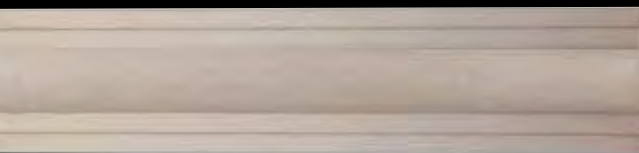
WINDOW AND DOOR SURROUND **BM9016**

length 200 cm

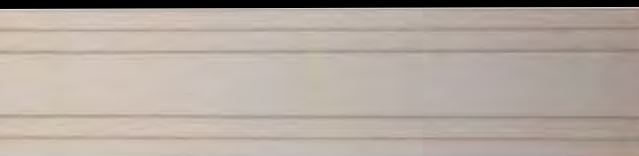
WINDOW AND DOOR SURROUND **BM9017**

length 200 cm

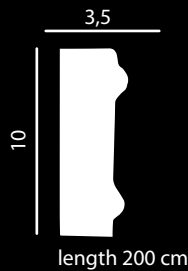
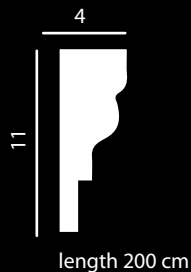
WINDOW AND DOOR SURROUND **BM9018**WINDOW AND DOOR SURROUND **BM9019**

WINDOW AND DOOR SURROUND **BM9020**



length 200 cm

WINDOW AND DOOR SURROUND **BM9021**

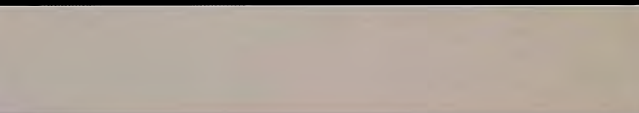

length 200 cm

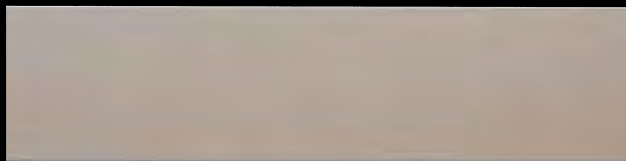
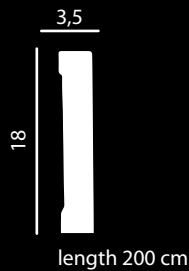
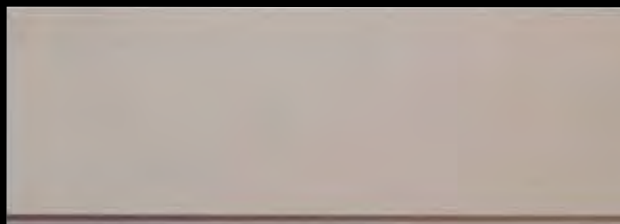
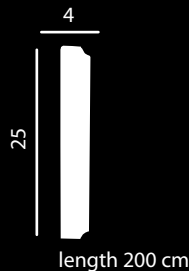
WINDOW AND DOOR SURROUND **BM9022**WINDOW AND DOOR SURROUND **BM9023**



WINDOW AND DOOR SURROUND **BM9024**

length 200 cm

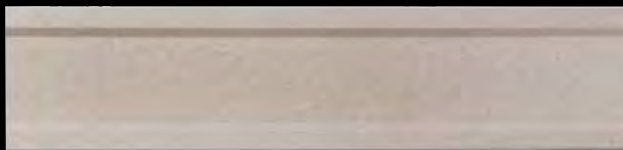
WINDOW AND DOOR SURROUND **BM9025**

length 200 cm

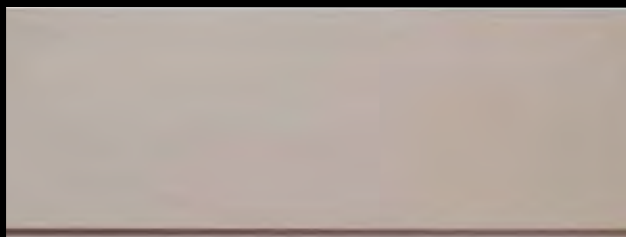





WINDOW SILLS

BF9012

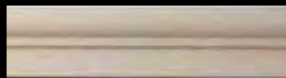

↕ 7 cm

↔ 5,5 cm

BF9014

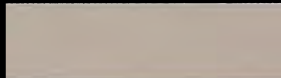

↕ 8 cm

↔ 7 cm

BF9004

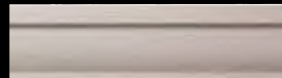

↕ 11,5 cm

↔ 7 cm

BF9010



↕ 11,5 cm

↔ 8,5 cm

BF9011

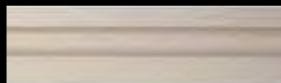

↕ 11,5 cm

↔ 7 cm

BAF9011



↕ 11,5 cm

↔ 7 cm

BF9001



↕ 12 cm

↔ 7 cm

BF9013

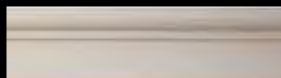

↕ 13 cm

↔ 5,5 cm

BF9003



↕ 14,5 cm

↔ 9 cm

BF9095



↕ 19 cm

↔ 9 cm

BF9002



↕ 19,5 cm

↔ 11 cm

WINDOW SILL BF9001

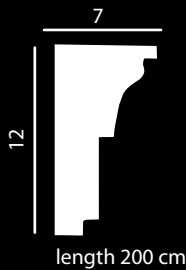

WINDOW SILL BF9002

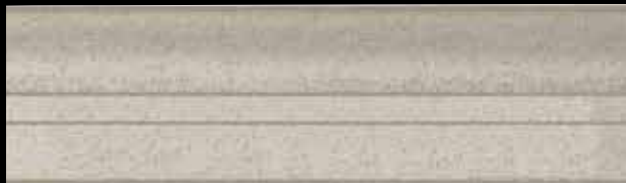

WINDOW SILL **BF9003**



length 200 cm

WINDOW SILL **BF9004**



length 200 cm

WINDOW SILL BF9010

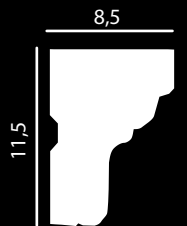

length 200 cm

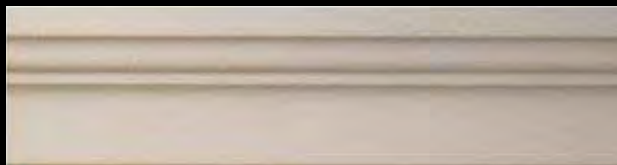

WINDOW SILL BF9011

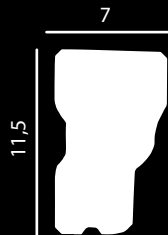

length 200 cm

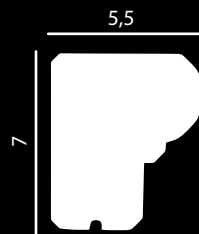
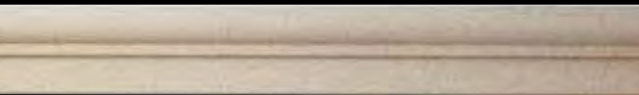

WINDOW SILL **BF9012**

length 200 cm

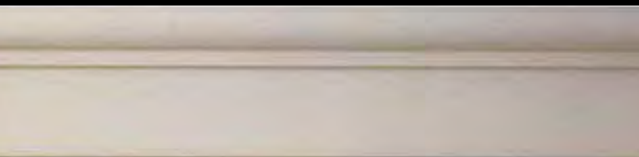
WINDOW SILL **BF9013**

length 200 cm

WINDOW SILL BF9014

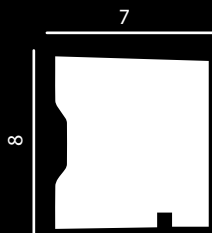

length 200 cm

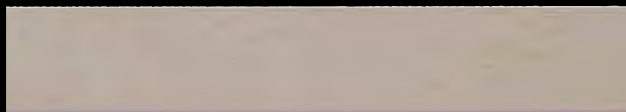

WINDOW SILL BF9095



length 200 cm



HEADER BAF9011



for BF9011

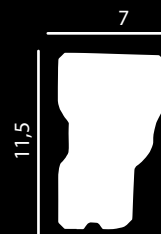
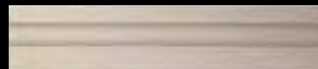

length 200 cm



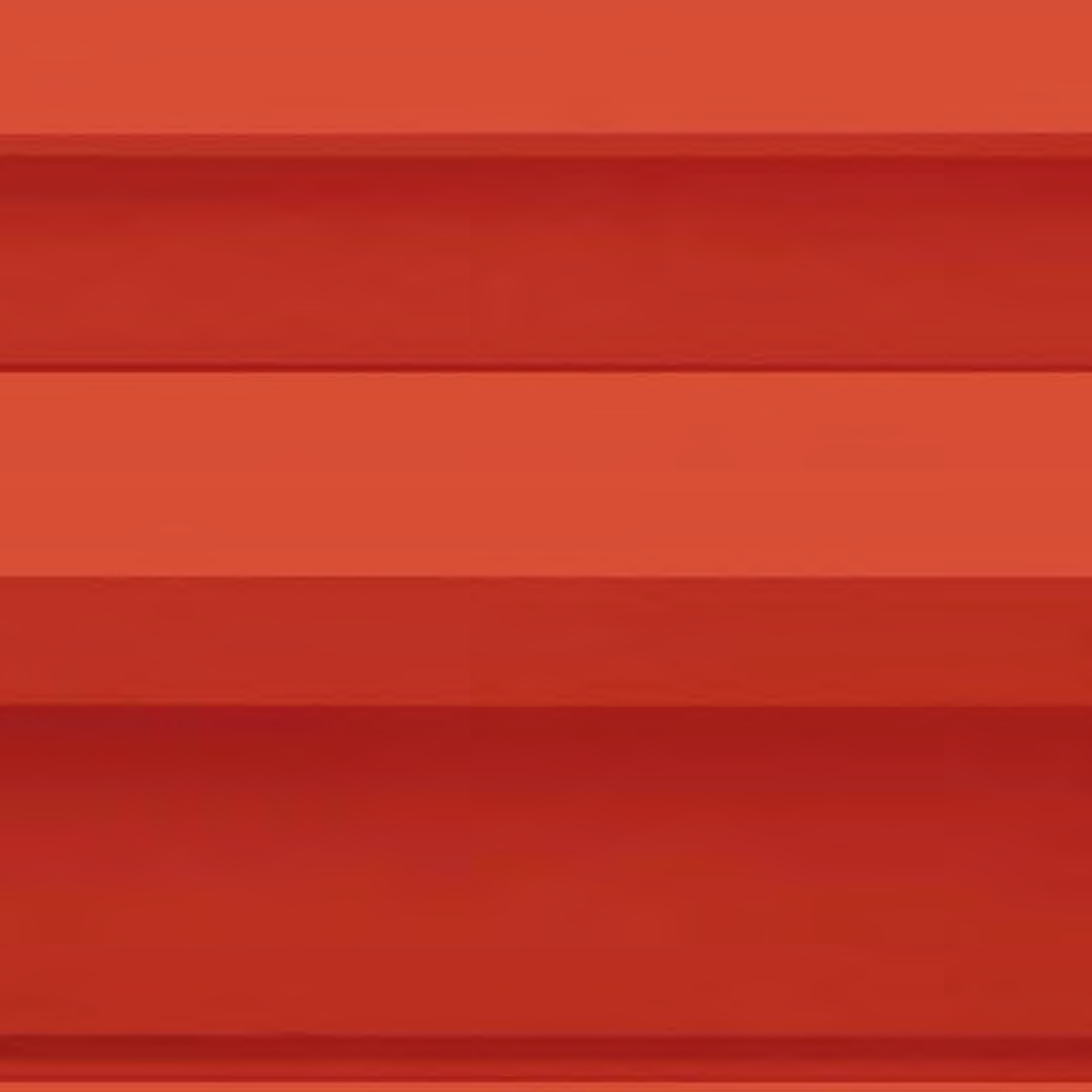

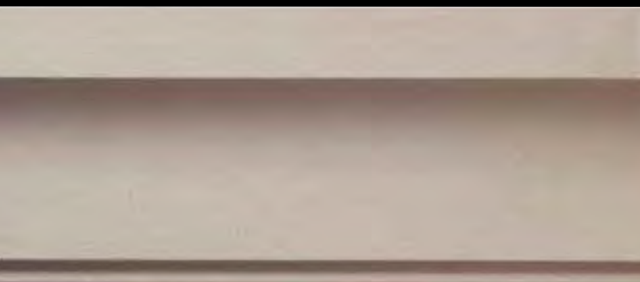
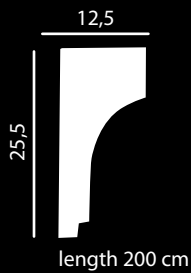
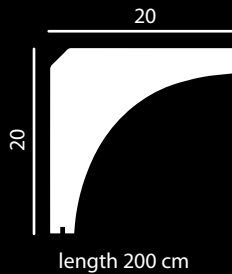

EAVE CORNICES

EAVE CORNICE **BF9055**EAVE CORNICE **BG9020**

EAVE CORNICE **BG9030**





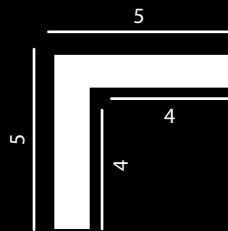
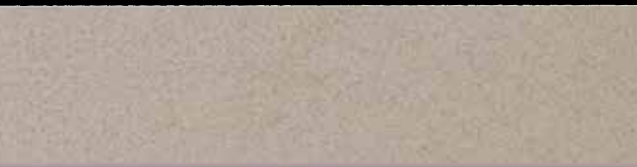

CORNER PROFILES

CORNER PROFILE **BP9004**

length 200 cm

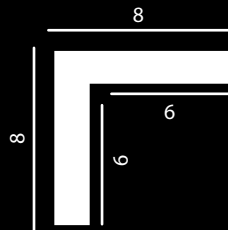
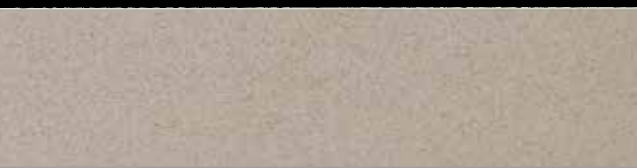
CORNER PROFILE **BP9006**

length 200 cm

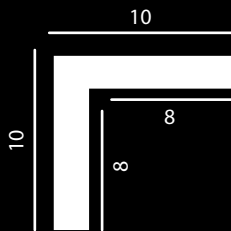
CORNER PROFILE **BP9008**

length 200 cm

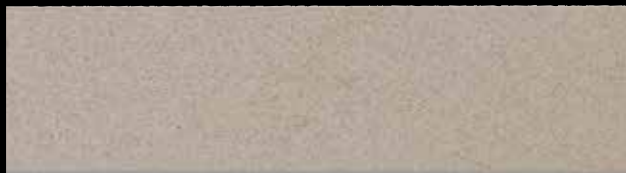
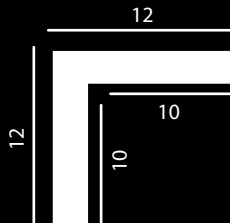
CORNER PROFILE **BP9010**

length 200 cm

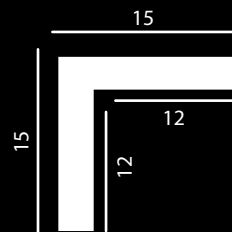
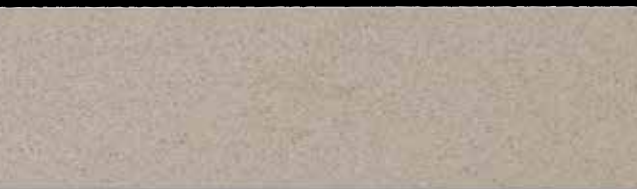

CORNER PROFILE **BP9012**

length 200 cm

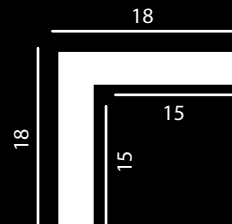
CORNER PROFILE **BP9015**

length 200 cm

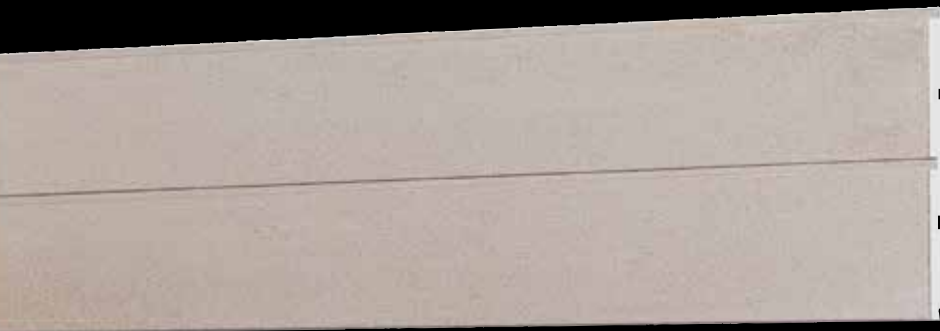

EXTERIOR BASEMENT TRIMS

EXTERIOR BASEMENT TRIM **BP9027**

length 200 cm

H 60 (usable size 59,5) x D 3

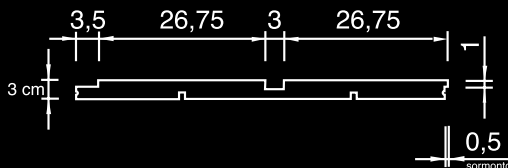

EXTERIOR BASEMENT TRIM BP9054



H 60 (usable size 59,5) x D 3

length 200 cm



The image features a dark red background with a large, faint, light red decorative pilaster centered in the upper half. The pilaster has a capital with three distinct fluted sections and a base with two fluted sections. In the lower half, there is a faint, light red architectural detail that appears to be a corner or a joint of a wall or ceiling, also rendered in a slightly different shade of red. The word "PILASTERS" is written in a white, serif font, centered horizontally and positioned between the pilaster and the architectural detail.

PILASTERS

CAPITAL/BASE PILASTER BL9201



W 21 x H 15 x D 7

DOOR AND WINDOW FRAME BL9202

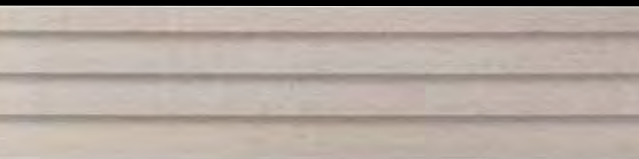

length 200 cm

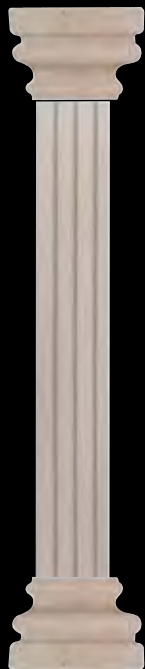

BL9201

BL9202

BL9201

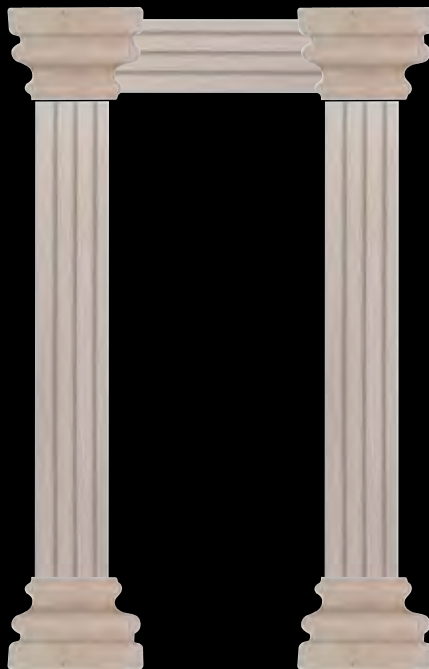

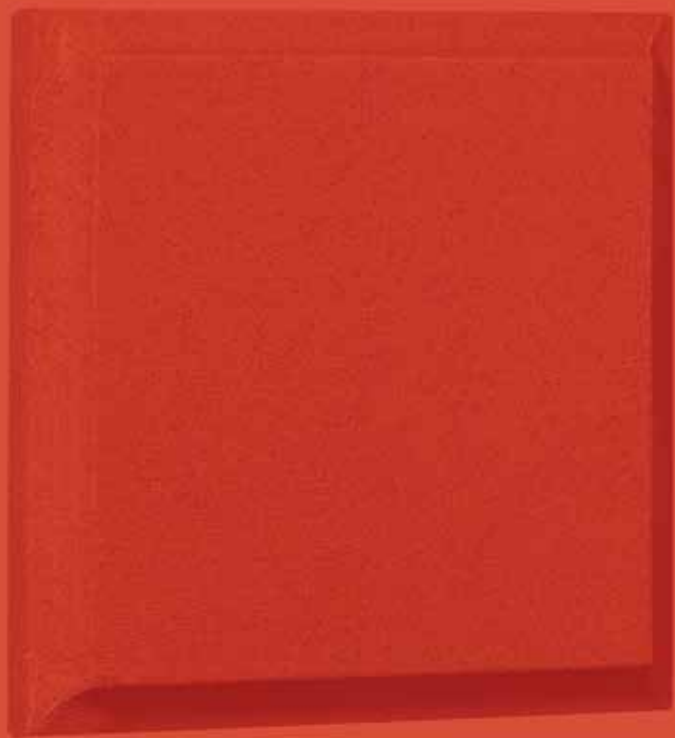



CONSOLES - STONES
KEYSTONES



CONSOLE **BC9001**

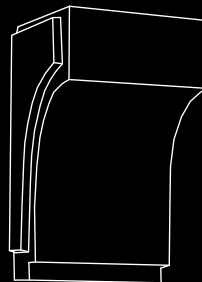

W 19 x H 30 x D 15



CONSOLE **BC9002**

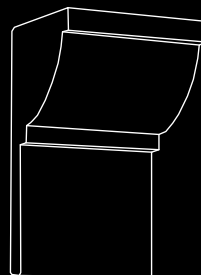

W 19 x H 29,5 x D 16,5

CONSOLE BC9005

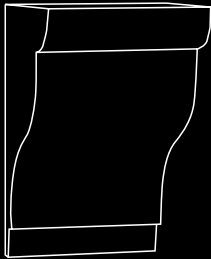

W 19 x H 25 x D 20



STONE BB9010

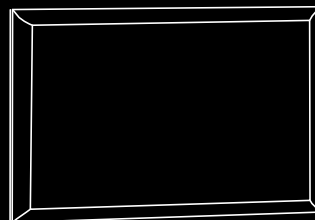

W 37,5 x H 25 x D 4

STONE BB9011

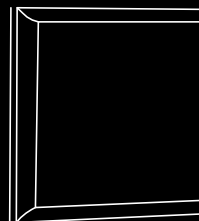

W 25 x H 25 x D 4

STONE BB9020

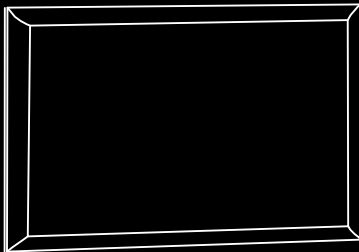

W 50 x H 30 x D 4



STONE BB9021

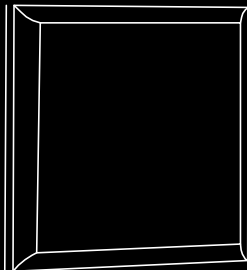

W 30 x H 30 x D 4





STONE **BB9022**

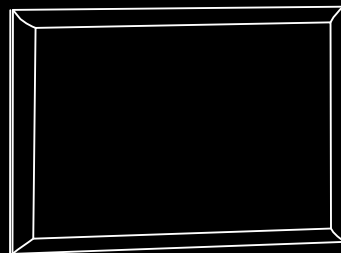

W 40 x H 30 x D 4



KEystone **BS9001**

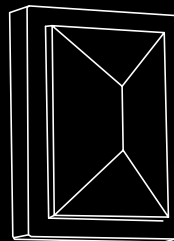

W 15 x H 20 x D 7,5

KEYSTONE BS9002

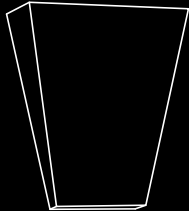

W 17 x H 20 x D 9



KEYSTONE BS9010

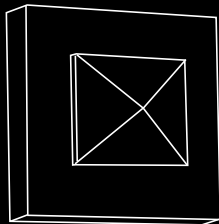

W 20 x H 20 x D 7





KEYSTONE **BS9011**

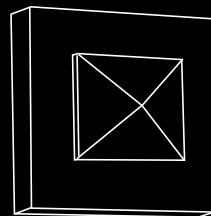

W 14,5 x H 14,5 x D 6,5



KEYSTONE **BS9012**

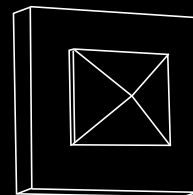

W 11,5 x H 11,5 x D 4,5

KEYSTONE BS9013

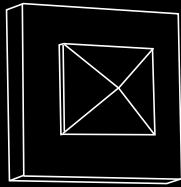

W 10xH 10xD 3



KEYSTONE BS9014

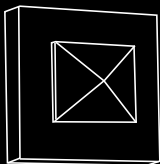

W 8xH 8xD 3



The image features a solid red background with several semi-transparent, light red wooden architectural elements scattered across it. These elements include a long, tapered beam at the top, a curved decorative piece on the left, a rectangular block on the right, and another long beam at the bottom. The word "WOODSTYL" is centered in white, bold, uppercase letters.

WOODSTYL



LE TRAVI IN POLIURETANO



POLYURETHAAN BALKEN



POLYURETHANE BEAMS



ΔΟΚΑΡΙΑ ΠΟΛΥΟΥΡΕΘΑΑΝΗΣ



BALKEN AUS POLYURETHAN



TAKBALKAR AV POLYURETAN



POUTRES EN POLYURÉTHANE



BJELKEN AV POLYURETHAN



VIGAS DE POLIURETANO



STRÅLEN I POLYURETHAN



BARROTÉS EM POLIURETANO



POLYURETAANIPALKIT



TRAMOVJE IZ POLIURETAN



POLIURETÁN TARTÓ



POLIURETAN GREDA



БАЛКИ ПОЛІУРЕТАНОВІ



БАЛКИ ИЗ ПОЛИУРЕТАНА



ГРЕДИ ОТ ПОЛИУРЕТАН



BELKI POLIURETANOWE



الحزمة البولوي يوريثين



POLIURETANOVÉ TRÁMY



ポリウレタン製梁



GRINDE DIN POLIURETAN

Travi rustiche in poliuretano per donare calore e un tono rurale all'ambiente, capitelli, tasselli e lastre che ricreano tutta l'emozionante atmosfera del legno.

Noce, rovere e mogano: in pochi gesti il soffitto si trasforma in un capolavoro dalle emozionanti tinte legnose.

Polyurethane rustic beams to add warmth and a touch of countryside atmosphere to the setting: capitals, listels and slabs that recreate the warmth feelings of natural wood. Walnut, oak and mahogany: the ceiling is transformed in just a few steps, into a true masterpiece that transmits the special feelings of natural wood and its many nuances.

Rustikale Polyurethan Balken verleihen dem Raum Wärme und einen ländlichen Stil. Kapitelle, Einsatzstücke und Platten lassen die schöne Holzatmosphäre entstehen. Nussbaum, Eiche und Mahagoni: In nur wenigen Handgriffen verwandelt sich die Decke in ein Meisterwerk aus Holzönen.

Декоративные балки придадут помещению тепло и уют деревенского дома. Капители, резные украшения и облицовочные панели помогут создать атмосферу, присущую деревянным постройкам. Орех, дуб и красное дерево: несколько штрихов – и потолок, излучающий тона живого дерева, преобразится в произведение искусства.



ANCIENT RUSTIC BEAMS 339 - 353

MODERN BEAMS 355 - 367

The image features three pieces of weathered, rustic wood beams against a solid reddish-orange background. One beam is positioned at the top, another at the bottom left, and a third at the bottom right. Each beam shows natural wood grain, knots, and signs of age. The text 'ANCIENT RUSTIC BEAMS' is centered in the middle of the image in a white, serif font.

ANCIENT RUSTIC
BEAMS

WT6BN



↕ 6 cm

↔ 10 cm

WT11BN



↕ 11 cm

↔ 10,5 cm

WT13BN



↕ 11 cm

↔ 21 cm

WT15BN

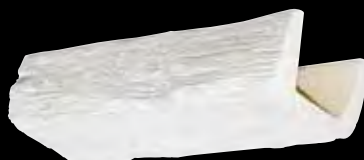

↕ 15 cm

↔ 21,5 cm

WT23BN



↕ 19 cm

↔ 21 cm

WT21BN

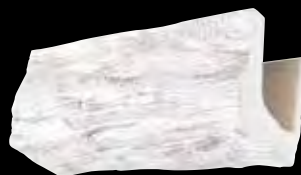

↕ 21 cm

↔ 17 cm

WT28BN



◆ 24 cm

◀ 28 cm

WT30BN



◆ 30 cm

◀ 41 cm

WTL28BN



◆ 5 cm

◀ 28 cm

WTC106BN



◆ 11 cm

◀ 11 cm

WTC111BN



◆ 13 cm

◀ 11 cm

WTC126BN



◆ 18,5 cm

◀ 17 cm

WTX211BN



⬆ 15,5 cm

⬅ 13 cm

WTX206BN



⬆ 28 cm

⬅ 25 cm

WTX226BN



⬆ 28 cm

⬅ 25 cm

WTFGBN



⬆ 4,5 cm

⬅ 100 cm



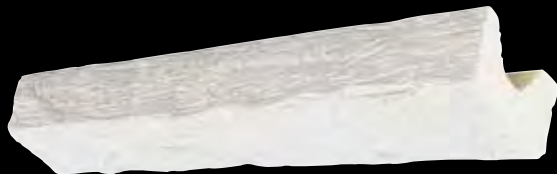

WT6 NC

ANCIENT RUSTIC BEAM WT6BN

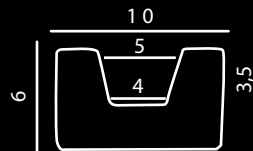

length 300 or 450 cm



WT11 NC

ANCIENT RUSTIC BEAM WT11BN

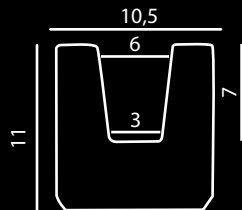

length 300 or 450 cm

ANCIENT RUSTIC BEAM WT13BN

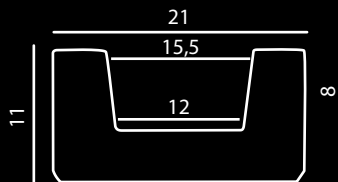

length 300 or 450 cm

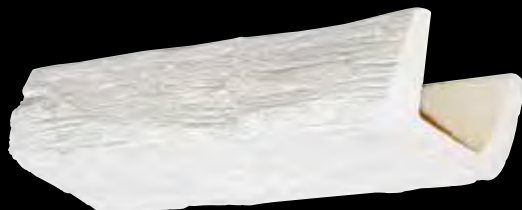

WT13 NC

ANCIENT RUSTIC BEAM WT15BN

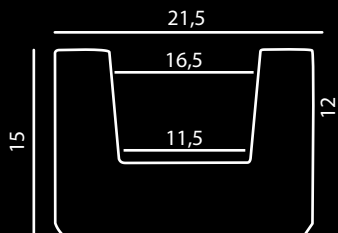

length 300 or 450 cm

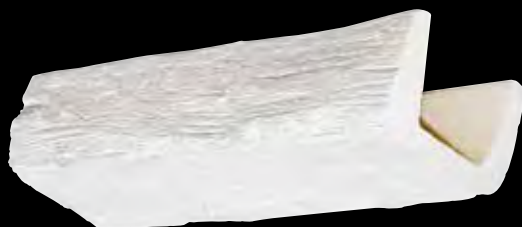

WT15 NC

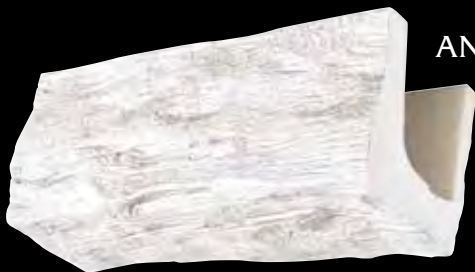
ANCIENT RUSTIC BEAM **WT21BN**

WT21 NC

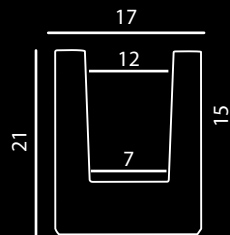

length 300 or 450 cm

ANCIENT RUSTIC BEAM **WT23BN**

WT23 NC

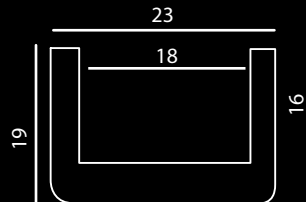

length 300 or 450 cm

ANCIENT RUSTIC BEAM WT28BN

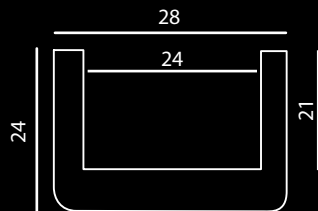

length 300 or 450 cm



WT28 NC

ANCIENT RUSTIC BEAM WT30BN

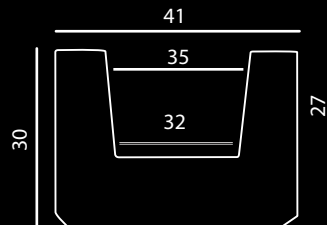

length 300 or 450 cm

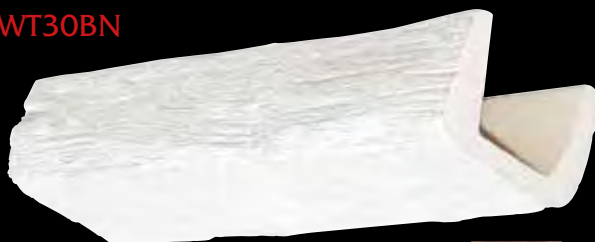

WT30 NC





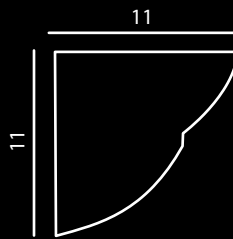

WTC106 NC

CAPITAL FOR WT6 **WTC106BN**

W9xH11xD11

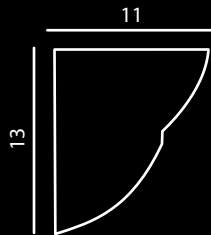

WTC111 NC

CAPITAL FOR WT11 **WTC111BN**

W11xH13xD11

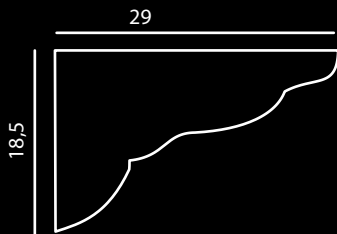
CAPITAL FOR WT13, WT15 AND WT21 **WTC126 BN**

W 17 x H 18,5 x D 29

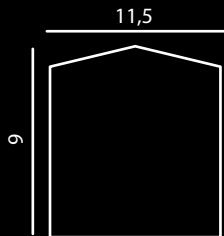

WTC126 NC

PIRAMYD FOR WT6 **WTX206 BN**

W 11,5 x H 9 x D 11,5



WTC206 NC

PYRAMID FOR BEAM T11 WTX211BN



WTX211 NC

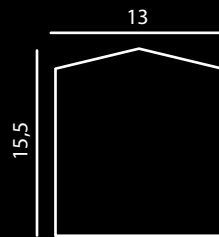

W 13 x H 11,5 x D 13

PYRAMID FOR BEAM T13, T15 WTX226



WTX226 NC

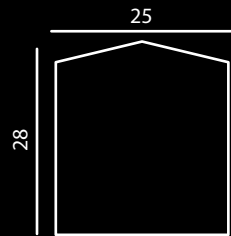

W 25 x H 28 x D 25

JOINT BAND **WTFG**

length 100 x width 1,5 cm

ANCIENT MATCHBOARD **WTL28BN**

length 200 cm



WTL28 NC



MODERN BEAMS

WTM12BN



↕ 6 cm

↔ 12 cm

WTM16BN



↕ 10 cm

↔ 16 cm

WTM10BN



↕ 10 cm

↔ 11 cm

WTM22 BN



↕ 15 cm

↔ 21,5 cm

WTLM26BN



↕ 2 cm

↔ 26 cm

WTCMP12BN



Height: 6 cm

Width: 12 cm

WTCMM16BN



Height: 10 cm

Width: 15,5 cm

WTCMP10BN



Height: 11,5 cm

Width: 15 cm

WTCMG22BN



Height: 24,5 cm

Width: 32 cm

WTAM69BN



Height: 69 cm

Width: 60 cm

WTFMP12



Height: 8 cm

Width: 22 cm

WTFMM16



↕ 12,5 cm

↔ 34 cm

WTFMG22



↕ 17,5 cm

↔ 40,5 cm

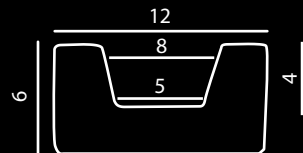

MODERN BEAM **WTM12BN**

length 300 or 450 cm



WTM12 NC



WTM12 MG

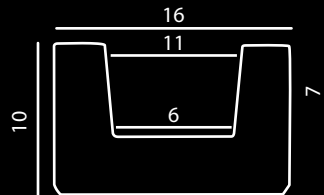

WTM12 RV

MODERN BEAM **WTM16BN**

length 300 or 450 cm



WTM16 NC



WTM16 MG



WTM16 RV

MODERN BEAM **WTM22BN**

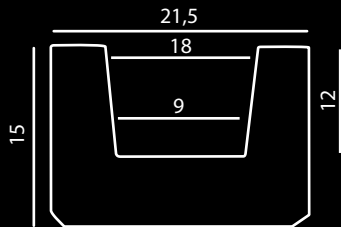

length 300 or 450 cm



WTM22 NC



WTM22 MG



WTM22 RV

MODERN BEAM **WTM10BN**

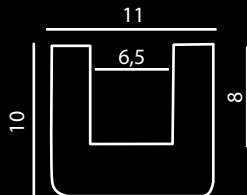

length 300 or 450 cm



WTM10 NC



WTM10 MG

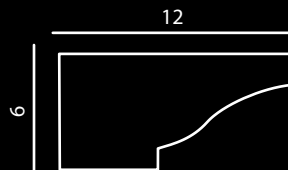

WTM10 RV

CAPITAL FOR WTM12 **WTCMP12BN**

WTCMP12 NC



WTCMP12 MG

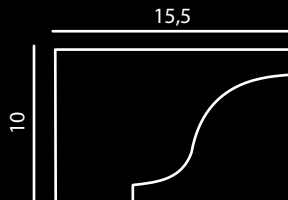
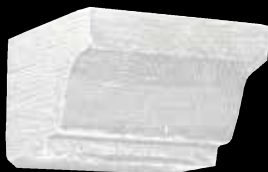

WTCMP12 RV

CAPITAL FOR WTM16 **WTCMM16BN**

WTCMM16 NC



WTCMM16 MG

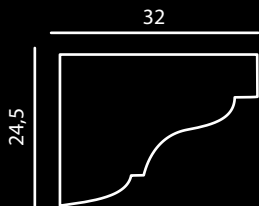

WTCMM16 RV

CAPITAL FOR WTM22 **WTCMG22BN**

WTCMG22 NC



WTCMG22 MG

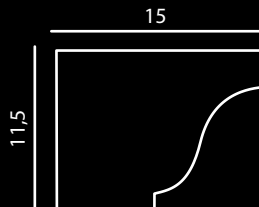

WTCMG22 RV

CAPITAL FOR WTM10 **WTCMP10BN**

WTCMP10 NC



WTCMP10 MG

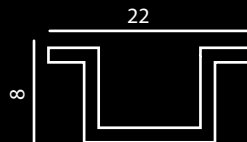

WTCMP10 RV

JOINT STRIP FOR WTM12 **WTFFMP12**

W 22,5 x H 8 x D 4,5

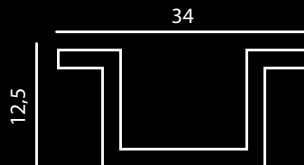
JOINT STRIP FOR WTM16 **WTFMM16**

W 34 x H 12,5 x D 7

JOINT STRIP FOR WTM22 WTFMG22

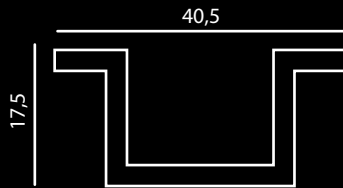

W 40,5 x H 17,5 x D 7

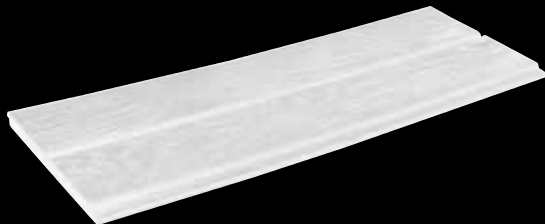

MODERN MATCHBOARD **WTLM26BN**

length 300 cm



WTLM26 NC



WTLM26 MG

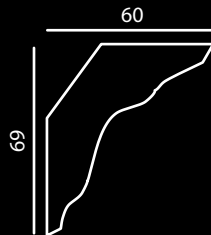

WTLM26 RV

MODERN CORNER UNIT **WTAM69BN**

H 60 x W 69 x D 8



WTAM69 NC



WTAM69 MG



WTAM69 RV



ASSEMBLING INSTRUCTIONS

We suggest to install mouldings, corners and roses before wallpapering. Items must be applied on dry clean and ungreased surfaces.

You need only the following tools: mitre-box, Bovelacci special saw, glue Eurocoll Plus, spatula, sponge, paint, brush, cutter and metre.

LE ISTRUZIONI PER IL MONTAGGIO

È preferibile posare le cornici, gli angoli ed i rosoni prima di tappezzare le pareti. I prodotti devono essere applicati su pareti asciutte, pulite e sgrassate.

Sono sufficienti i seguenti accessori: cassetta per taglio, sega speciale Bovelacci, Eurocoll Plus, spatola, spugna, pittura, pennelli, cutter e metro.

VERARBEITUNGSTIPS

Wir empfehlen die Zierprofile, Ecken, Rosetten nach Möglichkeit vor den Tapezierarbeiten zu verkleben. Der Untergrund muss saugfähig, sauber, trocken und staubfrei sein.

Folgende Werkzeuge werden benötigt: Gehrungslade, Bovelacci-Spezialsäge, Eurocoll Plus-Klebstoff, Spachtel, Schwamm, Farbe, Pinsel, Cuttermesser und ein Zollstock.

ИНСТРУКЦИЯ ПО МОНТАЖУ

Мы рекомендуем сначала приклеить плинтус и розетки перед отделкой стен. Стена должна быть сухой, чистой и обезжиренной.

Достаточно иметь следующие инструменты: стусло для резки, ножовка, клей Eurocoll Plus, шпаклёвка, губка, краска, кисточки, нож и метр.





MITRE-BOX

Dim. int. 16 x 20 x L. 50 cm

LA CASSETTA PER TAGLIO

Dim. int. 16 x 20 x L. 50 cm

GEHRUNGSLADE

Dim. int. 16 x 20 x L. 50 cm

СТУСЛО ДЛЯ РЕЗКИ

Внут. Раз. 16 x 20 x Длина 50 см



SPECIAL SAW L. 50 cm

LA SEGA SPECIALE - L. 50 cm

SPEZIALSÄGE L. 50 cm

НОЖОВКА СПЕЦИАЛЬНАЯ Длина 50 см



gr. 450

Kg. 7

Kg. 1,8

GLUE: EUROCOLL PLUS

Special adhesive for polystyrene, polyurethane and "polistrutturato" white paste (average incidence: 1 cart. x 8 lm)

Application temperature: $+8^{\circ}\text{C} \div +30^{\circ}\text{C}$

Temperature stability $+0^{\circ}\text{C} \div +55^{\circ}\text{C}$

Shelf life: 10 months - Keep away from chill

Let dry for a week, before filling up the joints with Eurocoll Plus and finishing with water-based paint. Testing glue before applying is recommended.

IL COLLANTE: EUROCOLL PLUS

Collante speciale per polistirene, poliuretano e polistrutturato in pasta bianca (incidenza media: 1 cart. x 8 ml)

Temperatura di applicazione: +8 °C ÷ +30 °C

Temperatura d'impiego ad essiccazione avvenuta: +0 °C ÷ +55 °C

Conservazione: 10 mesi - Teme il gelo

Lasciare asciugare per una settimana, poi stuccare con Eurocoll Plus e rifinire con una vernice a base d'acqua.

Prima del montaggio si consiglia di testare la colla sul sottofondo.

GLUE: EUROCOLL PLUS

Spezial-Klebstoff für Polystyrol, Polyurethan und Polistrutturato weiss, pastös (durchschnittlicher Verbrauch: 1 Kart. x 8 ml)

Verarbeitungstemperatur: +8 °C ÷ +30 °C

Temperaturbeständigkeit: +0 °C ÷ +55 °C

Lagerstabilität: 10 Monate

Nach einer Trocknungszeit von einer Woche können die Fügen mit Eurocoll Plus gefüllt werden und mit Dispersionsfarbe oder Acryllack überstrichen werden Vor der Montage testen Sie bitte mit einem kl. Musterstück die Festigkeit des Klebers auf dem Untergrund.

КЛЕИ: EUROCOLL PLUS

Белый специальный пастообразный клей (средний расход: 1 туба / 8 мл)

Температура применения: +8 / +30 °C

Температура использования: +0 / +55 °C

Срок хранения: 10 месяцев - Хранить подальше от детей

Заполнить клеем Eurocoll Plus все стыки и пространства через неделю. Когда всё высохнет, подправить краской на водной основе Перед работой с клеем ознакомьтесь с инструкцией.



1



2

1. Cut straight ends to make the type of corners you need. Check that they fit.
 2. Apply the special glue Eurocoll Plus on both back surfaces of the stick meant to lean on the wall and inside the joint (average incidence: 1 cart. x 8 lm).
1. Iniziare a tagliare le cornici in modo da realizzare gli angoli che vi servono. Controllate che combino.
 2. Stendere la colla speciale Eurocoll Plus su entrambe le superfici posteriori dell'asta che andranno a contatto con la parete o il soffitto, nonchè fra le giunture (incidenza media: 1 cart. x 8 ml).
1. Beim Schneiden der Gehrung ist unbedingt darauf zu achten, dass die "Deckenklebefläche" des Zierprofils auf dem Boden und die "Wandklebefläche" an der Innenwand der Gehrungslade liegt.
 2. Nachdem die Gehrung auf Passgenauigkeit geprüft wurde, wird der Klebstoff Eurocoll Plus auf beide Klebeflächen und im Stoßbereich mit der Kartusche oder mit dem Spachtel aufgetragen (durchschnittlicher Verbrauch: 1 Kart. x 8 ml).
1. Начните резать плинтус так, что бы создать необходимые углы.
 2. Нанесите специальный клей Eurocoll Plus на внутреннюю часть плинтусов, которые будут сопри-касаться со стеной или потолком (средний расход: 1 туба / 8 пм).



3



4

3. Press pieces into the corner with a light pressure. After a week fill all joints and gaps with glue.

4. Remove glue in excess by using a spatula.

3. Applicare la cornice alla parete con una leggera pressione. Dopo una settimana riempite con la colla ogni giuntura o spazio.

4. Togliete l'eccesso di colla con l'aiuto di una spatola.

3. Das Zierprofil passgenau ansetzen und vorsichtig andrücken. Nach einer Woche alle Fugen und Stöße mit Klebstoff füllen. 4. Überschüssigen Klebstoff mit einem Spachtel sofort entfernen.

3. Приклейте плинтус к стене, слегка надавливая на него. Через неделю заполните клеем Eucosoll все стыки и про- странства.

4. Удалите излишки клея с помощью шпателя.



5. Wipe smooth with a clean damp sponge.
6. Let dry and apply water-based paint.

5. Pulite quindi con l'aiuto di una spugna.
6. Lasciate asciugare e rifinite con vernice a base d'acqua.

5. Anschließend Klebstoffreste mit einem feuchten Schwamm sofort abwaschen.
6. Die Zierprofile können nach einer Trocknungszeit von ca. 24 Std. mit Dispersionsfarbe oder Acryllack überstrichen werden.

5. Очистить поверхность чистой влажной губкой.
6. Дать время для про-сушивания поверхности, а затем подправить краской на водной основе.







1



2

1. Make a central hole in the middle of the ceiling centre by using a cutter.
2. Apply the special Eurocoll Plus glue around the circumference.

1. Praticare col cutter un foro centrale nel rosone se è prevista l'applicazione di un lampadario.
2. Applicare la speciale colla Eurocoll Plus lungo la circonferenza.

1. Um eine Öffnung für ein Lampenkabel zu erhalten, wird die passende Größe mit einem Cutter herausgeschnitten.
2. Ausreichend Eurocoll Plus-Kleber am Rand der Rosette auftragen.

1. В центре розетки проделать отверстие с помощью ножа.
2. Нанести клей Eurocoll Plus вдоль окружности.



3. Lean the ceiling centre on the ceiling.
To fill all gaps use Eurocoll Plus glue.
Apply water-based paint.
3. Appoggiare il rosone al soffitto nel punto desiderato. Per stuccare usare Eurocoll Plus. Verniciare con idropittura.
3. Die Rosette passgenau ansetzen und vorsichtig andrücken. Fugen mit Eurocoll Plus-kleber füllen. Nach ausreichender Trocknung des Klebers kann die Rosette gestrichen werden.
3. Приложить розетку к потолку в желаемом месте, используя краску на водной основе. Для заполнения использовать клеем Eurocoll Plus.

BRICKSTYL

Examine your ceiling to be sure that it is clean and free from any grease. Verify the painted surface and if necessary apply a primer.

Cut straight ends to make the type of corners you need, checking that they match.

Apply a special acrylic and cement-based glue for external covering on the hind surfaces of the staff and on the joints.

Press the moulding to the wall with a light pressure. Use also expanding stoppers. Let it dry.

After a week fill all the joints or gaps with BST2 Bovelacci stucco (average incidence of stucco for mouldings: 1kg x 20 lm).

Remove the stucco in excess by using a damp sponge. Let it dry and finish off with a good elastic water-based or acrylic paint for exterior.

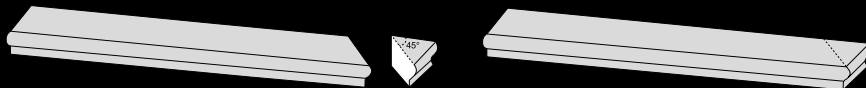

BRICKSTYL

Assicurarsi che il muro sia pulito e senza tracce di grassi.

Verificare la tenuta della pittura ed eventualmente applicare uno strato di fissativo.

Tagliare le cornici in modo da realizzare gli angoli che vi servono, verificando che combinino.

Applicare una colla speciale acrilica a base cementizia per rivestimenti esterni lungo le superfici posteriori dell'asta e sulle giunture. Mediante una leggera pressione applicare la cornice alla parete. Utilizzare anche tappi ad espansione. Lasciare asciugare.

Dopo una settimana riempire ogni giuntura o spazio con stucco Bovelacci tipo BST2 (incidenza media stucco per le cornici: 1kg. x 20 ml).

Rimuovere quindi lo stucco in eccesso con una spugna bagnata.

Lasciare asciugare e rifinire con una buona pittura elastica a base d'acqua od acrilica per esterno.

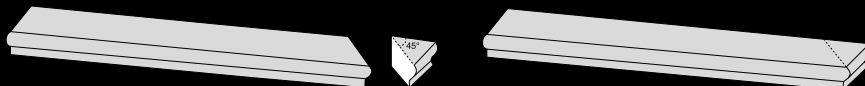

BRICKSTYL

Prüfen Sie ob die Wand sauber und frei von Öl, Fett und Lacken ist. Prüfen Sie die Tragfähigkeit der Farbe und tragen Sie ggf. eine Schicht Tiefengrund auf. Zierleisten auf die benötigte Gehrung zuschneiden und diese auf Passgenauigkeit prüfen. Einen speziellen Acrylklebstoff auf Zementbasis für Außenverkleidungen auf die Rückseite und im Stossbereich der Leiste auftragen. Das Zierprofil passgenau an die Wand ansetzen und vorsichtig andrücken. Zur zusätzlichen Befestigung können auch Spreizdübel verwendet werden. Trocknen lassen und nach einer Woche alle Fugen und Stöße mit Bovelacci-Kitt BST2 füllen (durchschnittlicher Verbrauch für die Zierleisten: 1 kg. x 20 lfm). Überschüssigen Kitt mit einem feuchten Schwamm entfernen. Nach ausreichender Trocknung der Kitts mit einer guten elastischen Farbe auf Wasser- oder Acrylbasis für den Außenbereich überstreichen.

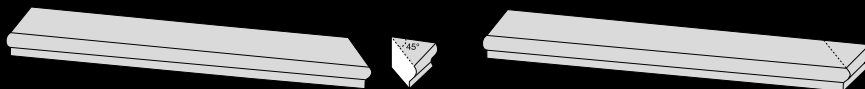

BRICKSTYL

Мы рекомендуем сначала приклеить плинтусы перед отделкой стен. Стена должна быть сухой, чистой и обезжиренной.

Начните резать рейки так, что бы создать необходимые углы.

Нанесите специальный клей для наружных работ на внутреннюю часть плинтусов, которые будут соприкасаться со стеной или потолком.

Приклейте плинтус к стене, слегка надавливая на неё.

Через неделю заполните клеем BST2 STUCCO (Средний расход:

1 кг на 20 пм) все стыки и пространства.

Удалите излишки клея с помощью шпателя.

Очистить поверхность чистой влажной губкой.

Дать время для просушивания поверхности, а затем под.

Править краской на водной основе.

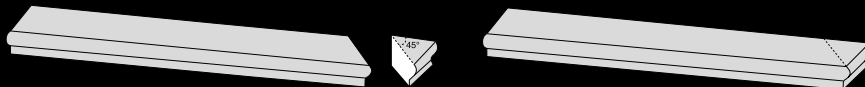

WOODSTYL

1. Use the nogs.

2. Pierce and fix the nogs to the ceiling.

3. Use one nog each meter.

1. Einsatzstücke benutzen.

2. Die Einsatzstück mit Dübeln und Schrauben unter der Decke befestigen.

3. Je meter ein Einsatzstück verwenden.

1



2

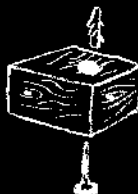

3



1. Utilizzare i tasselli.

2. Forare e fissare al soffitto i tasselli.

3. Utilizzare un tassello ogni metro.

1. Используйте клинышками.

2. Продевание и фиксация клинышков на потолке.

3. Используйте древесный клинышек каждый метр.

4. Fix the beam with nails, after glueing the contact surfaces of the beam with the ceiling.

4. Den Balken mit Nägeln fixieren.

5. Zierbeschlag befestigen.

4

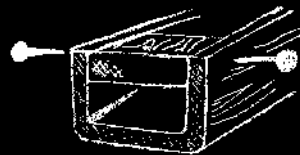

5. Use iron-like joint strip.

5



4. Fissare la trave con viti dopo aver steso Eurocoll Plus nelle zone di contatto della trave con il soffitto.

4. Фиксация балок при помощи гвоздей.

5. Прикрыть стыки, используя накладку с заклёпками.

5. Usare la fascia chiodata per le giunture.







covings, ceiling centers and
decors of polystrene

and more...

decor and insulating ceiling tiles

wall insulations

hobby and crafts

packaging



BOVELACCI

Forlì - Italy

www.bovelaccidecor.com

