

Stefano Orlati



Stefano Orlati

Welcome to Stefano Orlati proud member of the Titus Group...

Combining the Titus Plus innovation, technical expertise and reliability with established design and service from Stefano Orlati

The Stefano Orlati brand has established an unparalleled presence in the market for over 15 years.

Emphasis has been placed on providing a comprehensive range of high quality designer cabinet handles, LED lighting and general hardware which encompass inspirations for your vision and innovative solutions.

Alongside the Stefano Orlati brand mark is the Titus logo. The Titus group (Titus International Ltd.) is a group of companies that develops, manufactures and markets innovative small components solutions such as: furniture hardware, hydraulic dampers, automated assembly systems, production tools and die-casting technology.

Stefano Orlati has been a valued distributor of Titus making it a natural progression to amalgamate in 2015 and thus offering an extended product range for the cabinetmaking, furniture manufacturing and distribution industries in Australia and New Zealand.

Stefano Orlati handles design with service and aims to go above and beyond to provide exceptional service and supply and continues to be market leaders in their field.

www.titustekform.com.au | www.stefanohardware.com

Conditions Of Sale

Whilst every care is given to dimension and other details in this catalogue, Stefano Orlati cannot be held liable for any errors which might be shown in this catalogue. Stefano Orlati reserves the right to alter or amend technical specifications at any time.



CABINET HANDLES

Bow Handles	05
Profile Handles	17
Provincial Handles	21
Recessed Handles	25
Square Handles.....	29
Stainless Steel Handles	43

CABINET KNOBS











All Knobs	47
-----------------	----











PRODUCT CODE INDEX

Product Code Index	57
--------------------------	----

COLOUR FINISH GUIDE

Please note: Colour finish guide is an indicative only - actual finish may vary

AB		Antique Bronze
ABS		Aluminium Brushed Satin
AC		Antique Copper
BLKN		Black Nickel
BN		Brushed Nickel
BSAT		Brushed Satin Antique Tin
BSBN		Brushed Satin Black Nickel
CH		Chrome
CL		Clear Glass
FS		Foggy Silver
MB		Matt Black

MBN		Matt Brushed Nickel
MC		Matt Chrome
P		Pewter
S		Silver
SMK		Smoked Glass
SN		Satin Nickel
SS		Stainless Steel
T		Tungsten
TG		Titanium Grey
WH		White
WHC		White Crackled Finish

ORDER GUIDE

All handles & knobs are supplied with a set of screws to suit. When ordering handles or knobs please use the following code string-

	Handle Code	Centre Size	Finish
 Example	1037	128mm	BN

GUIDE TO HANDLE DIMENSIONS

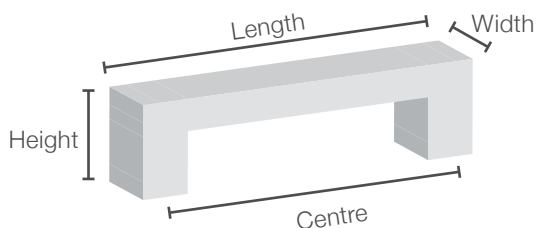

Length: Overall length of the handle(mm)

Centre: Screw hole to screw hole(mm)

Height: Height/Projection of handle(mm)

Width: Width of handle face(mm)

Online Ordering is available to all our customers who have active trade accounts - contact Stefano Orlati for more information or register online www.stefanohardware.com

Stefano Orlati  Titus



BOW HANDLES >

1037



BN



CH



MC



Centre (mm)	Length (mm)	Height (mm)	Width (mm)
128	158	29	10

1062

 While Stocks Last



BN



MC



Centre (mm)	Length (mm)	Height (mm)	Width (mm)
96	143	24	14
128	183	26	16

112



BN



MC



Centre (mm)	Length (mm)	Height (mm)	Width (mm)
128	170	27	24

114

BN
 MC



Centre (mm)	Length (mm)	Height (mm)	Width (mm)
160	185	27	24

122

BN
 MC



Centre (mm)	Length (mm)	Height (mm)	Width (mm)
160	180	26	18

2050

BN



Centre (mm)	Length (mm)	Height (mm)	Width (mm)
128	162	30	16

2051



BN



MC



Centre (mm)	Length (mm)	Height (mm)	Width (mm)
128	160	31	16

2053



BN



MC



Centre (mm)	Length (mm)	Height (mm)	Width (mm)
128	158	30	17

2060



BN



MC



Centre (mm)	Length (mm)	Height (mm)	Width (mm)
96	115	28	10
128	154	30	10

211XL



Also available - see page 15



Centre (mm)	Length (mm)	Height (mm)	Width (mm)
224	270	31	14

2188



Centre (mm)	Length (mm)	Height (mm)	Width (mm)
96	121	29	20

3047



Centre (mm)	Length (mm)	Height (mm)	Width (mm)
128	200	27	12
160	240	27	12

3062



BN



MC



Centre (mm)	Length (mm)	Height (mm)	Width (mm)
160	222	28	26

311



BN



MC



Centre (mm)	Length (mm)	Height (mm)	Width (mm)
128	165	31	16

3130



BN



CH



MB



WH



Centre (mm)	Length (mm)	Height (mm)	Width (mm)
128	147	30	18
192	222	30	18
256	275	30	18
416	430	30	18

325

+ NEW PRODUCT



CH



SN

Centre (mm)	Length (mm)	Height (mm)	Width (mm)
128	168	29	12
160	200	29	12
224	264	30	12
320	360	30	12

3319



BN



MC

Centre (mm)	Length (mm)	Height (mm)	Width (mm)
96	140	22	15
192	250	22	15

3380



BN



T

Centre (mm)	Length (mm)	Height (mm)	Width (mm)
128	151	28	25
160	189	28	25
224	260	33	25
320	330	33	25
416	463	38	25

6329



Centre (mm)	Length (mm)	Height (mm)	Width (mm)
128	167	26	22
192	231	26	22
256	295	26	22
320	359	27	22

688



Centre (mm)	Length (mm)	Height (mm)	Width (mm)
96	124	12	26

7025



Centre (mm)	Length (mm)	Height (mm)	Width (mm)
128	138	25	20
160	170	28	20
224	234	28	20
320	330	28	20

9238



SN



Centre (mm)	Length (mm)	Height (mm)	Width (mm)
96	118	25	12

9718



BN



MC



Centre (mm)	Length (mm)	Height (mm)	Width (mm)
96	141	30	9
128	200	30	12

9908



BN



CH



MC



Centre (mm)	Length (mm)	Height (mm)	Width (mm)
96	105	30	13
128	147	30	14

9910



BN



MC



Centre (mm)	Length (mm)	Height (mm)	Width (mm)
96	114	21	10
128	150	27	12

ARC



BN



Centre (mm)	Length (mm)	Height (mm)	Width (mm)
128	153	31	10
160	190	31	10
224	263	31	10
288	336	31	10

C



BN



FS



MB



Centre (mm)	Length (mm)	Height (mm)	Width (mm)
128	148	26	10
160	180	26	10
192	212	26	10

MJ001

 While Stocks Last



Centre (mm)	Length (mm)	Height (mm)	Width (mm)
64	84	21	15

TSB



*Matt Black finish is only available in 96mm

 Also available-
see page 9



Centre (mm)	Length (mm)	Height (mm)	Width (mm)
96*	111	29	10
128	150	30	10



Product #3130 / page 10

Stefano Orlati 



PROFILE HANDLES >

AK0891

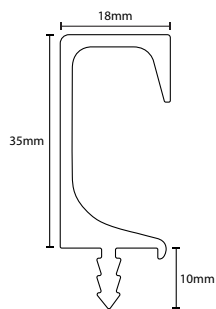

Side Profile

Length (mm)	Height (mm)	Width (mm)
3000	35	18

AK0891B

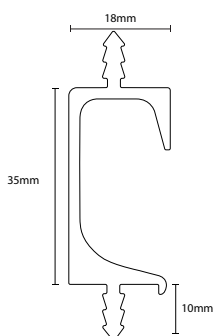

Side Profile

Length (mm)	Height (mm)	Width (mm)
3000	35	18

AK0894

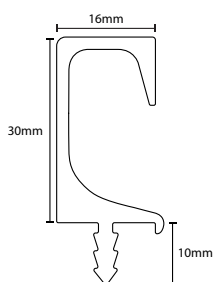

Side Profile

Length (mm)	Height (mm)	Width (mm)
3000	30	16

CAPRI-C



FS



TG

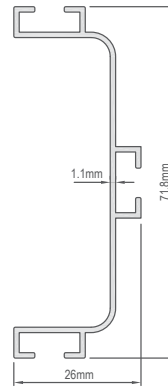

Side Profile



End Cap
CAPRI-C-EC



BRACKET
CAPRI-B

Length (mm)	Height (mm)	Width (mm)
3600	71.8	26

CAPRI-J



FS



TG

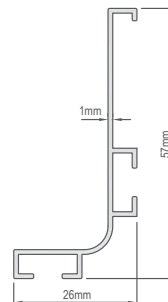

Side Profile



End Cap
CAPRI-J-EC



BRACKET
CAPRI-B

Length (mm)	Height (mm)	Width (mm)
3600	57	26

PESARO PULL

ABS

Mounts on top of edge panel

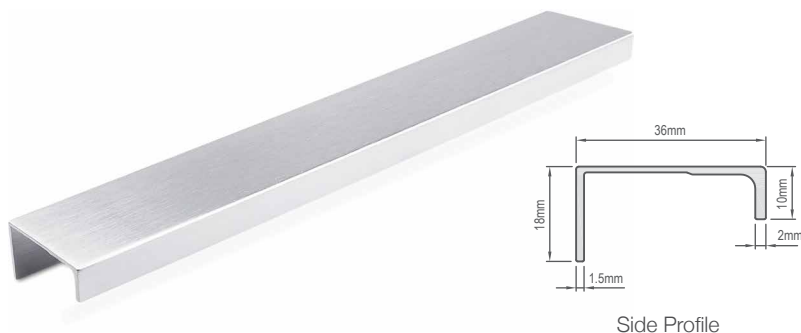

Length (mm)	Height (mm)	Width (mm)	Screw Holes
200	18	36	2 screw holes- 40mm from edge
400	18	36	3 screw holes- 100mm between each hole & edge
600	18	36	4 screw holes- 120mm between each hole & edge
1250	18	36	Without holes drilled

R156

ABS FS

Mounts on top of edge panel

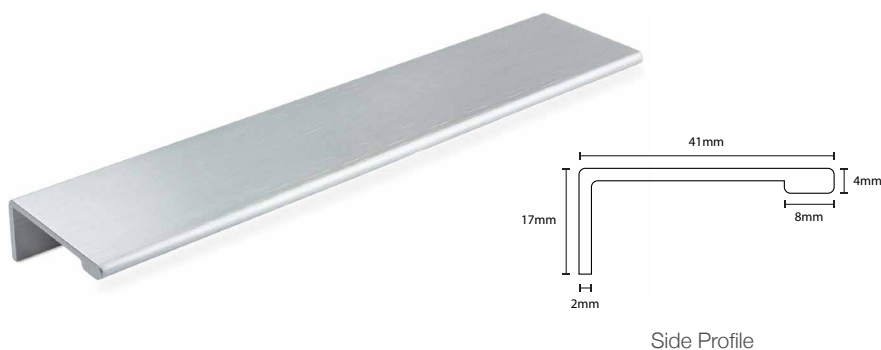

Centre (mm)	Length (mm)	Width (mm)
64	90	41
160	190	41

Stefano Orlati  Titus



PROVINCIAL HANDLES >

1186



BSAT



BSBN



Also available-
see page 49 & 22



Centre (mm)	Length (mm)	Height (mm)	Width (mm)
96	132	29	14
160	204	29	16

1208



BSAT



BSBN



Also available-
see page 49 & 22



Centre (mm)	Length (mm)	Height (mm)	Width (mm)
96	135	31	34

3440



NEW PRODUCT



BN



BSBN



Also available-
see page 51



Centre (mm)	Length (mm)	Height (mm)	Width (mm)
128	150	33	18
160	182	33	18
224	246	33	18
320	342	33	18

8391



Also available - see page 51, 52 & 23



Centre (mm)	Length (mm)	Height (mm)	Width (mm)
160	180	32	40

8392



Also available - see page 51, 52 & 23



Centre (mm)	Length (mm)	Height (mm)	Width (mm)
128	188	28	21

8407



Also available - see page 53 & 24



Centre (mm)	Length (mm)	Height (mm)	Width (mm)
64	90	23	34

8658



AB



BN



CH



Also available - see page 53 & 23



Centre (mm)	Length (mm)	Height (mm)	Width (mm)
96	132	25	16

C15



WHC/P
Combined finish



Also available - see page 54



Centre (mm)	Length (mm)	Height (mm)	Width (mm)
128	150	40	23



Product #8391 / page 23

Stefano Orlati  **Titus** 



RECESSED HANDLES >

1159

BN



Centre (mm) Hole Diameter	Height / Hole Depth (mm)	Width / Recess Mounted Face Plate (mm)
35	7	40

6316

FS

- Suit minimum 16mm board
- Recess depth 14mm

 While Stocks Last



Centre (mm)	Length (mm)	Height (mm)	Width (mm)
192	260	17	62
320	410	17	62

709

S

- Suit minimum 16mm board
- Recess depth 10mm



Centre (mm)	Length (mm)	Height (mm)	Width (mm)
128	138	13	30

8457



- Suit minimum 16mm board
- Recess depth 9mm

 While Stocks Last



Centre (mm)	Length (mm)	Height (mm)	Width (mm)
96	127	13	36

AHS403



- Suit minimum 16mm board
- Recess depth 14mm

Note: ABS in this range is a dark version of the Aluminium Brushed Satin finishes



Centre (mm)	Length (mm)	Height (mm)	Width (mm)
128	145	16	42
160	172	16	42

MH20



- Suit minimum 18mm board
- Recess depth 15mm



Centre (mm)	Length (mm)	Height (mm)	Width (mm)
127	170	18	40
226	330	18	40



Product #AHS403 / page 27

Stefano Orlati  Titus



SQUARE HANDLES >

1092



BN



CH



MC



Centre (mm)	Length (mm)	Height (mm)	Width (mm)
96	102	27	11
128	134	27	11
160	166	27	11
224	230	27	11
288	294	27	11
320	326	27	11

113



BN



MC



Centre (mm)	Length (mm)	Height (mm)	Width (mm)
160	179	26	27

116



BN



MC



Centre (mm)	Length (mm)	Height (mm)	Width (mm)
128	159	29	15
160	190	29	15

1745



BN



MC



Centre (mm)	Length (mm)	Height (mm)	Width (mm)
128	137	28	21
192	201	28	21
256	265	28	21

1759



BN



CH



FS



Centre (mm)	Length (mm)	Height (mm)	Width (mm)
96	115	38	15
128	148	38	15
192	210	38	15
224	245	38	15
320	339	38	15
480	499	38	15
544	563	38	15
736	755	38	15

202

While Stocks Last



BN



CH



FS



Centre (mm)	Length (mm)	Height (mm)	Width (mm)
32	56	21	55
96	160	21	55

216

FS



Centre (mm)	Length (mm)	Height (mm)	Width (mm)
256	295	28	12
320	370	28	12

242

BN CH FS

 While Stocks Last



Centre (mm)	Length (mm)	Height (mm)	Width (mm)
32	75	21	74

245

ABS FS

 While Stocks Last

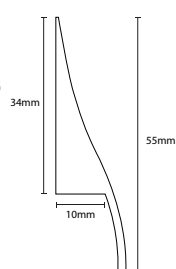

Side Profile

Centre (mm)	Length (mm)	Height (mm)	Width (mm)
128	150	18	57
224	270	18	57
352	390	18	57

255

 **BN**



Centre (mm)	Length (mm)	Height (mm)	Width (mm)
128	145	30	11.5
192	210	30	11.5
544	560	30	11.5
608	625	30	11.5

274

 **CH**  **FS**

*Chrome finish is only available in 96mm

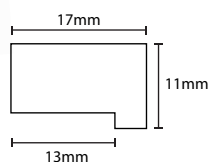

Side Profile

Centre (mm)	Length (mm)	Height (mm)	Width (mm)
96*	120	17	11
128	150	17	11
192	245	17	11
288	330	17	11
576	628	17	11
864	914	17	11

276

 **CH**  **FS**

*Chrome finish is only available in 96mm



Side Profile

Centre (mm)	Length (mm)	Height (mm)	Width (mm)
64	98	20	10
96*	120	20	10
128	150	20	10
192	245	20	10
288	330	20	10

288



*FS available in all sizes & BN available up to 650mm only

Centre (mm)	Length (mm)	Height (mm)	Width (mm)
16	80	36	16
96	109	36	16
128	141	36	16
160	173	36	16
224	237	36	16
288	301	36	16
448	461	36	16
544	557	36	16
650	663	36	16
736*	749	36	16

298



Centre (mm)	Length (mm)	Height (mm)	Width (mm)
64	78	32	15
128	142	32	15
256	270	32	15

305

+ NEW PRODUCT



Centre (mm)	Length (mm)	Height (mm)	Width (mm)
128	145	25	12
160	177	25	12
224	241	27	12
320	337	27	12

3061



BN



MC



Centre (mm)	Length (mm)	Height (mm)	Width (mm)
128	158	25	20
192	226	27	24

3064



BN



MC



Centre (mm)	Length (mm)	Height (mm)	Width (mm)
96	121	27	8
128	157	27	8
160	192	27	8
192	224	27	8
240	273	27	8
320	355	27	8

508



SN



Centre (mm)	Length (mm)	Height (mm)	Width (mm)
96	127	20	16

548



ABS



MB



Centre (mm)	Length (mm)	Height (mm)	Width (mm)
128	170	26	17
192	235	26	17
320	362	26	17
544	588	26	17
608	650	26	17
736	775	26	17

6002



AB



MC

Note: AB finish in this range is a dark Antique Bronze

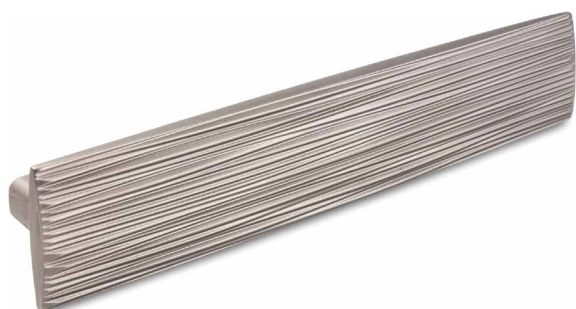

Also available - see page 52



Centre (mm)	Length (mm)	Height (mm)	Width (mm)
96	114	31	36
160	178	31	36

6330



BN



FS



Centre (mm)	Length (mm)	Height (mm)	Width (mm)
128	142	30	25
192	206	30	25
256	269	30	25
320	334	30	25
544	558	30	25

690



CH



MC



Centre (mm)	Length (mm)	Height (mm)	Width (mm)
64	83	18	11

809



BN



CH



MC

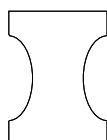

Side Profile

Also available - see page 52



Centre (mm)	Length (mm)	Height (mm)	Width (mm)
96	108	18	12
160	178	18	12
256	274	20	12

8230



ABS

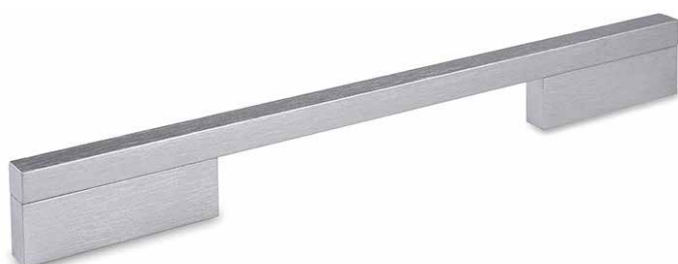

Centre (mm)	Length (mm)	Height (mm)	Width (mm)
128	192	30	10
192	256	30	10
320	384	30	10
480	544	30	10

843



AC



CH

 Also available - see page 53



Centre (mm)	Length (mm)	Height (mm)	Width (mm)
128	174	27	26
192	238	27	26

8645



ABS



CH



FS

Centre (mm)	Length (mm)	Height (mm)	Width (mm)
160	250	30	7

8650



ABS



CH



FS

Centre (mm)	Length (mm)	Height (mm)	Width (mm)
160	250	30	7

A



BN



FS



MB



Centre (mm)	Length (mm)	Height (mm)	Width (mm)
128	135	30	12
160	167	30	12
224	231	30	12
320	327	30	12

B



BN



FS



MB



Centre (mm)	Length (mm)	Height (mm)	Width (mm)
128	135	30	16
160	167	30	16
224	231	30	16
320	327	30	16

D



BN



MC

*Brushed Nickel finish is only available in 96mm



Centre (mm)	Length (mm)	Height (mm)	Width (mm)
96*	106	37	10
128	138	37	10

GL01



CL/CH
With chrome feet



SMK/CH
With chrome feet

Centre (mm)	Length (mm)	Height (mm)	Width (mm)
128	143	30	35
192	207	30	35
256	271	30	35
320	335	30	35

IN2



CH

Centre (mm)	Length (mm)	Height (mm)	Width (mm)
90	108	30	8

MH14



BN



CH



S

Centre (mm)	Length (mm)	Height (mm)	Width (mm)
64	78	29	7
96	110	29	7
128	141	29	7
224	238	29	7
320	333	29	7

OK90



Centre (mm)	Length (mm)	Height (mm)	Width (mm)
128	149	24	7

T905



Note: AB finish in this range is a dark Gold Antique Bronze finish

 Also available - see page 55



Centre (mm)	Length (mm)	Height (mm)	Width (mm)
128	150	20	40
192	214	20	40

TB



Centre (mm)	Length (mm)	Height (mm)	Width (mm)
96	154	28	10

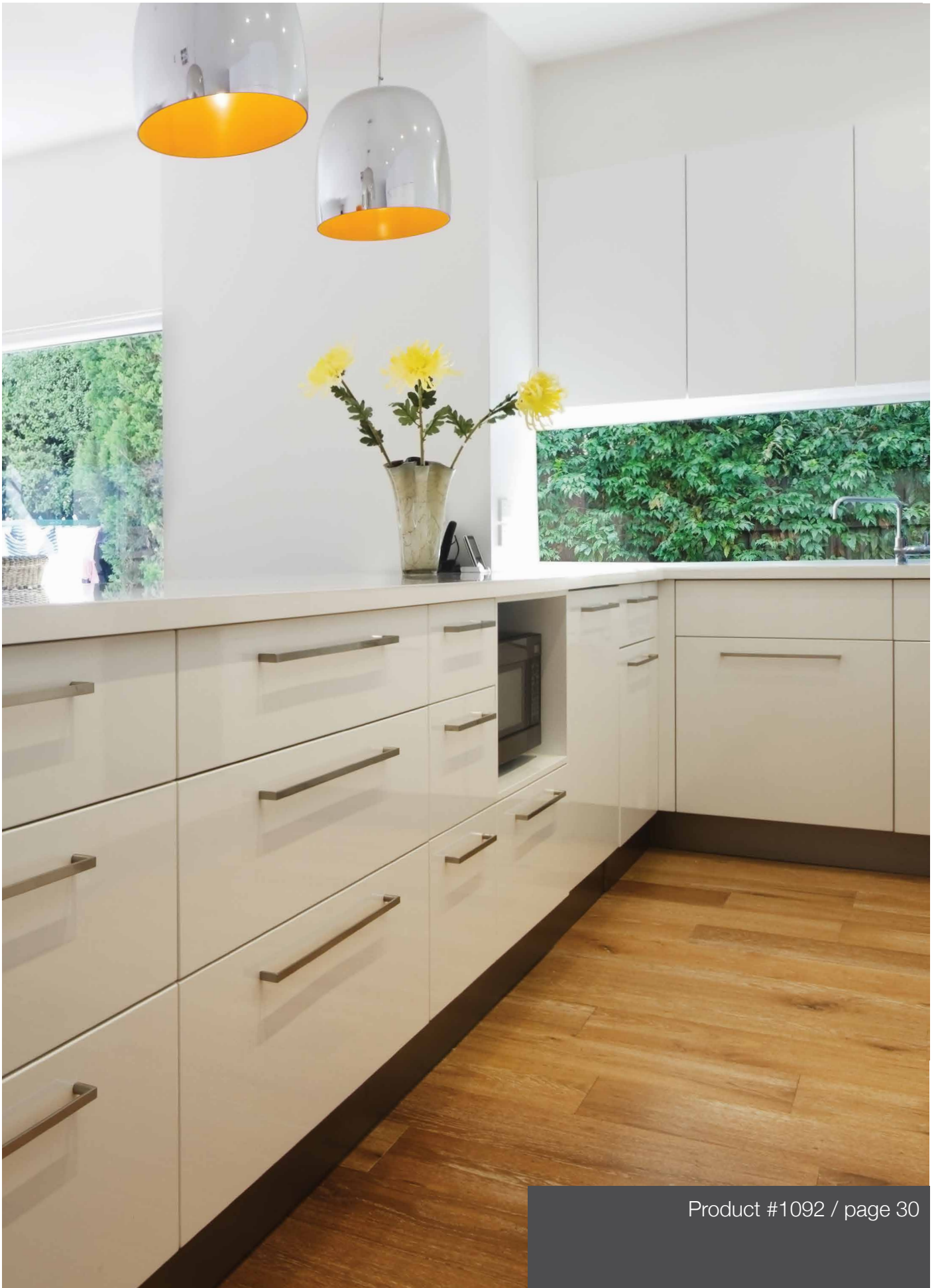

Product #1092 / page 30

Stefano Orlati  Titus



STAINLESS STEEL HANDLES >

6820

SS



Centre (mm)	Length (mm)	Height (mm)	Width (mm)
128	136	31	21
160	168	31	21
224	232	31	21
320	328	31	21
448	456	31	21

8513

SS



Centre (mm)	Length (mm)	Height (mm)	Width (mm)
128	150	40	13
160	182	40	13
192	214	40	13
224	246	40	13
352	374	40	13
554	576	40	13
576	598	40	13
832	854	40	13

8721

SS



Centre (mm)	Length (mm)	Height (mm)	Width (mm)
128	138	33	19
160	170	33	19
192	202	33	19
224	234	33	19
320	330	33	19
448	458	33	19
554	564	33	19

909



Centre (mm)	Length (mm)	Height (mm)	Width (mm)
128	142	40	14
160	174	40	14
224	238	40	14
320	334	40	14
480	494	40	14

SSD



Centre (mm)	Length (mm)	Height (mm)	Width (mm)
128	138	33	10
160	170	33	10
192	202	33	10
288	298	33	10
352	362	33	10
448	458	33	10

SSTB



Centre (mm)	Length (mm)	Height (mm)	Width (mm)
96	136	34	12
128	168	34	12
160	200	34	12
192	232	34	12
288	328	34	12
352	392	34	12
448	488	34	12
544	584	34	12
736	776	34	12
960	1000	34	12



Product #909 / page 45

Stefano Orlati  Titus



CABINET KNOBS >

1112



Centre (mm)	Length (mm)	Height (mm)	Width (mm)
16	25	27	21

1160

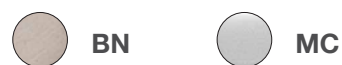

Code	Centre (mm)	Height (mm)	Width (mm)
Small- 1160S	Single Fixing	26	17
Large- 1160L	Single Fixing	28	25

1172



Centre (mm)	Height (mm)	Width (mm)
Single Fixing	19	14

1173



Centre (mm)	Length (mm)	Height (mm)	Width (mm)
16	42	19	14

1179



BN



MC

Centre (mm)	Height (mm)	Width (mm)
Single Fixing	28	22

1186K



BSAT



BSBN

Also available - see page 22



Centre (mm)	Length (mm)	Height (mm)	Width (mm)
Single Fixing	38	25	19

139



BN



CH



MC

Centre (mm)	Height (mm)	Width (mm)
Single Fixing	27	29

288K



BN



CH



FS

Also available - see page 34



Centre (mm)	Length (mm)	Height (mm)	Width (mm)
16	80	36	16

3318



Centre (mm)	Length (mm)	Height (mm)	Width (mm)
16	39	18	21

3320



Centre (mm)	Height (mm)	Width (mm)
Single Fixing	28	33

3321



Centre (mm)	Height (mm)	Width (mm)
Single Fixing	26	27

3322

 While Stocks Last



Centre (mm)	Height (mm)	Width (mm)
Single Fixing	26	12

3323

 While Stocks Last



CH

Centre (mm)	Length (mm)	Height (mm)
16	32	30

3440K

 NEW PRODUCT



BN



BSBN

 Also available-see page 22



Centre (mm)	Length (mm)	Height (mm)	Width (mm)
Single Fixing	21	33	18

3590



FS

Centre (mm)	Height (mm)	Width (mm)
Single Fixing	24	15

3801



AB



BN



P

 Also available-see page 52, 23



Centre (mm)	Length (mm)	Height (mm)	Width (mm)
Single Fixing	33	25	33

6002K



Also available - see page 36



Centre (mm)	Length (mm)	Height (mm)	Width (mm)
32	50	31	36

8047



Centre (mm)	Length (mm)	Height (mm)	Width (mm)
Single Fixing	38	31	38

809K

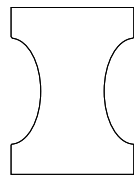

Side Profile



Also available - see page 37



Centre (mm)	Length (mm)	Height (mm)	Width (mm)
16	28	18	12

8393



Also available - see page 51, 23



Centre (mm)	Length (mm)	Height (mm)	Width (mm)
Single Fixing	64	32	22

843K



AC



CH

Also available - see page 38



Centre (mm)	Length (mm)	Height (mm)	Width (mm)
Single Fixing	35	22	35
16	54	22	54

8741



AB



BN



CH

Also available - see page 23 & 24



Centre (mm)	Length (mm)	Height (mm)	Width (mm)
Single Fixing	33	28	33

929-1



CH



S

Centre (mm)	Length (mm)	Height (mm)	Width (mm)
Single Fixing	26	20	17

9909



AB



MB

Centre (mm)	Length (mm)	Width (mm)
Single Fixing	45	45

C10



WHC/P
Combined finish



Centre (mm)	Length (mm)	Height (mm)	Width (mm)
Single Fixing	30	30	30

C14



WHC/P
Combined finish



Centre (mm)	Length (mm)	Height (mm)	Width (mm)
Single Fixing	75	35	23

GL02



CL/CH
Combined finish

Centre (mm)	Length (mm)	Height (mm)	Width (mm)
Single Fixing	35	28	35

GL03



CL/CH
Combined finish

Centre (mm)	Length (mm)	Height (mm)	Width (mm)
Single Fixing	35	32	35

MJ002



Centre (mm)	Length (mm)	Height (mm)	Width (mm)
Single Fixing	52	18	9

MJ003



Centre (mm)	Length (mm)	Height (mm)	Width (mm)
Single Fixing	30	25	30

T905K



Also available - see page 41



Centre (mm)	Length (mm)	Height (mm)	Width (mm)
16	40	20	40

PRODUCT CODE INDEX

Code	Page	Code	Page	Code	Page	Code	Page
1037	6	274	33	6820	44	AK0891	18
1062	6	276	33	688	12	AK0891B	18
1092	30	288	34	690	37	AK0894	18
1112	48	288K	49	7025	12	ARC	14
112	6	298	34	709	26	B	39
113	30	3047	9	8047	52	C	14
114	7	305	34	809	37	C10	54
1159	26	3061	35	809K	52	C14	54
116	30	3062	10	8230	37	C15	24
1160	48	3064	35	8391	23	CAPRI-C	19
1172	48	311	10	8392	23	CAPRI-J	19
1173	48	3130	10	8393	52	D	39
1179	49	325	11	8407	23	GL01	40
1186	22	3318	50	843	38	GL02	54
1186K	49	3319	11	843K	53	GL03	54
1208	22	3320	50	8457	27	IN2	40
122	7	3321	50	8513	44	MH14	40
139	49	3322	50	8645	38	MH20	27
1745	31	3323	51	8650	38	MJ001	15
1759	31	3380	11	8658	24	MJ002	55
202	31	3440	22	8721	44	MJ003	55
2050	7	3440K	51	8741	53	OK90	41
2051	8	3590	51	909	45	PESARO PULL	20
2053	8	3801	51	9238	13	R156	20
2060	8	508	35	929-1	53	T905	41
211XL	9	548	36	9718	13	T905K	55
216	32	6002	36	9908	13	TB	41
2188	9	6002K	52	9909	53	TSB	15
242	32	6316	26	9910	14	SSD	45
245	32	6329	12	A	39	SSTB	45
255	33	6330	36	AHS403	27		

Stefano Orlati

Australia

Stefano Orlati Brisbane

Stefano Orlati
23 Lisgar Street, Virginia, QLD 4014
Ph: 07 3865 1155
Fax: 07 3863 2999 (Fax)
Postal: PO Box 180, Geebung, QLD, 4014

Titus Tekform Brisbane

Titus Tekform Pty Ltd
1/32 Northlink Place, Virginia, QLD, 4014
Ph: 07 3266 3999
Fax: 07 3266 5234 (Fax)
Postal: PO Box 266, Northgate, QLD, 4013

Townsville

Titus Tekform Pty Ltd
20 Civil Road, Garbutt, QLD, 4814
Ph: 07 4779 1366
Fax: 07 4779 1316 (Fax)

Sydney

Titus Tekform Pty Ltd
Unit 1&2, 43-43 Whyalla Place, Prestons, NSW, 2170
Ph: 02 9826 0007
Fax: 02 9826 0074 (Fax)

Newcastle

Titus Tekform Pty Ltd
Unit 3, 100 Munibung Road, Cardiff, NSW, 2285
Ph: 02 4954 4011
Fax: 02 4954 4233 (Fax)

Melbourne

Titus Tekform Pty Ltd
8/59 Jersey Road, Bayswater, VIC, 3153
Ph: 03 9737 5566
Fax: 03 9729 8780 (Fax)
Postal: PO Box 357, Bayswater, VIC, 3153

Wodonga

Titus Tekform Pty Ltd
2/20 Mint Street, Wodonga, VIC, 3690
Ph: 02 6056 3188
Fax: 02 6056 3190 (Fax)

South Australia

Titus Tekform Pty Ltd
Ph: 08 8447 3700
Fax: 08 8447 3183 (Fax)
Postal: PO Box 357, Bayswater, VIC, 3153

Tasmania

Titus Tekform Pty Ltd
88 Hopkins Street, Moonah, TAS, 7009
Ph: 03 6273 1199
Fax: 03 6273 0050 (Fax)
Postal: PO Box 658, Moonah, TAS, 7009

New Zealand

Auckland

NZ Hardware Enterprises Ltd
34 Wajpareira Ave, Henderson 0610
Ph: 09 8370886
Fax: 09 837 8003
Postal: PO Box 21 398, Henderson, Auckland 0650

Christchurch

NZ Hardware Enterprises Ltd
162 Wordsworth Street, Sydenham 8023
Ph: 03 981 8518
Fax: 03 942 7296

Find a Customer Service nearby:

www.stefanohardware.com | www.titustekform.com.au