



**MARSHALLEXCELSIOR**  
innovation made simple

# 2020-2021

LP-GAS & NH3 EQUIPMENT CATALOG



PLANT | TRANSPORTATION | INDUSTRIAL | DOMESTIC | RECREATIONAL

# Contents

---

|                                      |         |
|--------------------------------------|---------|
| INTRODUCTION                         | 01      |
| OUR STORY                            | 02-03   |
| FEATURED NEW PRODUCTS                | 04-05   |
| EXCELA-FLO REGULATORS                | 06-51   |
| TRUCK AND PLANT EQUIPMENT            | 52-143  |
| ACCU-MAX FLOAT GAUGES                | 144-150 |
| PRESSURE RELIEF VALVES & MANIFOLDS   | 151-164 |
| DOT/ASME CONTAINER VALVES            | 165-176 |
| DISPENSING VALVES & ADAPTERS         | 177-182 |
| PIGTAILS, HOGTAILS & HOSE ASSEMBLIES | 183-187 |
| FITTINGS & ACCESSORIES               | 188-208 |
| REPLACEMENT PARTS & REPAIR KITS      | 209-217 |
| INDEX                                | 218-221 |
| WARRANTY                             | 222-223 |

## ABOUT THIS CATALOG

This catalog is designed to provide a comprehensive overview of Marshall Excelsior's products. Due to the continuous development and additions to our product lines, this catalog may not include all products Marshall Excelsior offers. To see any new products that have been developed after this publication visit [www.marshallexcelsior.com](http://www.marshallexcelsior.com).

Pictures in this catalog will resemble the product shown. However, due to continuous improvements and changes in regulations, we do not guarantee that the picture in this catalog will be the exact replica of the product purchased. Any pictures shown in a group of products will resemble the other products being offered in the same group unless otherwise stated.

Marshall Excelsior is a manufacturer of LP-Gas and anhydrous ammonia (NH<sub>3</sub>) equipment. Unless otherwise stated, all products are designed and manufactured to be used only with LP-Gas or NH<sub>3</sub> and can withstand temperatures from -40° to +180° Fahrenheit. If there is a product that you would like to use for a different application contact your authorized Marshall Excelsior Distributor or Marshall Excelsior before installing the product.

This catalog is for general information only and should not be viewed as an all inclusive catalog of important technical information, regulations, warnings or installation instructions. Contact your authorized Marshall Excelsior Distributor or Marshall Excelsior for more information.



# THE MEC STORY

Since 1976 Marshall Excelsior Company has been a progressive manufacturer of top quality and competitively priced LPG & NH<sub>3</sub> equipment that is leading the industry in **innovation and low emission products**. We offer a full range of products that support the LPG & NH<sub>3</sub> Bulk Plant, Transport, Delivery/Dispensing, and Domestic applications. As our product line continues to grow, we are striving to improve product functionality while taking the industry standards to a higher level of quality and performance without adding excessive cost. While following along this path, our engineering staff exercises a heavy reliance on the input from our customers throughout any new product design phase. It has been through these theories and approaches that we have been able to carve out our niche in an industry where safety and performance must work hand-in-hand. Our goal is to create the safest equipment solutions for everyday operations while allowing the largest amount of product to be transferred, dispensed, or otherwise used, resulting in an overall savings to the customer.

In addition to our company philosophy for new product development, you will find our approach to daily operations equally unique. In a time where materials, fuels, and other manufacturing costs are on the rise, we have not only remained competitive, but one of the industry leaders in on-time deliveries and short lead-times. The reason is simple; we not only manufacture our products effectively, but carry one of the most extensive on-hand inventories available in the industry. This allows our distributors to react quickly without having an excessive amount of stock on hand.

Put this together with our proactive, responsive sales and customer service staff and you have a winning combination.

As one of the industry leaders in responsiveness it is essential for our organization to be able to react in a rapid fashion, hence our fully integrated manufacturing and purchasing process. Our capabilities in manufacturing range from high volume to custom made product. Both of which are supported by our wide variety of manufacturing equipment, highly skilled personnel, and dedicated purchasing staff. Combine these attributes with our top notch ISO9001 quality system and you have a combination that easily rivals that of our nearest competition.

Over the course of time Marshall Excelsior Company has become a name that our customers can rely on not only for high quality products and services, but as a partner in building their business. Together, with our commitment to the industries served and our eagerness to improve and expand our product-line our customers routinely find the opportunity to promote our organization. It is through this personal touch that our business has become the organization that it is today.

## MEC is innovation made simple



# INDUSTRY INVOLVEMENT



## EVERYTHING STARTS WITH QUALITY



NEW



STAINLESS STEEL  
1-1/4" - 2" HIGH FLOW  
BYPASS VALVES

ME840SS & ME841SS Series  
(page 72)

STAINLESS STEEL  
3/4" COMBINATION VALVE



ME830SS  
(page 143)

EXCELERATOR™  
1-1/4" INTERNAL  
COMBINATION VALVE



ME1000 Series  
(page 90)

FLEX-VENT™ COMPACT REGULATOR  
VENT ADAPTER

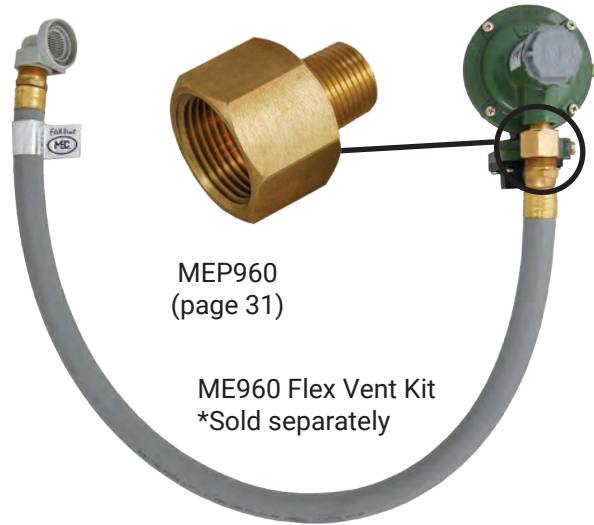

MEP960  
(page 31)

ME960 Flex Vent Kit  
\*Sold separately

3-1/4" EXTENDED ACME ADAPTER  
W/ INTEGRATED RELIEF & BLOWDOWN PORTS



ME503JT-16  
(page 131)

FIRE EMERGENCY SHUT OFF VALVES



EXCELA-FLO™ HIGH CAPACITY  
SECOND STAGE  
LIGHT COMMERCIAL  
REGULATORS

MEGR-1622C Series  
(page 23)



ME810FSV &  
ME820FSV Series  
(page 122)

# PRODUCTS



## HIGH PRESSURE INDUSTRIAL REGULATORS

MEGR-1584 & MEGR-1586 Series  
(page 44)

## STAINLESS STEEL LIQUID TRANSFER VALVES



ME449SS /ME449EXSS SERIES  
(page 142)



## MALE POL PROTECTIVE CAP

ME777-129  
(page 179)

## ACCU-MAX™ FLOAT GAUGE 30 DEGREE ANGLE MOUNT SERIES



ME930A/940A Series  
(page 149)



## 2" & 3" MNPT EXCESS FLOW VALVES FOR CONTAINER SERVICE

ME3600 Series  
(page 84)

## STAINLESS STEEL **VERSA-FILL™** HIGH FLOW BYPASS VALVES

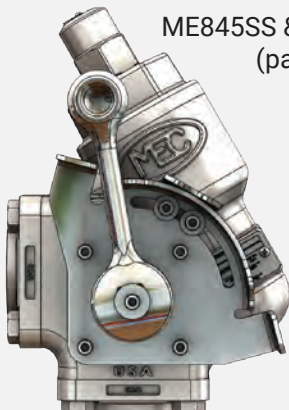

ME845SS & ME846SS Series  
(page 70-71)

## **EXCELA-FLANGE™** 2"-4 BOLT (3) EXTENDED HIGH FLOW TEE ADAPTER



MEP999SPE-16  
(page 66)

# FEATURES AND BENEFITS

1. Dust cap with hex and finger grips
2. Full round flange for evenly distributed compression
3. Bonnet locating tabs
4. Premium powder coat inside and out
5. Large wrench flats
6. Ribbed vent screen for easy removal
7. Fabric reinforced molded diaphragm
  - a. Interlocking diaphragm and diaphragm plate.
  - b. Rounded edges on diaphragm plate
  - c. Sealing and locating bead on diaphragm
8. Travel stops - to prevent damage to diaphragm
9. Stainless steel lever design
10. Pre-installed mounting screws for installation convenience
11. Large aluminum orifice
12. Large drip vent
13. Adjustment direction indicator
14. Plugged high pressure gauge port on all integral two stage regulators
15. 3 part tear off data label for installation records
16. (FKM) Fluorocarbon seats for maximum protection against contamination

\* Some features - Patent Pending

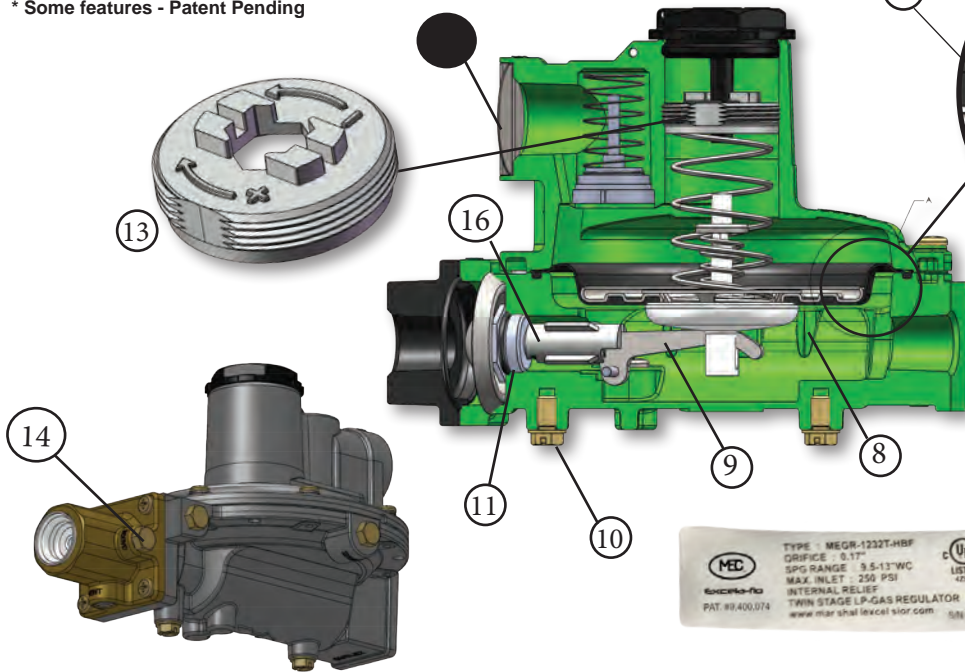
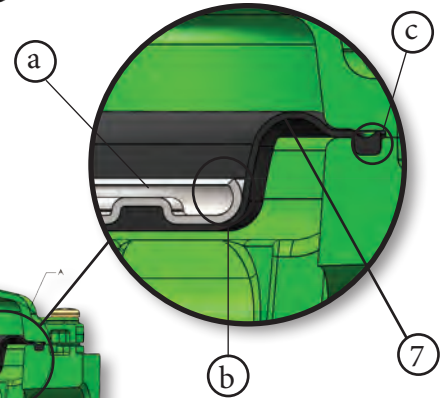
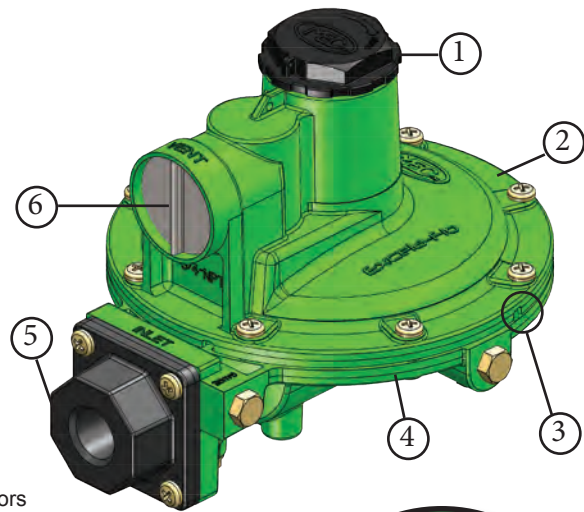

US PATENT  
# 9,400,074

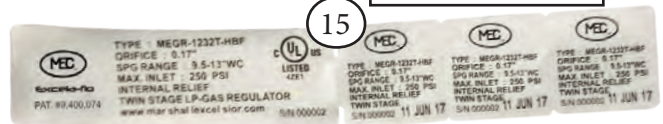

## SENTINEL™ DIELECTRIC INLET CONSTRUCTION

1. Mounting Screws
2. Reinforcement Plate
  - a. distributes mounting screw loads across plate
  - b. drip-lip to prevent water and condensation collection
3. Dielectric Isolator Plate and Cover
  - a. Isolator plate and cover install over the inlet flange to electrically insulate the inlet piping from the piping system that enters the building
  - b. plate is designed to isolate the mounting screws from the inlet
4. Dielectric 3/4" FNPT Flange Fitting
5. Double o-ring seal to prevent propane leaks

PATENT PENDING

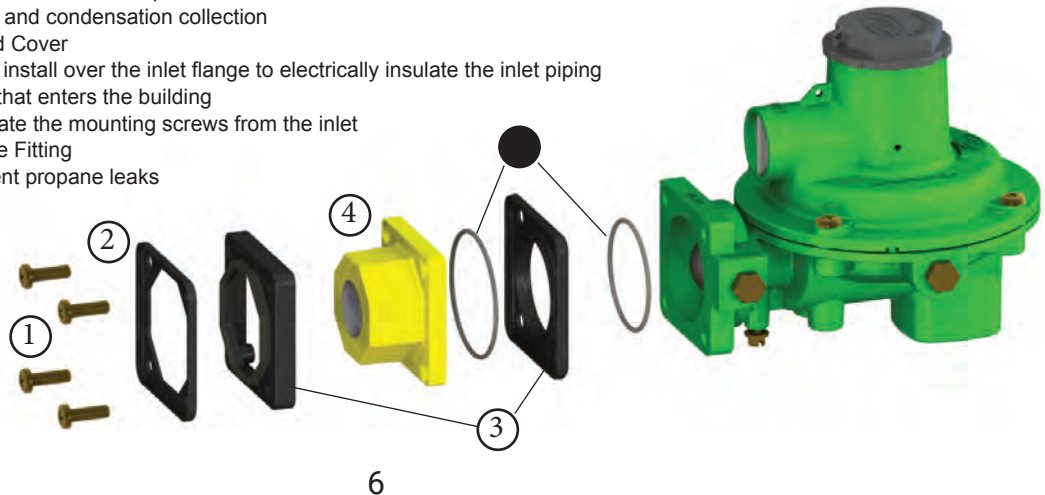

# INSTALLATION AND OPERATING INSTRUCTIONS

## MEGR-1100, 1200 AND 1600 SERIES

### !WARNING!

Failure to follow these instructions or to properly install and maintain this equipment could result in an explosion and/or fire causing property damage and personal injury or death.

Marshall Excelsior equipment must be installed, operated and maintained in accordance with federal, state and local codes and MEC instructions. The installation in most states must also comply with NFPA 54 and NFPA 58 standards.

Only personnel trained in the proper procedures, codes, standards and regulations of the LP-Gas industry shall install and service this equipment.



**WARNING:** These products contain a chemical known to the state of California to cause cancer and birth defects or reproductive harm.

### Things to tell the gas customer:

1. Show the customer the vent, vent assembly or vent line. Stress that this opening must remain unobstructed at all times. Tell the customer to check the vent opening after a freezing rain, sleet storm, or snow to make sure ice has not formed in the vent.
2. Show the customer the shutoff valve on the container. The customer should close this valve immediately if gas is smelled, appliance pilot lights fail to stay on or appear higher than usual or any other abnormal situation occurs.
3. Tell the customer to call your company to service the regulator if the regulator vents gas or a leak develops in the system. **Only a qualified gas service person shall install or service the regulators.**

### Scope of the Manual

This instruction manual covers installation and maintenance for the first stage, second stage, and integral two-stage regulators used on LP-Gas vapor service applications. **They are not to be used on liquid service.**

### Description

- **25 Year Recommended Replacement Life:** The MEC Regulator Series is designed using rugged time-proven design concepts and constructed of corrosion resistant materials, both internally and externally. With proper installation and periodic inspection and maintenance, they will meet a 25 Year Recommended Replacement Life.
- **Screened Drip-Lip:** Screened Drip-Lip is oriented either over the inlet, outlet, or at 90° depending on the configuration.
- **Pressure Tap Size Restrictions:** 1/8" NPT / #54 (0.055") orifice on all pressure points.
- **Temperature Capabilities:** -40°F to 160°F (-40°C to 71°C)

Contact the factory if the regulator is to be used on any service other than LP-Gas, or in a Severe Duty Application, or any application other than Domestic Type or Household Use. The following information is located on the spring case: The Part Number, orifice size, spring range and date code.

### 2nd Stage Low Pressure Regulator - UL Listed:



The second stage regulator is designed to reduce the outlet pressure from a first-stage regulator (usually 10 psig (0,69 bar)) to an outlet pressure of 11 -inches water column (27 millibars).

The combination of a high capacity relief valve and large vent provide overpressure protection which exceeds UL standards and is capable of limiting the downstream pressure to 2 psig (0,14 bar) even in a double failure situation when used with a first-stage regulator.

### Integral Two-Stage Regulator - UL Listed:



MEGR-1232 MEGR-1632  
FIGURE 2: INTEGRAL TWO-STAGE REGULATOR

The integral two-stage regulator contains a non-adjustable first stage regulator on the inlet of the second stage portion of the regulator. It is designed to reduce the tank pressure to an outlet pressure of 11 inches water column. The second stage portion has a high capacity internal relief valve construction. The first stage does not have an internal relief valve.

### First Stage Regulator - UL Listed:



MEGR-1222H MEGR-1622H  
FIGURE 3: FIRST STAGE REGULATOR

The first stage regulators are designed for high pressure (pounds per square inch) vapor service. These regulators have high capacity internal relief valves. The outlet pressure setting is factory set at a nominal 10 psig (0,69 bar).

### 2 PSI Service Regulator - UL Listed:

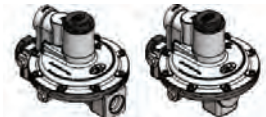

MEGR-1622E MEGR-1652E  
FIGURE 4: 2 PSI SERVICE REGULATOR

The 2 PSI service regulator is designed to reduce the outlet pressure from a first-stage regulator (usually 10 psig (0,69 bar)) to a nominal outlet pressure of 2 psig (0,14 bar).

The combination of high capacity relief valve and large vent provide overpressure protection which exceeds UL standards and is capable of limiting the downstream pressure in a double failure situation when used with a first-stage regulator.

### 2-PSI Integral Two Stage Regulator - UL Listed:



MEGR-1232E MEGR-1632E  
FIGURE 5: 2 PSI INTEGRAL TWO-STAGE REGULATOR

The integral two-stage 2 PSI regulator contains a non-adjustable first stage regulator on the inlet of the second stage portion of the regulator. It is designed to reduce the tank pressure to a nominal outlet pressure of 2 psig (0,14 bar). The second stage portion has a high capacity internal relief valve construction. The first stage does not have an internal relief valve.

### Installation

#### !WARNING!

All vents should be kept open to permit free flow of air in and out of the regulator. Protect vent openings against the entrance of rain, snow, ice formation, paint, mud, insects or any other foreign material that could plug the vent or vent line.



# INSTALLATION AND OPERATING INSTRUCTIONS

## MEGR-1100, 1200 AND 1600 SERIES

### Installation (Continued)

#### **!WARNING!**

LP-Gas may discharge to the atmosphere through the vent. An obstructed vent which limits air or gas flow can cause abnormally high pressure that could result in personal injury or property damage.

The first stage and integral two-stage regulators are not suitable for indoor installations. Never use them on low pressure (inches of water column) service because personal injury or property damage could occur.

#### Before installation:

- Check for damage, which may have occurred in shipment.
- Check for and remove any dirt or foreign material that may have accumulated in the regulator body.
- Replace old pigtails. Blow out any debris, dirt or copper sulfate in the copper tubing and the pipeline.
- Apply pipe compound to the male threads of the pipe before installing the regulator.
- Make sure gas flow through the regulator is in the same direction as the arrow on the body. "Inlet" and "Outlet" connections are clearly marked.

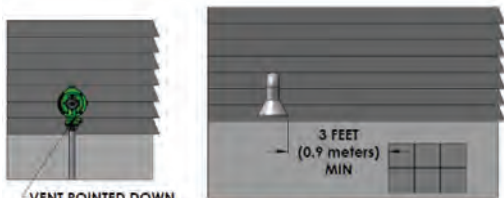
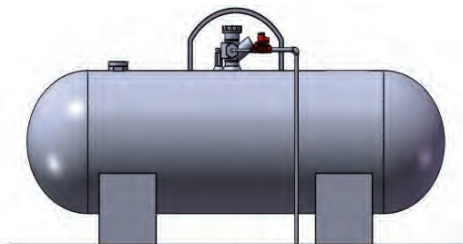

Figure 2: Regulator with Vent Pointed Down

#### Installation Location, see Figure 2:

- The installed regulator should be adequately protected from vehicular traffic and damage from other external sources.
- **Install the regulator with the vent pointed vertically down.** If the vent cannot be installed in a vertically down position, the regulator must be installed under a separate protective cover. Installing the regulator with the vent down allows condensation to drain, minimizes the entry of water or other debris from entering the vent, and minimizes vent blockage from freezing precipitation.
- **Do not install the regulator in a location where there can be excessive water accumulation or ice formation,** such as directly beneath a down spout, gutter or roof line of building. Even a protective hood may not provide adequate protection in these instances.
- Install the regulator so that any gas discharge through the vent or vent assembly is over 3-feet (0.9 meters) horizontally from any building opening below the level of discharge and not less than 5-feet in any direction away from any source of ignition, openings into direct vent appliances, or mechanical ventilation air intakes.
- Install the regulator high enough above ground level - at least 24-inches (60 cm) - so that rain splatter cannot freeze in the vent.
- Some installations, such as in areas with heavy snowfall, may require a hood or enclosure to protect the regulator from snow load and vent freeze over.



#### Horizontally Installed Regulators, see Figure 3:

Horizontally mounted regulators, such as found in single cylinder installations and ASME tanks, must be installed beneath a protective cover or under the ASME tank dome. If possible, slope or turn the vent down sufficiently to allow any condensation to drain out of the spring case. Be careful that the slot in the tank dome or protective cover for the regulator's outlet piping does not expose the vent to the elements. The first stage vent on the integral two-stage regulator should be pointed down.

#### Indoor Installations, see Figure 4:

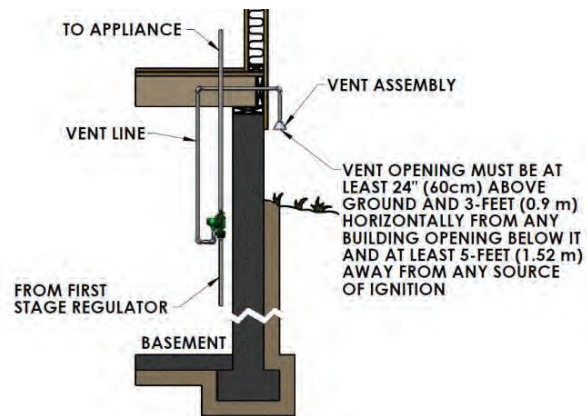

Figure 4: Basement Installation

The first stage and integral regulators are not recommended for indoor installations. The second stage regulator may be installed indoors as follows.

By code, regulators installed indoors have limited inlet pressure, and they **require** a vent line to the outside of the building. A vent assembly, such as MEC ME960 or at least 3/4" NPT pipe, Gray PVC Schedule 40 Rigid Non-Metallic Electrical Conduit for above Ground Service, per UL 651, should be used. The same installation precautions, previously discussed throughout this manual for the regulator vent, apply to the end of the vent tube assembly. Vent lines must not restrict the gas flow from the regulator's internal relief valve. To install the vent line, remove the vent screen and apply a good grade of pipe compound to the male threads of the line. Vent lines should be as straight as possible with a minimum number of bends.

#### Underground Installations, see Figure 5:

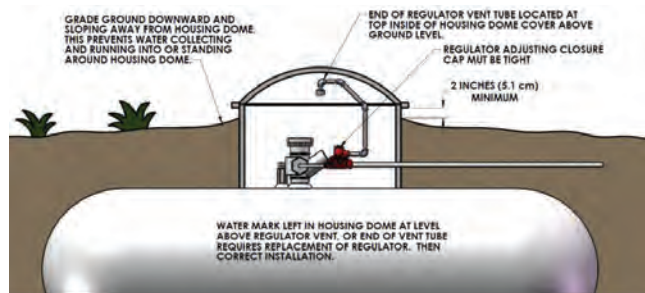

Figure 5: Underground Installation

#### **!WARNING!**

The integral two-stage regulators require 2 vent lines, one for the first stage vent (1/4" OD copper tube inverted flare connection: 7/16-24 UN thread) and the other for the second stage vent (3/8" NPT) of the regulator. Failure to use 2 separate vent tubes can result in early regulator failure and / or overpressuring the second stage that could result in fire or personal injury.

A regulator installed in the dome of an underground container requires a vent line to prevent water from entering the regulator spring case. Remove the vent screen(s) and install a vent line(s). The vent line must be run from the regulator vent(s) to above the maximum water table. The vent line opening(s) must terminate at the extreme top inside of the dome cover. Make sure the regulator's closing cap is on tightly, and maintain drainage away from the dome at all times.

#### Adjustment

Each regulator is factory set. If it becomes necessary to increase the outlet pressure, remove the closing cap and turn the adjustment screw clockwise. Turn the adjusting screw counterclockwise to decrease the outlet pressure.

The inlet and outlet pressure tap plugs may be removed using a 7/16" wrench. The pressure tap is restricted with a #54 orifice, so the plug can be removed with pressure in the regulator. Install a pressure gauge to determine the regulator's inlet pressure and outlet setting during adjustment. Actual pressure at the second stage regulator may be less due to line loss. After setting, add thread sealant to the pipe plug and reinstall it. Replace the closing cap. Check the plug for leakage.

#### Overpressure Protection

##### !WARNING!

**Some type of overpressure protection is needed if actual inlet pressure can exceed the inlet pressure rating. Overpressuring any portion of this equipment above the limits shown in the Specifications may cause damage to regulator parts, leaks in the regulator, or personal injury due to bursting of pressure-containing parts or explosion of accumulated gas.**

**If any portion of the regulator is exposed to an overpressure condition that exceeds the limits in the Specifications, it must be inspected for damage that may have occurred.**

**Large volumes of gas may discharge through the regulator vent during internal relief valve operation, which can, if not controlled, result in fire or explosion from accumulated gas.**

The first stage, integral two-stage, and second stage series regulator, **except for the first stage of the integral two-stage**, contain internal relief valves. The internal relief valve in all units will give overpressure protection against excessive build-up resulting from seat leakage due to worn parts, chips or foreign material on the orifice. The amount of internal relief protection provided varies with the regulator type and the cause for the overpressure relief valve operation. When the internal relief valve opens, gas escapes to the atmosphere through the regulator's vent.

Some type of additional external overpressure protection must be provided if the outlet pressure in an overpressure condition exceeds the inlet pressure rating of the gas system or downstream equipment. Common methods of external overpressure protection include relief valves, monitoring regulators, shutoff devices, and series regulation.

#### Maintenance

##### !WARNING!

**To avoid personal injury or equipment damage, do not attempt any maintenance or disassembly without first isolating the regulator from system pressure and relieving all internal pressure.**

**Regulators that have been disassembled for repair must be tested for proper operation before being returned to service. Only parts manufactured by MEC should be used for repairing MEC regulators. Relight pilot lights according to normal startup procedures found in the appliance manufacturers' instructions. Due to normal wear or damage that may occur from external sources, these regulators must be inspected and maintained**

**periodically. The frequency of inspection and replacement of the regulators depends upon the severity of service conditions or the requirements of local, state and federal regulations. Even under ideal conditions, these regulators should be replaced after 25 years from date of manufacture or sooner should inspection reveal the need.**

Visually inspect the regulator each time a gas delivery is made for:

- Improper installation; such as vent not pointed vertically down or under a cover, no vent line on underground systems
- Plugged or frozen vent
- Wrong regulator or no regulator in the system
- External corrosion
- Flooded Regulator; water in spring case, regulator submersed on underground tanks
- Regulator age
- Any other condition that could cause the uncontrolled escape of gas

**Failure to do the above could result in personal injury or property damage.**

#### Vent Opening

Make sure the regulator vent, vent assembly, or vent line does not become plugged by mud, insects, ice, snow, paint, etc. The vent screen aids in keeping the vent from becoming plugged; the screen should be clean and properly installed.

#### Water inside Regulators from Floods, Weather or Water Table on Underground Systems

Replace any regulator that has been flooded or has been submersed below the water, has water in the spring case or shows evidence of external or internal corrosion. Checking for internal corrosion on the first stage and integral two-stage of the second stage portion, can be done by removing the closing cap and with the aid of a flashlight observing the condition of the relief valve spring, main spring and internal spring barrel area. A more detailed examination will require shutting down the gas system and the complete removal of the adjusting screw. The second stage regulator must be completely disassembled by a qualified person to look for internal corrosion. Closely examine regulators installed with their vent horizontal for signs of corrosion. Correct any improper installations.

#### Regulator Replacement

Older regulators are more likely to fail catastrophically because of worn or corroded parts. Replace all regulators over 25 years of age. Other service or environmental conditions may dictate replacement of the regulator before the end of its 25 year service life.

Regulators that are installed on underground systems and in areas that are subject to sea salt (coastal) atmospheres should be inspected annually for external and internal corrosion and may require replacement sooner.

#### Regulator Repair

**Only personnel trained in the proper procedures, codes, standards and regulations of the LP-Gas industry shall install and service this equipment.**

Regulators that have been disassembled for repair must be tested for proper operation before being returned to service. Only parts manufactured by MEC should be used to repair MEC regulators. Be sure to give the complete Part Number of the regulator when corresponding with the factory.

The part number, orifice size, and spring range are on a label attached to the spring barrel. The date of manufacture is stamped on the regulator. Always provide this information in any correspondence with your MEC Distributor regarding replacement parts or technical assistance. **If construction changes are made in the field, be sure that the regulator marking is also changed to reflect the most recent construction.**

# SPECIFICATIONS - MEGR-1100 AND 1200 SERIES

## EXCELA-FLO™ REGULATORS



TABLE 1: 1100 AND 1200 SERIES SPECIFICATIONS

| REGULATOR APPLICATION    | PART NUMBER           | CAPACITY BTU/HR PROPANE (1) | INLET CONNECTION | OUTLET CONNECTION | 3/8-INCH FNPT SCREENED VENT STANDARD LOCATION      | NOMINAL RELIEF VALVE START-TO-DISCHARGE | MAX OUTLET PRESSURE WITH DISC REMOVED |                     | ORIFICE SIZE     | MAX ALLOWABLE INLET PRESSURE | MAX EMERGENCY INLET PRESSURE | OUTLET PRESSURE STANDARD SETPOINT   | OUTLET PRESSURE SPRING RANGE   | REGULATOR COLOR |
|--------------------------|-----------------------|-----------------------------|------------------|-------------------|--|---|---------------------------------------|---------------------|------------------|------------------------------|------------------------------|---|--|-----------------|
|                          |                       |                             |                  |                   |  |   | INLET PRESSURE                        | MAX OUTLET PRESSURE |                  |                              |                              |   |  |                 |
| Second Stage             | MEGR-1222-BAF         | 450,000                     | 1/2-in FNPT (7)  | 1/2-in FNPT       | Over Inlet   | 1 psi (0.07 bar)                        | 30 psig (2.07 bar)                    | 2 psig (0.14 bar)   | 0.14-in (3.6 mm) | 10 psig (0.69 bar)           | 75 psig (5.2 bar)            | 11-in w.c. (27 mbar)  | 9.5 to 13-in w.c. (24 to 32 mbar)  | Green           |
|                          | MEGR-1222-CFF         | 800,000                     | 3/4-in FNPT (7)  | 3/4-in FNPT       |  |   |                                       |                     |                  |                              |                              |   |  |                 |
|                          | MEGR-1222-DFE         | 500,000                     | 1/2-in FNPT (7)  | 1/2-in FNPT (6)   |  |   |                                       |                     |                  |                              |                              |   |  |                 |
|                          | MEGR-1252-BAF         | 650,000                     | 3/4-in FNPT (7)  | 3/4-in FNPT (6)   |  |   |                                       |                     |                  |                              |                              |   |  |                 |
|                          | MEGR-1252-CFF         | 700,000                     | 1/4-in FNPT      | 1/2-in FNPT       |  |   |                                       |                     |                  |                              |                              |   |  |                 |
|                          | MEGR-1232-HBF (3)     | 450,000                     | FPOL Tee         | 1/2-in FNPT       |  |   |                                       |                     |                  |                              |                              |   |  |                 |
| Integral Two-Stage       | MEGR-1232T-HBF (4)    | 625,000                     | FPOL Tee         | 3/4-in FNPT       | First Stage (2): Down<br>Second Stage: Over Outlet | 4 psi (0.28 bar)                        | 250 psig (17.2 bar)                   | 5 psig (0.34 bar)   | 0.17-in (4.3 mm) | 250 psig (17.2 bar)          | 250 psig (17.2 bar)          | First Stage:<br>=10 psi (0.69 bar)<br>Second Stage:<br>11-in w.c. (27 mbar) | First Stage:<br>non-adjustable<br>Second Stage:<br>9.5 to 13-in w.c. (24 to 32 mbar) | Gray            |
|                          | MEGR-1232T-HFF (5)    | 500,000                     | 1/4-in FNPT      | 1/2-in FNPT       |  |   |                                       |                     |                  |                              |                              |   |  |                 |
|                          | MEGR-1232E-HBF (3)    | 1,000,000                   | FPOL             | 1/2-in FNPT       |  |   |                                       |                     |                  |                              |                              |   |  |                 |
|                          | MEGR-1232E-HBH (3)    | 1,700,000                   | FPOL Tee         | 3/4-in FNPT       |  |   |                                       |                     |                  |                              |                              |   |  |                 |
| 2 PSI (0.14 bar) Service | MEGR-1122H-AAJ (3)(5) | 1,000,000                   | 1/4-in FNPT      | 1/2-in FNPT       | Over Outlet  | 16 psi (1.10 bar)                       | Not Applicable                        | 5 psig (0.34 bar)   | 0.15-in (3.8 mm) | 250 psig (17.2 bar)          | 250 psig (17.2 bar)          | 2 psig (0.14 bar)   | 1.0 to 2.2 psi (0.069 to 0.15 bar)   | White           |
|                          | MEGR-1222H-BGF (3)(5) | 1,700,000                   | FPOL             | 1/2-in FNPT       |  |   |                                       |                     |                  |                              |                              |   |  |                 |
|                          | MEGR-1222H-BGJ (3)    | 1,400,000                   | FPOL Tee         | 3/4-in FNPT       |  |   |                                       |                     |                  |                              |                              |   |  |                 |
|                          | MEGR-1252H-BGF (3)    | 1,500,000                   | FPOL             | 1/2-in FNPT (6)   |  |   |                                       |                     |                  |                              |                              |   |  |                 |
|                          | MEGR-1252H-BGJ (3)    |                             | FPOL             | 3/4-in FNPT (6)   |  |   |                                       |                     |                  |                              |                              |   |  |                 |
|                          | MEGR-1252H-BGJ (3)    |                             | FPOL             | 1/2-in FNPT (6)   |  |   |                                       |                     |                  |                              |                              |   |  |                 |

(1): Capacities Based on:

- Second Stage: 10 psig (0.69 bar) inlet pressure with 2-inches w.c. (5 mbar) droop.
- Integral Second Stage: 30 psig (2.07 bar) inlet pressure and 2-inches w.c. (5 mbar) droop.
- First Stage: 30 psig (2.07 bar) inlet pressure and 20% droop.

(2): Integral First Stage Vent size: 7/16-24 UN thread for 1/4-inch OD copper tube inverted flare fitting.

(3): "XA" option available; First Stage Vent (2) Down, Second Stage Vent opposite Gauge Taps

(4): "XA" option available; First Stage Vent (2) opposite Gauge Taps, Second Stage Vent opposite Gauge Taps

(5): "XB" option available; Vent over Gauge Taps

(6): Back mount outlet port

(7): Sentinel™ Dielectric inlet port option available

# SPECIFICATIONS - MEGR-1600 SERIES

































TABLE 2: 1600 SERIES SPECIFICATIONS

| REGULATOR APPLICATION    | PART NUMBER          | CAPACITY BTU/HR PROPANE (1) | INLET CONNECTION | OUTLET CONNECTION | 3/4-INCH FNPT SCREENED VENT STANDARD LOCATION            | NOMINAL RELIEF VALVE START-TO-DISCHARGE | MAX OUTLET PRESSURE WITH DISC REMOVED |                     | ORIFICE SIZE     | MAX ALLOWABLE INLET PRESSURE | MAX EMERGENCY INLET PRESSURE | OUTLET PRESSURE STANDARD SETPOINT   | OUTLET PRESSURE SPRING RANGE   | REGULATOR COLOR |
|--------------------------|----------------------|-----------------------------|------------------|-------------------|--|---|---------------------------------------|---------------------|------------------|------------------------------|------------------------------|---|--|-----------------|
|                          |                      |                             |                  |                   |  |   | INLET PRESSURE                        | MAX OUTLET PRESSURE |                  |                              |                              |   |  |                 |
| Second Stage             | MEGR-1622-BCF        | 710,000                     | 1/2-in FNPT (9)  | 1/2-in FNPT       | Over Inlet   | 1 psi (0.07 bar)                        | 50 psig (3.4 bar)                     | 2 psig (0.14 bar)   | 7/32-in (5,6 mm) | 10 psig (0.69 bar)           | 15 psig (1.03 bar)           | 11-in w.c. (27 mbar)  | 9 to 13-in w.c. (22 to 32 mbar)  | Green           |
|                          | MEGR-1622-CFF (6)    | 1,300,000                   | 3/4-in FNPT      | 3/4-in FNPT       |  |   |                                       |                     |                  |                              |                              |   |  |                 |
|                          | MEGR-1622-DFE (6)    | 900,000                     | 3/4-in FNPT (7)  | 3/4-in FNPT (7)   |  |   |                                       |                     |                  |                              |                              |   |  |                 |
|                          | MEGR-1642-DFE        | 1,000,000                   | 1/2-in FNPT (9)  | 3/4-in FNPT (8)   |  |   |                                       |                     |                  |                              |                              |   |  |                 |
|                          | MEGR-1652-CFF        | 700,000                     | 1/4-in FNPT      | 1/2-in FNPT       |  |   |                                       |                     |                  |                              |                              |   |  |                 |
|                          | MEGR-1632-BCF (3)    | 950,000                     | FPOL             | 3/4-in FNPT       |  |   |                                       |                     |                  |                              |                              |   |  |                 |
| Integral Two-Stage       | MEGR-1632-HCF (3)    | 900,000                     | FPOL Tee         | 1/4-in FNPT       | First Stage (2):<br>Down<br>Second Stage: Over<br>Outlet | 4 psi (0.28 bar)                        | 250 psig (17.2 bar)                   | 5 psig (0.34 bar)   | 7/32-in (5,6 mm) | 250 psig (17.2 bar)          | 250 psig (17.2 bar)          | First Stage:<br>≈10 psi (0.69 bar)<br>Second Stage:<br>11-in w.c. (27 mbar) | First Stage:<br>non-adjustable<br>Second Stage:<br>9 to 13-in w.c. (22 to 32 mbar) | Gray            |
|                          | MEGR-1632T-HCF (4)   | 1,100,000                   | 1/4-in FNPT      | 1/2-in FNPT       |  |   |                                       |                     |                  |                              |                              |   |  |                 |
|                          | MEGR-1632T-HCF (4)   | 1,400,000                   | FPOL             | 3/4-in FNPT       |  |   |                                       |                     |                  |                              |                              |   |  |                 |
|                          | MEGR-1632T-HCF (4)   | 1,300,000                   | FPOL Tee         | 3/4-in FNPT (8)   |  |   |                                       |                     |                  |                              |                              |   |  |                 |
|                          | MEGR-1632-JFF (3)(5) | 850,000                     | 1/4-in FNPT      | 1/2-in FNPT       |  |   |                                       |                     |                  |                              |                              |   |  |                 |
|                          | MEGR-1632T-JFF (4)   | 900,000                     | FPOL             | 3/4-in FNPT       |  |   |                                       |                     |                  |                              |                              |   |  |                 |
| 2 Psi (0.14 bar) Service | MEGR-1622E-BCH       | 1,100,000                   | 1/2-in FNPT (9)  | 1/2-in FNPT       | Over Inlet   | 4 psi (0.28 bar)                        | 50 psig (3.4 bar)                     | 5 psig (0.34 bar)   | 7/32-in (5,6 mm) | 10 psig (0.69 bar)           | 15 psig (1.03 bar)           | 2 psig (0.14 bar)   | 1.0 to 2.2 psi (0.069 to 0.15 bar)   | White           |
|                          | MEGR-1622E-DCH       | 1,400,000                   | 1/2-in FNPT      | 1/2-in FNPT       |  |   |                                       |                     |                  |                              |                              |   |  |                 |
|                          | MEGR-1652E-DFH       | 1,300,000                   | 3/4-in FNPT (9)  | 3/4-in FNPT (8)   |  |   |                                       |                     |                  |                              |                              |   |  |                 |
|                          | MEGR-1632E-BCH (3)   | 850,000                     | 1/4-in FNPT      | 1/2-in FNPT       |  |   |                                       |                     |                  |                              |                              |   |  |                 |
|                          | MEGR-1632E-CFH (3)   | 900,000                     | FPOL             | 3/4-in FNPT       |  |   |                                       |                     |                  |                              |                              |   |  |                 |
|                          | MEGR-1632E-JFH (3)   | 850,000                     | FPOL             | 3/4-in FNPT       |  |   |                                       |                     |                  |                              |                              |   |  |                 |
| First Stage              | MEGR-1622H-BGJ       | 2,200,000                   | 1/2-in FNPT      | 1/2-in FNPT       | First Stage (2):<br>Down<br>Second Stage: Over<br>Outlet | 18 psi (1.24 bar)                       | Not Applicable                        | Not Applicable      | 7/32-in (5,6 mm) | 250 psig (17.2 bar)          | 250 psig (17.2 bar)          | 10 psi (0.69 bar)   | 8 to 12 psi (0.55 to 0.83 bar)   | Red             |
|                          | MEGR-1622H-DGJ       | 2,500,000                   | 3/4-in FNPT      | 3/4-in FNPT       |  |   |                                       |                     |                  |                              |                              |   |  |                 |
|                          | MEGR-1622H-HGJ       | 2,300,000                   | FPOL             | 1/2-in FNPT       |  |   |                                       |                     |                  |                              |                              |   |  |                 |
|                          | MEGR-1622HT-HGJ      | 2,750,000                   | FPOL Tee         | 3/4-in FNPT       |  |   |                                       |                     |                  |                              |                              |   |  |                 |
|                          | MEGR-1622HT-JGJ      | 2,100,000                   | FPOL Tee         | 3/4-in FNPT       |  |   |                                       |                     |                  |                              |                              |   |  |                 |
|                          | MEGR-1622H-BGK       | 2,200,000                   | 1/2-in FNPT      | 1/2-in FNPT       |  |   |                                       |                     |                  |                              |                              |   |  |                 |
| MEGR-1622H-HGK           | 2,650,000            | FPOL                        | 3/4-in FNPT      |                   |  |   |                                       |                     |                  |                              |                              |   |  |                 |

(1): Capacities Based on:  
 Second Stage: 10 psig (0.69 bar) inlet pressure with 2-inches w.c. (5 mbar) droop.  
 Integral Second Stage: 30 psig (2.07 bar) inlet pressure and 2-inches w.c. (5 mbar) droop.  
 First Stage: 30 psig (2.07 bar) inlet pressure and 20% droop.  
 (2): Integral First Stage Vent size: 7/16-24 UN thread for 1/4-inch OD copper tube inverted flare fitting.  
 (3): "XA" option available; First Stage Vent (2) Down, Second Stage Vent opposite Gauge Taps  
 (4): "XA" option available; First Stage Vent (2) opposite Gauge Taps, Second Stage Vent opposite Gauge Taps  
 (5): "XB" option available; Vent over Gauge Taps  
 (6): "XO" option available, Vent over outlet  
 (7): Side discharge outlet port  
 (8): Back mount outlet port  
 (9): Sentinel™ Dielectric inlet port option available

# DOMESTIC - FIRST/SECOND STAGE REFERENCE GUIDE

EXCELA-FLO™ REGULATORS

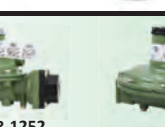
| LOAD<br>BTU/HR.  | DISTANCE<br>Maximum distance<br>from 1st Stage<br>Regulator to<br>2nd Stage Regulator   | PIPE SIZE<br>Between 1st<br>and 2nd Stage<br>Regulator  | MEC<br>REGULATOR  | MEC PIGTAILS  | MEC<br>DIELECTRIC<br>UNIONS  |                 |             |             |             |             |             |             |            |
|--|---|---|---|---|--|-----------------|-------------|-------------|-------------|-------------|-------------|-------------|------------|
| 400,000  | 80 Feet   | 1/2" CTS<br>iron pipe<br>or 1/2" OD<br>copper tubing<br>@ 10 PSI  | <b>1ST STAGE</b><br><br>Compact<br><b>MEGR-1122H-AAJ</b> 1/4" x 1/2"<br><b>MEGR-1222H-BGF</b> F. POL x 1/2"  | <br><b>1/4" X POL</b>   Length   Part No.<br>3/8" tube OD   12"   ME1689-12<br>1/4" tube OD   12"   ME1669-12<br>1/4" tube OD   6"   ME1669-06  | *See pg. 185<br><br><table border="1"> <thead> <tr> <th>MNPT X M. FLARE</th> <th>Part No.</th> </tr> </thead> <tbody> <tr> <td>1/2"   3/8"</td> <td>ME690-4-6</td> </tr> <tr> <td>1/2"   1/2"</td> <td>ME690-4-8</td> </tr> <tr> <td>1/2"   5/8"</td> <td>ME690-4-10</td> </tr> </tbody> </table> | MNPT X M. FLARE | Part No.    | 1/2"   3/8" | ME690-4-6   | 1/2"   1/2" | ME690-4-8   | 1/2"   5/8" | ME690-4-10 |
|  |   |   | MNPT X M. FLARE   | Part No.  |  |                 |             |             |             |             |             |             |            |
| 1/2"   3/8"  | ME690-4-6   |   |   |   |  |                 |             |             |             |             |             |             |            |
| 1/2"   1/2"  | ME690-4-8   |   |   |   |  |                 |             |             |             |             |             |             |            |
| 1/2"   5/8"  | ME690-4-10  |   |   |   |  |                 |             |             |             |             |             |             |            |
| <b>2ND STAGE</b><br><br>Compact<br><b>MEGR-1222-BAF</b> 1/2" x 1/2"<br><b>MEGR-1222-CFF</b> 1/2" x 3/4"<br>Backmounts<br><b>MEGR-1252-BAF</b> 1/2" x 1/2"<br><b>MEGR-1252-CFF</b> 1/2" x 3/4" | <br><b>POL X POL</b>   Length   Part No.<br>3/8" tube OD   12"   ME1680-12<br>1/4" tube OD   12"   ME1664-12<br>3/8" tube OD   6"   ME1680-06 | <table border="1"> <thead> <tr> <th>MNPT X M. FLARE</th> <th>Part No.</th> </tr> </thead> <tbody> <tr> <td>1/2"   3/8"</td> <td>ME690-4-6</td> </tr> <tr> <td>1/2"   1/2"</td> <td>ME690-4-8</td> </tr> <tr> <td>1/2"   5/8"</td> <td>ME690-4-10</td> </tr> </tbody> </table> | MNPT X M. FLARE   | Part No.  | 1/2"   3/8"  | ME690-4-6       | 1/2"   1/2" | ME690-4-8   | 1/2"   5/8" | ME690-4-10  |             |             |            |
| MNPT X M. FLARE  | Part No.  |   |   |   |  |                 |             |             |             |             |             |             |            |
| 1/2"   3/8"  | ME690-4-6   |   |   |   |  |                 |             |             |             |             |             |             |            |
| 1/2"   1/2"  | ME690-4-8   |   |   |   |  |                 |             |             |             |             |             |             |            |
| 1/2"   5/8"  | ME690-4-10  |   |   |   |  |                 |             |             |             |             |             |             |            |
| 600,000  | 40 Feet   | 1/2" CTS<br>iron pipe<br>or 1/2" OD<br>copper tubing<br>@ 10 PSI  | <b>1ST STAGE</b><br><br>Compact<br><b>MEGR-1122H-AAJ</b> 1/4" x 1/2"<br><b>MEGR-1222H-BGF</b> F. POL x 1/2"<br><b>MEGR-1222H-BGJ</b> 1/2" x 3/4"       | <br><b>1/4" X POL</b>   Length   Part No.<br>3/8" tube OD   12"   ME1689-12<br>1/4" tube OD   12"   ME1669-12<br>1/4" tube OD   6"   ME1669-06  | <br><table border="1"> <thead> <tr> <th>MNPT X M. FLARE</th> <th>Part No.</th> </tr> </thead> <tbody> <tr> <td>1/2"   3/8"</td> <td>ME690-4-6</td> </tr> <tr> <td>1/2"   1/2"</td> <td>ME690-4-8</td> </tr> <tr> <td>1/2"   5/8"</td> <td>ME690-4-10</td> </tr> </tbody> </table>                 | MNPT X M. FLARE | Part No.    | 1/2"   3/8" | ME690-4-6   | 1/2"   1/2" | ME690-4-8   | 1/2"   5/8" | ME690-4-10 |
|  | MNPT X M. FLARE   | Part No.  |   |   |  |                 |             |             |             |             |             |             |            |
|  | 1/2"   3/8"   | ME690-4-6   |   |   |  |                 |             |             |             |             |             |             |            |
| 1/2"   1/2"  | ME690-4-8   |   |   |   |  |                 |             |             |             |             |             |             |            |
| 1/2"   5/8"  | ME690-4-10  |   |   |   |  |                 |             |             |             |             |             |             |            |
| 100 Feet   | 5/8" OD<br>copper tubing<br>@ 10 PSI  | <b>2ND STAGE</b><br><br>Compact<br><b>MEGR-1222-BAF</b> 1/2" x 1/2"<br><b>MEGR-1222-CFF</b> 1/2" x 3/4"<br><b>MEGR-1222-DFD</b> 3/4" x 3/4"  | <br><b>POL X POL</b>   Length   Part No.<br>3/8" tube OD   12"   ME1680-12<br>1/4" tube OD   12"   ME1664-12<br>3/8" tube OD   6"   ME1680-06         | <table border="1"> <thead> <tr> <th>MNPT X M. FLARE</th> <th>Part No.</th> </tr> </thead> <tbody> <tr> <td>1/2"   3/8"</td> <td>ME690-4-6</td> </tr> <tr> <td>1/2"   1/2"</td> <td>ME690-4-8</td> </tr> <tr> <td>1/2"   5/8"</td> <td>ME690-4-10</td> </tr> </tbody> </table> | MNPT X M. FLARE  | Part No.        | 1/2"   3/8" | ME690-4-6   | 1/2"   1/2" | ME690-4-8   | 1/2"   5/8" | ME690-4-10  |            |
| MNPT X M. FLARE  | Part No.  |   |   |   |  |                 |             |             |             |             |             |             |            |
| 1/2"   3/8"  | ME690-4-6   |   |   |   |  |                 |             |             |             |             |             |             |            |
| 1/2"   1/2"  | ME690-4-8   |   |   |   |  |                 |             |             |             |             |             |             |            |
| 1/2"   5/8"  | ME690-4-10  |   |   |   |  |                 |             |             |             |             |             |             |            |
| 1,000 Feet   | 3/4" IPS<br>iron pipe<br>@ 10 PSI   | Backmounts<br><b>MEGR-1252-BAF</b> 1/2" x 1/2"<br><b>MEGR-1252-CFF</b> 1/2" x 3/4"<br><b>MEGR-1252-DFD</b> 3/4" x 3/4"  | <br><b>POL X POL</b>   Length   Part No.<br>3/8" tube OD   12"   ME1680-12<br>1/4" tube OD   12"   ME1664-12<br>3/8" tube OD   6"   ME1680-06         | <table border="1"> <thead> <tr> <th>MNPT X M. FLARE</th> <th>Part No.</th> </tr> </thead> <tbody> <tr> <td>3/4"   3/8"</td> <td>ME690-6-6</td> </tr> <tr> <td>3/4"   1/2"</td> <td>ME690-6-8</td> </tr> <tr> <td>3/4"   5/8"</td> <td>ME690-6-10</td> </tr> </tbody> </table> | MNPT X M. FLARE  | Part No.        | 3/4"   3/8" | ME690-6-6   | 3/4"   1/2" | ME690-6-8   | 3/4"   5/8" | ME690-6-10  |            |
| MNPT X M. FLARE  | Part No.  |   |   |   |  |                 |             |             |             |             |             |             |            |
| 3/4"   3/8"  | ME690-6-6   |   |   |   |  |                 |             |             |             |             |             |             |            |
| 3/4"   1/2"  | ME690-6-8   |   |   |   |  |                 |             |             |             |             |             |             |            |
| 3/4"   5/8"  | ME690-6-10  |   |   |   |  |                 |             |             |             |             |             |             |            |
| 800,000  | 20 Feet   | 1/2" OD<br>copper tubing<br>@ 10 PSI  | <b>1ST STAGE</b><br><br>Compact<br><b>MEGR-1122H-AAJ</b> 1/4" x 1/2"<br><b>MEGR-1222H-BGF</b> F. POL x 1/2"<br><b>MEGR-1222H-BGJ</b> 1/2" x 3/4"       | <br><b>1/4" X POL</b>   Length   Part No.<br>3/8" tube OD   12"   ME1689-12<br>1/4" tube OD   12"   ME1669-12<br>1/4" tube OD   6"   ME1669-06  | <br><table border="1"> <thead> <tr> <th>MNPT X M. FLARE</th> <th>Part No.</th> </tr> </thead> <tbody> <tr> <td>1/2"   3/8"</td> <td>ME690-4-6</td> </tr> <tr> <td>1/2"   1/2"</td> <td>ME690-4-8</td> </tr> <tr> <td>1/2"   5/8"</td> <td>ME690-4-10</td> </tr> </tbody> </table>                 | MNPT X M. FLARE | Part No.    | 1/2"   3/8" | ME690-4-6   | 1/2"   1/2" | ME690-4-8   | 1/2"   5/8" | ME690-4-10 |
|  | MNPT X M. FLARE   | Part No.  |   |   |  |                 |             |             |             |             |             |             |            |
|  | 1/2"   3/8"   | ME690-4-6   |   |   |  |                 |             |             |             |             |             |             |            |
| 1/2"   1/2"  | ME690-4-8   |   |   |   |  |                 |             |             |             |             |             |             |            |
| 1/2"   5/8"  | ME690-4-10  |   |   |   |  |                 |             |             |             |             |             |             |            |
| 70 Feet  | 5/8" OD<br>copper tubing<br>@ 10 PSI  | <b>2ND STAGE</b><br><br>Full Size - Straight Outlet<br><b>MEGR-1622-CFF</b> 1/2" x 3/4"<br><b>MEGR-1622-DFD</b> 3/4" x 3/4"  | <br><b>POL X POL</b>   Length   Part No.<br>3/8" tube OD   12"   ME1680-12<br>1/4" tube OD   12"   ME1664-12<br>3/8" tube OD   6"   ME1680-06       | <table border="1"> <thead> <tr> <th>MNPT X M. FLARE</th> <th>Part No.</th> </tr> </thead> <tbody> <tr> <td>1/2"   3/8"</td> <td>ME690-4-6</td> </tr> <tr> <td>1/2"   1/2"</td> <td>ME690-4-8</td> </tr> <tr> <td>1/2"   5/8"</td> <td>ME690-4-10</td> </tr> </tbody> </table> | MNPT X M. FLARE  | Part No.        | 1/2"   3/8" | ME690-4-6   | 1/2"   1/2" | ME690-4-8   | 1/2"   5/8" | ME690-4-10  |            |
| MNPT X M. FLARE  | Part No.  |   |   |   |  |                 |             |             |             |             |             |             |            |
| 1/2"   3/8"  | ME690-4-6   |   |   |   |  |                 |             |             |             |             |             |             |            |
| 1/2"   1/2"  | ME690-4-8   |   |   |   |  |                 |             |             |             |             |             |             |            |
| 1/2"   5/8"  | ME690-4-10  |   |   |   |  |                 |             |             |             |             |             |             |            |
| 600 Feet   | 3/4" IPS<br>iron pipe<br>@ 10 PSI   | Backmounts<br><b>MEGR-1652-CFF</b> 1/2" x 3/4"<br><b>MEGR-1652-DFD</b> 3/4" x 3/4"  | <br><b>POL X POL</b>   Length   Part No.<br>3/8" tube OD   12"   ME1680-12<br>1/4" tube OD   12"   ME1664-12<br>3/8" tube OD   6"   ME1680-06       | <table border="1"> <thead> <tr> <th>MNPT X M. FLARE</th> <th>Part No.</th> </tr> </thead> <tbody> <tr> <td>3/4"   3/8"</td> <td>ME690-6-6</td> </tr> <tr> <td>3/4"   1/2"</td> <td>ME690-6-8</td> </tr> <tr> <td>3/4"   5/8"</td> <td>ME690-6-10</td> </tr> </tbody> </table> | MNPT X M. FLARE  | Part No.        | 3/4"   3/8" | ME690-6-6   | 3/4"   1/2" | ME690-6-8   | 3/4"   5/8" | ME690-6-10  |            |
| MNPT X M. FLARE  | Part No.  |   |   |   |  |                 |             |             |             |             |             |             |            |
| 3/4"   3/8"  | ME690-6-6   |   |   |   |  |                 |             |             |             |             |             |             |            |
| 3/4"   1/2"  | ME690-6-8   |   |   |   |  |                 |             |             |             |             |             |             |            |
| 3/4"   5/8"  | ME690-6-10  |   |   |   |  |                 |             |             |             |             |             |             |            |
| 1,000,000  | 10 Feet   | 1/2" CTS<br>iron pipe or copper<br>tubing @ 10 PSI  | <b>1ST STAGE</b><br><br>Full Size<br><b>MEGR-1222H-BGJ</b> 1/2" x 3/4"<br><b>MEGR-1622H-HGJ</b> F. POL x 1/2"<br><b>MEGR-1622H-JGJ</b> F. POL x 3/4" | <br><b>1/4" X POL</b>   Length   Part No.<br>3/8" tube OD   12"   ME1680-12<br>1/4" tube OD   12"   ME1664-12<br>3/8" tube OD   6"   ME1680-06  | <br><table border="1"> <thead> <tr> <th>MNPT X M. FLARE</th> <th>Part No.</th> </tr> </thead> <tbody> <tr> <td>3/4"   3/8"</td> <td>ME690-6-6</td> </tr> <tr> <td>3/4"   1/2"</td> <td>ME690-6-8</td> </tr> <tr> <td>3/4"   5/8"</td> <td>ME690-6-10</td> </tr> </tbody> </table>               | MNPT X M. FLARE | Part No.    | 3/4"   3/8" | ME690-6-6   | 3/4"   1/2" | ME690-6-8   | 3/4"   5/8" | ME690-6-10 |
|  | MNPT X M. FLARE   | Part No.  |   |   |  |                 |             |             |             |             |             |             |            |
|  | 3/4"   3/8"   | ME690-6-6   |   |   |  |                 |             |             |             |             |             |             |            |
| 3/4"   1/2"  | ME690-6-8   |   |   |   |  |                 |             |             |             |             |             |             |            |
| 3/4"   5/8"  | ME690-6-10  |   |   |   |  |                 |             |             |             |             |             |             |            |
| 50 Feet  | 5/8" OD<br>copper tubing<br>@ 10 PSI  | <b>2ND STAGE</b><br><br>Full Size - Straight Outlet<br><b>MEGR-1622-DFD</b> 3/4" x 3/4"<br>Backmounts<br><b>MEGR-1652-DFD</b> 3/4" x 3/4"  | <br><b>POL X POL</b>   Length   Part No.<br>3/8" tube OD   12"   ME1680-12<br>1/4" tube OD   12"   ME1664-12<br>3/8" tube OD   6"   ME1680-06       | <table border="1"> <thead> <tr> <th>MNPT X M. FLARE</th> <th>Part No.</th> </tr> </thead> <tbody> <tr> <td>3/4"   3/8"</td> <td>ME690-6-6</td> </tr> <tr> <td>3/4"   1/2"</td> <td>ME690-6-8</td> </tr> <tr> <td>3/4"   5/8"</td> <td>ME690-6-10</td> </tr> </tbody> </table> | MNPT X M. FLARE  | Part No.        | 3/4"   3/8" | ME690-6-6   | 3/4"   1/2" | ME690-6-8   | 3/4"   5/8" | ME690-6-10  |            |
| MNPT X M. FLARE  | Part No.  |   |   |   |  |                 |             |             |             |             |             |             |            |
| 3/4"   3/8"  | ME690-6-6   |   |   |   |  |                 |             |             |             |             |             |             |            |
| 3/4"   1/2"  | ME690-6-8   |   |   |   |  |                 |             |             |             |             |             |             |            |
| 3/4"   5/8"  | ME690-6-10  |   |   |   |  |                 |             |             |             |             |             |             |            |
| 400 Feet   | 3/4" IPS<br>iron pipe<br>@ 10 PSI   | Backmounts<br><b>MEGR-1652-DFD</b> 3/4" x 3/4"  | <br><b>POL X POL</b>   Length   Part No.<br>3/8" tube OD   12"   ME1680-12<br>1/4" tube OD   12"   ME1664-12<br>3/8" tube OD   6"   ME1680-06       | <table border="1"> <thead> <tr> <th>MNPT X M. FLARE</th> <th>Part No.</th> </tr> </thead> <tbody> <tr> <td>3/4"   3/8"</td> <td>ME690-6-6</td> </tr> <tr> <td>3/4"   1/2"</td> <td>ME690-6-8</td> </tr> <tr> <td>3/4"   5/8"</td> <td>ME690-6-10</td> </tr> </tbody> </table> | MNPT X M. FLARE  | Part No.        | 3/4"   3/8" | ME690-6-6   | 3/4"   1/2" | ME690-6-8   | 3/4"   5/8" | ME690-6-10  |            |
| MNPT X M. FLARE  | Part No.  |   |   |   |  |                 |             |             |             |             |             |             |            |
| 3/4"   3/8"  | ME690-6-6   |   |   |   |  |                 |             |             |             |             |             |             |            |
| 3/4"   1/2"  | ME690-6-8   |   |   |   |  |                 |             |             |             |             |             |             |            |
| 3/4"   5/8"  | ME690-6-10  |   |   |   |  |                 |             |             |             |             |             |             |            |
| 2,000,000  | 10 Feet   | 5/8" copper<br>tubing<br>@ 10 PSI   | <b>1ST STAGE</b><br><br>Full Size<br><b>MEGR-1622H-JGJ</b> F. POL x 3/4"   | <br><b>POL X POL</b>   Length   Part No.<br>3/8" tube OD   12"   ME1680-12<br>1/4" tube OD   12"   ME1664-12<br>3/8" tube OD   6"   ME1680-06   | <br><table border="1"> <thead> <tr> <th>MNPT X M. FLARE</th> <th>Part No.</th> </tr> </thead> <tbody> <tr> <td>3/4"   3/8"</td> <td>ME690-6-6</td> </tr> <tr> <td>3/4"   1/2"</td> <td>ME690-6-8</td> </tr> <tr> <td>3/4"   5/8"</td> <td>ME690-6-10</td> </tr> </tbody> </table>               | MNPT X M. FLARE | Part No.    | 3/4"   3/8" | ME690-6-6   | 3/4"   1/2" | ME690-6-8   | 3/4"   5/8" | ME690-6-10 |
|  | MNPT X M. FLARE   | Part No.  |   |   |  |                 |             |             |             |             |             |             |            |
| 3/4"   3/8"  | ME690-6-6   |   |   |   |  |                 |             |             |             |             |             |             |            |
| 3/4"   1/2"  | ME690-6-8   |   |   |   |  |                 |             |             |             |             |             |             |            |
| 3/4"   5/8"  | ME690-6-10  |   |   |   |  |                 |             |             |             |             |             |             |            |
| 100 Feet   | 3/4" IPS<br>iron pipe<br>@ 10 PSI   | <b>2ND STAGE</b><br><br><b>MEGR-1HSRL-BFC</b><br>3/4" x 3/4"<br>Straight Outlet  | <br><b>POL X POL</b>   Length   Part No.<br>3/8" tube OD   12"   ME1680-12<br>1/4" tube OD   12"   ME1664-12<br>3/8" tube OD   6"   ME1680-06       | <table border="1"> <thead> <tr> <th>MNPT X M. FLARE</th> <th>Part No.</th> </tr> </thead> <tbody> <tr> <td>3/4"   3/8"</td> <td>ME690-6-6</td> </tr> <tr> <td>3/4"   1/2"</td> <td>ME690-6-8</td> </tr> <tr> <td>3/4"   5/8"</td> <td>ME690-6-10</td> </tr> </tbody> </table> | MNPT X M. FLARE  | Part No.        | 3/4"   3/8" | ME690-6-6   | 3/4"   1/2" | ME690-6-8   | 3/4"   5/8" | ME690-6-10  |            |
| MNPT X M. FLARE  | Part No.  |   |   |   |  |                 |             |             |             |             |             |             |            |
| 3/4"   3/8"  | ME690-6-6   |   |   |   |  |                 |             |             |             |             |             |             |            |
| 3/4"   1/2"  | ME690-6-8   |   |   |   |  |                 |             |             |             |             |             |             |            |
| 3/4"   5/8"  | ME690-6-10  |   |   |   |  |                 |             |             |             |             |             |             |            |
| 2,500,000  | 80 Feet   | 3/4" IPS<br>iron pipe<br>@ 10 PSI   | <b>1ST STAGE</b><br><br><b>MEGR-1627/7710</b><br>1" x 1"   | <br><b>2ND STAGE</b><br><br><b>MEGR-CS1200IR6EC6</b><br>1-1/4" x 1-1/4"                               |  |                 |             |             |             |             |             |             |            |
|  | 225 Feet  | 1" iron pipe<br>@ 10 PSI  | <br><b>MEGR-1627/7710</b><br>1" x 1"   | <br><b>MEGR-CS1200IR6EC6</b><br>1-1/4" x 1-1/4"   |  |                 |             |             |             |             |             |             |            |



# DOMESTIC - FIRST STAGE

## COMPACT MODELS

These first stage regulators are used to reduce LP gas tank pressures for a second stage regulator (normally 10 PSIG). All MEC first stage regulators are red indicating high outlet pressure. Compact First stage regulator vents have 3/8" FNPT tapped ports and E-Z Grip screens located over the outlet. The MEGR-1222H series offers optimal relief performance that well exceeds UL test requirements providing double failure overpressure protection when used with MEC MEGR-1622, MEGR-1642 & MEGR-1652 Series Second Stage regulators. All MEC **Excelsa-Flo™** domestic regulators feature a 25 year recommended replacement life and our exclusive 3 part tear away leak check adhesive sticker.

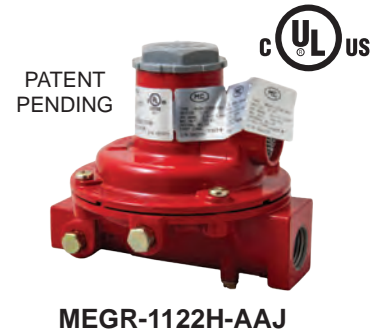

**MEGR-1122H Series:** Offers a compact first stage regulator design perfect for tight applications such as underground tank domes. They feature an adjustment range from 9-12 PSIG (factory set @ 10 PSIG), stainless steel internal components, fluorocarbon (FKM) seat discs, molded lip fabric reinforced diaphragms and large aluminum precision machined orifice to minimize freeze ups while providing superior downstream regulation and maximum corrosion resistance against weather or contaminated gas.

**MEGR-1222H Series:** Offers a compact first stage regulator design perfect for tight applications such as underground tank domes. They feature an adjustment range from 9-12 PSIG (factory set @ 10 PSIG), stainless steel internal components, fluorocarbon (FKM) seat discs, molded lip fabric reinforced diaphragms and large aluminum precision machined orifice to minimize freeze ups while providing superior downstream regulation and maximum corrosion resistance against weather or contaminated gas.

- F. POL inlet version features NEW patent pending anti-freeze heat transfer fins

### SPECIFICATIONS

**Type:** First Stage

**Max. Inlet Pressure:** 250 PSIG

**Exterior Finish:** Red Powder Coat

**Interior Finish:** Red Powder Coat

**Orifice Size:** 0.15"

**Diaphragm:** Fabric Reinforced NBR Molded Lip O-Ring  
Bonnet/Body Seal

**Relief Type:** Internal Relief - Spring Loaded

**Bonnet / Body Material:** Die Cast Aluminum

**Seat Material:** Fluorocarbon (FKM)

**Listings:** cUL<sub>US</sub> / UL 144

**Mounting Holes:** Standard 3-1/2" Center

**Pressure Taps:** #54 Orifice 1/8" FNPT Plugged (2)

**Relief Travel Stop:** Molded in Adjustment Cap - Grey

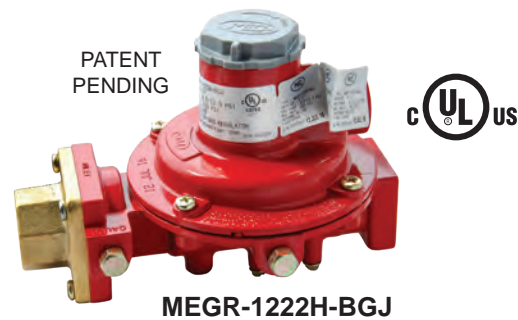
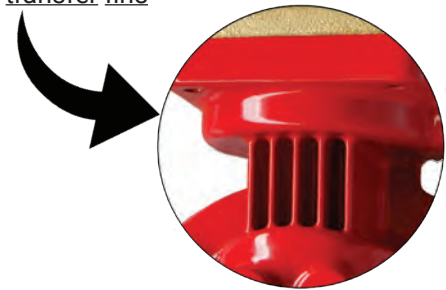

| Part No.                        | Capacity in BTU/H LPG <sup>(1)</sup> | Inlet     | Outlet    | Vent Port | Outlet Adj. Range (PSI) | Outlet Set Point (PSI) |
|---------------------------------|--------------------------------------|-----------|-----------|-----------|-------------------------|------------------------|
| MEGR-1122H-AAJ                  | 1,000,000                            | 1/4" FNPT | 1/2" FNPT | 3/8" FNPT | 8-12                    | 10                     |
| MEGR-1122H-AAJXA <sup>(2)</sup> | 1,000,000                            | 1/4" FNPT | 1/2" FNPT | 3/8" FNPT | 8-12                    | 10                     |
| MEGR-1122H-AAJXB <sup>(3)</sup> | 1,000,000                            | 1/4" FNPT | 1/2" FNPT | 3/8" FNPT | 8-12                    | 10                     |
| MEGR-1222H-BGF                  | 1,000,000                            | F. POL    | 1/2" FNPT | 3/8" FNPT | 9-12                    | 10                     |
| MEGR-1222H-BGFXA <sup>(2)</sup> | 1,000,000                            | F. POL    | 1/2" FNPT | 3/8" FNPT | 9-12                    | 10                     |
| MEGR-1222H-BGFXB <sup>(3)</sup> | 1,000,000                            | F. POL    | 1/2" FNPT | 3/8" FNPT | 9-12                    | 10                     |
| MEGR-1222H-BGJ                  | 1,700,000                            | F. POL    | 3/4" FNPT | 3/8" FNPT | 9-12                    | 10                     |
| MEGR-1222H-BGJXA <sup>(2)</sup> | 1,700,000                            | F. POL    | 3/4" FNPT | 3/8" FNPT | 9-12                    | 10                     |

(1) Based on 30 PSIG Inlet pressure and 20% droop

(2) Indicates regulator vent opposite pressure tap ports

(3) Indicates regulator vent over pressure taps



# DOMESTIC - FIRST STAGE

## COMPACT BACK MOUNT

These first stage regulators are used to reduce LP gas tank pressures for a second stage regulator (normally 10 PSIG). All MEC first stage regulators are red indicating high outlet pressure. Compact First stage regulator vents have 3/8" FNPT tapped ports and E-Z Grip screens located over the outlet. The MEGR-1222H series offers optimal relief performance that well exceeds UL test requirements providing double failure overpressure protection when used with MEC MEGR-1622, MEGR-1642 & MEGR-1652 Series Second Stage regulators. All MEC **Excelsa-Flo™** domestic regulators feature a 25 year recommended replacement life and our exclusive 3 part tear away leak check adhesive sticker.

- F. POL outlet version features NEW patent pending anti-freeze heat transfer fins



MEGR-1252H-BGFXA w/ flexible riser



LEFT IMAGE: MEGR-1252H-BGFXA w/ ME690 Dielectric Union

### SPECIFICATIONS

**Type:** First Stage

**Max. Inlet Pressure:** 250 PSIG

**Exterior Finish:** Red Powder Coat

**Interior Finish:** Red Powder Coat

**Orifice Size:** 0.17

**Diaphragm:** Fabric Reinforced NBR Molded Lip O-Ring Bonnet/Body Seal

**Relief Type:** Internal Relief - Spring Loaded

**Bonnet / Body Material:** Die Cast Aluminum

**Seat Material:** Fluorocarbon (FKM)

**Listings:** cUL<sub>US</sub> / UL 144

**Mounting Holes:** Standard 3-1/2" Center

**Pressure Taps:** #54 Orifice, 1/8" FNPT, Plugged (2)

**Relief Travel Stop:** Molded in Adjustment Cap - Grey

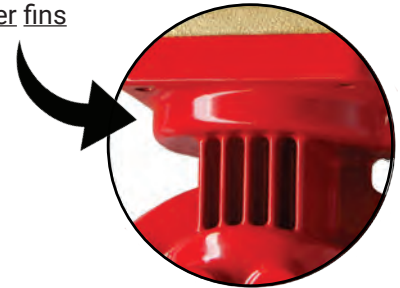

The MEGR-1252H Series offers a compact first stage regulator design perfect for tight applications such as underground tank domes. They feature an adjustment range from 9-12 PSIG (factory set @ 10 PSIG), stainless steel internal components, fluorocarbon (FKM) seat discs, molded lip fabric reinforced diaphragms and large aluminum precision machined orifice to minimize freeze ups while providing superior downstream regulation and maximum corrosion resistance against weather or contaminated gas. With the outlet located 90 degrees from the inlet this configuration is perfectly oriented to exit the protective shroud of both above and below ground tanks without additional elbow fittings or connections. The "XA" model locates the pressure tap ports opposite the vent so that the regulator can be mounted horizontally for easy access and proper downward positioning of the vent opening.

| Part No.                        | Capacity in BTU/H LPG <sup>(1)</sup> | Inlet  | Outlet    | Outlet Adj. Range (PSI) | Outlet Set Point (PSI) |
|---------------------------------|--------------------------------------|--------|-----------|-------------------------|------------------------|
| MEGR-1252H-BGF                  | 1,400,000                            | F. POL | 1/2" FNPT | 9-12                    | 10                     |
| MEGR-1252H-BGFXA <sup>(2)</sup> | 1,400,000                            | F. POL | 1/2" FNPT | 9-12                    | 10                     |
| MEGR-1252H-BGJ                  | 1,500,000                            | F. POL | 3/4" FNPT | 9-12                    | 10                     |
| MEGR-1252H-BGJXA <sup>(2)</sup> | 1,500,000                            | F. POL | 3/4" FNPT | 9-12                    | 10                     |

(1) Based on 30 PSIG Inlet pressure and 20% droop

(2) Indicates vent orientation opposite pressure taps



Tested in the U.S.A

## FULL SIZE MODELS

These first stage regulators are used to reduce LP gas tank pressures for a second stage regulator (normally 10 PSIG). All MEC first stage regulators are red indicating high outlet pressure. First stage full size regulator vents have 3/4" FNPT tapped ports and E-Z Grip screens located over the outlet. Both the MEGR-1122H and the MEGR-1622H series offer optimal relief performance that exceeds UL test requirements providing double failure overpressure protection when used with MEC MEGR-1622 & MEGR-1652 series second stage regulators. All MEC **Excelsa-Flo™** domestic regulators feature a 25 year recommended replacement life and the MEC exclusive tear away leak check adhesive sticker.

**MEGR-1622H Series:** Offers all of the same features as the compact MEGR-1122H Series in a full size version. Our full size MEGR-1622H Series has a large fabric reinforced diaphragm for superior downstream regulation, heavy duty wrench flats, and a large 3/4" FNPT tapped drip lip vent to help prevent relief vent blockage.

### SPECIFICATIONS

**Type:** First Stage

**Max. Inlet Pressure:** 250 PSIG

**Exterior Finish:** Red Powder Coat

**Interior Finish:** Red Powder Coat

**Orifice Size:** 0.219"

**Diaphragm:** Fabric Reinforced NBR Molded Lip O-Ring  
Bonnet/Body Seal

**Relief Type:** Internal Relief - Spring Loaded

**Bonnet / Body Material:** Die Cast Aluminum

**Seat Material:** Fluorocarbon (FKM)

**Listings:** cUL<sub>US</sub> / UL 144

**Mounting Holes:** Standard 3-1/2" Center

**Pressure Taps:** #54 Orifice, 1/8" FNPT, Plugged (2)

**Relief Travel Stop:** Molded in Adjustment Cap - Black



Tested in the  
U.S.A

PATENT PENDING



PATENT PENDING



| Part No.       | Capacity in BTU/H LPG <sup>(1)</sup> | Inlet     | Outlet    | Vent Port | Outlet Adj. Range (PSI) | Outlet Set Point (PSI) |
|----------------|--------------------------------------|-----------|-----------|-----------|-------------------------|------------------------|
| MEGR-1622H-BGJ | 2,200,000                            | 1/2" FNPT | 1/2" FNPT | 3/4" FNPT | 8-12                    | 10                     |
| MEGR-1622H-DGJ | 2,500,000                            | 3/4" FNPT | 3/4" FNPT | 3/4" FNPT | 8-12                    | 10                     |
| MEGR-1622H-HGJ | 2,300,000                            | F. POL    | 1/2" FNPT | 3/4" FNPT | 8-12                    | 10                     |
| MEGR-1622H-JGJ | 2,750,000                            | F. POL    | 3/4" FNPT | 3/4" FNPT | 8-12                    | 10                     |

(1) Based on 30 PSIG Inlet pressure and 20% droop



# DOMESTIC - FIRST STAGE

## 5 PSI OUTLET PRESSURE

These first stage regulators are used to reduce LP gas tank pressures for a second stage regulator (5 PSIG). All MEC first stage regulators are red indicating high outlet pressure. First stage regulator vents have 3/4" FNPT tapped ports and E-Z Grip screens located over the outlet. The MEGR-1622H series offer optimal relief performance that well exceeds UL test requirements providing double failure overpressure protection when used with MEC MEGR-1622, MEGR-1642 & MEGR-1652 Series Second Stage regulators. All MEC **Excelsa-Flo™** domestic regulators feature a 25 year recommended replacement life and our exclusive tear away leak check adhesive sticker.



| Part No.       | Type      | Capacity in BTU/H LPG <sup>(1)</sup> | Inlet     | Outlet    | Outlet Adj. Range (PSI) | Outlet Set Point (PSI) |
|----------------|-----------|--------------------------------------|-----------|-----------|-------------------------|------------------------|
| MEGR-1622H-BGK | Full Size | 2,100,000                            | 1/2" FNPT | 1/2" FNPT | 4-6                     | 5                      |
| MEGR-1622H-HGK | Full Size | 2,200,000                            | F. POL    | 1/2" FNPT | 4-6                     | 5                      |
| MEGR-1622H-JGK | Full Size | 2,650,000                            | F. POL    | 3/4" FNPT | 4-6                     | 5                      |



(1) Based on 30 PSIG inlet pressure and 20% droop.

## FEMALE POL TEE INLET

These first stage F. POL tee inlet regulators are used to reduce LP gas tank pressures for a second stage regulator (normally 10 PSIG) in a multiple tank manifold installation without adapters or tees. All MEC first stage regulators are red indicating high outlet pressure. Compact First stage regulator vents have 3/8" FNPT tapped ports and E-Z Grip screens located over the outlet. The MEGR-1222HT series offers optimal relief performance that well exceeds UL test requirements providing double failure overpressure protection when used with MEC MEGR-1622, MEGR-1642 & MEGR-1652 Series Second Stage regulators. All MEC **Excelsa-Flo™** domestic regulators feature a 25 year recommended replacement life and our exclusive tear away leak check adhesive sticker.



**MEGR-1222HT**  
Compact Tee Inlet Series

### SPECIFICATIONS

- Type:** First Stage
- Max. Inlet Pressure:** 250 PSIG
- Exterior Finish:** Red Powder Coat
- Interior Finish:** Red Powder Coat
- Orifice Size:** 0.15" (Compact) & 0.219" Full
- Diaphragm:** Fabric Reinforced NBR Molded Lip O-Ring Bonnet/Body Seal
- Relief Type:** Internal Relief - Spring Loaded
- Bonnet / Body Material:** Die Cast Aluminum
- Seat Material:** Fluorocarbon (FKM)
- Listings:** cUL<sub>US</sub> / UL 144
- Mounting Holes:** Standard 3-1/2" Center
- Pressure Taps:** #54 Orifice 1/8" FNPT Plugged (2)
- Relief Travel Stop:** Molded in Adjustment Cap -  
Gray (Compact), Black (Full Size)













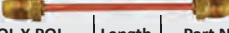







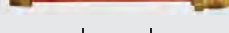







| Part No.        | Type    | Capacity in BTU/H LPG <sup>(1)</sup> | Inlet      | Outlet    | Outlet Adj. Range (PSI) | Outlet Set Point (PSI) |
|-----------------|---------|--------------------------------------|------------|-----------|-------------------------|------------------------|
| MEGR-1222HT-BGF | Compact | 1,000,000                            | F. POL/Tee | 1/2" FNPT | 8-12                    | 10                     |
| MEGR-1622HT-HGJ | Full    | 2,300,000                            | F. POL/Tee | 1/2" FNPT | 8-12                    | 10                     |
| MEGR-1622HT-JGJ | Full    | 2,750,000                            | F. POL/Tee | 3/4" FNPT | 8-12                    | 10                     |

(1) Based on 30 PSIG Inlet pressure and 20% droop



# DOMESTIC - SECOND STAGE

## SENTINEL™ DIELECTRIC INLET REFERENCE GUIDE

| LOAD<br>BTU/HR.  | DISTANCE<br>Maximum distance<br>from 1st stage<br>regulator to<br>2nd stage regulator  | PIPE SIZE<br>Between 1st<br>and 2nd Stage<br>Regulator   | MEC REGULATOR  | MEC PIGTAILS  |   |   |   |   |   |   |   |           |              |              |           |           |
|--|--|--|--|---|---|---|---|---|---|---|---|-----------|--------------|--------------|-----------|-----------|
| 400,000  | 80 Feet  | 1/2" CTS iron pipe<br>or<br>1/2" OD copper tubing<br>@ 10 PSI  | <b>1ST STAGE</b><br>Compact<br><b>MEGR-1122H-AAJ</b> 1/4" x 1/2"<br><b>MEGR-1222H-BGF</b> F. POL x 1/2"    | <br><table border="1"> <thead> <tr> <th>1/4" X POL</th> <th>Length</th> <th>Part No.</th> </tr> </thead> <tbody> <tr> <td>3/8" tube OD</td> <td>12"</td> <td>ME1689-12</td> </tr> <tr> <td>1/4" tube OD</td> <td>12"</td> <td>ME1669-12</td> </tr> <tr> <td>1/4" tube OD</td> <td>6"</td> <td>ME1669-06</td> </tr> </tbody> </table>   | 1/4" X POL                                | Length                                    | Part No.                                  | 3/8" tube OD                            | 12"                                     | ME1689-12                               | 1/4" tube OD                              | 12"       | ME1669-12    | 1/4" tube OD | 6"        | ME1669-06 |
|  |  |  | 1/4" X POL   | Length  | Part No.                                  |   |   |   |   |   |   |           |              |              |           |           |
| 3/8" tube OD   | 12"  | ME1689-12  |  |   |   |   |   |   |   |   |   |           |              |              |           |           |
| 1/4" tube OD   | 12"  | ME1669-12  |  |   |   |   |   |   |   |   |   |           |              |              |           |           |
| 1/4" tube OD   | 6"   | ME1669-06  |  |   |   |   |   |   |   |   |   |           |              |              |           |           |
| <b>2ND STAGE</b><br>Compact<br><b>MEGR-1222D-BAF</b> 1/2" x 1/2"<br><b>MEGR-1222D-CFF</b> 1/2" x 3/4"<br>Backmounts<br><b>MEGR-1252D-BAF</b> 1/2" x 1/2"<br><b>MEGR-1252D-CFF</b> 1/2" x 3/4"    | <br><table border="1"> <thead> <tr> <th>POL X POL</th> <th>Length</th> <th>Part No.</th> </tr> </thead> <tbody> <tr> <td>3/8" tube OD</td> <td>12"</td> <td>ME1680-12</td> </tr> <tr> <td>1/4" tube OD</td> <td>12"</td> <td>ME1664-12</td> </tr> <tr> <td>3/8" tube OD</td> <td>6"</td> <td>ME1680-06</td> </tr> </tbody> </table> | POL X POL  | Length   | Part No.  | 3/8" tube OD                              | 12"                                       | ME1680-12                                 | 1/4" tube OD                            | 12"                                     | ME1664-12                               | 3/8" tube OD                              | 6"        | ME1680-06    |              |           |           |
| POL X POL  | Length   | Part No.   |  |   |   |   |   |   |   |   |   |           |              |              |           |           |
| 3/8" tube OD   | 12"  | ME1680-12  |  |   |   |   |   |   |   |   |   |           |              |              |           |           |
| 1/4" tube OD   | 12"  | ME1664-12  |  |   |   |   |   |   |   |   |   |           |              |              |           |           |
| 3/8" tube OD   | 6"   | ME1680-06  |  |   |   |   |   |   |   |   |   |           |              |              |           |           |
| 600,000  | 40 Feet  | 1/2" CTS iron pipe<br>or<br>1/2" OD copper tubing<br>@ 10 PSI  | <b>1ST STAGE</b><br>Compact<br><b>MEGR-1122H-AAJ</b> 1/4" x 1/2"<br><b>MEGR-1222H-BGF</b> F. POL x 1/2"<br><b>MEGR-1222H-BGJ</b> F. POL x 3/4"   | <br><table border="1"> <thead> <tr> <th>1/4" X POL</th> <th>Length</th> <th>Part No.</th> </tr> </thead> <tbody> <tr> <td>3/8" tube OD</td> <td>12"</td> <td>ME1689-12</td> </tr> <tr> <td>1/4" tube OD</td> <td>12"</td> <td>ME1669-12</td> </tr> <tr> <td>1/4" tube OD</td> <td>6"</td> <td>ME1669-06</td> </tr> </tbody> </table>   | 1/4" X POL                                | Length                                    | Part No.                                  | 3/8" tube OD                            | 12"                                     | ME1689-12                               | 1/4" tube OD                              | 12"       | ME1669-12    | 1/4" tube OD | 6"        | ME1669-06 |
|  | 1/4" X POL   | Length   | Part No.   |   |   |   |   |   |   |   |   |           |              |              |           |           |
|  | 3/8" tube OD   | 12"  | ME1689-12  |   |   |   |   |   |   |   |   |           |              |              |           |           |
| 1/4" tube OD   | 12"  | ME1669-12  |  |   |   |   |   |   |   |   |   |           |              |              |           |           |
| 1/4" tube OD   | 6"   | ME1669-06  |  |   |   |   |   |   |   |   |   |           |              |              |           |           |
| 100 Feet   | 5/8" OD<br>copper tubing<br>@ 10 PSI   | <b>2ND STAGE</b><br>Compact<br><b>MEGR-1222D-BAF</b> 1/2" x 1/2"<br><b>MEGR-1222D-CFF</b> 1/2" x 3/4"<br><b>MEGR-1222D-DF</b> 3/4" x 3/4"<br>Backmounts<br><b>MEGR-1252D-BAF</b> 1/2" x 1/2"<br><b>MEGR-1252D-CFF</b> 1/2" x 3/4"<br><b>MEGR-1252D-DF</b> 3/4" x 3/4"  | <br><table border="1"> <thead> <tr> <th>POL X POL</th> <th>Length</th> <th>Part No.</th> </tr> </thead> <tbody> <tr> <td>3/8" tube OD</td> <td>12"</td> <td>ME1680-12</td> </tr> <tr> <td>1/4" tube OD</td> <td>12"</td> <td>ME1664-12</td> </tr> <tr> <td>3/8" tube OD</td> <td>6"</td> <td>ME1680-06</td> </tr> </tbody> </table>   | POL X POL   | Length                                    | Part No.                                  | 3/8" tube OD                              | 12"                                     | ME1680-12                               | 1/4" tube OD                            | 12"                                       | ME1664-12 | 3/8" tube OD | 6"           | ME1680-06 |           |
| POL X POL  | Length   | Part No.   |  |   |   |   |   |   |   |   |   |           |              |              |           |           |
| 3/8" tube OD   | 12"  | ME1680-12  |  |   |   |   |   |   |   |   |   |           |              |              |           |           |
| 1/4" tube OD   | 12"  | ME1664-12  |  |   |   |   |   |   |   |   |   |           |              |              |           |           |
| 3/8" tube OD   | 6"   | ME1680-06  |  |   |   |   |   |   |   |   |   |           |              |              |           |           |
| 1,000 Feet   | 3/4" IPS<br>iron pipe<br>@ 10 PSI  | <b>2ND STAGE</b><br>Full Size - Straight Outlet<br><b>MEGR-1622D-CFF</b> 1/2" x 3/4"<br><b>MEGR-1622D-DF</b> 3/4" x 3/4"<br>Backmounts<br><b>MEGR-1652D-CFF</b> 1/2" x 3/4"<br><b>MEGR-1652D-DF</b> 3/4" x 3/4"    | <br><table border="1"> <thead> <tr> <th>POL X POL</th> <th>Length</th> <th>Part No.</th> </tr> </thead> <tbody> <tr> <td>3/8" tube OD</td> <td>12"</td> <td>ME1680-12</td> </tr> <tr> <td>1/4" tube OD</td> <td>12"</td> <td>ME1664-12</td> </tr> <tr> <td>3/8" tube OD</td> <td>6"</td> <td>ME1680-06</td> </tr> </tbody> </table> | POL X POL   | Length                                    | Part No.                                  | 3/8" tube OD                              | 12"                                     | ME1680-12                               | 1/4" tube OD                            | 12"                                       | ME1664-12 | 3/8" tube OD | 6"           | ME1680-06 |           |
| POL X POL  | Length   | Part No.   |  |   |   |   |   |   |   |   |   |           |              |              |           |           |
| 3/8" tube OD   | 12"  | ME1680-12  |  |   |   |   |   |   |   |   |   |           |              |              |           |           |
| 1/4" tube OD   | 12"  | ME1664-12  |  |   |   |   |   |   |   |   |   |           |              |              |           |           |
| 3/8" tube OD   | 6"   | ME1680-06  |  |   |   |   |   |   |   |   |   |           |              |              |           |           |
| 800,000  | 20 Feet  | 1/2" OD<br>copper tubing<br>@ 10 PSI   | <b>1ST STAGE</b><br>Compact<br><b>MEGR-1122H-AAJ</b> 1/4" x 1/2"<br><b>MEGR-1222H-BGF</b> F. POL x 1/2"<br><b>MEGR-1222H-BGJ</b> F. POL x 3/4"   | <br><table border="1"> <thead> <tr> <th>1/4" X POL</th> <th>Length</th> <th>Part No.</th> </tr> </thead> <tbody> <tr> <td>3/8" tube OD</td> <td>12"</td> <td>ME1689-12</td> </tr> <tr> <td>1/4" tube OD</td> <td>12"</td> <td>ME1669-12</td> </tr> <tr> <td>1/4" tube OD</td> <td>6"</td> <td>ME1669-06</td> </tr> </tbody> </table> | 1/4" X POL                                | Length                                    | Part No.                                  | 3/8" tube OD                            | 12"                                     | ME1689-12                               | 1/4" tube OD                              | 12"       | ME1669-12    | 1/4" tube OD | 6"        | ME1669-06 |
|  | 1/4" X POL   | Length   | Part No.   |   |   |   |   |   |   |   |   |           |              |              |           |           |
|  | 3/8" tube OD   | 12"  | ME1689-12  |   |   |   |   |   |   |   |   |           |              |              |           |           |
| 1/4" tube OD   | 12"  | ME1669-12  |  |   |   |   |   |   |   |   |   |           |              |              |           |           |
| 1/4" tube OD   | 6"   | ME1669-06  |  |   |   |   |   |   |   |   |   |           |              |              |           |           |
| 70 Feet  | 5/8" OD<br>copper tubing<br>@ 10 PSI   | <b>2ND STAGE</b><br>Full Size - Straight Outlet<br><b>MEGR-1622D-CFF</b> 1/2" x 3/4"<br><b>MEGR-1622D-DF</b> 3/4" x 3/4"<br>Backmounts<br><b>MEGR-1652D-CFF</b> 1/2" x 3/4"<br><b>MEGR-1652D-DF</b> 3/4" x 3/4"    | <br><table border="1"> <thead> <tr> <th>POL X POL</th> <th>Length</th> <th>Part No.</th> </tr> </thead> <tbody> <tr> <td>3/8" tube OD</td> <td>12"</td> <td>ME1680-12</td> </tr> <tr> <td>1/4" tube OD</td> <td>12"</td> <td>ME1664-12</td> </tr> <tr> <td>3/8" tube OD</td> <td>6"</td> <td>ME1680-06</td> </tr> </tbody> </table> | POL X POL   | Length                                    | Part No.                                  | 3/8" tube OD                              | 12"                                     | ME1680-12                               | 1/4" tube OD                            | 12"                                       | ME1664-12 | 3/8" tube OD | 6"           | ME1680-06 |           |
| POL X POL  | Length   | Part No.   |  |   |   |   |   |   |   |   |   |           |              |              |           |           |
| 3/8" tube OD   | 12"  | ME1680-12  |  |   |   |   |   |   |   |   |   |           |              |              |           |           |
| 1/4" tube OD   | 12"  | ME1664-12  |  |   |   |   |   |   |   |   |   |           |              |              |           |           |
| 3/8" tube OD   | 6"   | ME1680-06  |  |   |   |   |   |   |   |   |   |           |              |              |           |           |
| 600 Feet   | 3/4" IPS<br>iron pipe<br>@ 10 PSI  | <b>2ND STAGE</b><br>Full Size - Straight Outlet<br><b>MEGR-1622D-CFF</b> 1/2" x 3/4"<br><b>MEGR-1622D-DF</b> 3/4" x 3/4"<br>Backmounts<br><b>MEGR-1652D-CFF</b> 1/2" x 3/4"<br><b>MEGR-1652D-DF</b> 3/4" x 3/4"    | <br><table border="1"> <thead> <tr> <th>POL X POL</th> <th>Length</th> <th>Part No.</th> </tr> </thead> <tbody> <tr> <td>3/8" tube OD</td> <td>12"</td> <td>ME1680-12</td> </tr> <tr> <td>1/4" tube OD</td> <td>12"</td> <td>ME1664-12</td> </tr> <tr> <td>3/8" tube OD</td> <td>6"</td> <td>ME1680-06</td> </tr> </tbody> </table> | POL X POL   | Length                                    | Part No.                                  | 3/8" tube OD                              | 12"                                     | ME1680-12                               | 1/4" tube OD                            | 12"                                       | ME1664-12 | 3/8" tube OD | 6"           | ME1680-06 |           |
| POL X POL  | Length   | Part No.   |  |   |   |   |   |   |   |   |   |           |              |              |           |           |
| 3/8" tube OD   | 12"  | ME1680-12  |  |   |   |   |   |   |   |   |   |           |              |              |           |           |
| 1/4" tube OD   | 12"  | ME1664-12  |  |   |   |   |   |   |   |   |   |           |              |              |           |           |
| 3/8" tube OD   | 6"   | ME1680-06  |  |   |   |   |   |   |   |   |   |           |              |              |           |           |
| 1,000,000  | 10 Feet  | 1/2" CTS iron pipe<br>or<br>copper tubing<br>@ 10 PSI  | <b>1ST STAGE</b><br>Compact<br><b>MEGR-1222H-BGJ</b> F. POL x 3/4"<br>Full Size<br><b>MEGR-1622H-HGJ</b> F. POL x 1/2"<br><b>MEGR-1622H-JGJ</b> F. POL x 3/4"   | <br><table border="1"> <thead> <tr> <th>POL X POL</th> <th>Length</th> <th>Part No.</th> </tr> </thead> <tbody> <tr> <td>3/8" tube OD</td> <td>12"</td> <td>ME1680-12</td> </tr> <tr> <td>1/4" tube OD</td> <td>12"</td> <td>ME1664-12</td> </tr> <tr> <td>3/8" tube OD</td> <td>6"</td> <td>ME1680-06</td> </tr> </tbody> </table>                          | POL X POL                                 | Length                                    | Part No.                                  | 3/8" tube OD                            | 12"                                     | ME1680-12                               | 1/4" tube OD                              | 12"       | ME1664-12    | 3/8" tube OD | 6"        | ME1680-06 |
|  | POL X POL  | Length   | Part No.   |   |   |   |   |   |   |   |   |           |              |              |           |           |
|  | 3/8" tube OD   | 12"  | ME1680-12  |   |   |   |   |   |   |   |   |           |              |              |           |           |
| 1/4" tube OD   | 12"  | ME1664-12  |  |   |   |   |   |   |   |   |   |           |              |              |           |           |
| 3/8" tube OD   | 6"   | ME1680-06  |  |   |   |   |   |   |   |   |   |           |              |              |           |           |
| 50 Feet  | 5/8" OD<br>copper tubing<br>@ 10 PSI   | <b>2ND STAGE</b><br>Full Size - Straight Outlet<br><b>MEGR-1622D-DF</b> 3/4" x 3/4"<br>Backmounts<br><b>MEGR-1652D-DF</b> 3/4" x 3/4"    | <br><table border="1"> <thead> <tr> <th>POL X POL</th> <th>Length</th> <th>Part No.</th> </tr> </thead> <tbody> <tr> <td>3/8" tube OD</td> <td>12"</td> <td>ME1680-12</td> </tr> <tr> <td>1/4" tube OD</td> <td>12"</td> <td>ME1664-12</td> </tr> <tr> <td>3/8" tube OD</td> <td>6"</td> <td>ME1680-06</td> </tr> </tbody> </table> | POL X POL   | Length                                    | Part No.                                  | 3/8" tube OD                              | 12"                                     | ME1680-12                               | 1/4" tube OD                            | 12"                                       | ME1664-12 | 3/8" tube OD | 6"           | ME1680-06 |           |
| POL X POL  | Length   | Part No.   |  |   |   |   |   |   |   |   |   |           |              |              |           |           |
| 3/8" tube OD   | 12"  | ME1680-12  |  |   |   |   |   |   |   |   |   |           |              |              |           |           |
| 1/4" tube OD   | 12"  | ME1664-12  |  |   |   |   |   |   |   |   |   |           |              |              |           |           |
| 3/8" tube OD   | 6"   | ME1680-06  |  |   |   |   |   |   |   |   |   |           |              |              |           |           |
| 400 Feet   | 3/4" IPS<br>iron pipe<br>@ 10 PSI  | <b>2ND STAGE</b><br>Full Size - Straight Outlet<br><b>MEGR-1622D-DF</b> 3/4" x 3/4"<br>Backmounts<br><b>MEGR-1652D-DF</b> 3/4" x 3/4"    | <br><table border="1"> <thead> <tr> <th>POL X POL</th> <th>Length</th> <th>Part No.</th> </tr> </thead> <tbody> <tr> <td>3/8" tube OD</td> <td>12"</td> <td>ME1680-12</td> </tr> <tr> <td>1/4" tube OD</td> <td>12"</td> <td>ME1664-12</td> </tr> <tr> <td>3/8" tube OD</td> <td>6"</td> <td>ME1680-06</td> </tr> </tbody> </table> | POL X POL   | Length                                    | Part No.                                  | 3/8" tube OD                              | 12"                                     | ME1680-12                               | 1/4" tube OD                            | 12"                                       | ME1664-12 | 3/8" tube OD | 6"           | ME1680-06 |           |
| POL X POL  | Length   | Part No.   |  |   |   |   |   |   |   |   |   |           |              |              |           |           |
| 3/8" tube OD   | 12"  | ME1680-12  |  |   |   |   |   |   |   |   |   |           |              |              |           |           |
| 1/4" tube OD   | 12"  | ME1664-12  |  |   |   |   |   |   |   |   |   |           |              |              |           |           |
| 3/8" tube OD   | 6"   | ME1680-06  |  |   |   |   |   |   |   |   |   |           |              |              |           |           |
|        |  |  |  |   |   |   |   |   |   |   |   |           |              |              |           |           |
| <table border="0"> <tr> <td><b>MEGR-1122H</b><br/>MAX BTU/H: 1,000,000</td> <td><b>MEGR-1222H</b><br/>MAX BTU/H: 1,700,000</td> <td><b>MEGR-1622H</b><br/>MAX BTU/H: 2,750,000</td> <td><b>MEGR-1222D</b><br/>MAX BTU/H: 800,000</td> <td><b>MEGR-1252D</b><br/>MAX BTU/H: 650,000</td> <td><b>MEGR-1642D</b><br/>MAX BTU/H: 900,000</td> <td><b>MEGR-1652D</b><br/>MAX BTU/H: 1,000,000</td> </tr> </table>   |  |  |  |   | <b>MEGR-1122H</b><br>MAX BTU/H: 1,000,000 | <b>MEGR-1222H</b><br>MAX BTU/H: 1,700,000 | <b>MEGR-1622H</b><br>MAX BTU/H: 2,750,000 | <b>MEGR-1222D</b><br>MAX BTU/H: 800,000 | <b>MEGR-1252D</b><br>MAX BTU/H: 650,000 | <b>MEGR-1642D</b><br>MAX BTU/H: 900,000 | <b>MEGR-1652D</b><br>MAX BTU/H: 1,000,000 |           |              |              |           |           |
| <b>MEGR-1122H</b><br>MAX BTU/H: 1,000,000  | <b>MEGR-1222H</b><br>MAX BTU/H: 1,700,000  | <b>MEGR-1622H</b><br>MAX BTU/H: 2,750,000  | <b>MEGR-1222D</b><br>MAX BTU/H: 800,000  | <b>MEGR-1252D</b><br>MAX BTU/H: 650,000   | <b>MEGR-1642D</b><br>MAX BTU/H: 900,000   | <b>MEGR-1652D</b><br>MAX BTU/H: 1,000,000 |   |   |   |   |   |           |              |              |           |           |

# DOMESTIC - SECOND STAGE

## SENTINEL™ DIELECTRIC INLET

PATENT PENDING



MEGR-1222D/MEGR-1622D  
Compact/Full Size Series

PATENT PENDING



MEGR-1252D  
Compact Back Mount

PATENT PENDING



MEGR-1642D  
Full Size Series

PATENT PENDING



MEGR-1652D  
Back Mount Series

**SENTINEL™** Series Second Stage Dielectric Regulators are used to reduce outlet pressures from first stage regulators (normally 10 PSI) to 11" WC in domestic installations. All MEC **SENTINEL™** Series second stage regulators are green with yellow inlet connections indicating low outlet pressure and dielectric separation. Second stage regulator vents have FNPT drip lip tapped ports and our exclusive E-Z grip screens located over the inlet. All MEC **SENTINEL™** Series second stage domestic regulators feature an all stainless steel inlet filter screen to reduce debris from passing through the regulator. Both the MEGR-1622D and the MEGR-1652D Series regulators offer optimal relief performance that well exceeds UL test requirements providing double failure overpressure protection (no more than 2 PSI downstream pressure) when used with MEGR-1122H, MEGR-1222H and MEGR-1622H Series First Stage regulators. All MEC **Excelsa-Flo™** domestic regulators feature a 25 year recommended replacement life and our exclusive tear away leak check adhesive sticker.

**SENTINEL™** Series Second Stage Dielectric Regulators feature an integral dielectric inlet connection designed to isolate upstream metallic piping from electrical current prior to piping entering a building in compliance with NFPA 58 – 2020 section 6.11.3.17. Since the FNPT inlet serves as the dielectric separation media, any standard MNPT threaded connector or valve can be installed without a separate dielectric union. Both compact and full size models feature the same basic footprint measurement from inlet to outlet, as all standard **Excelsa-Flo™** second stage regulators, making it ideal for regulator change-outs.

**MEGR-1622D & MEGR-1652D Series** feature inlet and outlets that are inline, while the MEGR-1252D and MEGR-1652D offer a convenient rear back mount discharge outlet. The MEGR-1642D Series offers a side discharge located 90 degrees from the inlet making it ideal for installations with horizontal piping including those with vapor metering systems.

### SPECIFICATIONS

- Type:** Second Stage
- Max. Inlet Pressure:** 10 PSIG
- Exterior Finish:** Green Powder Coat Body and Yellow Powder Coat Inlet
- Interior Finish:** Green Powder Coat
- Orifice Size:** Compact - .14" (BAF), 0.17" (CFF & DFF) / Full - 0.219"
- Diaphragm:** Fabric Reinforced (NBR) Molded Lip O-Ring Bonnet/Body Seal
- Relief Type:** Internal Relief - Spring Loaded
- Bonnet / Body Material:** Die Cast Aluminum
- Seat Material:** Fluorocarbon (FKM)
- Listings:** cUL<sub>US</sub> / UL 144
- Mounting Holes:** Standard 3-1/2" Center
- Pressure Taps:** #54 Orifice 1/8" FNPT Plugged (2)
- Relief Travel Stop:** Molded In Adjustment Cap - Black (Full Size), Gray (Compact)



| Part No.                      | Type                 | Capacity in BTU/H LPG <sup>(1)</sup> | Inlet     | Outlet    | Outlet Adj. Range ("WC) | Outlet Set Point ("WC) |
|-------------------------------|----------------------|--------------------------------------|-----------|-----------|-------------------------|------------------------|
| MEGR-1222D-BAF                | Compact              | 500,000                              | 1/2" FNPT | 1/2" FNPT | 9.5-13                  | 11                     |
| MEGR-1222D-CFF                | Compact              | 800,000                              | 1/2" FNPT | 3/4" FNPT | 9.5-13                  | 11                     |
| MEGR-1222D-DFF                | Compact              | 800,000                              | 3/4" FNPT | 3/4" FNPT | 9.5-13                  | 11                     |
| MEGR-1252D-BAF <sup>(2)</sup> | Compact Back Mount   | 450,000                              | 1/2" FNPT | 1/2" FNPT | 9.5-13                  | 11                     |
| MEGR-1252D-CFF <sup>(2)</sup> | Compact Back Mount   | 650,000                              | 1/2" FNPT | 3/4" FNPT | 9.5-13                  | 11                     |
| MEGR-1252D-DFF <sup>(2)</sup> | Compact Back Mount   | 700,000                              | 3/4" FNPT | 3/4" FNPT | 9.5-13                  | 11                     |
| MEGR-1622D-BCF                | Full Size            | 710,000                              | 1/2" FNPT | 1/2" FNPT | 9-13                    | 11                     |
| MEGR-1622D-CFF                | Full Size            | 1,300,000                            | 1/2" FNPT | 3/4" FNPT | 9-13                    | 11                     |
| MEGR-1622D-DFF                | Full Size            | 1,300,000                            | 3/4" FNPT | 3/4" FNPT | 9-13                    | 11                     |
| MEGR-1642D-DFF <sup>(3)</sup> | Full Size            | 900,000                              | 3/4" FNPT | 3/4" FNPT | 9-13                    | 11                     |
| MEGR-1652D-CFF <sup>(2)</sup> | Full Size Back Mount | 1,000,000                            | 1/2" FNPT | 3/4" FNPT | 9-13                    | 11                     |
| MEGR-1652D-DFF <sup>(2)</sup> | Full Size Back Mount | 1,000,000                            | 3/4" FNPT | 3/4" FNPT | 9-13                    | 11                     |

(1) Based on 10 PSIG inlet pressure and 20% droop (2) Indicates back mount configuration  
(3) Indicates side discharge configuration

# COMPACT MODELS

These compact second stage regulators are used to reduce outlet pressures from first stage regulators (normally 10 PSIG) to 11" WC in domestic installations. All MEC second stage regulators are green indicating low outlet pressure. Compact second stage regulator vents have 3/8" FNPT tapped ports and our exclusive E-Z grip screens located over the inlet. All MEC second stage domestic regulators feature a stainless steel inlet filter screen to reduce debris from passing through the regulator. All MEC **Excelsa-Flo™** domestic regulators feature a 25 year recommended replacement life and our exclusive 3-part tear away leak check adhesive sticker.

PATENT PENDING



MEGR-1222 Series

**MEGR-1222 & MEGR-1252 Series:** Offers a compact second stage regulator design perfect for lower to intermediate BTU applications. They feature an adjustable range from 9.5-13" WC (factory set @ 11" WC), stainless steel internal components, fluorocarbon (FKM) seat discs, molded lip fabric reinforced diaphragms and large aluminum precision machined orifices providing superior downstream regulation and maximum corrosion resistance against weather or contaminated gas. The MEGR-1222 Series have both the inlet and outlet in line where the MEGR-1252 series have a rear discharge back mount outlet for convenient wall mount applications.

- NEW patent pending anti-freeze heat transfer fins

## SPECIFICATIONS

- Type:** Second Stage
- Max. Inlet Pressure:** 10 PSIG
- Exterior Finish:** Green Powder Coat
- Interior Finish:** Green Powder Coat
- Orifice Size:** 0.14" (BAF), 0.17" (CFF & DFF)
- Diaphragm:** Fabric Reinforced (NBR) Molded Lip O-Ring
- Bonnet Body Seal**
- Relief Type:** Internal Relief - Spring Loaded
- Bonnet / Body Material:** Die Cast Aluminum
- Seat Material:** Fluorocarbon (FKM)
- Listings:** / UL 144
- Mounting Holes:** Standard 3-1/2" Center
- Pressure Taps:** #54 Orifice 1/8" FNPT Plugged (2)
- Relief Travel Stop:** Molded In Adjustment Cap - Gray

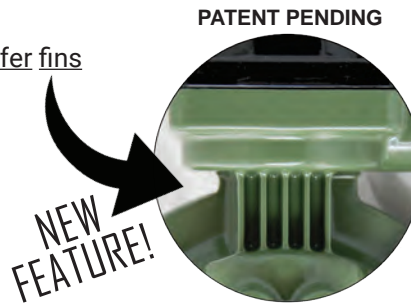

MEGR-1252 Back Mount



| Part No.                     | Type       | Capacity in BTU/H LPG <sup>(1)</sup> | Inlet     | Outlet    | Outlet Adj. Range ("WC) | Outlet Set Point ("WC) |
|------------------------------|------------|--------------------------------------|-----------|-----------|-------------------------|------------------------|
| MEGR-1222-BAF                | Top Mount  | 500,000                              | 1/2" FNPT | 1/2" FNPT | 9.5-13                  | 11                     |
| MEGR-1222-CFF                | Top Mount  | 800,000                              | 1/2" FNPT | 3/4" FNPT | 9.5-13                  | 11                     |
| MEGR-1222-DFF                | Top Mount  | 800,000                              | 3/4" FNPT | 3/4" FNPT | 9.5-13                  | 11                     |
| MEGR-1252-BAF <sup>(2)</sup> | Back Mount | 450,000                              | 1/2" FNPT | 1/2" FNPT | 9.5-13                  | 11                     |
| MEGR-1252-CFF <sup>(2)</sup> | Back Mount | 650,000                              | 1/2" FNPT | 3/4" FNPT | 9.5-13                  | 11                     |
| MEGR-1252-DFF <sup>(2)</sup> | Back Mount | 700,000                              | 3/4" FNPT | 3/4" FNPT | 9.5-13                  | 11                     |

(1) Based on 10 PSIG inlet pressure and 20% droop  
 (2) Indicates back mount configuration  
 (3) Indicates vent over outlet



# DOMESTIC - SECOND STAGE

## FULL SIZE MODELS

These second stage regulators are used to reduce outlet pressures from first stage regulators (normally 10 PSI) to 11" WC in domestic installations. All MEC second stage regulators are green indicating low outlet pressure. Second stage full size regulator vents have 3/4" FNPT tapped ports and our exclusive E-Z grip screens located over the inlet. All MEC second stage domestic regulators feature a stainless steel inlet filter screen to reduce debris from passing through the regulator. Both the MEGR-1622 and the MEGR-1652 Series offer optimal relief performance that exceeds UL test requirements providing double failure overpressure protection (no more than 2 PSI downstream pressure) when used with MEGR-1122H and MEGR-1622H Series First Stage regulators. All MEC **Excelsa-Flo™** domestic regulators feature a 25 year recommended replacement life and our exclusive tear away leak check adhesive sticker.

### MEGR-1622 & MEGR-1652 Series:

Offers all of the same features as the compact MEGR-1122 Series but in a full size, high capacity version. Our full size second stage regulators have a large fabric reinforced diaphragm for superior downstream regulation, heavy duty wrench flats, and a large 3/4" FNPT tapped drip lip vent to help prevent relief valve blockage. The MEGR-1622 Series have both the inlet and outlet in line where the MEGR-1652 series have a rear discharge back mount outlet for convenient wall mount applications.

### SPECIFICATIONS

- Type:** Second Stage
- Max. Inlet Pressure:** 10 PSIG
- Exterior Finish:** Green Powder Coat
- Interior Finish:** Green Powder Coat
- Orifice Size:** 0.219"
- Diaphragm:** Fabric Reinforced (NBR) Molded Lip O-Ring
- Bonnet Body Seal**
- Relief Type:** Internal Relief - Spring Loaded
- Bonnet / Body Material:** Die Cast Aluminum
- Seat Material:** Fluorocarbon (FKM)
- Listings:** cUL<sub>us</sub> / UL 144
- Mounting Holes:** Standard 3-1/2" Center
- Pressure Taps:** #54 Orifice 1/8" FNPT Plugged (2)
- Relief Travel Stop:** Molded In Adjustment Cap - Black

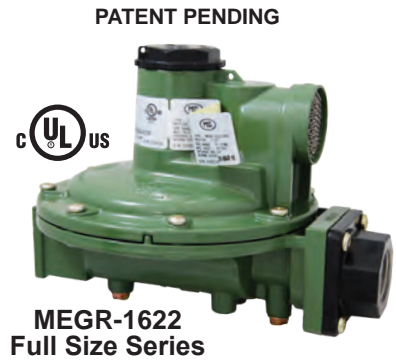

| Part No.                       | Type       | Capacity in BTU/H LPG <sup>(1)</sup> | Inlet     | Outlet    | Outlet Adj. Range ("WC) | Outlet Set Point ("WC) |
|--------------------------------|------------|--------------------------------------|-----------|-----------|-------------------------|------------------------|
| MEGR-1622-BCF                  | Top Mount  | 710,000                              | 1/2" FNPT | 1/2" FNPT | 9-13                    | 11                     |
| MEGR-1622-CFF                  | Top Mount  | 1,300,000                            | 1/2" FNPT | 3/4" FNPT | 9-13                    | 11                     |
| MEGR-1622-CFFXO <sup>(3)</sup> | Top Mount  | 1,300,000                            | 1/2" FNPT | 3/4" FNPT | 9-13                    | 11                     |
| MEGR-1622-DFF                  | Top Mount  | 1,300,000                            | 3/4" FNPT | 3/4" FNPT | 9-13                    | 11                     |
| MEGR-1622-DFFXO <sup>(3)</sup> | Top Mount  | 1,300,000                            | 3/4" FNPT | 3/4" FNPT | 9-13                    | 11                     |
| MEGR-1652-CFF <sup>(2)</sup>   | Back Mount | 1,000,000                            | 1/2" FNPT | 3/4" FNPT | 9-13                    | 11                     |
| MEGR-1652-DFF <sup>(2)</sup>   | Back Mount | 1,000,000                            | 3/4" FNPT | 3/4" FNPT | 9-13                    | 11                     |

- (1) Based on 10 PSIG inlet pressure and 20% droop
- (2) Indicates back mount configuration
- (3) Indicates vent over outlet



# FULL SIZE 12-24" WC

## MEGR-1622-DFG & MEGR-1652-DFG Series:

These second stage regulators are used to reduce outlet pressures from first stage regulators (normally 10 PSI) to a range of 12-24" WC in domestic installations. The elevated outlet pressure range allows the use of these regulator models in applications where something above 11" WC (normal outlet pressure) but below 2 PSI (2 PSI system pressure) is desired. Some appliances, burners, generators and similar high demand applications operate ideally at pressures above typical domestic regulator (nominal 11" WC) outlet pressures.

All MEC second stage regulators are green indicating low outlet pressure. Second stage full size regulator vents have 3/4" FNPT tapped ports and our exclusive E-Z grip screens located over the inlet. All MEC second stage domestic regulators feature an internal stainless steel inlet filter screen to reduce debris from passing through the regulator. Both the MEGR-1622 and the MEGR-1652 Series offer optimal relief performance providing double failure overpressure protection (no more than 2 PSI downstream pressure) when used with MEGR-1122H and MEGR-1622H Series First Stage regulators. All MEC **Excelsa-Flo™** domestic regulators feature a 25 year recommended replacement life and our exclusive 3-part tear away leak check adhesive sticker.



MEGR-1622-DFG

MEC full size second stage regulators have a large fabric reinforced diaphragm for superior downstream regulation, heavy duty wrench flats, and a large 3/4" FNPT tapped drip lip vent to help prevent relief valve blockage. The MEGR-1622 Series have both the inlet and outlet in line where the MEGR-1652 series have a rear discharge back mount outlet for convenient wall mount applications.

### SPECIFICATIONS

- Type:** Second Stage / Full Size
- Max. Inlet Pressure:** 10 PSIG
- Exterior Finish:** Green Powder Coat
- Interior Finish:** Green Powder Coat
- Orifice Size:** 0.219
- Diaphragm:** Fabric Reinforced (NBR) Molded Lip  
O-Ring Bonnet/Body Seal
- Relief Type:** Internal Relief - Spring Loaded
- Bonnet / Body Material:** Die Cast Aluminum
- Seat Material:** Fluorocarbon (FKM)
- Mounting Holes:** Standard 3-1/2" Center
- Pressure Taps:** #54 Orifice 1/8" FNPT Plugged (2)
- Relief Travel Stop:** Molded In Adjustment Cap: Black



MEGR-1652-DFG

| Part No.                     | Type       | Maximum Capacity in BTU/H LPG <sup>(1)</sup> | Inlet     | Outlet    | Outlet Adj. Range ("WC) | Outlet Set Point ("WC) |
|------------------------------|------------|--|-----------|-----------|-------------------------|------------------------|
| MEGR-1622-DFG                | Inline     | 1,500,000                                    | 3/4" FNPT | 3/4" FNPT | 12-24                   | 18                     |
| MEGR-1652-DFG <sup>(2)</sup> | Back Mount | 1,200,000                                    |           |           |                         | 18                     |

(1) Based on 10 PSIG inlet pressure and 25% droop  
 (2) Indicates back mount configuration

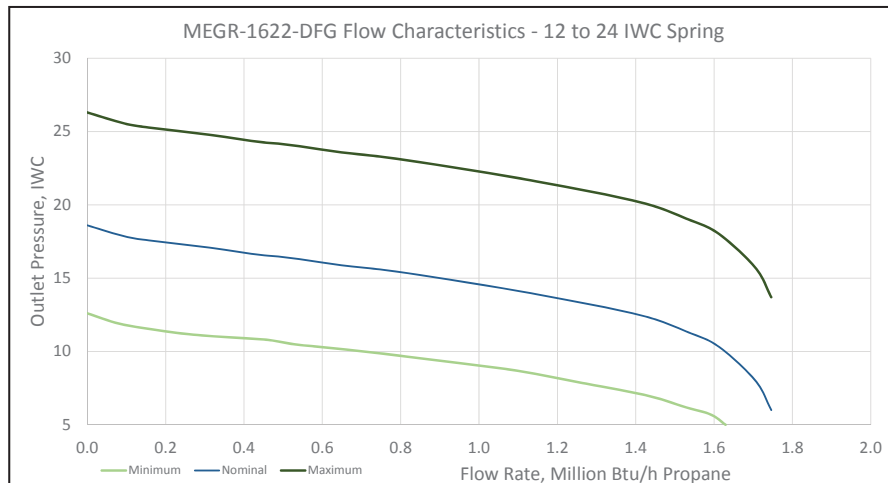

# DOMESTIC - SECOND STAGE

## SIDE OUTLET

These second stage regulators are used to reduce outlet pressures from first stage regulators (normally 10 PSI) to 11" WC in domestic installations. All MEC second stage regulators are green indicating low outlet pressure. Second stage regulator vents have 3/4" FNPT tapped ports and our exclusive E-Z grip screens located over the inlet. All MEC second stage domestic regulators feature a stainless steel inlet filter screen to reduce debris from passing through the regulator. The MEGR-1642 Series offers optimal relief performance that well exceeds UL test requirements providing double failure overpressure protection (no more than 2 PSI downstream pressure) when used with MEGR-1122H, MEGR-1222H and MEGR-1622H Series First Stage regulators. All MEC **Excelsa-Flo™** domestic regulators feature a 25 year recommended replacement life and our exclusive tear away leak check adhesive sticker.

**MEGR-1642 Series:** Features an adjustable range from 9-13" WC (factory set @ 11" WC), stainless steel internal components, fluorocarbon (FKM) seat discs, molded lip fabric reinforced diaphragms and large aluminum precision machined orifices providing superior downstream regulation and maximum corrosion resistance against weather or contaminated gas.

Our full size second stage regulators have a large fabric reinforced diaphragm for superior downstream regulation, heavy duty wrench flats, and a large 3/4" FNPT tapped drip lip vent to help prevent relief valve blockage. The MEGR-1642 Series has the outlet at 90 degrees from the inlet making it ideal for vapor meter installations.

### SPECIFICATIONS

**Type:** Second Stage

**Max. Inlet Pressure:** 10 PSIG

**Exterior Finish:** Green Powder Coat

**Interior Finish:** Green Powder Coat

**Orifice Size:** 0.219" (Full)

**Diaphragm:** Fabric Reinforced (NBR) Molded Lip O-Ring Bonnet / Body Seal

**Relief Type:** Internal Relief - Spring Loaded

**Bonnet / Body Material:** Die Cast Aluminum

**Seat Material:** Fluorocarbon (FKM)

**Listings:** cUL<sub>US</sub> / UL 144

**Mounting Holes:** Standard 3-1/2" Center

**Pressure Taps:** #54 Orifice 1/8" FNPT Plugged (2)

**Relief Travel Stop:** Molded In Adjustment Cap - Black

PATENT PENDING



**MEGR-1642-DFF**

| MEC Excelsa-Flo™ Second Stage Domestic Regulators |                       |                                      |           |           |                         |                        |
|---|-----------------------|--------------------------------------|-----------|-----------|-------------------------|------------------------|
| Part No.  | Type                  | Capacity in BTU/H LPG <sup>(1)</sup> | Inlet     | Outlet    | Outlet Adj. Range ("WC) | Outlet Set Point ("WC) |
| MEGR-1642-DFF                                     | Full Size Side Outlet | 900,000                              | 3/4" FNPT | 3/4" FNPT | 9-13                    | 11                     |

(1) Based on 10 PSIG inlet pressure and 20% droop



Tested in the U.S.A

# HIGH CAPACITY - SECOND STAGE LIGHT COMMERCIAL

The MEGR-1622C Series Light Commercial Regulators feature higher output capacity and are designed to reduce outlet pressures from first stage regulators (normally 10 PSI) to 11" WC (Black Cap) or 18" WC (yellow cap), in light commercial/industrial applications. All MEC second stage regulators are green indicating low output pressure with MEGR-1622C units featuring higher output 12"-24" WC range indicated with yellow bonnet adjustment cap. Second stage full size regulator vents have 3/4" FNPT tapped ports and our exclusive E-Z grip screen located over the inlet. The MEGR-1622C Series regulators feature a stainless steel inlet filter screen to reduce debris from passing through the regulator and affecting sealing performance. The MEGR-1622C Series regulators also offer optimal relief performance that exceeds UL test requirements providing double failure overpressure protection (no more than 2 PSI downstream pressure) when utilized in conjunction with MEC MEGR-1122H or MEGR-1622H Series first stage regulators. All MEC **Excela-Flo™** Regulators feature a 25 year recommended replacement life and our exclusive 3 part tear away adhesive leak check sticker.

## SPECIFICATIONS

- Type:** Adjustable / Inches WC
- Max. Inlet Pressure:** 10 PSIG
- Exterior Finish:** Green Powder Coat
- Interior Finish:** Green Powder Coat
- Orifice Size:** 0.264"
- Diaphragm:** Fabric Reinforced (NBR) Molded Lip O-Ring  
Bonnet Body Seal
- Relief Type:** Internal Relief - Spring Loaded
- Bonnet / Body Material:** Die Cast Aluminum
- Seat Material:** Fluorocarbon (FKM)
- Listings:** cULus / UL 144
- Mounting Holes:** Standard 3-1/2" Center
- Pressure Taps:** #54 Orifice 1/8" FNPT Plugged (2)
- Relief Travel Stop:** Molded In Adjustment Cap -  
Black (9-13" WC), Yellow (12-24" WC)



**MEGR-1622C-DGF**

9-13" WC



**MEGR-1622C-GGG**

12-24" WC



| Part No.       | Capacity in BTU/H LPG @ 8.8" WC Outlet Pressure | Capacity in BTU/H LPG @ 13" WC Set Point and 8.8" WC Outlet Pressure | Inlet     | Outlet  | Outlet Adj. Range ("WC) | Outlet Set Point ("WC) |
|----------------|---|--|-----------|---------|-------------------------|------------------------|
| MEGR-1622C-DGF | 1,800,000                                       | 2,200,000  | 3/4" FNPT | 1" FNPT | 9-13                    | 11                     |
| MEGR-1622C-DGG | 2,500,000                                       | --   | 3/4" FNPT | 1" FNPT | 12-24                   | 18                     |
| MEGR-1622C-GGF | 1,800,000                                       | 2,200,000  | 1" FNPT   | 1" FNPT | 9-13                    | 11                     |
| MEGR-1622C-GGG | 2,500,000                                       | --   | 1" FNPT   | 1" FNPT | 12-24                   | 18                     |





# FULL SIZE REGULATOR ALTERNATE SPRING KITS

The MEP1600 Series alternate spring kits are designed to allow any MEC **Excelsa-Flo™** full size second stage or integral full size two-stage regulator to be adapted in the field for applications that require lower or higher output pressure than the standard 9-13" WC adjustment will permit. Each kit includes an alternate spring, new bonnet label showing the new spring range of adjustment, and a detailed set of installation instructions for performing the modification.



**MEP1600-24**  
12-24" WC Spring Kit

## SPECIFICATIONS

- Includes color coded spring, new bonnet label and installation instructions
- Alternate springs do not affect product warranty or recommended service life when installed in a new uninstalled regulator
- Can be used in conjunction with all full size second stage and integral two-stage Excelsa-flo regulators (MEGR-1622, 1642, 1652 and 1632 series)
- Greatly increases the versatility of all MEC full size second stage and integral two-stage regulators
- Can be used in LPG or Natural Gas applications
- Maximum inlet operating pressures remain unchanged for the regulator when MEP1600 alternate springs are installed

| Part No.   | Description   | Adjustment Range | Spring Color |
|------------|---|------------------|--------------|
| MEP1600-7  | <b>Excelsa-Flo™</b><br>Full Size Second Stage and<br>Full Size Integral Two-Stage<br>Alternate Spring Range Kit | 5-7" WC          | Red          |
| MEP1600-8  |   | 6-8" WC          | Blue         |
| MEP1600-12 |   | 8-12" WC         | Green        |
| MEP1600-24 |   | 12-24" WC        | Yellow       |

# UNIVERSAL REGULATOR BRACKET

Universal Slotted H Style Bracket for both full size and compact MEC **Excelsa-Flo™** domestic regulators

## FEATURES

- Anodized aluminum stamping for maximum strength and durability
- Slotted and elongated regulator mounting holes for quick, convenient and secure regulator retention
- Multiple screw holes for easy and reliable building/structure installation



MEGR-100C



Tested in the  
U.S.A

# DOMESTIC - SECOND STAGE

## SENTINEL™ 2 PSI DIELECTRIC INLET

**SENTINEL™** Series 2 PSI Second Stage Dielectric Regulators are used to reduce outlet pressures from first stage regulators (normally 10 PSI) to nominal 2 PSI in domestic installations. 2 PSI service regulators are used in conjunction with an LPG line regulator either at the indoor appliance or a remote manifold distribution header inlet. All MEC **SENTINEL™** 2 PSI Series second stage regulators are white with yellow inlet connections indicating 2 PSI outlet pressure and dielectric separation. 2 PSI service regulators have 3/4" FNPT tapped vents and our exclusive E-Z grip screens located over the inlet. All MEC **SENTINEL™** Series 2 PSI SERVICE regulators feature an all stainless steel inlet filter screen to reduce debris from passing through the regulator. Both the MEGR-1622ED and the MEGR-1652ED Series regulators offer optimal relief performance that well exceeds UL test requirements. All MEC **Excelsa-Flo™** domestic regulators feature a 25 year recommended replacement life and our exclusive tear away leak check adhesive sticker.

**SENTINEL™** Series 2 PSI Second Stage Dielectric Regulators feature an integral dielectric inlet connection designed to isolate upstream metallic piping from electrical current prior to piping entering a building in compliance with NFPA58 - 2017 section 6.11.316. Since the FNPT inlet serves as the dielectric separation media, any standard MNPT threaded connector or valve can be installed without a separate dielectric union. All models feature the same basic footprint measurement from inlet to outlet as standard **Excelsa-Flo™** Second Stage regulators, making it ideal for regulator change-outs.

PATENT PENDING

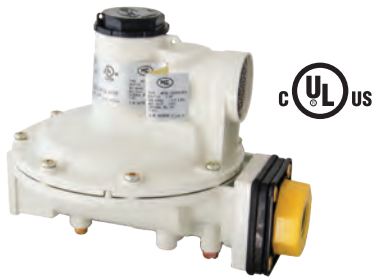

**MEGR-1622ED Series**  
features an inline inlet and outlet orientation.

PATENT PENDING



**MEGR-1652ED-DFH**  
Features a rear discharge back mount outlet for convenient wall mount applications.

### SPECIFICATIONS

- Type:** 2 PSI
- Max. Inlet Pressure:** 10 PSIG
- Exterior Finish:** White Coat Body and Yellow Powder Coat Inlet
- Interior Finish:** White Powder Coat
- Orifice Size:** 0.219"
- Diaphragm:** Fabric Reinforced (NBR) Molded Lip O-Ring Bonnet/Body Seal
- Relief Type:** Internal Relief - Spring Loaded
- Bonnet / Body Material:** Die Cast Aluminum
- Seat Material:** Fluorocarbon (FKM)
- Listings:** cUL<sub>US</sub> / UL 144
- Mounting Holes:** Standard 3-1/2" Center
- Pressure Taps:** #54 Orifice 1/8" FNPT Plugged (2)
- Relief Travel Stop:** Molded In Adjustment Cap - Black

| Part No.                       | Type                 | Capacity in BTU/H LPG <sup>(1)</sup> | Inlet     | Outlet    | Vent Port | Outlet Adj. Range (PSI) | Outlet Set Point (PSI) |
|--------------------------------|----------------------|--------------------------------------|-----------|-----------|-----------|-------------------------|------------------------|
| MEGR-1622ED-BCH                | Full Size            | 1,100,000                            | 1/2" FNPT | 1/2" FNPT | 3/4" FNPT | 1.0 - 2.2               | 2                      |
| MEGR-1622ED-DCH                | Full Size            | 1,400,000                            | 3/4" FNPT | 3/4" FNPT | 3/4" FNPT | 1.0 - 2.2               | 2                      |
| MEGR-1652ED-DFH <sup>(2)</sup> | Full Size Back Mount | 1,300,000                            | 3/4" FNPT | 3/4" FNPT | 3/4" FNPT | 1.0 - 2.2               | 2                      |

(1) Based on 10 PSIG inlet pressure and 20% droop  
(2) Indicates back mount configuration



# DOMESTIC - SECOND STAGE

## 2 PSI OUTLET

These 2 PSI service regulators are used to reduce outlet pressures from first stage regulators (normally 10 PSI) to a nominal 2 PSI. 2 PSI service regulators are used in conjunction with an LPG line regulator either at the indoor appliance or a remote manifold distribution header inlet. All MEC 2 PSI service regulators are white with black adjustment caps. The full size 2 PSI service regulators have 3/4" FNPT tapped vents and our exclusive E-Z grip screens located over the inlet. All MEC 2 PSI service regulators feature a stainless steel inlet filter screen to reduce debris from passing through the regulator. Both the MEGR-1622E and MEGR-1652E series offer optimal relief performance that exceeds UL test requirements. All MEC **Excela-Flo™** domestic regulators feature a 25 year recommended replacement life and our exclusive tear away leak check adhesive sticker.

### MEGR-1622E Series:

Offers a full size high capacity molded lip fabric reinforced diaphragm, stainless steel internal components, fluorocarbon (FKM) seat discs, precision machined aluminum orifices, and an adjustment range from 1.0-2.2 PSI (factory set @ 2 PSI) providing superior downstream regulation and maximum corrosion resistance against weather or contaminated gas.



### SPECIFICATIONS

- Type:** Second Stage 2 PSI
- Max. Inlet Pressure:** 10 PSI
- Exterior Finish:** White Powder Coat
- Interior Finish:** White Powder Coat
- Orifice Size:** 0.219"
- Seat Material:** Fluorocarbon (FKM)
- Diaphragm:** Fabric Reinforced (NBR) / Molded Lip O-Ring  
Bonnet/Body Seal
- Relief Type:** Internal Relief - Spring Loaded
- Bonnet / Body Material:** Die Cast Aluminum
- Listings:** cUL<sub>US</sub> / UL 144
- Mounting Holes:** Standard 3-1/2" Center
- Pressure Taps:** #54 Orifice, 1/8" FNPT, Plugged (2)
- Relief Travel Stop:** Molded in Adjustment Cap - Black



### MEGR-1652E Series:









Offers all of the same features as the MEGR-1622E Series but with a rear discharge back mount outlet for convenient wall mount applications.

| Part No.                      | Type                 | Capacity in BTU/H LPG <sup>(1)</sup> | Inlet     | Outlet    | Vent Port | Outlet Adj. Range (PSI) | Outlet Set Point (PSI) |
|-------------------------------|----------------------|--------------------------------------|-----------|-----------|-----------|-------------------------|------------------------|
| MEGR-1622E-BCH                | Full Size            | 1,100,000                            | 1/2" FNPT | 1/2" FNPT | 3/4" FNPT | 1.0-2.2                 | 2                      |
| MEGR-1622E-DCH                | Full Size            | 1,400,000                            | 3/4" FNPT | 3/4" FNPT | 3/4" FNPT | 1.0-2.2                 | 2                      |
| MEGR-1652E-DFH <sup>(2)</sup> | Full Size Back Mount | 1,300,000                            | 3/4" FNPT | 3/4" FNPT | 3/4" FNPT | 1.0-2.2                 | 2                      |

(1) Based on 10 PSIG inlet pressure and 20% droop.  
 (2) Indicates back mount configuration.



# DOMESTIC - INTEGRAL TWO STAGE REFERENCE GUIDE

| LOAD<br>BTU/HR. | DISTANCE<br>maximum distance<br>from regulator outlet to<br>furthest appliance | PIPE TO<br>APPLIANCE  | MEC REGULATOR  | MEC PIGTAILS   |  |           |           |              |              |           |              |              |           |              |              |           |
|-----------------|--|---|--|--|--|-----------|-----------|--------------|--------------|-----------|--------------|--------------|-----------|--------------|--------------|-----------|
| 100,000         | 10 Feet  | 1/2" CTS Iron Pipe or copper tubing @ 11" water column regulator set pressure         | <br>MEGR-1232-HBF F. POL X 1/2"<br>MEGR-1232-HFF F. POL X 3/4"<br>MEGR-1232-BBF 1/4" X 1/2"  | <table border="1"> <thead> <tr> <th>POL X POL</th> <th>Length</th> <th>Part. No.</th> </tr> </thead> <tbody> <tr> <td>3/8" tube OD</td> <td>12"</td> <td>ME1680-12</td> </tr> <tr> <td>1/4" tube OD</td> <td>12"</td> <td>ME1664-12</td> </tr> <tr> <td>3/8" tube OD</td> <td>6"</td> <td>ME1680-06</td> </tr> </tbody> </table> | POL X POL  | Length    | Part. No. | 3/8" tube OD | 12"          | ME1680-12 | 1/4" tube OD | 12"          | ME1664-12 | 3/8" tube OD | 6"           | ME1680-06 |
|                 | POL X POL  | Length  |  | Part. No.  |  |           |           |              |              |           |              |              |           |              |              |           |
|                 | 3/8" tube OD   | 12"   |  | ME1680-12  |  |           |           |              |              |           |              |              |           |              |              |           |
| 1/4" tube OD    | 12"  | ME1664-12   |  |  |  |           |           |              |              |           |              |              |           |              |              |           |
| 3/8" tube OD    | 6"   | ME1680-06   |  |  |  |           |           |              |              |           |              |              |           |              |              |           |
| 35 Feet         | 5/8" copper tubing @ 11" water column regulator set pressure                   |    |  |  |  |           |           |              |              |           |              |              |           |              |              |           |
| 100 Feet        | 3/4" IPS Iron pipe @ 11" water column regulator set pressure                   |   |  |  |  |           |           |              |              |           |              |              |           |              |              |           |
| 200,000         | 10 Feet  | 5/8" copper tubing @ 11" water column regulator set pressure                          | <br>MEGR-1232-HBF F. POL X 1/2"<br>MEGR-1232-HFF F. POL X 3/4"<br>MEGR-1232-BBF 1/4" X 1/2"  | <table border="1"> <thead> <tr> <th>POL X POL</th> <th>Length</th> <th>Part. No.</th> </tr> </thead> <tbody> <tr> <td>3/8" tube OD</td> <td>12"</td> <td>ME1680-12</td> </tr> <tr> <td>1/4" tube OD</td> <td>12"</td> <td>ME1664-12</td> </tr> <tr> <td>3/8" tube OD</td> <td>6"</td> <td>ME1680-06</td> </tr> </tbody> </table> | POL X POL  | Length    | Part. No. | 3/8" tube OD | 12"          | ME1680-12 | 1/4" tube OD | 12"          | ME1664-12 | 3/8" tube OD | 6"           | ME1680-06 |
|                 | POL X POL  | Length  |  | Part. No.  |  |           |           |              |              |           |              |              |           |              |              |           |
| 3/8" tube OD    | 12"  | ME1680-12   |  |  |  |           |           |              |              |           |              |              |           |              |              |           |
| 1/4" tube OD    | 12"  | ME1664-12   |  |  |  |           |           |              |              |           |              |              |           |              |              |           |
| 3/8" tube OD    | 6"   | ME1680-06   |  |  |  |           |           |              |              |           |              |              |           |              |              |           |
| 50 Feet         | 3/4" IPS Iron pipe @ 11" water column regulator set pressure                   |    |  |  |  |           |           |              |              |           |              |              |           |              |              |           |
| 300,000         | 3/4" IPS Iron pipe @ 11" water column regulator set pressure                   |   | <br>MEGR-1232-HFF F. POL X 3/4"<br>MEGR-1632-HCF F. POL X 1/2"<br>MEGR-1632-BCF 1/4" X 1/2" |  |  |           |           |              |              |           |              |              |           |              |              |           |
| 70 Feet         | 1" IPS Iron pipe @ 11" water column regulator set pressure                     |  |  |  |  |           |           |              |              |           |              |              |           |              |              |           |
| 400,000         | 20 Feet  |   | 3/4" IPS Iron pipe @ 11" water column regulator set pressure   | <br>MEGR-1232-HFF F. POL X 3/4"<br>MEGR-1632-JFF F. POL X 3/4"<br>MEGR-1632-CFF 1/4" X 3/4"  | <table border="1"> <thead> <tr> <th>POL X POL</th> <th>Length</th> <th>Part. No.</th> </tr> </thead> <tbody> <tr> <td>3/8" tube OD</td> <td>12"</td> <td>ME1680-12</td> </tr> <tr> <td>1/4" tube OD</td> <td>12"</td> <td>ME1664-12</td> </tr> <tr> <td>3/8" tube OD</td> <td>6"</td> <td>ME1680-06</td> </tr> </tbody> </table> | POL X POL | Length    | Part. No.    | 3/8" tube OD | 12"       | ME1680-12    | 1/4" tube OD | 12"       | ME1664-12    | 3/8" tube OD | 6"        |
|                 | POL X POL  | Length  | Part. No.  |  |  |           |           |              |              |           |              |              |           |              |              |           |
| 3/8" tube OD    | 12"  | ME1680-12   |  |  |  |           |           |              |              |           |              |              |           |              |              |           |
| 1/4" tube OD    | 12"  | ME1664-12   |  |  |  |           |           |              |              |           |              |              |           |              |              |           |
| 3/8" tube OD    | 6"   | ME1680-06   |  |  |  |           |           |              |              |           |              |              |           |              |              |           |
| 60 Feet         | 1" IPS Iron pipe @ 11" water column regulator set pressure                     |  |  |  |  |           |           |              |              |           |              |              |           |              |              |           |

**Instructions:**

- Determine the total gas demand for the system by adding up the BTU/hr input from the appliance nameplates and adding demand as appropriate for future appliances.
- For second stage or integral twin stage piping:
  - Measure length of piping required from outlet of regulator to the appliance furthest away. No other length is necessary to do the sizing.
  - Make a simple sketch of the piping, as shown.
  - Determine the capacity to be handled by each section of piping. For example, the capacity of the line between a and b must handle the total demand of appliances A, B, and C; the capacity of the line from c to d must handle only appliance B, etc.
  - Using one of the above Tables, select proper size of tubing or pipe for each section of piping, using values in BTU/hr for the length determined from step #2-A. If exact length is not on chart, use next longer length. Do not use any other length for this purpose! Simply select the size that shows at least as much capacity as needed for each piping section.
- For piping between first and second stage regulators
  - For a simple system with only one second stage regulator, merely measure length of piping required between outlet of first stage regulator and inlet of second stage regulator. Select piping or tubing required from one of the Tables.
  - For systems with multiple second stage regulators, measure length of piping required to reach the second stage regulator that is furthest away. Make a simple sketch, and size each leg of piping using Table 1, 2, or 3 using values shown in column corresponding to the length as measured above, same as when handling second stage piping.

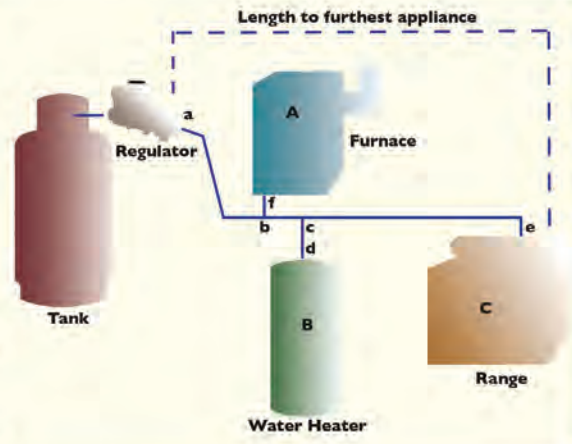

# DOMESTIC - INTEGRAL TWO-STAGE

## COMPACT MODELS

These Integral Two-Stage regulators combine the first and second stage regulator set-up into one convenient unit converting tank pressure to 11" WC. All MEC Integral Two-Stage domestic regulators are gray indicating low outlet pressure. Integral Two-Stage regulators are recommended for installations with short piping distances, but provide the same advantages of two-stage regulation with a single unit. All MEC integral two-stage regulator vent have tapped ports (7/16-24 - First Stage) (3/8" FNPT - Second Stage) and our exclusive E-Z Grip screens located over the outlet. The MEGR-1232 series offer optimal relief performance that well exceeds UL test requirements providing over pressure protection of no more than 2 PSI downstream pressure. MEC **Excela-Flo™** Integral Two-Stage domestic regulators feature a 25 year recommended replacement life, our exclusive **Tri-Tap™** (tank, 10 PSI, 11" WC) pressure port system and our exclusive 3-part tear away leak check adhesive sticker.

**MEGR-1232 Compact Series:** Offers a compact integral two-stage regulator design perfect for lower BTU applications and confined spaces. They feature an adjustment range from 9-13" WC (factory set @ 11" WC). Stainless steel integral components, fluorocarbon (FKM) seat discs, molded lip fabric reinforced diaphragms, and large precision machined aluminum orifices providing superior downstream regulation and maximum corrosion resistance against weather or contaminated gas.



- NEW patent pending anti-freeze heat transfer fins

### SPECIFICATIONS

**Type:** Integral Two-Stage  
**Max. Inlet Pressure:** 250 PSIG  
**Exterior Finish:** Gray Powder Coat  
**Interior Finish:** Gray Powder Coat  
**Orifice Size:** 0.170"  
**Seat Material:** Fluorocarbon (FKM)  
**Diaphragm:** Fabric Reinforced NBR / Molded Lip  
 O-Ring Bonnet Body Seal  
**Relief Type:** Internal Relief - Spring Loaded  
**Bonnet / Body Material:** Die Cast Aluminum  
**Listings:** cUL<sub>US</sub> / UL 144  
**Mounting Holes:** Standard 3-1/2" Center  
**Pressure Taps:** #54 Orifice, 1/8" FNPT, Plugged (3)  
**Relief Travel Stop:** Molded in Adjustment Cap - Gray



PATENT PENDING



| Part No.                       | Capacity in BTU/H LPG <sup>(1)</sup> | Inlet     | Outlet    | Outlet Adj. Range ("WC) | Outlet Set Point ("WC) |
|--------------------------------|--------------------------------------|-----------|-----------|-------------------------|------------------------|
| MEGR-1232-BBF                  | 450,000                              | 1/4" FNPT | 1/2" FNPT | 9.5-13                  | 11                     |
| MEGR-1232-BBFXA <sup>(2)</sup> | 450,000                              | 1/4" FNPT | 1/2" FNPT | 9.5-13                  | 11                     |
| MEGR-1232-HBF                  | 450,000                              | F. POL    | 1/2" FNPT | 9.5-13                  | 11                     |
| MEGR-1232-HBFXA <sup>(2)</sup> | 450,000                              | F. POL    | 1/2" FNPT | 9.5-13                  | 11                     |
| MEGR-1232-HFF                  | 625,000                              | F. POL    | 3/4" FNPT | 9.5-13                  | 11                     |
| MEGR-1232-HFFXA <sup>(2)</sup> | 625,000                              | F. POL    | 3/4" FNPT | 9.5-13                  | 11                     |
| MEGR-1232-HFFXB <sup>(3)</sup> | 625,000                              | F. POL    | 3/4" FNPT | 9.5-13                  | 11                     |

(1) Based on 30 PSIG inlet pressure and 20% droop

(3) Indicates regulator vents over pressure tap ports

(2) Indicates regulator vents opposite pressure tap ports

| Accessories |   |
|-------------|---|
| Part No.    | Description   |
| MEP1632     | MEC <b>Excela-Flo™</b> Integral Twin Stage - First Stage Vent Guard         |
| ME2130      | First Stage Pipe Away Elbow 1/4" M. Inverted Flare x 1/4" F. Inverted Flare |



Tested in the U.S.A

# FULL SIZE MODELS

These integral two-stage regulators combine the first and second stage regulator set-up into one convenient unit converting full tank pressure to 11" WC. All **MEC** integral two-stage domestic regulators are gray indicating low outlet pressure. Integral two-stage regulators are recommended for installations with short piping distances, but provide the same advantages of two-stage regulation with a single unit. All MEC integral two-stage regulator vent have tapped ports (7/16 -24-First Stage) (3/8" FNPT Second Stage Compact / 3/4" FNPT Second Stage Full Size) and our exclusive E-Z Grip screens located over the outlet. Both the MEGR-1232 and MEGR-1632 series offer optimal relief performance that exceeds UL test requirements providing over pressure protection of no more than 2 PSI downstream pressure. MEC **Excelsa-Flo™** integral two-stage domestic regulators feature a 25 year recommended replacement life, our exclusive **Tri-Tap™** (Tank, 10 PSI, 11" WC) pressure port system and tear away leak check adhesive sticker.

**MEGR-1632 Series:** Offers all of the same features as the compact MEGR-1232 series in a full size high capacity version. The full size MEGR-1632 diaphragm provides superior downstream regulation, has heavy duty wrench flats and a large 3/4" FNPT tapped drip lip vent to help prevent relief vent blockage.

## SPECIFICATIONS

- Type:** Integral Two-Stage
- Max. Inlet Pressure:** 250 PSIG
- Exterior Finish:** Gray Powder Coat
- Interior Finish:** Gray Powder Coat
- Orifice Size:** 0.219"
- Seat Material:** Fluorocarbon (FKM)
- Diaphragm:** Fabric Reinforced NBR / Molded Lip  
O-Ring Bonnet Body Seal
- Relief Type:** Internal Relief - Spring Loaded
- Bonnet / Body Material:** Die Cast Aluminum
- Listings:** cUL<sub>US</sub> / UL 144
- Mounting Holes:** Standard 3-1/2" Center
- Pressure Taps:** #54 Orifice, 1/8" FNPT, Plugged (3)
- Relief Travel Stop:** Molded in Adjustment Cap - Black

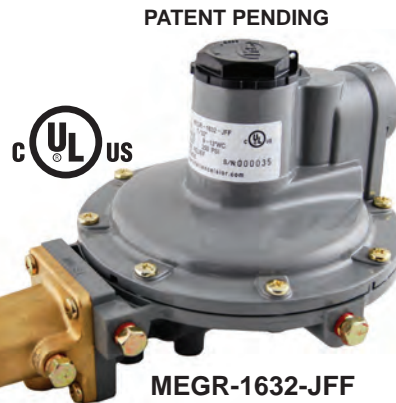
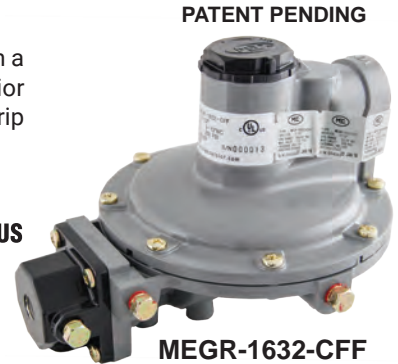

| Part No.                       | Capacity in BTU/H LPG <sup>(1)</sup> | Inlet     | Outlet    | Vent Port | Outlet Adj. Range ("WC) | Outlet Set Point ("WC) |
|--------------------------------|--------------------------------------|-----------|-----------|-----------|-------------------------|------------------------|
| MEGR-1632-BCF                  | 700,000                              | 1/4" FNPT | 1/2" FNPT | 3/4" FNPT | 9-13                    | 11                     |
| MEGR-1632-BCFXA <sup>(2)</sup> | 700,000                              | 1/4" FNPT | 1/2" FNPT | 3/4" FNPT | 9-13                    | 11                     |
| MEGR-1632-CFF                  | 950,000                              | 1/4" FNPT | 3/4" FNPT | 3/4" FNPT | 9-13                    | 11                     |
| MEGR-1632-CFFXA <sup>(2)</sup> | 950,000                              | 1/4" FNPT | 3/4" FNPT | 3/4" FNPT | 9-13                    | 11                     |
| MEGR-1632-HCF                  | 700,000                              | F. POL    | 1/2" FNPT | 3/4" FNPT | 9-13                    | 11                     |
| MEGR-1632-HCFXA <sup>(2)</sup> | 700,000                              | F. POL    | 1/2" FNPT | 3/4" FNPT | 9-13                    | 11                     |
| MEGR-1632-JFF                  | 900,000                              | F. POL    | 3/4" FNPT | 3/4" FNPT | 9-13                    | 11                     |
| MEGR-1632-JFFXA <sup>(2)</sup> | 900,000                              | F. POL    | 3/4" FNPT | 3/4" FNPT | 9-13                    | 11                     |
| MEGR-1632-JFFXB <sup>(3)</sup> | 900,000                              | F. POL    | 3/4" FNPT | 3/4" FNPT | 9-13                    | 11                     |

(1) Based on 30 PSIG inlet pressure and 20% droop

(2) Indicates regulator vents opposite pressure tap ports

(3) Indicates regulator vents over pressure tap ports

| Accessories |   |
|-------------|---|
| Part No.    | Description   |
| MEP1632     | Integral Twin Stage - First Stage Vent Guard                                |
| ME2130      | First Stage Pipe Away Elbow 1/4" M. Inverted Flare x 1/4" F. Inverted Flare |



# DOMESTIC - INTEGRAL TWO-STAGE

## FIRST STAGE VENT GUARD

The MEP1632, when installed properly into the first stage vent opening of any **MEC** MEGR-1232 or MEGR-1632 Series Integral Two Stage **Excela-Flo™** regulator, completely seals this port making it weather proof by preventing moisture from entering the vent portion of the regulator. Installing the MEP1632 meets all NFPA58 requirements for vent protection from elements on all MEC **Excela-Flo™** integral twin stage first stage regulator vent openings no matter whether it is exposed or under a cover. Orientation of the second stage regulator vent opening must stay facing vertically down or piped away per **MEC** regulator installation and operating instructions.

### MEP1632

Installed in MEGR-1632 Series  
Full Size Twin-Stage Regulator



MEP1632 Kit w/ instructions



\*Regulator  
not included

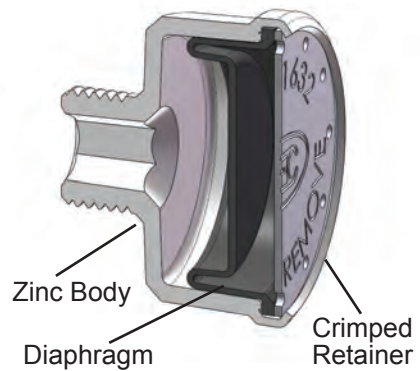

| Part No. | Description   |
|----------|---|
| MEP1632  | MEC <b>Excela-Flo™</b> Integral Twin Stage - First Stage Vent Guard |

### SPECIFICATIONS

- 7/16-24 UN threaded connection
- Anodized zinc die-cast body for maximum strength and durability
- Convenient wrenching flats for easy installation
- Supplied with sealing o-ring and installation instructions
- Sealed and crimped vulcanized diaphragm for leak & worry free service
- Does not restrict flow or impact regulator performance when installed properly



Tested in the  
U.S.A

# FLEX-VENT™ COMPACT REGULATOR KIT

The MEC **Flex-Vent™** provides a safe and easy solution to vent LP Gas regulators away from open sources of ignition or other potential fire hazards. Meets all requirements of the new flexible material allowance in the NFPA 58 – 2020 section 6.11.3.17.

## FEATURES

- Durable, UV stable flexible PVC hose material suitable for use with LP Gas vapor
- 3/4" NPT swivel inlet for easy installation
- Standard 90° vent assembly with screen
- Mounting clamps and coated masonry screws supplied
- Crimped ends for maximum durability
- Available in 3, 4, 6 & 10 ft. lengths\*



ME900-6



| Part No.   | Description   | Accessories                            |
|------------|---|--|
| ME960-36   | MEC Flex-Vent Kit - Fixed Ends - 3 ft.                      | 90° Regulator Vent Assembly<br>ME900-6 |
| ME960-48   | MEC Flex-Vent Kit - Fixed Ends - 4 ft.                      |  |
| ME960-72   | MEC Flex-Vent Kit - Fixed Ends - 6 ft.                      |  |
| ME960-120  | MEC Flex-Vent Kit - Universal Outlet (not crimped) - 10 ft. |  |
| ME960-120C | MEC Flex-Vent Kit - Universal Outlet (crimped) - 10 ft.     |  |

# FLEX-VENT™ COMPACT REGULATOR VENT ADAPTER

The MEP960 vent adapter allows universal installation of the ME960 series flex vent kits into the 3/8" FNPT vent port of the **MEC Excelsior™** compact regulators. The MEC **Flex-Vent™** provides a safe and easy solution to vent LP Gas regulators away from openings, sources of ignition or other potential fire hazards. Meets all requirements of the flexible material allowance in the NFPA 58 – 2020 section 6.11.3.17.

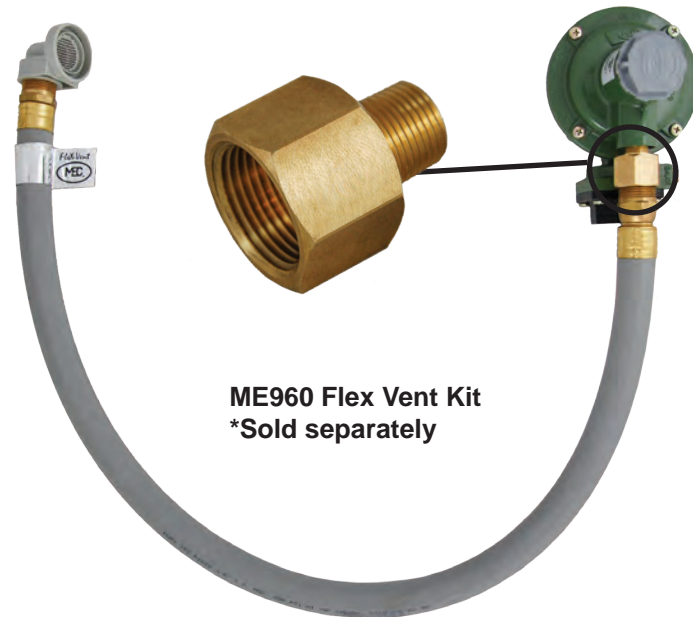

ME960 Flex Vent Kit  
\*Sold separately



## FEATURES

- Durable Brass Construction
- 3/8" MNPT x 3/4" FNPT adapter configuration

| Part # | Description  |
|--------|--|
| MEP960 | Compact Regulator Vent Adapter - 3/8" MNPT x 3/4" FNPT |





# DOMESTIC - INTEGRAL TWO STAGE

## TEE INLET

These Integral Two-Stage regulators combine the first and second stage regulator set-up into one convenient unit converting tank pressure to 11" WC with the convenience of a F. POL Tee inlet for multiple tank applications. All MEC Integral Two-Stage domestic regulators are gray indicating low outlet pressure. Integral Two-Stage regulators are recommended for installations with short piping distances, but provide the same advantages of two-stage regulation with a single unit. All MEC Integral Two-Stage regulator vent have tapped ports (7/16-24 - First Stage) (3/4" FNPT - Second Stage) and our exclusive E-Z Grip screens located over the outlet. Both the MEGR-1232T and MEGR-1632T series offer optimal relief performance that well exceeds UL test requirements providing over pressure protection of no more than 2 PSI downstream pressure. MEC **Excelsa-Flo™** integral two-stage domestic regulators feature a 25 year recommended replacement life, our exclusive Tri-Tap™ (tank, 10 PSI, 11" WC) pressure port system and tear away leak check adhesive sticker.

**NOTE:** All models available in "XA" configuration with both first & second stage vents located opposite pressure taps and tee inlets perpendicular to vents specifically for horizontal installation.



**MEGR-1232T Compact Series:** Offers a compact integral two-stage regulator design perfect for lower BTU applications and confined spaces. They feature an adjustment range from 9-13" WC (factory set @ 11" WC). Stainless steel integral components, fluorocarbon (FKM) seat discs, molded lip fabric reinforced diaphragms, and large precision machined aluminum orifices providing superior downstream regulation and maximum corrosion resistance against weather or contaminated gas.

### SPECIFICATIONS

- Type:** Integral Two-Stage
- Max. Inlet Pressure:** 250 PSIG
- Exterior Finish:** Gray Powder Coat
- Interior Finish:** Gray Powder Coat
- Orifice Size:** 0.17" (Compact) & 0.219" (Full)
- Seat Material:** Fluorocarbon (FKM)
- Diaphragm:** Fabric Reinforced NBR / Molded Lip O-Ring Bonnet/Body Seal
- Relief Type:** Internal Relief - Spring Loaded
- Bonnet / Body Material:** Die Cast Aluminum
- Listings:** cUL US / UL 144
- Mounting Holes:** Standard 3-1/2" Center
- Pressure Taps:** #54 Orifice 1/8" FNPT Plugged (3)
- Relief Travel Stop:** Molded in Adjustment Cap - Gray (Compact), Black (Full Size)



**MEGR-1632T Full Size Series:** Offers all of the same features as the compact MEGR-1232 series in a full size high capacity version. The full size MEGR-1632 diaphragm provides superior downstream regulation, has heavy duty wrench flats and a large 3/4" FNPT tapped drip lip vent to help prevent relief vent blockage.

| Part No.                        | Type      | Capacity in BTU/H LPG <sup>(1)</sup> | Inlet      | Outlet    | Outlet Adj. Range ("WC) | Outlet Set Point ("WC) |
|---------------------------------|-----------|--------------------------------------|------------|-----------|-------------------------|------------------------|
| MEGR-1232T-HBF                  | Compact   | 450,000                              | F. POL Tee | 1/2" FNPT | 9.5-13                  | 11                     |
| MEGR-1232T-HBFXA <sup>(2)</sup> | Compact   | 450,000                              | F. POL Tee | 1/2" FNPT | 9.5-13                  | 11                     |
| MEGR-1232T-HFF                  | Compact   | 625,000                              | F. POL Tee | 3/4" FNPT | 9.5-13                  | 11                     |
| MEGR-1232T-HFFXA <sup>(2)</sup> | Compact   | 625,000                              | F. POL Tee | 3/4" FNPT | 9.5-13                  | 11                     |
| MEGR-1632T-HCF                  | Full Size | 700,000                              | F. POL Tee | 1/2" FNPT | 9-13                    | 11                     |
| MEGR-1632T-HCFXA <sup>(2)</sup> | Full Size | 700,000                              | F. POL Tee | 1/2" FNPT | 9-13                    | 11                     |
| MEGR-1632T-JFF                  | Full Size | 900,000                              | F. POL Tee | 3/4" FNPT | 9-13                    | 11                     |
| MEGR-1632T-JFFXA <sup>(2)</sup> | Full Size | 900,000                              | F. POL Tee | 3/4" FNPT | 9-13                    | 11                     |

(1) Based on 30 PSIG inlet pressure and 20% droop  
 (2) Indicates regulator vents opposite pressure tap ports

| Accessories |   |
|-------------|---|
| Part No.    | Description   |
| MEP1632     | MEC <b>Excelsa-Flo™</b> Integral Twin Stage - First Stage Vent Guard        |
| ME2130      | First Stage Pipe Away Elbow 1/4" M. Inverted Flare x 1/4" F. Inverted Flare |



Tested in the U.S.A

## 2 PSI OUTLET PRESSURE

**MEC Excelsa-Flo™** Integral Two-Stage regulators combine the first and second stage regulator set-up into one convenient unit converting tank pressure to 2 PSI. All MEC integral two-stage 2 PSI regulators are white indicating 2 PSI outlet pressure. Integral two-stage 2 PSI regulators are recommended for installations with short piping distances, but provide the same advantages of two-stage regulation with a single unit. 2 PSI service regulators are used in conjunction with an LPG line regulator either at the indoor appliance or a remote manifold distribution header inlet. All MEC integral two-stage regulator vent have tapped ports (7/16 -24 - First Stage) (3/8" FNPT or 3/4" FNPT - Second Stage) and our exclusive E-Z Grip screens located over the outlet. Both the MEGR-1232E and MEGR-1632E series offer optimal relief performance that well exceeds UL test requirements providing over pressure protection of no more than 4 PSI downstream pressure.

MEC **Excelsa-Flo™** Integral Two-Stage domestic regulators feature a 25 year recommended replacement life, our exclusive **Tri-Tap™** (tank, 10 PSI, 2 PSI) pressure port system and tear away leak check adhesive sticker.

### SPECIFICATIONS

- Type:** Integral Two-Stage 2 PSI
- Max. Inlet Pressure:** 250 PSIG
- Exterior Finish:** White Powder Coat
- Interior Finish:** White Powder Coat
- Orifice Size:** 0.17" (Compact) & 0.219" (Full)
- Seat Material:** Fluorocarbon (FKM)
- Diaphragm:** Fabric Reinforced NBR / Molded Lip O-Ring Bonnet/Body Seal
- Relief Type:** Internal Relief - Spring Loaded
- Bonnet / Body Material:** Die Cast Aluminum
- Listings:** cUL<sub>US</sub> / UL 144
- Mounting Holes:** Standard 3-1/2" Center
- Pressure Taps:** #54 Orifice 1/8" FNPT Plugged (3)
- Relief Travel Stop:** Molded in Adjustment Cap - Gray (Compact), Black (Full Size)

PATENT PENDING



**MEGR-1232E Compact Series:** Offers a compact integral two-stage 2 PSI regulator design perfect for lower BTU applications and confined spaces. They feature an adjustment range from 1-2.2 PSI (factory set @ 2 PSI). Stainless steel integral components, fluorocarbon (FKM) seat discs, molded lip fabric reinforced diaphragms, and large precision machined aluminum orifices providing superior downstream regulation and maximum corrosion resistance against weather or contaminated gas.



**MEGR-1632E Full Size Series:** Offers all of the same features as the compact MEGR-1232E series in a full size high capacity version. The full size MEGR-1632E diaphragm provides superior downstream regulation, has heavy duty wrench flats and a large 3/4" FNPT tapped drip lip vent to help prevent relief vent blockage.

| Part No.                        | Type      | Capacity in BTU/H LPG <sup>(1)</sup> | Inlet     | Outlet    | Outlet Adj. Range (PSI) | Outlet Set Point (PSI) |
|---------------------------------|-----------|--------------------------------------|-----------|-----------|-------------------------|------------------------|
| MEGR-1232E-BBH                  | Compact   | 500,000                              | 1/4" FNPT | 1/2" FNPT | 1-2.2                   | 2                      |
| MEGR-1232E-BBHXA <sup>(2)</sup> | Compact   | 500,000                              | 1/4" FNPT | 1/2" FNPT | 1-2.2                   | 2                      |
| MEGR-1232E-HBH                  | Compact   | 500,000                              | F. POL    | 1/2" FNPT | 1-2.2                   | 2                      |
| MEGR-1232E-HBHXA <sup>(2)</sup> | Compact   | 500,000                              | F. POL    | 1/2" FNPT | 1-2.2                   | 2                      |
| MEGR-1632E-BCH                  | Full Size | 850,000                              | 1/4" FNPT | 1/2" FNPT | 1-2.2                   | 2                      |
| MEGR-1632E-BCHXA <sup>(2)</sup> | Full Size | 850,000                              | 1/4" FNPT | 1/2" FNPT | 1-2.2                   | 2                      |
| MEGR-1632E-CFH                  | Full Size | 850,000                              | 1/4" FNPT | 3/4" FNPT | 1-2.2                   | 2                      |
| MEGR-1632E-CFHXA <sup>(2)</sup> | Full Size | 850,000                              | 1/4" FNPT | 3/4" FNPT | 1-2.2                   | 2                      |
| MEGR-1632E-HCH                  | Full Size | 900,000                              | F. POL    | 1/2" FNPT | 1-2.2                   | 2                      |
| MEGR-1632E-HCHXA <sup>(2)</sup> | Full Size | 900,000                              | F. POL    | 1/2" FNPT | 1-2.2                   | 2                      |
| MEGR-1632E-JFH                  | Full Size | 850,000                              | F. POL    | 3/4" FNPT | 1-2.2                   | 2                      |
| MEGR-1632E-JFHXA <sup>(2)</sup> | Full Size | 850,000                              | F. POL    | 3/4" FNPT | 1-2.2                   | 2                      |



(1) Based on 30 PSIG inlet pressure and 20% droop  
 (2) Indicates regulator vents opposite pressure tap ports

| Accessories |   |
|-------------|---|
| Part No.    | Description   |
| MEP1632     | MEC <b>Excelsa-Flo™</b> Integral Twin Stage - First Stage Vent Guard        |
| ME2130      | First Stage Pipe Away Elbow 1/4" M. Inverted Flare x 1/4" F. Inverted Flare |



# DOMESTIC - FIRST STAGE

## REGULATOR DEMONSTRATION KIT

Intended for use as a educational tool for visual representation of direct operated regulator functions and features. This kit includes a clear polymer model of the **Excelsa-Flo™** integral compact twin stage regulator that is fully functional allowing basic regulator adjustment, lock up, flow, pressure test and relief valve operation. The clear polymer body/bonnet allows observers to visually witness the operating components of the regulator under these conditions. This is the ideal tool to provide hands on training anywhere that compressed air is available.

**WARNING:** This regulator is intended for demonstrational purposes only. Only operate using compressed air. Do not use this regulator with LPG or any other flammable or dangerous gases.



### FEATURES

- Clear polymer body/bonnet for clear visual indication of inner components
- 100% operational for pressures up to 120 PSIG
- Supplied with convenient standard air quick disconnect couplers
- Includes all necessary components and accessories to demonstrate regulator operations
- Heavy duty foam insert and lockable carrying case for safe transport and storage

| Part No.       | Description   |
|----------------|---|
| MEGR-1232-DEMO | <b>Excelsa-Flo™</b> Twin Stage Demonstration Kit w/ Hard Case |

# INTEGRAL TWO-STAGE 2 PSI OUTLET PRESSURE

The MEGR-300 Compact Integral Two Stage 2 PSI Regulator is approved for use in nearly all portable applications and light duty domestic installations. Ideally suited for installations to reduce tank pressure to a nominal 2 PSI outlet pressure. 2 PSI systems typically incorporate a line service regulator within the home that further reduces the 2 PSI system pressure to approximately 11" WC prior to the appliance. These regulators feature all zinc body construction, red powder coated bonnets (identify 2 PSI model), high and low 1/8" NPT pressure tap ports, an integral second stage drip lip vent, and optional standard or 90 degree vent locations.

The MEGR-300 series compact high capacity integral two stage regulator meet UL, and NFPA requirements.

## SPECIFICATIONS

- Type:** Two Stage
- Max. Inlet Pressure:** 250 PSI
- Inlet Connection:** 1/4" FNPT
- Outlet Connection:** 3/8" FNPT
- Exterior Finish:** Red Powder Coat / Raw Zinc
- Diaphragm:** Fabric Reinforced Molded with O-Ring Bonnet / Body Seal
- Diaphragm Type:** Internal Relief - Spring Loaded
- Bonnet / Body Material:** Die Cast Zinc
- Listings:**  LISTED / UL 144
- Mounting Holes:** 3-1/2" On Center
- Pressure Taps:** 1/8" FNPT Plugged



MEGR-300

| Part No.    | Description   | BTU/H LPG @ 30 PSI Inlet* | Accessories                |
|-------------|---|---------------------------|----------------------------|
| MEGR-300    | Compact 2 Stage 2 PSI Regulator 1/4" FNPT Inlet x 3/8" FNPT Outlet            | 225,000                   | MEGR-900 (Z-Bracket)       |
| MEGR-300-90 | Compact 2 Stage 2 PSI Regulator 1/4" FNPT Inlet x 3/8" FNPT Outlet - 90° Vent |                           | MEGR-861 (1st Stage Cover) |
|             |   |                           | MEGR-862 (2nd Stage Cover) |

\* Setpoint: 100 PSIG Inlet @ 2 PSI Outlet Flowing @ 30 SCFH Air



**MEGR-900**  
Z-Mounting Bracket



**MEGR-861**  
First Stage Cover



**MEGR-862**  
Second Stage Cover

# DOMESTIC - AUTOMATIC CHANGEOVER

EXCELA-FLO™ REGULATORS



**MEGR-175CS61222-BAF**



**MEGR-175CS61622-BCF**



**MEGR-175CS61622E-BCH**

These Two Stage Automatic Changeover regulators combine the first and second stage regulator into one unit converting full tank pressure to 11" WC. MEC **Excelsa-Flo™** Automatic Changeover regulators prevent gas outages by switching supply cylinders over to the reserve cylinder automatically when the primary cylinder is near empty. When the primary cylinder is depleted causing the changeover to occur a red indicator will appear signifying the reserve cylinder is now in use and the primary cylinder can be refilled without loss of service.

## SPECIFICATIONS

- Type:** Automatic Changeover Two-Stage
- Max. Inlet Pressure:** 250 PSIG
- Exterior Finish:** Gold / Green Powder Coat
- Orifice Size:** 0.140" (Compact) & 0.219" (Full)
- Seat Material:** (NBR) 1st Stage, Fluorocarbon (FKM) 2nd Stage
- Diaphragm:** Fabric Reinforced (NBR) /  
Molded Lip O-Ring Bonnet/Body Seal
- Relief Type:** Internal Relief - Spring Loaded
- Bonnet / Body Material:** Die Cast Zinc/Plastic 1st Stage,  
Die Cast Aluminum 2nd Stage
- Listings:**  / UL 144 2<sup>nd</sup> Stage
- Mounting Holes:** Standard 3-1/2" Center
- Pressure Taps:** #54 Orifice, 1/8" FNPT, Plugged (1)
- Relief Travel Stop:** Molded in Adjustment Cap -  
Gray (Compact), Black (Full Size)

**MEGR-175CS61622-BCF Series:** Offers all of the same features as the compact MEGR-175S61222 series but with a full size high capacity second stage regulator option. The full size second stage diaphragm provides superior downstream regulation and features heavy duty wrench flats and a large 3/4" FNPT tapped drip lip vent to help prevent relief vent blockage. This regulator is perfect for manifolding larger tanks together such as 420 LB cylinders.

**MEGR-175CS61222-BAF Series:** Offers a compact two stage regulator option for lower BTU applications such as mobile or seasonal homes. They feature a second stage adjustment from 8-14" WC (factory set @ 11" WC), stainless steel internal components, fluorocarbon (FKM) seat discs, molded lip fabric reinforced diaphragms, and large precision machined aluminum orifices providing superior downstream regulation and maximum resistance against weather or contaminated gas. The compact second stage features a 3/8" FNPT drip lip vent.

| Part No.                    | Type      | Primary Cylinder Capacity in BTU/H LPG <sup>(1)</sup> | Auxiliary Cylinder Capacity in BTU/H LPG <sup>(1)</sup> | Inlet       | Outlet    | Outlet Adj. Range ("WC) | Outlet Set Point ("WC) |
|-----------------------------|-----------|---|---|-------------|-----------|-------------------------|------------------------|
| <b>MEGR-175CS61222-BAF</b>  | Compact   | 400,000   | 340,000   | 1/4" IF (2) | 1/2" FNPT | 9.5-13                  | 11                     |
| <b>MEGR-175CS61622-BCF</b>  | Full Size | 650,000   | 570,000   | 1/4" IF (2) | 1/2" FNPT | 9-13                    | 11                     |
| <b>MEGR-175CS61622E-BCH</b> | Full Size | 625,000   | 525,000   | 1/4" IF (2) | 1/2" FNPT | 1.0-2.2 PSI             | 2 PSI                  |

(1) Based on 30 PSIG inlet pressure and 20% droop



# AUTOMATIC CHANGEOVER



The **MEGR-253 Series** Automatic Changeover regulators automatically redirect LP gas vapor flow from an empty service cylinder to a reserve cylinder, without interruption of service. It features an easy to read green indicator which changes to red when the service cylinder needs to be refilled.

As a two-stage high-pressure regulator, the **MEGR-253H** reduces container pressure to approximately 10 to 15 PSIG and then the second stage completes the process by reducing inlet pressure down to 11 inches of water column outlet pressure.

The **MEGR-253L** is specifically intended for application with low BTU demands but still require two stage regulation. The Model MEGR-253L is ideally suited for RV, manufactured homes, cabins or other applications with a single appliance or low BTU multiple appliance applications while still permitting maximum range of output pressure adjustment.

The MEGR-253, MEGR-253H and MEGR-253L Series regulators meet UL, RVIA and NFPA requirements.

## SPECIFICATIONS

- Type:** Two Stage
- Max Inlet Pressure:** 250 PSI
- Inlet Connection:** 1/4" Female Inverted Flare (2)
- Outlet Connection:** 3/8" FNPT (1)
- Exterior Finish:** Unfinished Zinc (MEGR-253), Powder Coat (MEGR-253H & 253L)
- Diaphragm:** Fabric Reinforced Molded with O-Ring Bonnet / Body Seal
- Relief Type:** Internal Relief - Spring Loaded
- Bonnet / Body Material:** Die Cast Zinc
- Listings:** LISTED / UL 144
- Mounting Holes:** 3-1/2" On Center
- Pressure Taps:** 1/8" FNPT, Plugged (1)

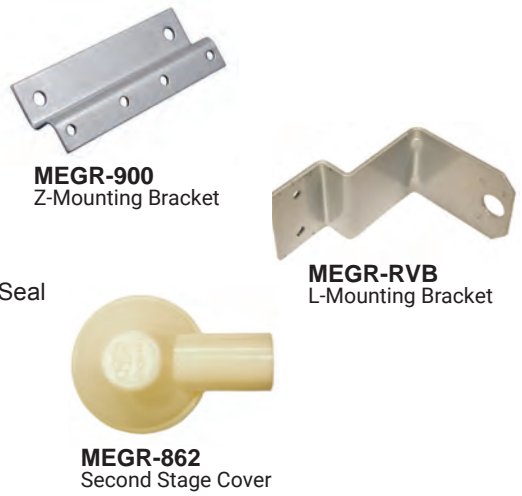

| Part No.         | Description  | Primary Cylinder BTU/Hr.* | Reserve Cylinder BTU/Hr.* | Covers   | Mounting Bracket     |
|------------------|--|---------------------------|---------------------------|----------|----------------------|
| <b>MEGR-253</b>  | 2 Stage Auto Changeover Regulator 1/4" Inv. Flare x 3/8" FPT               | 225,000                   | 150,000                   | MEGR-862 | MEGR-900 or MEGR-RVB |
| <b>MEGR-253H</b> | High Capacity 2 Stage Auto Changeover Regulator 1/4" Inv. Flare x 3/8" FPT | 350,000                   | 200,000                   |          |                      |
| <b>MEGR-253L</b> | Low Capacity 2 Stage Auto Changeover Regulator 1/4" Inv. Flare x 3/8" FPT  | 150,000                   | 100,000                   |          |                      |

\* BTU/H Capacity @ 20% Droop  
 Note: MEGR-253 and MEGR-253H set point: 100 PSIG Inlet @ 11" WC outlet flowing @ 30 SCFH Air  
 MEGR-253L set point: 100 PSIG Inlet @ 11" WC outlet flowing @ 10 SCFH Air



# COMPACT INTEGRAL TWO STAGE

**MEGR-291**  
Compact Regulator  
with Drip Lip Vent

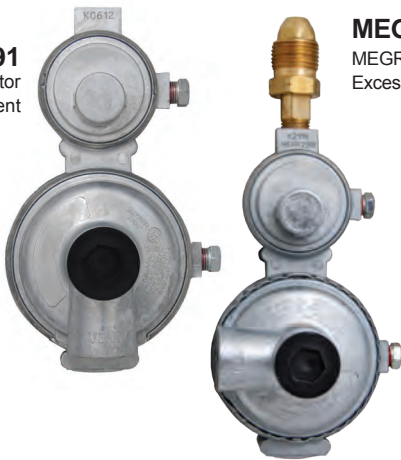

**MEGR-295**  
MEGR-298 with Hard-Nose  
Excess Flow POL

**MEGR-291H**  
High Capacity Regulator  
with Drip Lip Vent

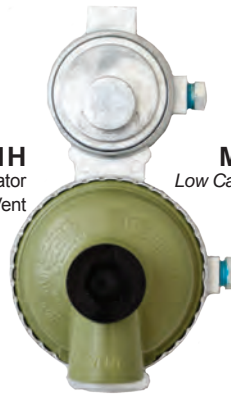

**MEGR-298L**  
Low Capacity Regulator  
with Side Vent

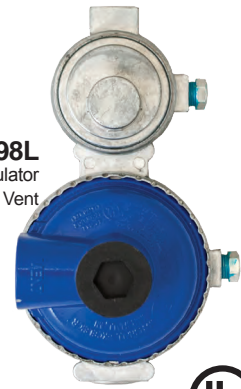

## SPECIFICATIONS

- Type:** Two Stage
- Max. Inlet Pressure:** 250 PSI
- Inlet Connection:** 1/4" FNPT
- Outlet Connection:** 3/8" FNPT
- Exterior Finish:** Unfinished Zinc / Powder Coated
- Diaphragm:** Fabric Reinforced Molded with O-Ring Bonnet / Body Seal
- Diaphragm Type:** Internal Relief - Spring Loaded
- Bonnet/ Body Material:** Die Cast Zinc
- Listings:** LISTED / UL 144
- Mounting Holes:** 3-1/2" On Center
- Pressure Taps:** 1/8" FNPT Plugged

The **MEC MEGR-291** two-stage regulators are approved for use in nearly all portable applications and outdoor cooking appliances utilizing low pressure. They feature all zinc body construction, high and low 1/8" NPT pressure tap ports, an integral second stage drip lip vent and optional standard or 90 degree vent locations.

The **MEGR-291H** is ideally suited for high demand RV, outdoor appliances, cabins, seasonal homes, gas fire places, water heaters, ranges or other moderate to low demand domestic home installations. (Green bonnet identifies high capacity model).

The **MEGR-291L** is specifically intended for application with low BTU demands but still require two stage regulation. The Model MEGR-291L is ideally suited for RV, manufactured homes, cabins or other applications with one appliance or low BTU multiple appliance applications while still permitting maximum range of output pressure adjustment.

The MEGR-291 Series regulators meet UL, RVIA and NFPA requirements.

| Part No.        | Description  | BTU/H<br>LPG @ 30<br>PSI Inlet* | Accessories   |
|-----------------|--|---------------------------------|---|
| MEGR-291        | Compact 2 Stage Regulator 1/4" FNPT Inlet x 3/8" FNPT Outlet                                   | 175,000                         | MEGR-RVB<br>(L- Bracket)<br><br>MEGR-900<br>(Z-Bracket)<br><br>MEGR-861<br>(1st Stage<br>Cover)<br><br>MEGR-862<br>(2nd Stage<br>Cover) |
| MEGR-291H       | Compact 2 Stage High Capacity Regulator 1/4" FNPT Inlet x 3/8" FNPT Outlet                     | 225,000                         |   |
| MEGR-291L       | Compact 2 Stage Low Capacity Regulator 1/4" FNPT Inlet x 3/8" FNPT Outlet                      | 120,000                         |   |
| MEGR-298        | Compact 2 Stage Regulator 1/4" FNPT Inlet x 3/8" FNPT Outlet - 90° Vent                        | 175,000                         |   |
| MEGR-298H       | Compact 2 Stage High Capacity Regulator 1/4" FNPT Inlet x 3/8" FNPT Outlet - 90° Vent          | 225,000                         |   |
| MEGR-298L       | Compact 2 Stage Low Capacity Regulator 1/4" FNPT Inlet x 3/8" FNPT Outlet - 90° Vent           | 120,000                         |   |
| MEGR-295        | Compact 2 Stage Regulator HN Excess Flow POL Inlet x 3/8" FNPT Outlet - 90° Vent               | 175,000                         |   |
| MEGR-295H       | Compact 2 Stage High Capacity Regulator HN Excess Flow POL Inlet x 3/8" FNPT Outlet - 90° Vent | 225,000                         |   |
| MEGR-295L       | Compact 2 Stage Low Capacity Regulator HN Excess Flow POL Inlet x 3/8" FNPT Outlet - 90° Vent  | 120,000                         |   |
| MEGR-291-20681  | Compact 2 Stage Regulator Green Type I QCC Inlet x 3/8" FNPT Outlet                            | 175,000                         |   |
| MEGR-291H-20681 | Compact 2 Stage High Capacity Regulator Green Type I QCC Inlet x 3/8" FNPT Outlet              | 225,000                         |   |
| MEGR-298-20681  | Compact 2 Stage Regulator Green Type I QCC Inlet x 3/8" FNPT Outlet - 90° Vent                 | 175,000                         |   |
| MEGR-298H-20681 | Compact 2 Stage High Capacity Regulator Green Type I QCC Inlet x 3/8" FNPT Outlet - 90° Vent   | 225,000                         |   |

MEGR-291 and MEGR-291H setpoint: 100 PSIG Inlet @ 11" WC Outlet Flowing @ 30 SCFH Air  
\* BTU/H Capacity @ 20% Droop



**MEGR-900**  
Z-Mounting Bracket



**MEGR-861**  
First Stage Cover



**MEGR-862**  
Second Stage Cover

# LOW PRESSURE - SINGLE STAGE

The MEGR-230 single-stage regulators are approved for use in small portable applications and outdoor cooking appliances utilizing low pressure.

NOTE: Single-stage regulators are not approved for RV use per NFPA 1192.

## SPECIFICATIONS

- Type:** Single Stage
- Orifice Diameter:** 0.059" Diameter
- BTU Capacity:** 140,000 BTU (based on 25 PSI inlet @ 20% droop)
- Max. Inlet Pressure:** 250 PSI
- Inlet Connection:** 1/4" FNPT
- Outlet Connection:** 3/8" FNPT
- Exterior Finish:** Green Wet Coat
- Diaphragm Type:** Molded with O-Ring Bonnet / Body Seal
- Bonnet/Body Material:** Die Cast Aluminum
- Listings:**  LISTED / UL 144
- Mounting Holes:** 1" On Center

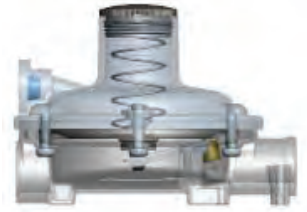

| Part No.      | Description   | Outlet Pressure Setting  | Vent Orientation |
|---------------|---|--------------------------|------------------|
| MEGR-218      | Single Stage Regulator - SN FF POL w/ Plastic Handwheel x 3/8" FNPT - 90° Vent  | 11-inches w.c. (27 mbar) | 90°              |
| MEGR-230      | Single Stage Regulator - 1/4" FNPT Inlet X 3/8" FNPT Outlet                     |                          | Over Outlet      |
| MEGR-230-9    | Single Stage Regulator - SN .9 GPM Excess Flow POL Inlet x 3/8" FNPT Outlet     |                          | Over Outlet      |
| MEGR-230-90   | Single Stage Regulator - 1/4" FNPT Inlet X 3/8" FNPT Outlet - 90° Vent          |                          | 90°              |
| MEGR-230-1618 | Single Stage Regulator - Black F. QCC Inlet x 3/8" FNPT Outlet - 90° Vent       |                          | 90°              |
| MEGR-230-1326 | Single Stage Regulator - Black F. QCC Inlet (100,000 BTU/ H) x 3/8" FNPT Outlet |                          | Over Outlet      |
| MEGR-231      | Single Stage Regulator - Hardnose FF POL Inlet x 3/8" FNPT Outlet - 90° Vent    |                          | 90°              |





# SINGLE STAGE PRESSURE REDUCING

The **MEGR-1912 Series** UL Listed regulators are direct-operated, spring-loaded models designed for use in a variety of service and industrial applications. These regulators have limited-capacity internal relief across the diaphragm to help minimize over pressurization.

The **MEGR-1912 Series** with capacity ratings of less than 320,000 BTU/hr (129 scfh), are often used on small portable outdoor appliances.

Underwriters Laboratories requires horizontally mounted regulators to be installed with vent opening protection to prevent blockage by freezing rain.

## SPECIFICATIONS

- Type:** Single Stage
- Max. Inlet Pressure:** 250 PSI
- Vent Screen:** Monel
- Gasket:** CGR 2750
- Relief Valve:** Brass and Zinc
- Control and Relief Valve Spring:** Plated Steel
- Diaphragm Assembly:** Nitrile (NBR) with Zinc disk
- Spring Case:** Die Cast - Zinc
- Spring Seat:** Plated Steel
- Diaphragm Plate:** Plated Steel
- Body Material / Lower Casting:** Die Cast - Zinc
- Temperature Range:** -20° to 170° F
- Approximate Weight:** 1.3 lbs.
- Listings:** Select models are UL Listed / UL 144



**MEGR-1912  
Series**

| Part No.               | Inlet x Outlet Connection Style | Orifice Sizes, Inches (mm) | Outlet Pressure Setting  | Outlet Pressure Ranges, Inches W.C. (mbar) | Vent Orientation | BTU/H LPG @ 100 PSI Inlet |
|------------------------|---------------------------------|----------------------------|--------------------------|--|------------------|---------------------------|
| <b>MEGR-1912/101*</b>  | 1/4" x 3/8" FNPT                | 0.073 (1,8)                | 11-inches w.c. (27 mbar) | 9.25 to 13 (23 to 32)                      | Over Outlet      | 242,953                   |
| <b>MEGR-1912/104*</b>  | 1/4" x 1/4" FNPT                | 0.073 (1,8)                | 11-inches w.c. (27 mbar) | 9.25 to 13 (23 to 32)                      | Over Outlet      | 242,953                   |
| <b>MEGR-1912/109</b>   | 1/4" x 3/8" FNPT                | 0.073 (1,8)                | 7-inches w.c. (17 mbar)  | 5 to 10 (12 to 25)                         | Over Outlet      | 242,953                   |
| <b>MEGR-1912/197</b>   | 1/4" x 3/8" FNPT                | 0.094 (2,4)                | 20-inches w.c. (50 mbar) | 12 to 24 (30 to 60)                        | Over Outlet      | 313,488                   |
| <b>MEGR-1912H/108*</b> | 1/4" x 3/8" FNPT                | 0.094 (2,4)                | 1.5 PSI (103 mbar)       | 0.8 to 2.7 psi (34 to 186 mbar)            | Over Outlet      | 297,814                   |
| <b>MEGR-1912H/520*</b> | 1/4" x 1/4" FNPT                | 0.094 (2,4)                | 3.5 PSI (241 mbar)       | 2.7 to 5 psi (186 to 345 mbar)             | Over Outlet      | ----                      |
| <b>MEGR-1912N/113</b>  | 1/4" x 3/8" FNPT                | 0.073 (1,8)                | 5-inches w.c. (27 mbar)  | 3 to 7 (7 to 17)                           | Over Outlet      | ----                      |

\* UL Listed / UL 144

NOTE: Other configurations and materials available upon request



# HIGH PRESSURE

The **MEGR-130 series** fixed high pressure single stage regulators are designed to provide an economical solution for pounds to pounds service applications. The MEGR-130 can be used to regulate air as well as LP gas. Regulators must be installed in compliance with federal, state or local codes or laws in accordance with NFPA 58.



**MEGR-130-30**  
Pre-Set at 30 PSIG



| Non-Adjustable Configurations |   |
|-------------------------------|---|
| Part No.                      | Description   |
| <b>MEGR-130-05</b>            | Compact High Pressure Fixed Reg 5 PSI - 1/4" FNPT Inlet/Outlet  |
| <b>MEGR-130-10</b>            | Compact High Pressure Fixed Reg 10 PSI - 1/4" FNPT Inlet/Outlet |
| <b>MEGR-130-20</b>            | Compact High Pressure Fixed Reg 20 PSI - 1/4" FNPT Inlet/Outlet |
| <b>MEGR-130-30</b>            | Compact High Pressure Fixed Reg 30 PSI - 1/4" FNPT Inlet/Outlet |
| <b>MEGR-130-50</b>            | Compact High Pressure Fixed Reg 50 PSI - 1/4" FNPT Inlet/Outlet |
| <b>MEGR-130-80</b>            | Compact High Pressure Fixed Reg 80 PSI - 1/4" FNPT Inlet/Outlet |

### SPECIFICATIONS

- Type:** Adjustable or Fixed / PSI
- Max. Inlet Pressure:** 250 PSIG (17,2 bar)
- Inlet Connection:** 1/4" FNPT
- Outlet Connection:** 1/4" FNPT
- Orifice Diameter:** 0.0625"
- Exterior Finish:** Red Anodized
- Diaphragm:** Fabric Reinforced Buna N
- Bonnet/Body Material:** Die Cast Zinc
- BTU / H Capacity:** 1,200,000 BTU/H @ 40 PSI
- Listings:** UL LISTED / UL 144



**MEGR-350 Series** -Single stage, adjustable high pressure regulator. The body and bonnet of both the fixed and adjustable regulators are precisely machined and feature a crimped design and fabric reinforced rubber diaphragm creating a positive seal for leak-free performance.

**MEGR-360** with the Type I (QCC) is designed specifically for appliances such as turkey fryers, fish fryers, camp stoves and torch applications that require pounds to pounds pressure instead of inches water column. These regulators will meet or exceed most requirements on a specific outlet setting (0-10 PSI) depending on the application.



**MEGR-350**  
Adjustable 0-10 PSIG



| Adjustable Configurations |   |
|---------------------------|---|
| Part No.                  | Description   |
| <b>MEGR-350</b>           | Compact High Press. Adjustable Reg 0-10 PSI - 1/4" FNPT Inlet/Outlet      |
| <b>MEGR-350-20</b>        | Compact High Press. Adjustable Reg 0-20 PSI - 1/4" FNPT Inlet/Outlet      |
| <b>MEGR-350-30</b>        | Compact High Press. Adjustable Reg 0-30 PSI - 1/4" FNPT Inlet/Outlet      |
| <b>MEGR-351</b>           | Compact High Pressure Adjustable Reg 0-10 PSI - Full Flow POL x 1/4" FNPT |
| <b>MEGR-360</b>           | Compact High Pressure Adjustable Reg 0-10 PSI - Black F. QCC x 1/4" FNPT  |

NOTE: Not designed to provide 100% shutoff of flow



# HIGH PRESSURE

The **MEGR-6120 Series** are UL listed high-pressure regulators that meet a variety of applications for liquid or vapor service. The compact body design makes these regulators particularly useful in installations with space limitations. The basic MEGR-6120 Series regulators come equipped with a handwheel adjustment. The non-adjustable ME6121 Series provides a tamper-resistant spring case and one of seven fixed set points: 5, 10, 20, 30, 40, 50, or 60 PSI.

The MEGR-6120 & MEGR-6121 Series are UL listed as high pressure, non-relief regulators. Both MEGR-6120 & MEGR-6121 Series regulators contain brass materials that are not compatible with anhydrous ammonia service.

## SPECIFICATIONS

- Type:** Adjustable or Fixed / PSI
- Max. Inlet Pressure:** 250 PSI (17, 2 bar)
- Inlet Connection:** 1/4" FNPT
- Outlet Connection:** 1/4" FNPT
- Gauge Port:** 1/4" FNPT
- Exterior Finish:** Red Wet Coat
- Diaphragm:** Fabric Reinforced Buna N
- Body / Bonnet Material:** Die Cast Aluminum
- Liquid Capacity:** 3-5 GPH
- Listings:** UL LISTED / UL 144

MEGR-6120 Series 



| Adjustable Configurations |   |
|---------------------------|---|
| Part No.                  | Description   |
| <b>MEGR-6120-30</b>       | High Pressure Adjustable Reg 1-30 PSI - 1/4" FNPT Inlet/Outlet  |
| <b>MEGR-6120-60</b>       | High Pressure Adjustable Reg 1-60 PSI - 1/4" FNPT Inlet/Outlet  |
| <b>MEGR-6120-100</b>      | High Pressure Adjustable Reg 1-100 PSI - 1/4" FNPT Inlet/Outlet |

| CAPACITIES: BTU/H LPG (VAPOR) |                |           |
|-------------------------------|----------------|-----------|
| Outlet Set Point              | Inlet Pressure | BTU / HR  |
| 15 PSI                        | 50 PSI         | 850,000   |
| 15 PSI                        | 100 PSI        | 1,700,000 |
| 15 PSI                        | 150 PSI        | 2,500,000 |
| 20 PSI                        | 50 PSI         | 900,000   |
| 20 PSI                        | 100 PSI        | 1,800,000 |
| 40 PSI                        | 100 PSI        | 1,500,000 |
| 40 PSI                        | 150 PSI        | 2,000,000 |
| 50 PSI                        | 100 PSI        | 1,300,000 |
| 50 PSI                        | 150 PSI        | 1,800,000 |
| 50 PSI                        | 200 PSI        | 2,300,000 |

Approximate BTU/H vapor capacities taking 10-20% droop into consideration

Note: Side Outlet Connection Style (Plugged): 1/4" MNPT, pressure gauge (MEJ500 Series) can be installed

MEGR-6121 Series 



| Non-Adjustable Configurations |  |
|-------------------------------|--|
| Part No.                      | Description  |
| <b>MEGR-6121-05</b>           | High Pressure Fixed Reg 5PSI - 1/4" FNPT Inlet/Outlet  |
| <b>MEGR-6121-10</b>           | High Pressure Fixed Reg 10PSI - 1/4" FNPT Inlet/Outlet |
| <b>MEGR-6121-20</b>           | High Pressure Fixed Reg 20PSI - 1/4" FNPT Inlet/Outlet |
| <b>MEGR-6121-30</b>           | High Pressure Fixed Reg 30PSI - 1/4" FNPT Inlet/Outlet |
| <b>MEGR-6121-40</b>           | High Pressure Fixed Reg 40PSI - 1/4" FNPT Inlet/Outlet |
| <b>MEGR-6121-50</b>           | High Pressure Fixed Reg 50PSI - 1/4" FNPT Inlet/Outlet |
| <b>MEGR-6121-60</b>           | High Pressure Fixed Reg 60PSI - 1/4" FNPT Inlet/Outlet |

EXCELA-FLO™ REGULATORS



Tested in the U.S.A

The **MEGR-164 Series** adjustable high-pressure regulators offer a wide selection of available pressure ranges. High pressure regulators are typically used to reduce tank pressure to an intermediate pressure for use by another regulator. They may be used as high pressure regulators on distribution systems when used in conjunction with first-stage downstream regulators.

When equipped with an integral relief valve (MEGR-164SR Series), the regulator may be used as a final-stage regulator on high pressure systems. It may also be used as a first-stage regulator when set at 10 PSIG (0,69 bar) or less. The 1/4"-inch FNPT tapped side outlet can be used to install a pressure gauge or a hydrostatic relief valve. This series contains brass materials that are not compatible with anhydrous ammonia service.

**SPECIFICATIONS**

- Type:** Adjustable/ PSI
- Max. Inlet Pressure:** 250 PSI
- Inlet Connection:** 1/2" FNPT or 3/4" FNPT
- Outlet Connection:** 1/2" FNPT or 3/4" FNPT
- Exterior Finish:** Gray Urethane
- Regulator Spring:** Steel
- Stem Guide/Disk Holder:** Stainless Steel
- Diaphragm:** Fabric Reinforced Nitrile (NBR)
- Bonnet/Body Material:** Cast Aluminum
- Vent:** Non-Relieving
- Operating Temperature Range:** -40° to 200° F
- Listings:** UL LISTED / UL 252



**MEGR-164 Series**

| Part No.       | Description   | Outlet Pressure Setting, PSIG | Outlet Adjustment Range, PSIG | BTU/H * LPG @ 60 PSI Inlet | BTU/H * LPG @ 100 PSI Inlet |
|----------------|---|-------------------------------|-------------------------------|----------------------------|-----------------------------|
| MEGR-164/33    | 1/2" FNPT x 1/2" FNPT Adjustable High Pressure Regulator                          | 10                            | 0-30                          | 6,098,000                  | 6,800,000                   |
| MEGR-164/35    |   | 20                            | 0-30                          | 6,400,000                  | 8,335,000                   |
| MEGR-164/36    |   | 40                            | 0-60                          | 6,100,000                  | 9,145,000                   |
| MEGR-164/222   |   | 50                            | 0-125                         | 4,900,000                  | 7,225,000                   |
| MEGR-164SR/21  | 1/2" FNPT x 1/2" FNPT Adjustable High Pressure Regulator w/ Internal Relief Valve | 10                            | 0-15                          | 4,675,000                  | 7,825,000                   |
| MEGR-164SR/22  |   | 15                            | 0-30                          | 3,050,000                  | 4,125,000                   |
| MEGR-164SR/23  |   | 20                            | 0-30                          | 3,405,000                  | 4,755,000                   |
| MEGR-164-6/33  | 3/4" FNPT x 3/4" FNPT Adjustable High Pressure Regulator                          | 10                            | 0-30                          | 9,150,000                  | 10,875,000                  |
| MEGR-164-6/35  |   | 20                            | 0-30                          | 10,105,000                 | 12,400,000                  |
| MEGR-164-6/36  |   | 40                            | 0-60                          | 9,960,000                  | 13,415,000                  |
| MEGR-164-6/222 |   | 50                            | 35-100                        | 4,575,000                  | 11,890,000                  |

\* BTU/H Capacity @ 20% Droop

RECOMMENDED TO USE WITH EXTERNAL PRESSURE RELIEF DEVICE SUCH AS MEGR-1290 SERIES



# HIGH PRESSURE INDUSTRIAL

## HIGH TEMPERATURE

The **MEGR-1584/MEGR-1586 Series** is a highly reliable and accurate adjustable high-pressure regulator designed to offer a wide selection of available pressure ranges for LPG and NH<sub>3</sub> applications. With models designed to reduce container pressure to between 3PSI-125PSI coupled with the high BTU delivery capacity, this regulator series is perfect for a wide range of high demand industrial/commercial LPG applications such as temporary heat, grain drying, asphalt heaters, agriculture and manufacturing process applications along with alternate trim construction models for industrial NH<sub>3</sub> Applications.

All models feature a convenient factory plugged ¼"FNPT tapped auxiliary port allowing for easy installation of a pressure gauge or test port.

Models available with three different seal trim levels for LPG, NH<sub>3</sub> and High temperature applications:

Nitrile - Standard LPG Service (-40o – 170oF.)

FKM - High Temperature LPG Service (0o – 300oF.)

NBR/PTFE - NH<sub>3</sub> Service (-40o – 170oF.)



**MEGR-1584 Series**  
Standard / High Temp  
LPG Service



**MEGR-AA1586 Series**  
NH<sub>3</sub> Service

### SPECIFICATIONS

**Type:** Adjustable/ PSI

**Max. Inlet Pressure:** 400 PSI

**Inlet Connection:** 1/2", 3/4" or 1" FNPT

**Outlet Connection:** 1/2", 3/4" or 1" FNPT

**Exterior Body Finish:** Red Urethane: Standard/High Temp Models; Green Urethane: NH<sub>3</sub> Models;

**Body Exterior Finish:** Gray Urethane

**Regulator Spring:** Steel / Stainless Steel

**Stem Guide/Disk Holder:** Stainless Steel

**Diaphragm:** Fabric Reinforced Nitrile (NBR) for standard, FKM for High Temp., NBR with PTFE for NH<sub>3</sub>

**Bonnet/Body Material:** Die Cast Aluminum

**Vent:** Non-Relieving

**Listings:** UL LISTED / UL 141

| Part No.        | Service | Inlet & Outlet Connections | Recommended Delivery Pressure Range (PSIG) | Capacity determined @ set pressure of PSIG* | Flow Capacity**            |
|-----------------|---------|----------------------------|--|---|----------------------------|
| MEGR-1584VN     | LP-Gas  | 1/2" FNPT                  | 3-30                                       | 20  | 11,000,000 BTU/hr. LPG     |
| MEGR-1584VL     |         |                            | 25-50                                      | 30  | 14,500,000 BTU/hr. LPG     |
| MEGR-1584VH     |         |                            | 45-125                                     | 60  | 16,000,000 BTU/hr. LPG     |
| MEGR-H1584VN    |         |                            | 3-30                                       | 20  | 11,000,000 BTU/hr. LPG     |
| MEGR-H1584VL    |         |                            | 25-30                                      | 30  | 14,500,000 BTU/hr. LPG     |
| MEGR-AA1584VW   |         |                            | NH <sub>3</sub>                            | 1/2" FNPT                                   | 3-25                       |
| MEGR-AA1584VL   | 20-50   | 30                         |  |   | 9,000 CFH NH <sub>3</sub>  |
| MEGR-AA1584NH   | 45-125  | 60                         |  |   | 10,500 CFH NH <sub>3</sub> |
| MEGR-1586VN/6   | LP-Gas  | 3/4" FNPT                  | 3-30                                       | 20  | 15,000,000 BTU/hr. LPG     |
| MEGR-1586VL/6   |         |                            | 25-50                                      | 30  | 16,300,000 BTU/hr. LPG     |
| MEGR-1586VH/6   |         |                            | 45-125                                     | 60  | 16,300,000 BTU/hr. LPG     |
| MEGR-H1586VN/6  |         |                            | 3-30                                       | 20  | 15,000,000 BTU/hr. LPG     |
| MEGR-H1586VL/6  |         |                            | 25-50                                      | 30  | 16,300,000 BTU/hr. LPG     |
| MEGR-AA1586VW/6 |         |                            | NH <sub>3</sub>                            | 3/4" FNPT                                   | 3-25                       |
| MEGR-AA1586VL/6 | 20-50   | 30                         |  |   | 10,500 CFH NH <sub>3</sub> |
| MEGR-AA1586VH/6 | 45-125  | 60                         |  |   | 11,000 CFH NH <sub>3</sub> |
| MEGR-1586VN/8   | LP-Gas  | 1" FNPT                    | 3-30                                       | 20  | 15,000,000 BTU/hr. LPG     |
| MEGR-1586VL/8   |         |                            | 25-50                                      | 30  | 16,300,000 BTU/hr. LPG     |
| MEGR-1586VH/8   |         |                            | 45-125                                     | 60  | 16,300,000 BTU/hr. LPG     |
| MEGR-H1586VN/8  |         |                            | 3-30                                       | 20  | 15,000,000 BTU/hr. LPG     |
| MEGR-H1586VL/8  |         |                            | 25-50                                      | 30  | 16,300,000 BTU/hr. LPG     |
|                 |         |                            |  |   |                            |

\* Set pressure is established with 100 PSIG inlet pressure and a flow of 500,000 BTU/hr. propane for LPG service and 180 CFH NH<sub>3</sub>

\*\* Capacity determined at 100 PSIG inlet, set pressure note on chart at 20% droop

# HIGH PRESSURE

The **MEGR-11301F** is a reliable and accurate regulator making it ideal for numerous high pressure applications. This multi-purpose regulator can be used as a pilot supply or pressure-loading regulator where high pressure operating medium must be reduced for use by gas regulator pilots or pressure-loaded regulators. Its rugged design and multiple outlet ports offer versatility for a wide variety of applications.

## SPECIFICATIONS

- Type:** Adjustable / PSI
- Max. Inlet Pressure:** 5500 PSIG
- Inlet Connection:** 1/4" FNPT (1 Port)
- Outlet Connection:** 1/4" FNPT (3 Ports)
- Exterior Finish:** Brass
- Bonnet / Body Material:** Brass
- Bottom Cap and Spring Case:** Brass
- Gasket:** Nitrile (NBR)
- Valve Spring:** Stainless Steel
- Diaphragm:** Stainless Steel
- Valve Disks:** Nylon
- Vent:** 4 Holes (5/32" each)
- Temp. Range:** -40° F. / 225° F.



| Part No.           | Description             | Inlet (1 Port)/<br>Outlet (3 Ports) | Outlet Pressure<br>Range (PSIG) |
|--------------------|-------------------------|-------------------------------------|---------------------------------|
| <b>MEGR-11301F</b> | High Pressure Regulator | 1/4" FNPT                           | 0-120                           |

# LIQUID BACKPRESSURE/RELIEF VALVE

The **MEGR-198H Series**, liquid service valves are direct-operated relief valves for use on relief and backpressure applications involving large LP-Gas pumping systems and vaporizers. Internal pressure registration eliminates the need for a control line.

## SPECIFICATIONS

- Type:** Adjustable / PSI
- Orifice Material:** Stainless Steel
- Max. Inlet Pressure:** 300 PSIG
- Regulator Spring:** Plated Steel
- O-Ring Seat:** Nitrile (NBR)
- Exterior Finish:** Gray Powder Coat
- Diaphragm:** Stainless Steel
- Body Material / Spring Case:** Iron

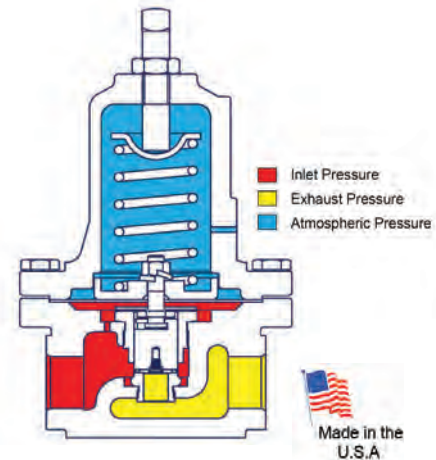

| Part No.            | Inlet/Outlet<br>Size | Relief Pressure Setting<br>PSIG (BAR) | Outlet Range PSIG (BAR) | Relief Capabilities GPM/LPG |                          |
|---------------------|----------------------|---------------------------------------|-------------------------|-----------------------------|--------------------------|
|                     |                      |                                       |                         | 10 PSI Over<br>Set P oint   | 50 PSI Over<br>Set Point |
| <b>MEGR-198H-22</b> | 3/4" FNPT            | 100 (6.9)                             | 70 to 140 (4.8 to 9.7)  | 49                          | 93                       |
| <b>MEGR-198H-30</b> | 1" FNPT              | 100 (6.9)                             | 70 to 140 (4.8 to 9.7)  | 49                          | 93                       |
| <b>MEGR-198H-31</b> | 1" FNPT              | 175                                   | 130-200                 | 52                          | 109                      |



# COMMERCIAL / INDUSTRIAL FIRST STAGE / HIGH PRESSURE

The **MEGR-1627 Series** commercial/industrial regulator is a large capacity, high pressure unit for use in conjunction with MEGR-CS1200 or MEGR-S1202 Series regulators. It can also be used on final-stage (PSI to PSI) service. The diaphragm case and/or regulator body on the MEGR-1627 Series can be rotated in any of four positions to allow installation in locations with limited space. Available with a monitor or integral relief valve. The MEGR-1627 Series is perfectly suited for jurisdictional systems, grain dryers, direct fired vaporizers or other high capacity service applications.

The **MEGR-1630 Series** First Stage / Industrial regulators are large capacity, high pressure units for use in conjunction with MEGR-S1202 Series regulators. They can also be used on final stage (pounds-to-pounds) service. These regulators are best suited for industrial applications where high flow capacity is required.

## SPECIFICATIONS

- Type:** Adjustable / PSI  
**Orifice Diameter:** 3/8" or 1/2"  
**Orifice Material:** Aluminum  
**Max. Inlet Pressure:** 250 PSI  
**Regulator Spring:** Steel  
**Stem Guide / Disk Holder:** Stainless Steel  
**Valve Stem:** Steel  
**Exterior Finish:** Grey Powder Coat  
**Diaphragm:** Fabric Reinforced Nitrile (NBR)  
**Bonnet Cap & Housing/Body Material:** Cast Aluminum/ Iron  
**Temp. Range:** -20° F. / 180° F.  
**Listings:** Select models are UL Listed / UL 144

**MEGR-1630-104/78**



**MEGR-1627 Series**



EXCELA-FLO™ REGULATORS

| Part No.         | Description                                      | Inlet/Outlet | Orifice | PSIG Outlet Set Point | PSIG Outlet Range | BTU/H LPG @ 100 PSI Inlet | BTU/H LPG @ 20 PSI Inlet |
|------------------|--|--------------|---------|-----------------------|-------------------|---------------------------|--------------------------|
| MEGR-1627/497    | First Stage High Pressure Regulator              | 1" FNPT      | 1/2"    | 20                    | 15-40             | 36,600,000                | 6,050,000                |
| MEGR-1627/576    |  | 2" FNPT      | 1/2"    | 10                    | 5-20              | 45,000,000                | 6,003,000                |
| MEGR-1627/5810*  |  | 3/4" FNPT    | 3/8"    | 10                    | 5-20              | 11,700,000                | 4,700,000                |
| MEGR-1627/6210*  |  | 3/4" FNPT    | 1/2"    | 10                    | 5-20              | 12,400,000                | 6,700,000                |
| MEGR-1627/7710   |  | 1" FNPT      | 1/2"    | 10                    | 5-20              | 25,100,000                | 6,900,000                |
| MEGR-1627B/7710* | First Stage High Pressure - Perpendicular Body   | 1" FNPT      | 1/2"    | 10                    | 5-20              | 25,100,000                | 6,900,000                |
| MEGR-1627M/267   | First Stage High Pressure Regulator - w/ Monitor | 2" FNPT      | 1/2"    | 10                    | 5-20              | 36,100,000                | 6,003,000                |
| MEGR-1627M/471   |  | 1" FNPT      | 1/2"    | 10                    | 5-20              | 25,100,000                | 6,900,000                |
| MEGR-1627R/113   | First Stage High Pressure w/ Relief              | 3/4" FNPT    | 3/8"    | 10                    | 5-20              | 9,800,000                 | 4,200,000                |
| MEGR-1627V/5810  | First Stage High Pressure - FKM construction **  | 3/4" FNPT    | 3/8"    | 10                    | 5-20              | 11,700,000                | 4,700,000                |
| MEGR-1627V/7710  |  | 1" FNPT      | 1/2"    | 10                    | 5-20              | 25,100,000                | 6,900,000                |

\* UL Listed / UL 144

\*\* For high temperature applications such as vaporizers

| Part No.         | Description           | Inlet/Outlet | Orifice | PSIG Outlet Set Point | Outlet PSIG Range | *SCFH/HR LPG | BTU/H LPG @ 100 PSI Inlet | BTU/H LPG @ 20 PSI Inlet |
|------------------|-----------------------|--------------|---------|-----------------------|-------------------|--------------|---------------------------|--------------------------|
| MEGR-1630-104/78 | First Stage Regulator | 2" FNPT      | 1/2"    | 10                    | 8-20              | 18,900       | 47,000,000                | 7,700,000                |

Note: Other configurations and materials available upon request.



# SECOND STAGE / LOW PRESSURE

The **MEGR-S1202/MEGR-CS1200 Series** commercial/industrial regulators are large capacity, low pressure second stage units for installation at schools, bakeries, and similar applications. They contain a limited capacity internal relief valve and can be used in conjunction with either MEGR-1627 Series or MEGR-1630 Series high-pressure regulators.

For high capacity installations, the MEGR-1289H Series relief valve is required to be installed in the downstream system.

**MEGR-1HSRL Series:** Offers a full size high capacity light commercial type regulator with an adjustment range from 6-14" WC (factory set @ 11" WC), a heavy duty cast iron body with a universal body to bonnet union for fast relocation of inlet to outlet vent location. These light commercial second stage regulators are used to reduce outlet pressures from first stage regulators (normally 10 PSI) to 11" WC.

## SPECIFICATIONS

- Type:** Adjustable / Inches WC or PSI
- Orifice Diameter:** 3/8", 5/16", 1/2" or 1"
- Max. Inlet Pressure:** 25 PSIG
- Body Material:** Cast Iron
- Regulator Spring:** Music Wire
- Spring Case/ Stem Guide/ Disk Holder:** Aluminum
- Disk/ Diaphragm and O-Ring:** Fabric Reinforced Nitrile (NBR)
- Closing Cap Gasket:** Neoprene



**MEGR-1HSRL Series**



**MEGR-CS1200 Series**



**MEGR-S1202 Series**



| Part No.                | Description                         | Inlet/Outlet Connection Style | Orifice | Outlet Pressure Range | Outlet Pressure Setting | Maximum Operating Inlet Pressure | BTU/H LPG @ 25 PSI Inlet | BTU/H LPG @ 10 PSI Inlet |
|-------------------------|-------------------------------------|-------------------------------|---------|-----------------------|-------------------------|----------------------------------|--------------------------|--------------------------|
| <b>MEGR-1HSRL-BFC</b>   | Second Stage Low Pressure Regulator | 3/4" FNPT                     | 3/8"    | 6-14" WC              | 11" WC                  | 40 PSIG                          | —                        | 2,000,000                |
| <b>MEGR-1HSRL-CFC</b>   |                                     | 1" FNPT                       | 3/8"    | 6-14" WC              | 11" WC                  | 40 PSIG                          | —                        | 2,500,000                |
| <b>MEGR-CS1200R6EC1</b> |                                     | 3/4" FNPT                     | 1/2"    | 6-14" WC              | 11" WC                  | 25 PSIG                          | 2,100,000                | 1,600,000                |
| <b>MEGR-CS1200R6EC3</b> |                                     | 1" FNPT                       | 1/2"    | 6-14" WC              | 11" WC                  |                                  | 2,500,000                | 1,900,000                |
| <b>MEGR-CS1200R6EC6</b> |                                     | 1-1/4" FNPT                   | 1/2"    | 6-14" WC              | 11" WC                  |                                  | 3,100,000                | 2,800,000                |
| <b>MEGR-CS1200R7EC1</b> |                                     | 3/4" FNPT                     | 5/16"   | 6-14" WC              | 7" WC                   |                                  | *1,250,000               | *985,000                 |
| <b>MEGR-CS1200R7EC3</b> |                                     | 1" FNPT                       | 5/16"   | 6-14" WC              | 7" WC                   |                                  | *1,620,000               | *1,525,000               |
| <b>MEGR-S1202G-BNC</b>  |                                     | 1-1/2" FNPT                   | 1"      | 9 - 18" WC            | 11" WC                  |                                  | 14,700,000               | 10,800,000               |
| <b>MEGR-S1202G-CNC</b>  |                                     | 2" FNPT                       | 1"      | 9 - 18" WC            | 11" WC                  |                                  | 30,000,000               | 23,000,000               |
| <b>MEGR-S1202H-CNK</b>  |                                     | 2" FNPT                       | 1"      | 1.5-3.25 PSI          | 2 PSI                   |                                  | 22,200,000               | 10,300,000               |

Note: Other configurations and materials available upon request.  
WC = Water Column

\* Flow Rates listed in BTU Natural Gas





# COMMERCIAL / INDUSTRIAL

## SECOND STAGE

The **MEGR-1133 Series Pressure Regulator**: Manual, direct acting, self-operating, spring loaded, adjustable regulator. It is used in applications where pressure reduction is required. The regulator will reduce the risk of “shock” from abrupt changes of downstream conditions. This can help prevent safety equipment from shutting an operation down. The MEGR-1133 is equipped with external pressure registration; an external control line is needed to connect the output pressure port with the diaphragm chamber. The MEGR-1133 utilizes a balance diaphragm to reduce the effects of supply pressure changes on the output pressure. The external pressure registration of the standard MEGR-1133 also allows it to be used as a monitor regulator.

### SPECIFICATIONS

- Maximum Operating Inlet:** 60 PSIG
- Maximum Emergency Inlet:** 125 PSIG
- Maximum Operating Outlet:**
  - MEGR-1133L - 2 PSIG
  - MEGR-1133H - 10 PSIG
- End Connections:** 2" NPT
- Temperature Range:** -40°F to 200°F



### MATERIALS OF CONSTRUCTION

- Body:** Iron
- Bonnet:** Aluminum
- Orifice:** Aluminum
- Regulator Spring:** Steel
- Stem Guide/Disk Holder:** Aluminum
- Valve Stem:** Aluminum
- Diaphragm:** Fabric Reinforced Nitrile (NBR)
- Exterior Finish:** Gray Powder Coat

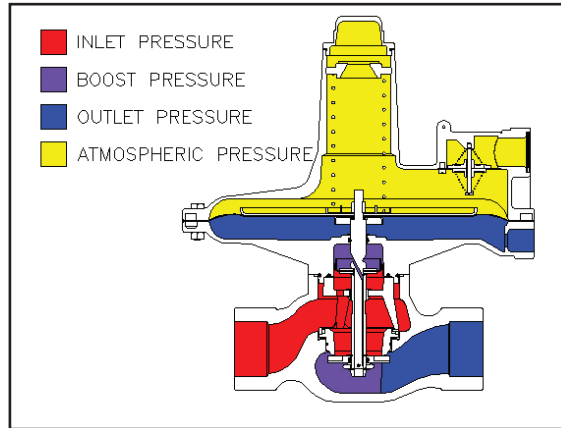

EXCELA-FLO™ REGULATORS

| Part No.     | Description            | Inlet/Outlet | Orifice | Range of Adjustment | Outlet Set Point | BTU/H LPG @ 10 PSI Inlet | BTU/H LPG @ 20 PSI Inlet |
|--------------|------------------------|--------------|---------|---------------------|------------------|--------------------------|--------------------------|
| MEGR-1133H-2 | Second Stage Regulator | 2" FNPT      | 2"      | 2-5 PSI             | 2 PSI            | 27,405,000               | 52,700,000               |
| MEGR-1133H-3 | Second Stage Regulator | 2" FNPT      | 2"      | 5-10 PSI            | 5 PSI            | 22,300,000               | 41,600,000               |
| MEGR-1133L-4 | Second Stage Regulator | 2" FNPT      | 2"      | 8.5"-18" WC         | 14" WC           | 45,600,000               | 77,100,000               |
| MEGR-1133L-6 | Second Stage Regulator | 2" FNPT      | 2"      | .75-2 PSI           | 2 PSI            | 46,700,000               | 77,100,000               |

Note: Other configurations available upon request



# VAPOR BACKPRESSURE / RELIEF VALVES

Available in settings ranging between 1 to 75 PSIG for the 3/4" & 1" models and 7"WC to 15 PSI for the 2" models. The **MEGR-1289H Series** relief valve is a throttling relief valve used downstream of pressure regulators to protect the downstream system from overpressure. A smooth throttling action minimizes pressure surges in the system during emergency operation.

This unit features a pilot tube booster to achieve the highest possible relief capacity with a minimum buildup of system pressure.

The MEGR-1289H Series relief valve is installed between large second stage regulators and the burner to provide high capacity relief. They are ideal for low pressure settings due to the increased sensitivity provided by the large diaphragm area. Suitable as a pressure high capacity relief device when installed between a first and second stage regulator.

## SPECIFICATIONS

**Type:** Adjustable / Inches WC or PSI

**Max. Inlet Pressure:** 100 PSIG (1" Body)  
25 PSIG (2" Body)

**Spring:** Plated Steel

**Exterior Finish:** Gray Powder Coat

**Diaphragm:** Fabric Reinforced Nitrile (NBR)

**Bonnet/Body Material:** 1" - All Aluminum  
2" - Aluminum Bonnet / Iron Body

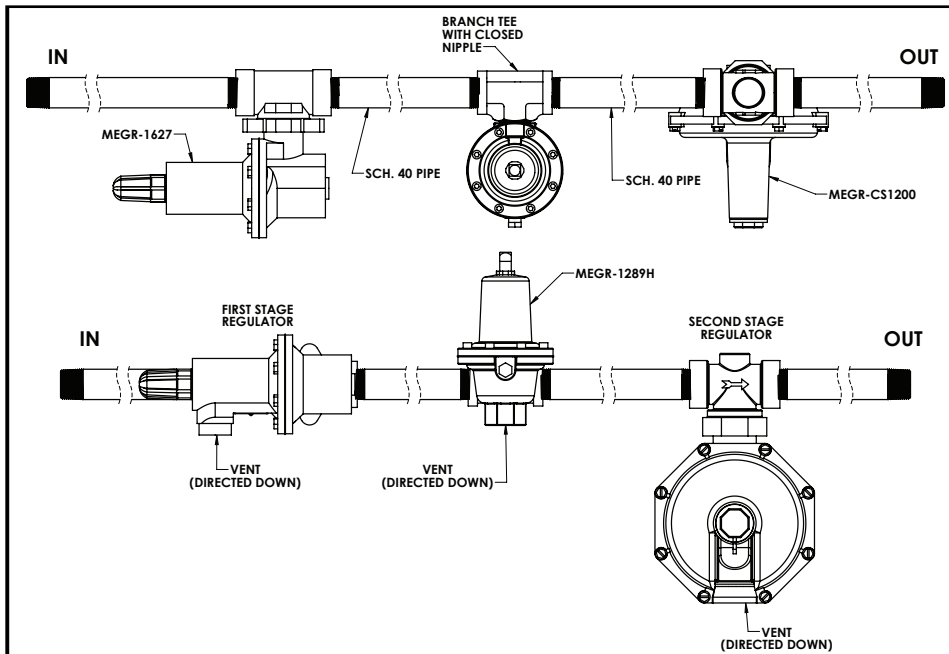

| Part No.      | Description                           | Inlet/ Outlet       | Max. Inlet PSIG | Set Point | Set Point Range | SCFH / Propane |
|---------------|---------------------------------------|---------------------|-----------------|-----------|-----------------|----------------|
| MEGR-1289H/1  | Back Pressure Regulator/ Relief Valve | 2" FNPT             | 25              | 9" WC     | 7-18" WC        | 55,000         |
| MEGR-1289H/2  | Back Pressure Regulator/ Relief Valve | 2" FNPT             | 25              | 1 PSIG    | .5-2.25 PSIG    | 55,500         |
| MEGR-1289H/3  | Back Pressure Regulator/ Relief Valve | 2" FNPT             | 25              | 3 PSIG    | 1.75-7 PSIG     | 58,000         |
| MEGR-1289H/4  | Back Pressure Regulator/ Relief Valve | 2" FNPT             | 25              | 6 PSIG    | 4-10 PSIG       | 58,500         |
| MEGR-1289H/5  | Back Pressure Regulator/ Relief Valve | 2" FNPT             | 25              | 12 PSIG   | 10-15 PSIG      | 61,000         |
| MEGR-1289H/41 | Back Pressure Regulator/ Relief Valve | 1" FNPT             | 100             | 2 PSIG    | 1-4.5 PSIG      | 45,500         |
| MEGR-1289H/42 | Back Pressure Regulator/ Relief Valve | 1" FNPT             | 100             | 8 PSIG    | 4-15 PSIG       | 46,000         |
| MEGR-1289H/43 | Back Pressure Regulator/ Relief Valve | 1" FNPT             | 100             | 15 PSIG   | 10-20 PSIG      | 48,000         |
| MEGR-1289H/49 | Back Pressure Regulator/ Relief Valve | 1" FNPT             | 100             | 25 PSIG   | 15-50 PSIG      | 49,000         |
| MEGR-1289HH-1 | Back Pressure Regulator/ Relief Valve | 1" FNPT             | 100             | 50 PSIG   | 45-75 PSIG      | 50,000         |
| MEGR-1290H/43 | Back Pressure Regulator/ Relief Valve | 3/4" FNPT X 1" FNPT | 100             | 15 PSIG   | 10-20 PSIG      | 40,000         |
| MEGR-1290H/49 | Back Pressure Regulator/ Relief Valve | 3/4" FNPT X 1" FNPT | 100             | 25 PSIG   | 15-50 PSIG      | 50,000         |

Note: Other configurations and materials available upon request.

# COMMERCIAL/INDUSTRIAL

## PILOT OPERATED

The **MEGR-199 Series Industrial Regulators**: Large capacity, pilot operated, low or high pressure units for use in applications with loads demanding up to 75,000,000 BTU/H capacity. These regulators are best suited for industrial applications where high flow capacity and a downstream monitor control line can be applied. The MEGR-199 series provides exceptional downstream control while operating at very high capacities with minimal droop under varying flow and inlet pressures.

### SPECIFICATIONS

- Type:** Adjustable/PSI/WC
- Max. Inlet Pressure:** 150-300 PSI
- Exterior Finish:** Gray Powder Coat
- Orifice Size:** 7/8" or 1-1/8"
- Orifice Material:** Stainless Steel
- Regulator Spring:** Steel
- Diaphragm Plate:** Steel
- Diaphragm:** Fabric Reinforced Nitrile (NBR)
- Body Material:** Iron
- Bonnet Cap & Bonnet:** Iron

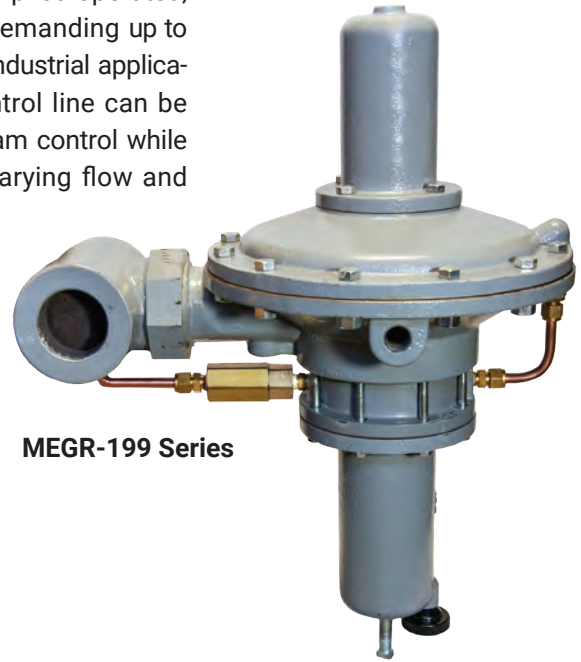

**MEGR-199 Series**

EXCELA-FLO™ REGULATORS

| Part No.        | Description                                    | Inlet/Outlet | Max. Pressure | Orifice | Range of Adjustment | Outlet Set Point | BTU/H LPG @ 20 PSI Inlet <sup>(1)</sup> |
|-----------------|--|--------------|---------------|---------|---------------------|------------------|---|
| MEGR-199-501P   | Pilot Operated Low Pressure Regulator          | 2" FNPT      | 150           | 1-1/8"  | 7" WC-2 PSI         | 1                | 48,825,000                              |
| MEGR-199-502P   | Pilot Operated Low Pressure Regulator          | 2" FNPT      | 150           | 1-1/8"  | 1-5 PSI             | 5                | 55,125,000                              |
| MEGR-199-503P   | Pilot Operated Low Pressure Regulator          | 2" FNPT      | 150           | 1-1/8"  | 2-10 PSI            | 10               | 61,425,000                              |
| MEGR-199-504P   | Pilot Operated Low Pressure Regulator          | 2" FNPT      | 150           | 1-1/8"  | 5-15 PSI            | 15               | 63,000,000                              |
| MEGR-199-510P   | Pilot Operated High Pressure Regulator         | 2" FNPT      | 250           | 7/8"    | 7" WC-2 PSI         | 1                | 29,295,000                              |
| MEGR-199-511P   | Pilot Operated High Pressure Regulator         | 2" FNPT      | 250           | 7/8"    | 1-5 PSI             | 5                | 33,075,000                              |
| MEGR-199-512P   | Pilot Operated High Pressure Regulator         | 2" FNPT      | 250           | 7/8"    | 5-15 PSI            | 15               | 37,800,000                              |
| MEGR-199-513P   | Pilot Operated High Pressure Regulator         | 2" FNPT      | 250           | 7/8"    | 2-10 PSI            | 10               | 36,225,000                              |
| MEGR-199-515P   | Pilot Operated High Pressure Regulator         | 2" FNPT      | 250           | 7/8"    | 10-20 PSI           | 20               | 40,950,000                              |
| MEGR-199-903P   | Pilot Operated High Pressure Regulator         | 2" FNPT      | 250           | 7/8"    | 10-65 PSI           | 30               | 44,100,000                              |
| MEGR-199-502PH  | Pilot Operated High Pressure Regulator         | 2" FNPT      | 300           | 1-1/8"  | 1-5 PSI             | 5                | 55,125,000                              |
| MEGR-199-503PH  | Pilot Operated High Pressure Regulator         | 2" FNPT      | 300           | 1-1/8"  | 2-10 PSI            | 10               | 61,425,000                              |
| MEGR-199-504PH  | Pilot Operated High Pressure Regulator         | 2" FNPT      | 300           | 1-1/8"  | 5-15 PSI            | 15               | 63,000,000                              |
| MEGR-199-505PH  | Pilot Operated High Pressure Regulator         | 2" FNPT      | 300           | 1-1/8"  | 10-20 PSI           | 20               | 67,725,000                              |
| MEGR-199-901PH  | Pilot Operated High Pressure Regulator         | 2" FNPT      | 300           | 1-1/8"  | 10-65 PSI           | 30               | 74,025,000                              |
| MEGR-199M-504PH | Monitor Pilot Operated High Pressure Regulator | 2" FNPT      | 300           | 1-1/8"  | 5-15 PSI            | 15               | 42,650,000                              |
| MEGR-199M-505PH | Monitor Pilot Operated High Pressure Regulator | 2" FNPT      | 300           | 1-1/8"  | 10-20 PSI           | 20               | 67,725,000                              |
| MEGR-199M-901PH | Monitor Pilot Operated High Pressure Regulator | 2" FNPT      | 300           | 1-1/8"  | 10-65 PSI           | 30               | 74,025,000                              |

(1) Capacity based on inlet pressures 20 PSIG greater than outlet pressure set point and 20% droop.



# COMMERCIAL/INDUSTRIAL OPTIONS

| MEGR-1627 Series First Stage Regulator Options Chart |                |               |              |         |                  |        |
|--|----------------|---------------|--------------|---------|------------------|--------|
| Base   | Relief/Monitor |               | Body Options | Orifice | Adjustment Range | Spring |
| P/N  | Code           | Description   | Description  | Size    | Description      | Color  |
| MEGR-1627  | M              | Monitor       | 3/4"FNPT     | 1/8"    | 5-20PSI          | Yellow |
|  | R              | Token Relief  | 1"FNPT       | 3/16"   | 15-40PSI         | Green  |
|  | -              | Non-Relieving | 2"FNPT       | 1/4"    | 10-95PSI         | Blue   |
|  |                |               |              | 3/8"    | 70-150PSI        | Red    |
|  |                |               | 1/2"         |         |                  |        |

| MEGR-1289/1290 Series Commercial Regulator Relief Valve Options Chart |          |             |              |                  |
|---|----------|-------------|--------------|------------------|
| Base  | Pressure |             | Body Options | Adjustment Range |
| P/N   | Code     | Description | Description  | Description      |
| MEGR-1289   | H        | High        | 1"FNPT       | 7-18"WC*         |
|   | L        | Low         | 2"FNPT       | 10-14"WC**       |
|   |          |             |              | .5-2.25PSI*      |
| MEGR-1290   | H        | High        | 3/4"FNPT     | 1.75-7PSI*       |
|   | L        | Low         | -            | 4-10PSI*         |
|   |          |             |              | 10-15PSI*        |
|   |          |             |              | 1-4.5PSI**       |
|   |          |             |              | 4-15PSI**        |
|   |          |             |              | 10-20PSI**       |
|   |          |             |              | 15-50PSI**       |
|   |          |             | 45-75PSI***  |                  |

\* Note - Available In 2" Body Only.

\*\* Note - Available in 3/4" or 1" Body Only.

\*\*\* Note - Available in 3/4" or 1" HH Body Only.

| MEGR-1HSRL Series House Service Regulator P/N Configurator Chart |              |              |         |       |                  |             |
|--|--------------|--------------|---------|-------|------------------|-------------|
| Base   | Body Options |              | Orifice |       | Adjustment Range |             |
| P/N  | Code         | Description  | Code    | Size  | Code             | Description |
| MEGR-1HSRL   | B            | 3/4"FNPT     | C       | 1/8"  | A                | 3.5-6.5"WC  |
|  | C            | 1"FNPT       | D       | 3/16" | B                | 5-8.5"WC    |
|  | B/C          | 3/4 x 1"FNPT | E       | 1/4"  | C                | 6-14"WC     |
|  |              |              | F       | 3/8"  | D                | 12-33"WC    |
|  |              |              | G       | 1/2"  | E                | .5-2PSI     |
|  |              |              |         |       | F                | .5-3PSI     |

| MEGR-CS1200 Series Second Stage Commercial Regulator P/N Configurator Chart |         |             |        |             |         |       |                  |             |              |             |
|---|---------|-------------|--------|-------------|---------|-------|------------------|-------------|--------------|-------------|
| Base  | Sensing |             | Relief |             | Orifice |       | Adjustment Range |             | Body Options |             |
| P/N   | Code    | Description | Code   | Description | Code    | Size  | Code             | Description | Code         | Description |
| MEGR-CS1200   | I       | Internal    | R      | Internal    | 1       | 1/8"  | A                | 3.5-6.5"WC  | C1           | 3/4"FNPT    |
|   |         |             |        |             | 2       | 3/16" | C                | 5-8.5"WC    | C3           | 1"FNPT      |
|   |         |             |        |             | 3       | 1/4"  | E                | 6-14"WC     | C6           | 1-1/4"FNPT  |
|   |         |             |        |             | 7       | 5/16" | F                | 12-33"WC    |              |             |
|   |         |             |        |             | 5       | 3/8"  | G                | .5-2PSI     |              |             |
|   |         |             |        |             | 6       | 1/2"  | H                | .5-3PSI     |              |             |
|   |         |             |        |             | 8       | 5/8"  | I                | 2-5PSI      |              |             |

| MEGR-S1202 Series Second Stage Commercial Regulator P/N Configurator Chart |          |             |              |             |         |         |                  |             |        |
|--|----------|-------------|--------------|-------------|---------|---------|------------------|-------------|--------|
| Base   | Pressure |             | Body Options |             | Orifice |         | Adjustment Range |             |        |
| P/N  | Code     | Description | Code         | Description | Code    | Size    | Code             | Description | Color  |
| MEGR-S1202   | G        | Low         | B            | 1-1/2"FNPT  | J       | 1/4"    | A                | 3.5-6.5"WC  | Red    |
|  | H        | High        | C            | 2"FNPT      | K       | 3/8"    | B                | 5-9"WC      | Black  |
|  |          |             |              |             | L       | 1/2"    | C                | 8.5-18"WC   | White  |
|  |          |             |              |             | M       | 3/4"    | D                | 14-30"WC    | Green  |
|  |          |             |              |             | N       | 1"      | J *              | 1-2PSI      | Blue   |
|  |          |             |              |             | O       | 1-3/16" | K *              | 1.5-3.25PSI | Orange |
|  |          |             |              |             |         |         | L *              | 2-5PSI      | Yellow |
|  |          |             |              |             |         |         | M *              | 2-5.5PSI    | Green  |

\* Note - Only Available In High Pressure Body Construction

| MEGR-1133 Series Second Stage Commercial Regulator Options Chart |          |             |              |                  |
|--|----------|-------------|--------------|------------------|
| Base   | Pressure |             | Body Options | Adjustment Range |
| P/N  | Code     | Description | Description  | Description      |
| MEGR-1133  | H        | High        | 2"FNPT       | 2-4"WC           |
|  | L        | Low         |              | 3.5-6"WC         |
|  |          |             |              | 5-9"WC           |
|  |          |             |              | 8.5-18"WC        |
|  |          |             |              | 14-28"WC         |
|  |          |             |              | .75-2PSI         |
|  |          |             |              | 1.5-3.25PSI*     |
|  |          |             |              | 2-5PSI*          |
|  |          |             |              | 5-10PSI*         |

\* Note - Only Available In H Body Configuration

| MEGR-199 Series Pilot Operated Commercial Regulator Options Chart |         |             |              |          |             |           |                  |
|---|---------|-------------|--------------|----------|-------------|-----------|------------------|
| Base  | Monitor |             | Body Options | Pressure |             | Orifice   | Adjustment Range |
| P/N   | Code    | Description | Description  | Code     | Description | Size      | Description      |
| MEGR-199  | M       | Monitor     | 2"FNPT       | P        | 250PSI      | 1/2"      | 3-12"WC          |
|   | -       | Standard    |              | PH       | 300PSI      | 5/8"      | 1-5PSI           |
|   |         |             | 3/4"         |          |             | 2-10PSI   |                  |
|   |         |             | 7/8"         |          |             | 5-15PSI   |                  |
|   |         |             | 1-1/8"       |          |             | 10-20PSI  |                  |
|   |         |             |              |          |             | 10-65PSI* |                  |

\*Note - Only Available in PH Body Configuration



# VALVE SAFETY WARNING

Marshall Excelsior Company (MEC) would like to provide you with information regarding the hazards associated with Liquefied Petroleum Gas (LPG) and anhydrous ammonia (NH<sub>3</sub>) equipment. All MEC products must be installed and maintained in accordance with NFPA 58 "Liquefied Petroleum Gas Code", NFPA 59 "Utility LP-Gas Plant Code" for LPG, and ANSI Standard K61.1 for NH<sub>3</sub>, as well as all other applicable state, federal and local requirements. In the interest of safety, all persons employed in handling LPG and NH<sub>3</sub> must be trained in proper handling and operating procedures.

MEC products are mechanical devices that are subject to wear, contaminants, corrosion, and aging of components made of materials such as rubber and metal. Over time these devices will eventually become inoperative. The safe service life of these products is affected by the environment and conditions of use that they are subjected to. MEC products have a long record of quality and service, so managers and service personnel must keep in mind the hazards that can arise from using aging devices that have outlived their safe service life.

## !!! WARNING !!!

**Contact with, or inhalation of liquid propane, anhydrous ammonia, and their vapors can cause serious injury and death! NH<sub>3</sub> and LPG must be released outdoors in air currents that will ensure dispersion to prevent exposure to people and livestock and in accordance with local regulations. LPG must be kept far enough from open flame or other sources of ignition to prevent fire or explosion! LPG vapor is heavier than air and will not disperse or evaporate rapidly if released in still air! An abundant supply of clean water must be readily available and easily accessible as a means of providing IMMEDIATE First Aid treatment for exposure to anhydrous ammonia.**



**WARNING:** These products contain a chemical known to the state of California to cause cancer and birth defects or reproductive harm

## !!! CAUTION !!!

- Always wear suitable eye protection, gloves and protective clothing when operating or servicing LPG and NH<sub>3</sub> equipment.
- Check seals, seats and Acme threads for wear and damage before use. Repair or replace all defective parts immediately.
- Always completely relieve system or line pressure prior to servicing equipment and plumbing.
- Use a suitable sealant on tapered pipe joints and always pressure test for leaks prior to returning to service.
- Always replace protective dust caps after use.
- To prevent the accidental opening of any valve, never carry or grasp a valve by its hand wheel or handle.
- To prevent accidental discharge, introducing contaminants and premature wear, never intentionally drag or drop a hose end valve.
- Use only the special wrenches designed for making 2-1/4" and 3-1/4" Acme valve connections.
- Regular inspection and maintenance is essential for continued safe operation.

There are developing trends in state legislation and proposed national legislation making the owner of products responsible for replacing products before they outlive their safe service life. LP-Gas dealers should be aware of such legislation as it affects them.

The contents of this publication are for informational purposes only. While every effort has been made to ensure accuracy, these contents are not to be construed as warranties or guarantees, expressed or implied, regarding the products or services described herein or for their use or applicability.

Marshall Excelsior Co. reserves the right to modify or improve the designs or specifications of such products at any time without notice.

The MEC™ logo is the trademark of Marshall Excelsior Co.

## Hose End and Filling Valves

Follow this procedure on every filling application in order to prevent hazardous conditions:

- Check hose end valve and filler valve for foreign materials and, if present, remove with extreme care. If foreign material cannot be safely removed, do not proceed with filling and replace valve.
- Make sure the Acme connector easily spins on by hand. Never use hammers or pipe wrenches to tighten Acme connections.
- If a leak is detected when filling is started, immediately stop the operation and follow procedures to correct the leaking condition.
- Before disconnecting a filler valve, close both the filler and hose end valve tightly and vent the trapped gas by (a) using the vent on the hose end valve or (b) slightly loosening coupling nut to vent the gas before disconnecting. Loosen the filler valve very slowly. If the gas does not stop venting, then there is a leak in the filler valve or hose end valve. Do not disconnect the filling connector. Make sure you are familiar with your companies' procedure for handling this hazardous situation and follow it carefully.

## Back Checks and Valves with Back Checks

Back checks limit flow to one direction. They are not intended to be a primary shut-off. Always fully close shut-off valves equipped with back checks when not in use.

## Excess Flows and Valves with Excess Flows

Excess flows check closed when their rated flow is exceeded. Always fully open a shut-off valve with an excess flow when in use.

## Quick Acting Filling Valves

Inspect valves daily to ensure locking mechanism is working properly.



# TURBO-FLO LE™ TRANSFER SYSTEM

The **Turbo-Flo LE™** (Low Emission) Transfer System is the industries most efficient and cost-effective way to transfer LP-Gas in bobtail, transport, railcar, and bulk plant applications. This product will pay for itself through gas savings during disconnect and its increased flow rate. While any part of this system is interchangeable with other standard systems, to receive maximum savings, all three products (LE Transfer Valve, LE Acme Adapter, and MEC Globe Valve) must be used simultaneously.

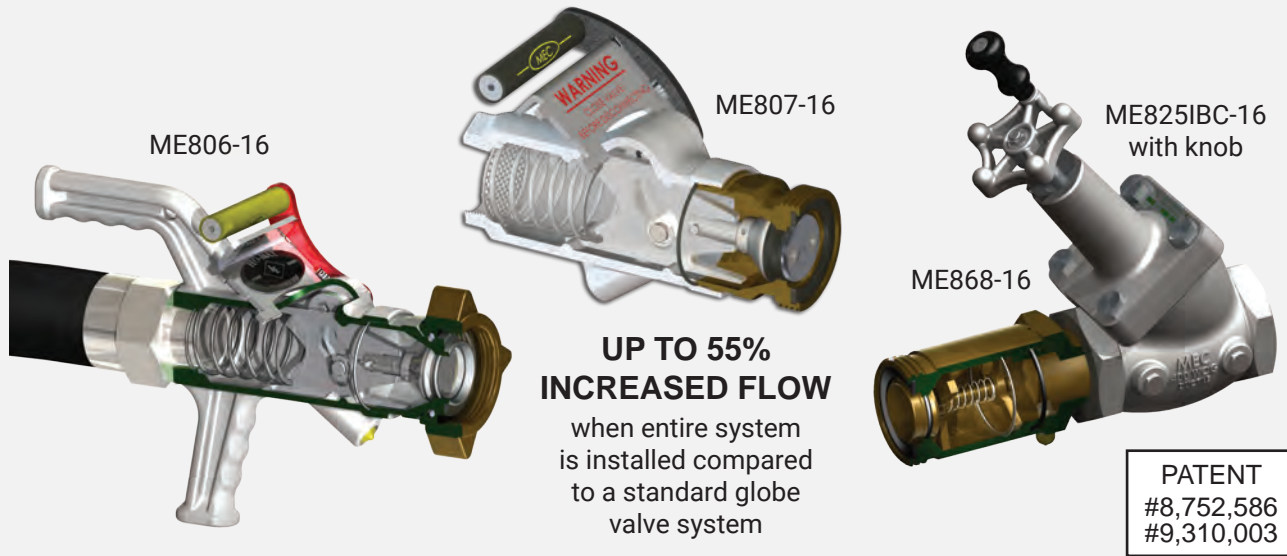

## LE TRANSFER VALVE - 2" FNPT X 3-1/4" F. ACME

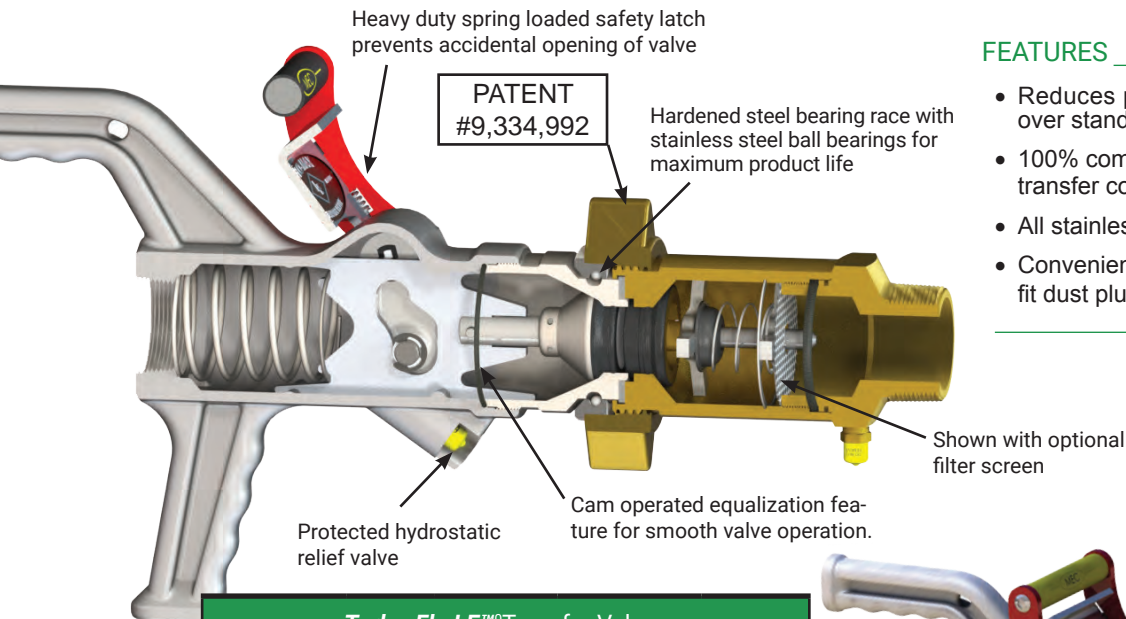

### FEATURES

- Reduces product emissions by 99.6% over standard valves
- 100% compatible with existing Acme transfer connections
- All stainless steel internal components
- Convenient carrying handles and custom fit dust plug with lanyard (not shown)

Pilot orifice allows the valve to equalize and open only when the valve is attached to the mating part. When the valve is not attached to the mating part, the valve cannot equalize and will not open.

| Turbo-Flo LE™ Transfer Valves |              |                  |                         |               |
|-------------------------------|--------------|------------------|-------------------------|---------------|
| Part No.                      | Inlet (FNPT) | Outlet (F. Acme) | Discharge at Disconnect | Material      |
| ME806-16                      | 2"           | 3-1/4"           | .09 CC                  | Ductile/Brass |
| ME806S-16*                    | 2"           | 3-1/4"           | .09 CC                  | Ductile/Steel |

\* Rated for LP-Gas & NH<sub>3</sub>

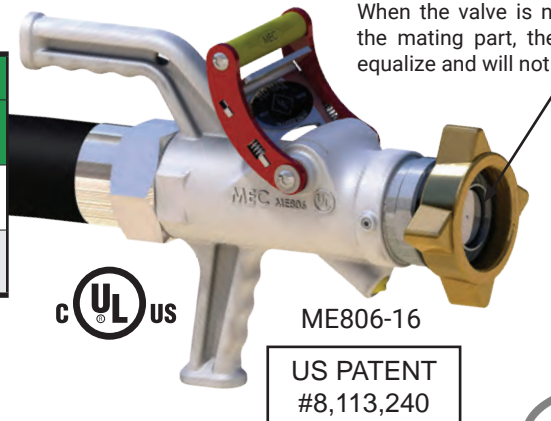

# TURBO-FLO LE™ TRANSFER SYSTEM

## LE TRANSFER VALVE - 2" MNPT X 3-1/4" M. ACME

FOR USE WITH LPG & LH3 TRANSFER SYSTEMS

This revolutionary system provides a safe, ergonomic and efficient solution to transfer applications while increasing productivity and dramatically reducing fugitive product emissions. For use with bobtail, transport, railcar and bulk plant applications.

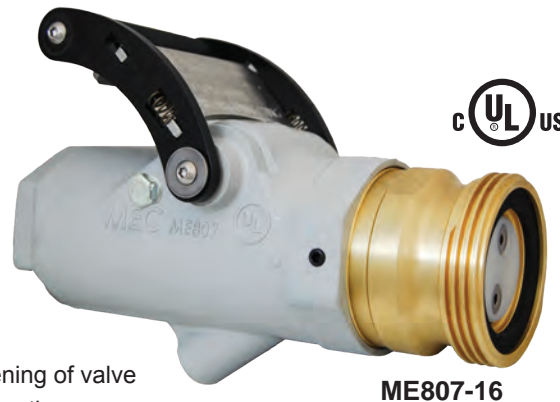

ME807-16

### FEATURES

- Reduces product emissions 99.6% over standard valve combinations
- 100% compatible with all existing acme transfer connections
- Heavy duty spring loaded safety latch prevents accidental opening of valve
- Cam operated vapor equalization feature for smooth valve operation
- All stainless internal components
- Factory installed hydrostatic relief valve
- Specially formulated low temperature valve seals for maximum performance and life under all operating conditions
- Integrated Back Check (IBC) feature to allow trapped liquid to be forced back upstream of the valve if liquid is trapped downstream of the valve seat
- Available with brass or steel acme connections
- Designed for bi-directional flow of product
- Integrated pilot feature allows the ME807 to equalize and open only when connected to mating connection ensuring maximum safety.



ME135

The ME135 discharge hose adapter allows transport hoses to be adapted to work with the ME807 LE Shutoff Valve while providing a flexible connection in the transport trailer hose bleed down lines.

| Turbo-Flo LE™ Transfer Valves |  |                         |               |
|-------------------------------|--|-------------------------|---------------|
| Part No.                      | Description  | Discharge at Disconnect | Material      |
| ME807-16                      | Low Emission Transfer Valve 2" FNPT x 3-1/4" M. Acme Fixed                       | 3.2 CC                  | Ductile/Brass |
| ME807S-16                     | Low Emission Transfer Valve 2" FNPT x 3-1/4" M. Acme Fixed                       | 3.2 CC                  | Ductile/Steel |
| Accessories                   |  |                         |               |
| Part No.                      | Description  |                         |               |
| ME134WR                       | 3-1/4"F.Acme x 2MPT Filler Coupling w/Retainer Ring & 3/8"FNPT Port-Brass/Steel  |                         |               |
| ME134SWR                      | 3-1/4"F.Acme x 2MPT Filler Coupling w/Retainer Ring & 3/8"FNPT Port-Steel/Steel  |                         |               |
| ME135                         | 3-1/4"F.Acme x 2MPT Filler Coupling w/Ring & Discharge Hose-Brass Nut/Steel Stem |                         |               |
| ME806-16                      | Low Emission Transfer Valve 2" FNPT x 3-1/4" F. Acme Swivel                      |                         |               |
| ME806S-16                     | Low Emission Transfer Valve 2" FNPT x 3-1/4" F. Acme Swivel                      |                         |               |
| ME807PIB                      | Smart Interlock Technology Sensor Bracket Assembly for ME807 Series              |                         |               |



# EXCELA-FLANGE™ SERIES

## LE TRANSFER VALVE - 4 BOLT TYPE B FLANGE X 3-1/4" M. ACME

FOR USE WITH LPG & NH<sub>3</sub> TRANSFER SYSTEMS

The **ME808-16 Series** valves feature our new modular **Excelsa-Flange™** 4-bolt inlet flange design that can be easily adapted to both NTP thread or socket weld type A companion flanges (ME840 & ME841 Series) ranging from 1-1/4" to 2" in diameter making it universal to piping sizes within this range. This innovative system allows installers the ability to eliminate unnecessary connections as well as possible leak points by integrating a convenient 4 bolt flange union at the valve inlet. The **Turbo-Flo LE™** system provides a safe, ergonomic and efficient solution for liquid or vapor transfer applications while increasing productivity and dramatically reducing fugitive product emissions. For use with bobtail, transport, railcar and bulk plant applications.



**ME808-16**

### FEATURES

- Universal 4 bolt inlet flange for built in union joint
- Reduces product emissions 99.6% over standard valve combinations
- 100% compatible with all existing acme transfer connections
- Heavy duty spring loaded safety latch prevents accidental opening of valve
- Cam operated vapor equalization feature for smooth valve operation
- All stainless internal components
- Factory installed hydrostatic relief valve
- Specially formulated low temperature valve seals for maximum performance and life under all operating conditions
- Integrated Back Check (IBC) feature to allow trapped liquid to be forced back upstream of the valve if liquid is trapped downstream of the valve seat.
- Available with brass or steel acme connections.

| Part No.          | Description   | Discharge at Disconnect | Material      | Mating Flange Type | Weight (lbs.) |
|-------------------|---|-------------------------|---------------|--------------------|---------------|
| <b>ME808-16</b>   | Low Emission Transfer Valve 4 Bolt Type B Flange x 3-1/4" M. Acme Fixed             | 3.2 CC                  | Ductile/Brass | A                  | 12.3          |
| <b>ME808A-16</b>  | Low Emission Transfer Valve 4 Bolt Type B Flange x 3-1/4" M. Acme Fixed - w/ screen | 3.2 CC                  | Ductile/Brass | A                  | 12.3          |
| <b>ME808S-16</b>  | Low Emission Transfer Valve 4 Bolt Type B Flange x 3-1/4" M. Acme Fixed             | 3.2 CC                  | Ductile/Steel | A                  | 12.3          |
| <b>ME808SA-16</b> | Low Emission Transfer Valve 4 Bolt Type B Flange x 3-1/4" M. Acme Fixed - w/ screen | 3.2 CC                  | Ductile/Steel | A                  | 12.4          |
| Accessories       |   |                         |               |                    |               |
| Part No.          | Description   |                         |               |                    |               |
| ME807PIB          | MEC Smart Interlock Sensor Kit for ME807 Series                                     |                         |               |                    |               |





# TURBO-FLO LE™ TRANSFER SYSTEM

## LOW EMISSION ACME ADAPTERS

| Turbo-Flo LE™ Acme Adapters |                 |               |                          |                         |          |                                      |                                    |                         |
|-----------------------------|-----------------|---------------|--------------------------|-------------------------|----------|--------------------------------------|------------------------------------|-------------------------|
| Part No.                    | Inlet (M. Acme) | Outlet (MNPT) | Factory Installed Screen | Discharge at Disconnect | Material | Accessories                          |                                    |                         |
|                             |                 |               |                          |                         |          | Mechanical Brake Interlock Retro-Fit | Electronic Proximity Interlock Kit | Back Check Test Adapter |
| ME866-8                     | 1-3/4"          | 1"            | No                       | .16 CC                  | Brass    | —                                    | —                                  | —                       |
| ME866A-10                   | 1-3/4"          | 1-1/4"        | Yes                      | .16 CC                  | Brass    | —                                    | —                                  | —                       |
| ME867-10                    | 2-1/4"          | 1-1/4"        | No                       | 1.96 CC                 | Brass    | —                                    | —                                  | —                       |
| ME867A-10                   | 2-1/4"          | 1-1/4"        | Yes                      | 1.96 CC                 | Brass    | —                                    | —                                  | —                       |
| ME868-16*                   | 3-1/4"          | 2"            | No                       | 3.11 CC                 | Brass    | ME868MIB                             | ME868PIB                           | MEP105                  |
| ME868A-16*                  | 3-1/4"          | 2"            | Yes                      | 3.11 CC                 | Brass    | ME868MIB                             | ME868PIB                           | MEP105                  |
| ME868-24*                   | 3-1/4"          | 3"            | No                       | 3.11 CC                 | Brass    | ME868MIB                             | ME868PIB                           | MEP105                  |
| ME868A-24*                  | 3-1/4"          | 3"            | Yes                      | 3.11 CC                 | Brass    | ME868MIB                             | ME868PIB                           | MEP105                  |



**ME868-16**  
U.S. Patented  
Canada Patent Pending



\* Not for use in conjunction with soft seat back check

## ACCESSORIES

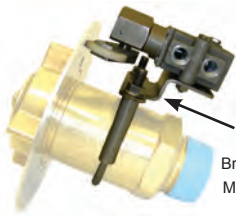

**ME868MIB**  
Bracket and clamp only  
ME868-16 & ME441F8  
not included



**ME868BLK**



**MEP105**



**ME868PIB**  
Patent Pending

ME868-16  
& ME441F8 not  
included

**ME868BLK** – “Bypass Line Kit” is used to create a one-way closed loop between the upstream and downstream sides of a Marshall Excelsior 2” globe valve when used in conjunction with a ME868 Series low emission Acme adapter. The kit features a brass one-way check valve and preformed heavy wall copper tubing with brazed end fittings for durability. This product is intended to prevent over pressurization of the ME868 Series low emission Acme adapters making them truly low emission. This product will also greatly reduce pressures within the ME868 Series adapters thereby decreasing any wear that may occur to the shutoff valves or the low emission Acme adapter.

**ME868MIB** – “Mechanical Interlock Bracket” allows for a standard Parker style pneumatic air roller valve normally used in conjunction with standard bobtail brake interlock systems to be retro-fit to the ME868 Series low emission Acme adapters. This bracket system allows the standard brake interlock system and connections to be moved forward to the end of the low emission adapter where normal contact with the ME441F8 flange Acme cap can occur. The kit includes all bracketing and mounting hardware. (Kit does not include Parker style pneumatic roller valve P/N CW9425)

**ME868PIB** – “Proximity Interlock Bracket” uses the new MEC smart interlock technology designed to connect with the Allison automatic transmission “auxiliary function range inhibit” preventing operation of the bobtail while this connection is in use. MEC smart interlock technology incorporates a high grade TURCK proximity switch that senses the presence of the stainless steel flange on the ME441F8 Acme cap when secured tightly to the ME868 Series low emission Acme adapter. This kit comes complete with all mounting hardware, MEC smart interlock technology and wiring harness to reach 5’ below the deck of the bobtail.

**MEP105** – This adapter allows for the periodic evacuation and testing of a bobtail’s internal back check valve during five year inspection requirements. The adapter fits snugly into the female Acme side of a ME130 which then can be threaded onto the ME868 Series low emission Acme adapter pushing the valve poppet to the open position thereby depressurizing the system for testing purposes. (Note: Be sure to consult instruction manual supplied with MEP105 test adapter before attempting use.)



# HIGH FLOW GLOBE & ANGLE VALVES

Marshall Excelsior offers three types of globe and angle valves (standard, integrated pilot feature (P) or integrated back check feature (IBC)) depending on the intended application. All Marshall Excelsior globe and angle valves are designed to withstand extreme temperatures and can **increase flow up to 70 percent** over a standard globe valve. The 35 degree seat angle on the 1-1/4" and larger globe valves make them ergonomically designed for bobtail, transport and bulk plant applications. This 35 degree seat angle also allows up to 70 percent more flow. The 1-1/4" and larger globe and angle valves have an optional 360 degree rotating ME829 **E-ZTurn** knob

To increase the longevity of the seal, all Marshall Excelsior globe and angle valves have a 360 degree rotating seal that stops rotating when it contacts the sealing surface while the valve continues to be tightened. The 1-1/4" and larger models feature ball bearings to facilitate increased seal life.

All 1-1/4" and larger globe and angle valves come with an upstream and downstream plugged port. The boss of these ports are large enough to drill and tap a 3/4" FNPT hole for a jumper line or standard by-pass valve.

These valves are mainly used in piping systems to control liquid or vapor flow in bulk plants, bobtails, transports, pumps or compressors. Globe valves are designed to be installed in a straight section of piping and angle valves are designed to be installed when a 90 degree directional change is needed in the piping.

Change the sealing compound and Marshall Excelsior's globe and angle valves can be used in numerous industries including, but not limited to LP-Gas, anhydrous ammonia, petrochemical and chemical applications. The standard seal compound is Nitrile with PTFE or FKM also available. Contact us if you have a need for a different seal compound.

Marshall Excelsior valves are designed to be hand tightened. Using wrenches or excess force to open or close the valve can cause damage to the seal, decreasing the valve's life.

**Installation Note:** Before installing a globe or angle valve, the piping system and container must be free of dirt, debris, foreign matter and other particles, large or small, that could damage the sealing surface or seal of the valve. A minimal amount of pipe sealant should be used on the mating part. Excess pipe sealant can also cause damage to the seal surface or seal. Damage to the sealing surface or the seal will cause the valve to leak.

To avoid damage to the valve or piping, due to pressure build-up from temperature changes, a hydrostatic relief valve should be installed where liquid can be trapped between two shutoff valves.

A vent valve should be installed on the downstream side of the globe or angle valve if the angle valve is used as a shutoff valve at the end of a loading hose. This allows the operator to vent the trapped liquid before disconnect.

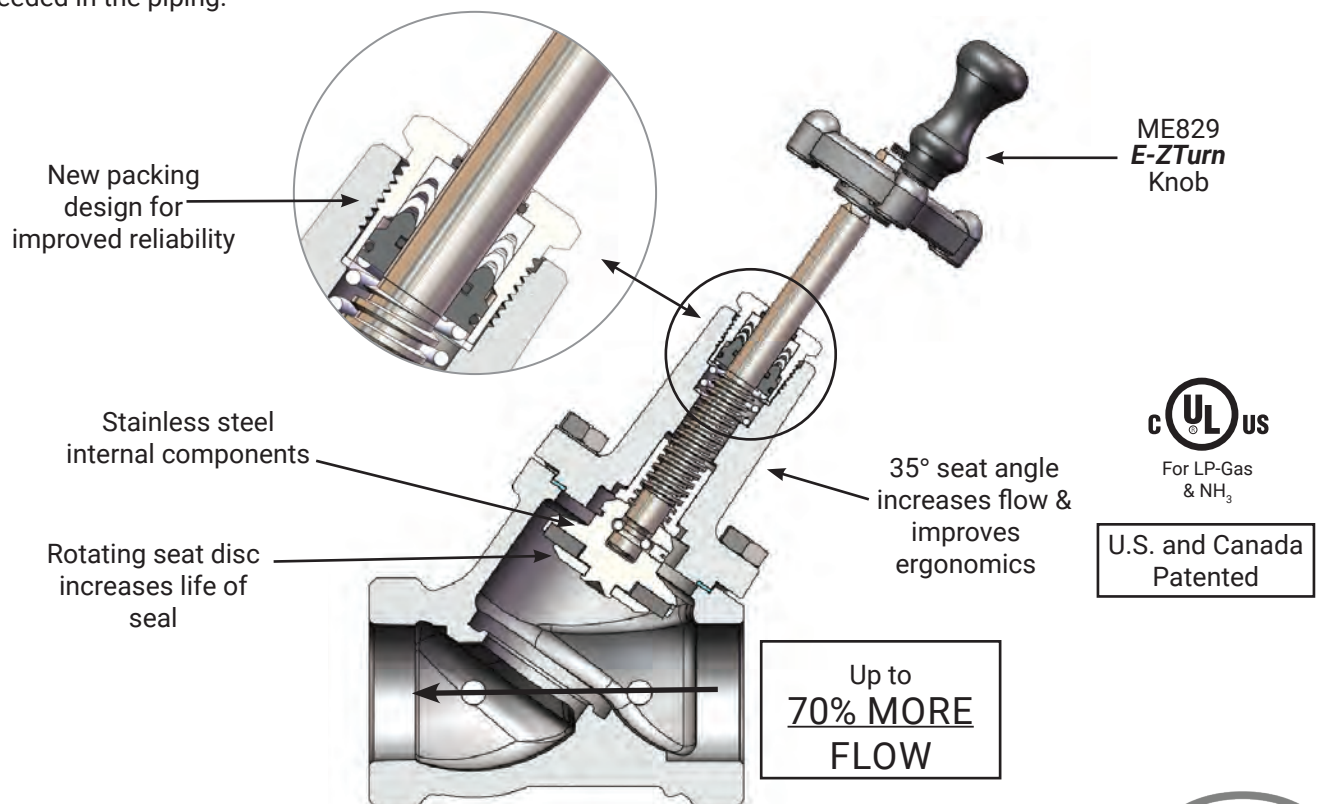

# HIGH FLOW GLOBE & ANGLE VALVES

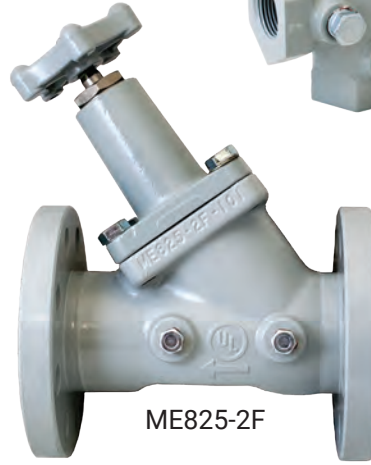

MEP449S-101  
Replacement Protective  
Weather Boot

## FEATURES

- All stainless steel internal components with rotating seat disc design & V-cup PTFE packing stem seals
- Double stem seal design ensures leak free operation
- Double lead stem thread ensures quick and efficient operation
- Durable ductile iron valve body with automotive grade powder coat finish
- 1-1/4" & larger globe valves have 35° seat angle for maximum product flow
- 1-1/4" & larger globe valve designed ergonomically correct for bobtail transport and bulk plant applications
- 1-3/4", 2-1/4" & 3-1/4" Acme threads available on globe valves
- Rated for 400 WOG
- Operating temperature -40° to +212° Fahrenheit

| Part No. |          | Inlet (FNPT)     | Outlet           | Side Port (FNPT) | No. of Side Ports | Flange Style Bonnet | Accessories   |                                    |                                 |                               |
|----------|----------|------------------|------------------|------------------|-------------------|---------------------|---------------|------------------------------------|---------------------------------|-------------------------------|
| Angle    | Globe    |                  |                  |                  |                   |                     | E-Z Turn Knob | Push-To-Turn Locking Handwheel Kit | Hydrostatic Relief Valves       | Vent Valves                   |
| ME815-4  | ME825-4  | 1/2"             | 1/2" FNPT        | 1/4"             | 2                 | No                  | —             | —                                  |                                 |                               |
| ME815-6  | ME825-6  | 3/4"             | 3/4" FNPT        | 1/4"             | 2                 | No                  | —             | —                                  |                                 |                               |
| ME815-8  | ME825-8  | 1"               | 1" FNPT          | 1/4"             | 2                 | No                  | —             | —                                  | MEH225<br>MEH225SS<br>MEH25/450 | MEJ400<br>MEJ400SC<br>MEJ402S |
| ME815-10 | ME825-10 | 1-1/4"           | 1-1/4" FNPT      | 1/4"             | 2                 | Yes                 | ME829         | ME815-16LHK                        |                                 |                               |
| ME815-12 | ME825-12 | 1-1/2"           | 1-1/2" FNPT      | 1/4"             | 2                 | Yes                 | ME829         | ME815-16LHK                        |                                 |                               |
| ME815-16 | ME825-16 | 2"               | 2" FNPT          | 1/4"             | 2                 | Yes                 | ME829         | ME815-16LHK                        |                                 |                               |
| —        | ME824-16 | 2"               | 2" FNPT          | 1/2"             | 2                 | Yes                 | ME829         | ME815-16LHK                        | MEH50/460                       | —                             |
| ME815-2F | ME825-2F | 2"-300LB Flanged | 2"-300LB Flanged | 1/4"             | 2                 | Yes                 | ME829         | ME815-16LHK                        | MEH225<br>MEH225SS<br>MEH25/450 | MEJ400<br>MEJ400SC<br>MEJ402S |
| ME815-24 | ME825-24 | 3"               | 3" FNPT          | 1/4"             | 2                 | Yes                 | included      | —                                  |                                 |                               |
| ME815-3F |          | 3"-300LB Flanged | 3"-300LB Flanged | 1/4"             | 2                 | Yes                 | included      | —                                  |                                 |                               |

To order FKM seal add "V" after the prefix part number. For PTFE Seal add "T" after the prefix part number i.e. ME815T-10 or ME815V-10



# EXCELA-FLANGE™ HIGH FLOW GLOBE & ANGLE VALVES

The ME813, ME818, ME819 and ME823 Series valves feature our new modular **Excelsa-Flange™** 4 Bolt inlet/outlet design that can be easily adapted to both NPT thread or socket weld type A companion flanges (ME840 & ME841 Series) ranging from 1-1/4" to 2" in diameter making it universal to piping sizes within this range. This innovative system allows installers the ability to eliminate unnecessary connections as well as possible leak points by integrating a convenient 4 bolt flange union at the valve inlet/outlet connections.

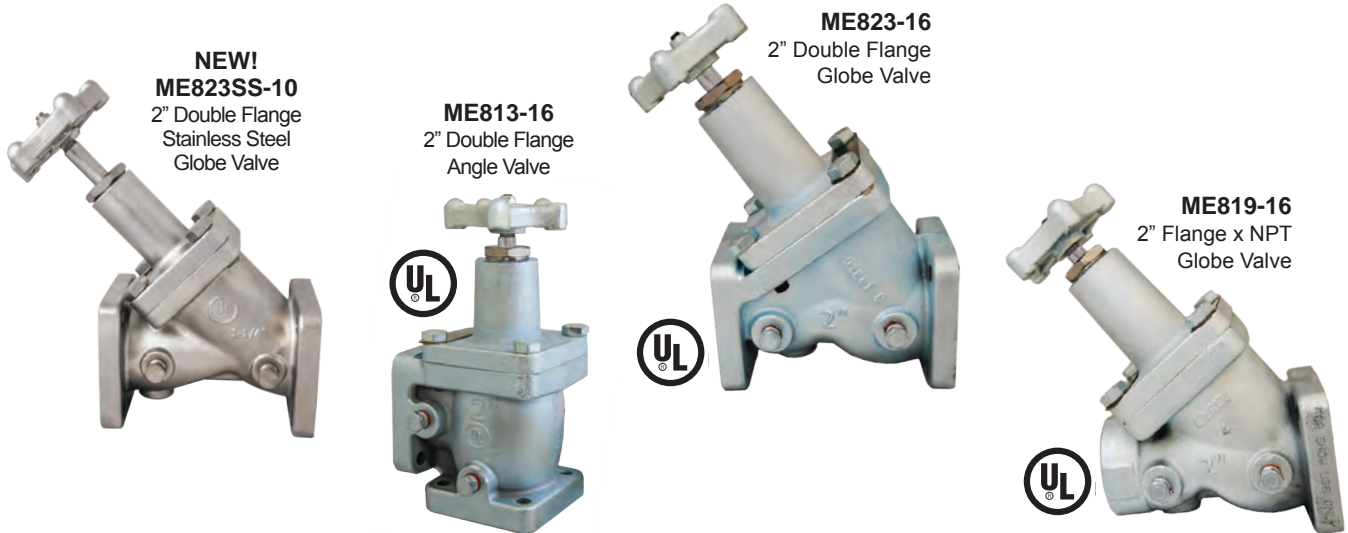

## FEATURES

- All stainless steel internal components with rotating seat disc design & V-cup PTFE packing stem seals
- Durable ductile iron valve body with zinc plating finish
- 1-1/4" & larger globe valves have 35° seat angle for maximum product flow
- 1-1/4" & larger globe valve designed ergonomically correct for bobtail transport and bulk plant applications
- Rated for 400 WOG
- Operating temperature -40° to +212° Fahrenheit
- Up to **70% MORE FLOW** than the nearest competitor
- 1/4" FNPT or 1/2" FNPT plugged accessory ports upstream and downstream of valve seat
- Standard Nitrile seat, optional PTFE or FKM seat
- **Some models available with CF8M Stainless Steel body & bonnet**

| Angle                     | Globe                          | Description                                   | Side Ports (FNPT) | Inlet                | Outlet               | Mating Flange Type | Weight (lbs.) |       |
|---------------------------|--------------------------------|---|-------------------|----------------------|----------------------|--------------------|---------------|-------|
|                           |                                |   |                   |                      |                      |                    | Angle         | Globe |
| ME813-10                  | ME823-10                       | 1-1/4" - 4 Bolt Full Flow Double Flange Valve | 1/4"              | 4 Bolt Flange Type B | 4 Bolt Flange Type B | A                  | 14.8          | 15.3  |
| -                         | ME823SS-10 <sup>(1)</sup>      |   | 1/4"              |                      |                      | A                  | -             | 15.0  |
| -                         | ME822-16                       |   | 1/2"              |                      |                      | A                  | -             | 19.7  |
| ME813-16                  | ME823-16                       | 1/4"  | A                 |                      |                      | 17.6               | 19.6          |       |
| ME813SS-16 <sup>(1)</sup> | ME823SS-16-4 <sup>(1)(2)</sup> | 1/4"  | A                 |                      |                      | 16.0               | 17.0          |       |
| -                         | ME818-16                       | 1/2"  | A                 |                      | -                    | 17.7               |               |       |
| -                         | ME819-10                       | 1-1/4" - 4 Bolt Full Flow Single Flange Valve | 1/4"              |                      | 2" FNPT              | A                  | -             | 17.7  |
| -                         | ME819SS-10 <sup>(1)</sup>      |   | 1/4"              |                      | 1-1/4" FNPT          | A                  | -             | 13.5  |
| -                         | ME819-16<br>ME819-16-4         |   | 1/4"              |                      | 2" FNPT              | A                  | -             | 17.7  |
| -                         | ME819SS-16-4 <sup>(1)(2)</sup> | 1/4"  | 1/4"              |                      | 2" FNPT              | A                  | -             | 15.5  |

(1) "SS" indicates CF8M Stainless Steel body & bonnet

(2) ME823SS-16-4 and ME819SS-16-4 include a bottom port

# EXCELA-FLANGE™ HIGH FLOW GLOBE & ANGLE VALVES

## NEXT GENERATION

The Next Generation Flanged 2" Globe and Angle Valves feature our new modular **Excelsa-Flange™** 4 Bolt inlet/outlet design that can be easily adapted to both NTP thread or socket weld type A companion flanges (ME840 & ME841 Series) ranging from 1-1/4" to 2" in diameter making it universal to piping sizes within this range. This innovative system allows installers the ability to eliminate unnecessary connections as well as possible leak points by integrating a convenient 4 bolt flange union at the valve inlet/outlet connections.

- ALL OF THE SAME GREAT FEATURES OF THE ORIGINAL FULL FLOW MEC GLOBE VALVES WITH ADDITIONAL PRODUCT PERFORMANCE ENHANCEMENTS.

**Pilot Feature: (P)** This globe valve model incorporates a pilot orifice feature to facilitate pressure equalization in sections of system piping that have bidirectional flow or high differential pressures. This greatly reduces the opening torque required and prevents premature wear of the valve seat.

**Integrated Back Check Feature: (IBC)** These globe and angle valve models incorporate an integrated backcheck feature to allow trapped downstream pressure to automatically bypass to the upstream side of the valve. These valves are designed for systems with flow in one direction, creating a closed loop system that prevents the product from relieving to the atmosphere making for a low emission, more environmentally friendly option.

**PATENT  
#8,596,301**

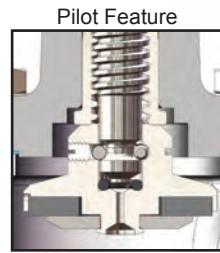
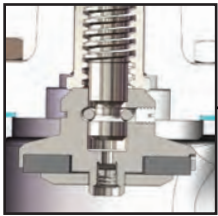
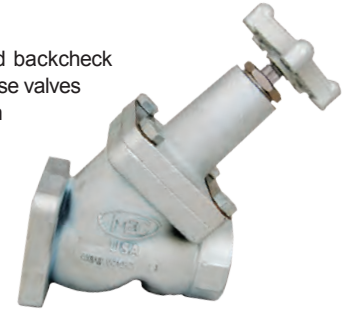

Up to  
**70% MORE  
FLOW**

**ME823IBC-16**



**ME823P-16**



| Angle             | Globe                   | Description                                   | Side Ports (FNPT) | Inlet                | Outlet               | Mating Flange Type   | Weight (lbs.) |       |      |      |
|-------------------|-------------------------|---|-------------------|----------------------|----------------------|----------------------|---------------|-------|------|------|
|                   |                         |   |                   |                      |                      |                      | Angle         | Globe |      |      |
| ME813IBC-16       | ME823IBC-16             | 2" Full Flow 4 Bolt Double Flange (IBC) Valve | 1/4"              | 4 Bolt Flange Type B | 4 Bolt Flange Type B | A                    | 17.6          | 20.1  |      |      |
| ME813SSIBC-16 (1) | ME823SSIBC-16-4 (1) (2) |   | 1/4"              |                      |                      | A                    | 15.5          | 17.0  |      |      |
| —                 | ME822IBC-16             |   | 1/2"              |                      |                      | A                    | —             | 19.7  |      |      |
| ME813P-16         | ME823P-16               | 2" Full Flow 4 Bolt Double Flange (P) Valve   | 1/4"              |                      |                      | 4 Bolt Flange Type B | 2" FNPT       | A     | 18.1 | 20.1 |
| —                 | ME822P-16               |   | 1/2"              |                      |                      |                      |               | A     | —    | 20.1 |
| —                 | ME818IBC-16             | 2" Full Flow 4 Bolt Single Flange (IBC) Valve | 1/2"              |                      |                      |                      |               | A     | —    | 18.2 |
| —                 | ME818P-16               | 2" Full Flow 4 Bolt Single Flange (P) Valve   | 1/2"              |                      |                      |                      |               | A     | —    | 18.2 |
| —                 | ME819IBC-16             | 2" Full Flow 4 Bolt Single Flange (IBC) Valve | 1/4"              |                      |                      |                      |               | A     | —    | 18.1 |
| —                 | ME819IBC-16-4           |   | 1/4"              |                      |                      |                      |               | A     | —    | 18.1 |
| —                 | ME819SSIBC-16-4 (1)     |   | 1/4"              | A                    | —                    |                      |               | 15.5  |      |      |
| —                 | ME819P-16               | 2" Full Flow 4 Bolt Single Flange (P) Valve   | 1/4"              | A                    | —                    |                      |               | 18.1  |      |      |

(1) "SS" indicates CF8M Stainless Steel body & bonnet

(2) ME823SSIBC-16-4 includes a 1/2" FNPT bottom port

# HIGH FLOW GLOBE & ANGLE VALVES

## NEXT GENERATION

These **Next Generation High Flow Globe and Angle Valves** have the same great features of the original High Flow MEC globe and angle valves with additional product performance enhancements. These globe and angle valves provide a positive shutoff that is highly reliable with High Flow performance with bidirectional flow or reduced product emissions.

**Integrated Back Check Feature (IBC)** - Designed for use in sections of piping where the trapped liquid pressure may exceed 100 psig between two valves. When trapped liquid pressure exceeds 100 psig, the integrated back check feature automatically bypasses trapped downstream system pressure through the valve seat to the upstream side of the valve into the product container or piping. A closed looped system is created because the 100 psig is far below the 400–500 psig set pressure of a hydrostatic relief valve keeping the product in the system and reducing product emissions.

**WARNING:** NFPA 58 requires that a hydrostatic relief valve be installed into any section of piping that could allow liquid to become trapped between two shutoff valves.

**Integrated Pilot Feature (P)** - Designed for sections of piping that have bidirectional flow. Standard globe and angle valves installed in bidirectional systems can have a potential for back pressure to build-up on the upstream side of a closed valve. This pressure adds to the force required to open the valve causing additional wear to the valve stem and seat material. The integrated pilot feature allows the first portion of stem travel to unseat the pilot orifice, automatically equalizing the system pressure prior to unseating the valve holder seal. This greatly reduces the opening torque required in bidirectional systems and prevents premature wear of the primary valve seat material and valve components.

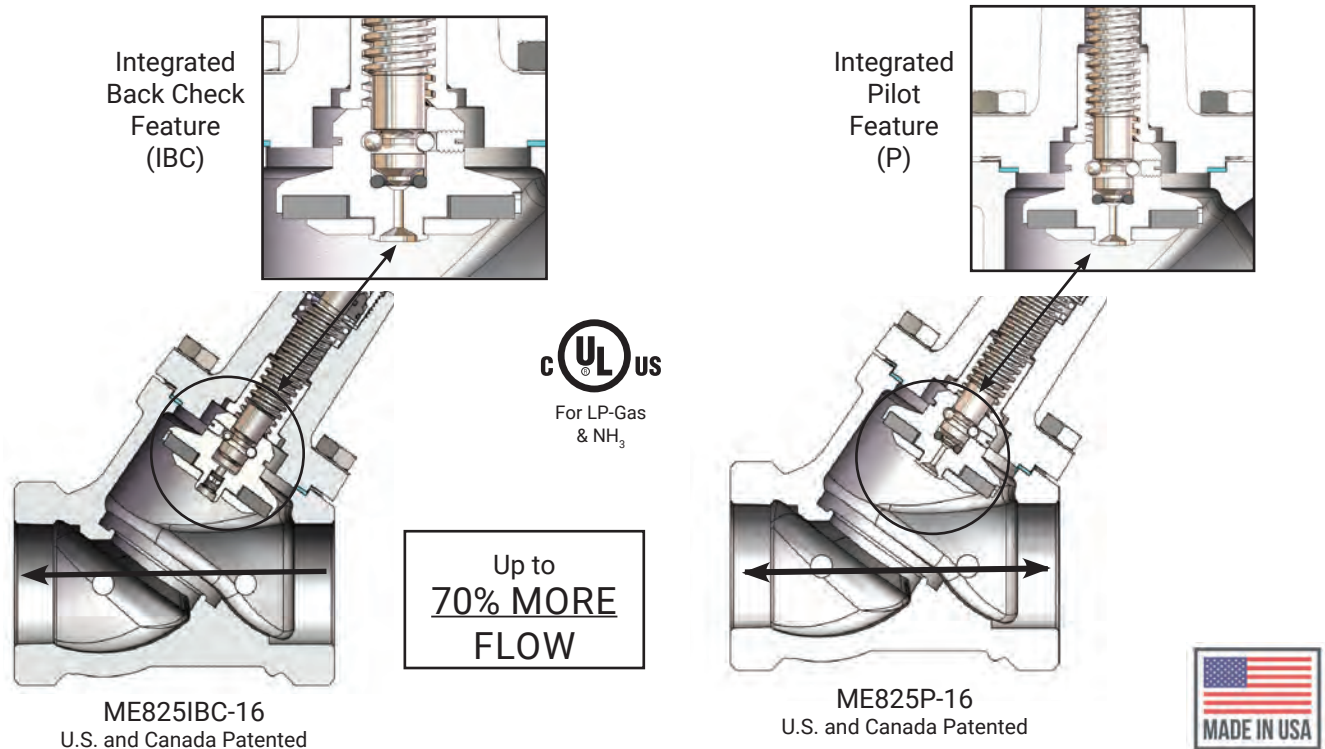

| Part No.              |               |                       |               | Inlet (FNPT) | Outlet  | Side Port (FNPT) | No. of Side Ports | Flange Style Bonnet | Accessories   |                                |                               |
|-----------------------|---------------|-----------------------|---------------|--------------|---------|------------------|-------------------|---------------------|---------------|--------------------------------|-------------------------------|
| Angle                 |               | Globe                 |               |              |         |                  |                   |                     | E-Z Turn Knob | Hydrostatic Relief Valves      | Vent Valves                   |
| Integrated Back Check | Pilot Feature | Integrated Back Check | Pilot Feature |              |         |                  |                   |                     |               |                                |                               |
| ME815IBC-16           | ME815P-16     | ME825IBC-16           | ME825P-16     | 2"           | 2" FNPT | 1/4"             | 2                 | Yes                 | ME829         | MEH225<br>MEH225S<br>MEH25/450 | MEJ400<br>MEJ400SC<br>MEJ402S |
| —                     | —             | ME824IBC-16           | ME824P-16     | 2"           | 2" FNPT | 1/2"             | 2                 | Yes                 | ME829         | MEH50/460                      | —                             |



# EXCELA-FLANGE™ HIGH FLOW GLOBE VALVES

## 2" INTEGRATED PILOT VALVES W/ BOTTOM PORT

Provides a positive shut-off valve that is highly reliable with full flow performance while providing bi-directional flow. Ideally suited for use on transport trailers with 1/2" blow down lines to provide rapid and complete product evacuation prior to disconnecting transfer hose. Valves can be purchased with hydrostatic relief valves pre-installed on the out board side port of the globe valve main seal.

- All of the same great features of the original full flow MEC globe valves with additional product performance enhancements.

**Pilot Feature: (P)** This globe valve model incorporates a pilot orifice feature to facilitate pressure equalization in sections of system piping that have bidirectional flow or high differential pressures. This greatly reduces the opening torque required and prevents premature wear of the valve seat.

The **Excelsa-Flange™** 2" bottom port operated flanged globe valves feature our new modular Excelsa-Flange 4 bolt inlet/outlet flange design that can be easily adapted to both NPT thread or socket weld Type A companion flanges (ME840 & ME841 Series) ranging from 1-1/4" to 2" in diameter making it universal to piping sizes within this range. This innovative system allows installers the ability to eliminate unnecessary connections as well as possible leak points by integrating a convenient 4 bolt flange union at the valve inlet/outlet connections.

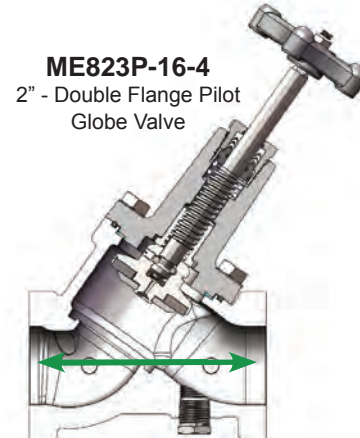
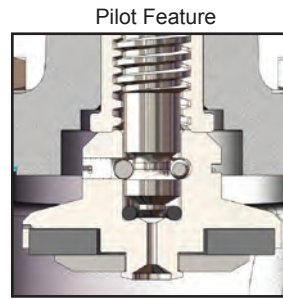
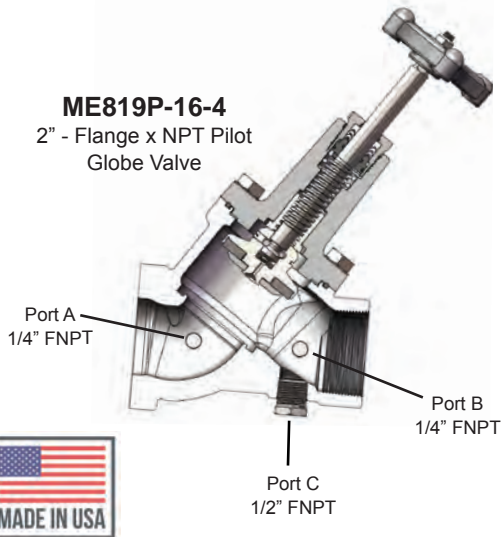

Up to  
**70% MORE**  
FLOW



| Part No                                | Description                                   | 1/4" FNPT<br>Side Port A | 1/4" FNPT<br>Side Port B | 1/2" FNPT<br>Bottom<br>Port C | Inlet                      | Outlet                     | Mating<br>Flange<br>Type | Weight<br>(lbs) |
|--|---|--------------------------|--------------------------|-------------------------------|----------------------------|----------------------------|--------------------------|-----------------|
| <b>ME822P-16-4</b> <sup>(1)</sup>      | 2" Full Flow<br>4 Bolt<br>Flange (P)<br>Valve | Plugged                  | Plugged                  | Plugged                       | 4 Bolt<br>Flange<br>Type B | 4 Bolt<br>Flange<br>Type B | A                        | 20.2            |
| <b>ME822SSP-16-4</b> <sup>(1)(2)</sup> |   | Plugged                  | Plugged                  | Plugged                       |                            |                            | A                        | 17.0            |
| <b>ME823P-16-4</b>                     |   | Plugged                  | Plugged                  | Plugged                       |                            |                            | A                        | 20.1            |
| <b>ME823SSP-16-4</b> <sup>(2)</sup>    |   | Plugged                  | Plugged                  | Plugged                       |                            |                            | A                        | 17.0            |
| <b>ME823P-16H-4</b>                    |   | Plugged                  | MEH225                   | Plugged                       |                            |                            | A                        | 20.1            |
| <b>ME823P-16HSS-4</b>                  |   | Plugged                  | MEH225SS                 | Plugged                       |                            |                            | A                        | 20.1            |
| <b>ME823SSP-16HSS-4</b> <sup>(2)</sup> |   | Plugged                  | MEH225SS                 | Plugged                       |                            | A                          | 17.0                     |                 |
| <b>ME818P-16-4</b> <sup>(1)</sup>      |   | Plugged                  | Plugged                  | Plugged                       |                            | 2" FNPT                    | A                        | 18.2            |
| <b>ME819P-16-4</b>                     |   | Plugged                  | Plugged                  | Plugged                       |                            |                            | A                        | 18.2            |
| <b>ME819SSP-16-4</b> <sup>(2)</sup>    |   | Plugged                  | Plugged                  | Plugged                       |                            |                            | A                        | 15.5            |
| <b>ME819P-16H-4</b>                    |   | Plugged                  | MEH225                   | Plugged                       |                            |                            | A                        | 18.2            |
| <b>ME819P-16HSS-4</b>                  |   | Plugged                  | MEH225SS                 | Plugged                       |                            |                            | A                        | 18.2            |
| <b>ME819SSP-16HSS-4</b> <sup>(2)</sup> |   | Plugged                  | MEH225SS                 | Plugged                       |                            |                            | A                        | 15.5            |

(1) Indicates all ports 1/2" FNPT

(2) "SS" indicates CF8M Stainless Steel body & bonnet

# HIGH FLOW GLOBE VALVES

## 2" NEXT GENERATION - 1/2" BOTTOM PORT

Provides a positive shut-off valve that is highly reliable with high flow performance while providing bi-directional flow. Ideally suited for use on transport trailers with 1/2" blow down lines to provide rapid and complete product evacuation prior to disconnecting the transfer hose. Valves can be purchased with hydrostatic relief valves pre-installed in the side port of the globe valve downstream of the main seal.

- All of the same great features of the original full flow MEC globe valves with additional product performance enhancements.
- **Pilot Feature: (P)** These globe valve models incorporate a pilot orifice feature to facilitate pressure equalization in sections of system piping that have bidirectional flow or high differential pressures. This greatly reduces the opening torque required and prevents premature wear of the valve seat.

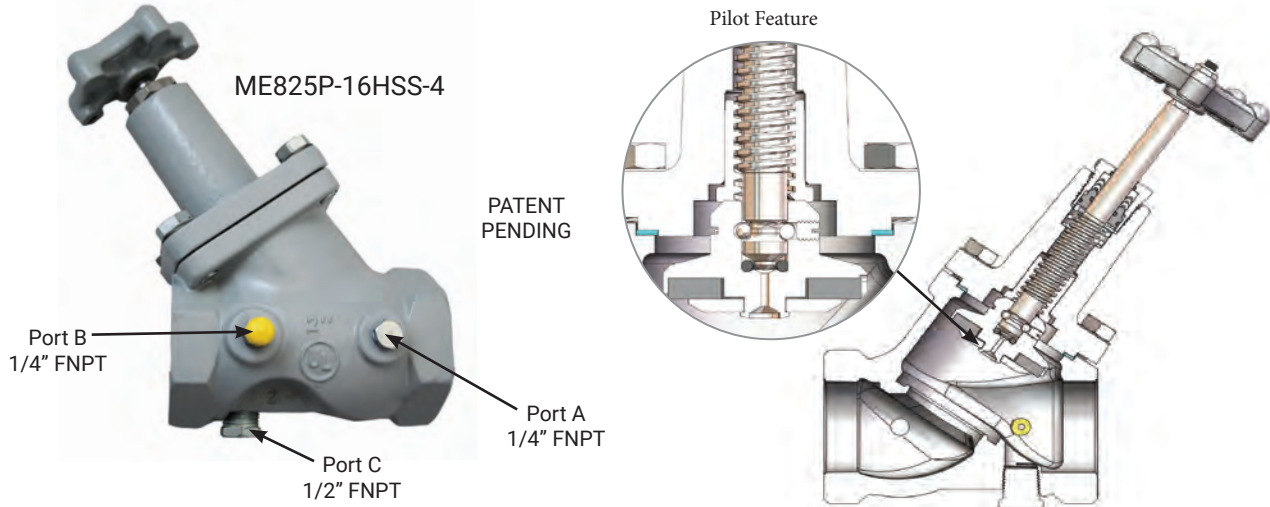

| Next Generation Globe and Angle Valves |   |                       |                       |                       |              |               |
|--|---|-----------------------|-----------------------|-----------------------|--------------|---------------|
| Part No.                               | Description                                   | 1/4" FNPT Side Port A | 1/4" FNPT Side Port B | 1/2" FNPT Bottom Port | Inlet/Outlet | Accessories   |
|  |   |                       |                       |                       |              | E-Z Turn Knob |
| ME825P-16-4                            | Full Flow Valve with Integrated Pilot Feature | Plugged               | Plugged               | Plugged               | 2" FNPT      | ME829         |
| ME825P-16H-4                           | Full Flow Valve with Integrated Pilot Feature | Plugged               | MEH225                | Plugged               | 2" FNPT      | ME829         |
| ME825P-16HSS-4                         | Full Flow Valve with Integrated Pilot Feature | Plugged               | MEH225SS              | Plugged               | 2" FNPT      | ME829         |

## PUSH-TO-TURN LOCKING HANDWHEEL KIT

Helps prevent accidental opening of any 1-1/4", 1-1/2", or 2" MEC angle or globe valve configuration. Once installed the kit requires the operator to push down on the hand wheel to engage the valve stem in order to open or fully close the valve making it a deliberate action to actuate. The ejection spring disengages the handwheel from the stem when released, preventing unintentional opening of the valve.

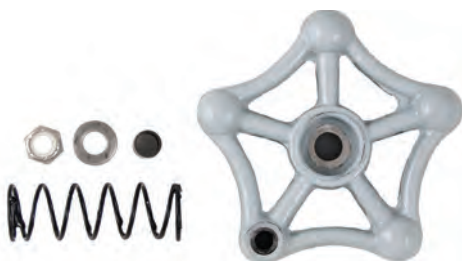

| Part No.    | Description   |
|-------------|---|
| ME815-16LHK | Push-To-Turn Locking Handwheel Kit for all 1-1/4", 1-1/2" & 2" MEC Angle / Globe Valves |

Note: MEC strongly recommends use of ME829 EZ-Turn Handwheel knob to promote ease of use for this product (NOT INCLUDED IN ME815-16LHK KIT).



# FLANGED FULL PORT GLOBE VALVES

The **Full Port Flanged Globe Valves** provide all the servicability features of a traditional globe valve with the full port flow capacity of a ball valve. Flanged end connections facilitate easy servicing along with a replaceable valve seat providing long service life for your investment. The valve also features an integrated pilot feature allowing pressure equalizing across the valve seat for bi-directional system flow.

**WARNING** – Downstream Pressure Differential Should NOT Exceed 50PSI For Proper Seal Function & Piping Isolation

## FEATURES

- Has same great reliable and durable teflon stem packing glands as our other globe valves
- Features exclusive slip cam construction for full port flow rates
- All stainless steel internal component construction for maximum corrosion resistance
- Removable bonded main seat disc assembly
- Same overall length as ANSI ball valve
- **Pilot Feature: (P)** These globe valve models incorporate a pilot orifice feature to facilitate pressure equalization in sections of system piping that have bidirectional flow or high differential pressures. This greatly reduces the opening torque required and prevents premature wear of the valve seat.

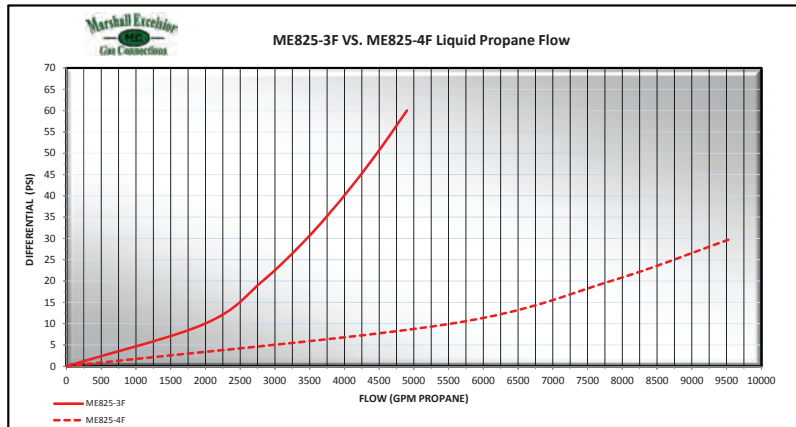
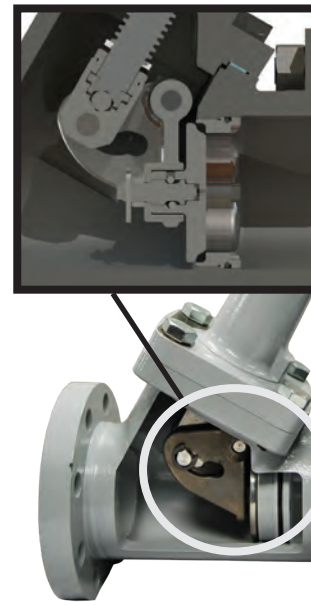

| Part No.        | Description   | Side Port (FNPT) | No. of Side Ports | Inlet     | Outlet    |
|-----------------|---|------------------|-------------------|-----------|-----------|
| <b>ME825-3F</b> | Full Port Globe Valve with Integrated Pilot Feature | 1/4"             | 2                 | 3"-300 LB | 3"-300 LB |
| <b>ME825-4F</b> | Full Port Globe Valve with Integrated Pilot Feature | 1/4"             | 2                 | 4"-300 LB | 4"-300 LB |
| Accessories     |   |                  |                   |           |           |
| Part No.        | Description   |                  |                   |           |           |
| ME829           | Black Handwheel E-Z Turn Knob Kit                   |                  |                   |           |           |
| ME980SK-24      | 3" & 4"-300LB ESV & Globe Valve Flange Stud Kit     |                  |                   |           |           |
| ME904S-3F-027   | 3"-300 LB Spiral Ring Flange Gasket-Carbon Steel    |                  |                   |           |           |
| ME904S-4F-027   | 4"-300 LB Spiral Ring Flange Gasket-Carbon Steel    |                  |                   |           |           |



# EXCELA-FLANGE™ SERIES

## HIGH FLOW SOCKET WELD BODIES

These tees and elbows are available in both 2" and 3" socket weld or butt weld pipe configuration and maximize flow through system piping where a 90° turn must be made. Flow rates are maximized by an optimized flow path as well as nearly seamless piping joints reducing turbulence and focusing flow through the system. Ideally suited for pump discharge lines, transport loading/unloading tee assemblies, spray fill lines or any other piping application where piping is welded and high flow rates are desired.



**MEP996S-16**  
2" F. Socket Weld X  
2" F. Socket Weld Tee



**MEP995S-24/16**  
3" F. Socket Weld X  
(2") -2" F. Socket Weld Tee



**MEP995SBW-16**  
2" F. Butt Weld X (2") -2" F. Butt Weld Tee



**MEP999SBW-16**  
2" x 2" Butt Weld Elbow

### FEATURES

- All steel construction for maximum durability and weldability
- Available in 2" & 3" Socket Weld configurations
- 2" butt weld connection for shorter overall profiles and increase flexibility
- MEP999 Series features an integrated type A 4 bolt flange union
- Coated for maximum corrosion resistance
- Approved for use in LPG or NH<sub>3</sub> service
- Rated 400 WOG
- Available in Stainless Steel construction

### MEP995SBW-16 vs. Standard Tee

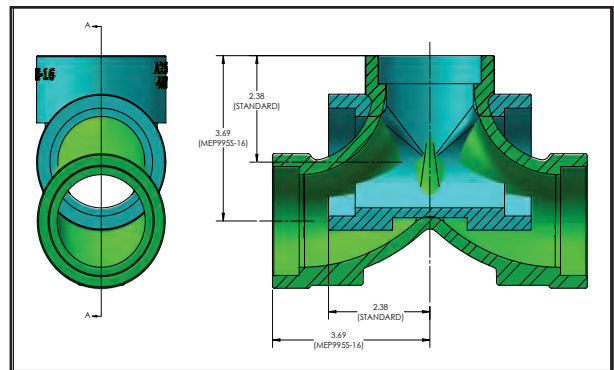

### FLOW COMPARISON 2 PSI DIFFERENTIAL - LIQUID PROPANE

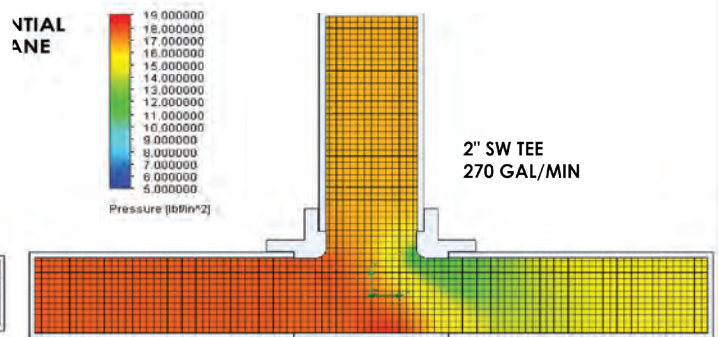
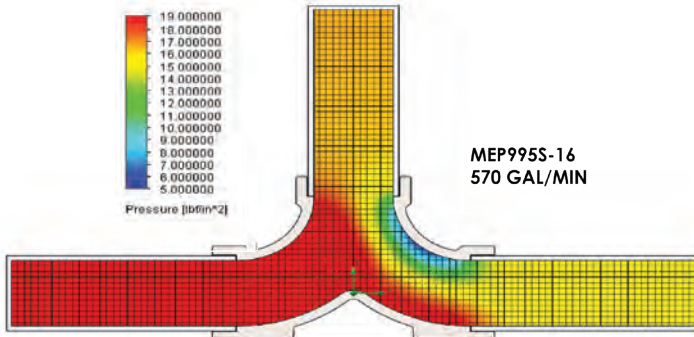

| MEC <i>Excela-Flange</i> ™ High Flow Socket Weld Tees   |                       |   |               |
|---|-----------------------|---|---------------|
| Part No.  |                       | Description   | Weight (lbs.) |
| WCC A216 Steel  | CF8M Stainless Steel  |   |               |
| <b>MEP995S-16</b>                                       | <b>MEP995SS-16</b>    | 2"x 2"x 2" Socket Weld High Flow Tee Body             | 6.1           |
| <b>MEP995S-24/16</b>                                    | <b>MEP995SS-24/16</b> | 3"x 2"x 2" Socket Weld High Flow Tee Body             | 7.8           |
| <b>MEP995SBW-16</b>                                     | <b>MEP995SSBW-16</b>  | 2"x 2"x 2" Butt Weld High Flow Tee Body               | 4.2           |
| <b>MEP999S-16</b>                                       | <b>MEP999SS-16</b>    | 4 Bolt Type A x 2"x 2" Socket Weld High Flow Tee Body | 7.0           |
| <b>MEP999SBW-16</b>                                     | <b>MEP999SSBW-16</b>  | 4 Bolt Type A x 2"x 2" Butt Weld High Flow Tee Body   | 5.72          |
| MEC <i>Excela-Flange</i> ™ High Flow Socket Weld Elbows |                       |   |               |
| Part No.  |                       | Description   | Weight (lbs.) |
| WCC A216 Steel  | CF8M Stainless Steel  |   |               |
| <b>MEP996S-16</b>                                       | <b>MEP996SS-16</b>    | 2" x 2" Socket Weld High Flow Elbow Body-Steel        | 3.8           |
| <b>MEP996SBW-16</b>                                     | <b>MEP996SSBW-16</b>  | 2" x 2" Butt Weld High Flow Elbow Body-Steel          | 2.5           |
| <b>MEP996S-24</b>                                       | <b>MEP996SS-24</b>    | 3" x 3" Socket Weld High Flow Elbow Body-Steel        | 6.7           |



# EXCELA-FLANGE™ SERIES

## 3" x 2" x 2" x 4-BOLT FLANGE HIGH FLOW CROSS-OVER SELF LOADING INTAKE ADAPTER

Specifically designed to allow for high flow liquid transfer in auxiliary self load cross-over line applications on mobile transport trailers. The MEP997S-24/16 is equipped with a 3" socket weld connection, to allow direct connection to ME994S-3F Series Excelsa-Flange Internal Valves and (2) 2" socket weld discharge ports as well as an auxiliary 4 bolt (type B) intake flange. The 4 bolt (type B) intake flange allows for maximum product flow, while providing a convenient flange union for system maintenance.



**MEP997-24/16**

3" Socket Weld X (2) 2" Socket Weld X 2"-4 Bolt  
(Type B) Flange Adapter

### FEATURES

- All steel (WCC A216) or stainless steel (CF8M) construction for maximum durability.
- Approved for use in LPG or NH<sub>3</sub> service
- Rated 400 WOG
- For use with all Type A (ME840 / ME841 Series) companion flanges

| Part No.       |                      | Description  | Flange Type | Weight (lbs.) |
|----------------|----------------------|--|-------------|---------------|
| WCC A216 Steel | CF8M Stainless Steel |  |             |               |
| MEP997S-24/16  | MEP997SS-24/16       | 3" Socket Weld x (2) 2" Socket Weld x 4 Bolt Flange Intake Adapter | B           | 10.0          |

## 2"- 4-BOLT FLANGE HIGH FLOW EXTENDED AUXILIARY PUMP DISCHARGE TEE ADAPTER

Designed to allow for high flow liquid transfer from the pump auxiliary discharge on mobile transport applications. The MEP999SPE-16 Series is available in WCC A216 Steel or CF8M Stainless steel construction and features a high flow tee design with 2" - 4 bolt type "A" (O-ring Groove) *Excelsa-Flange™* inlet/outlet connections.

### FEATURES

- All steel (WCC A216) or stainless steel (CF8M) construction for maximum durability.
- Approved for use in LPG or NH<sub>3</sub> service
- Rated 400 WOG
- For use with all Type B (ME842 / ME843 Series) companion flanges

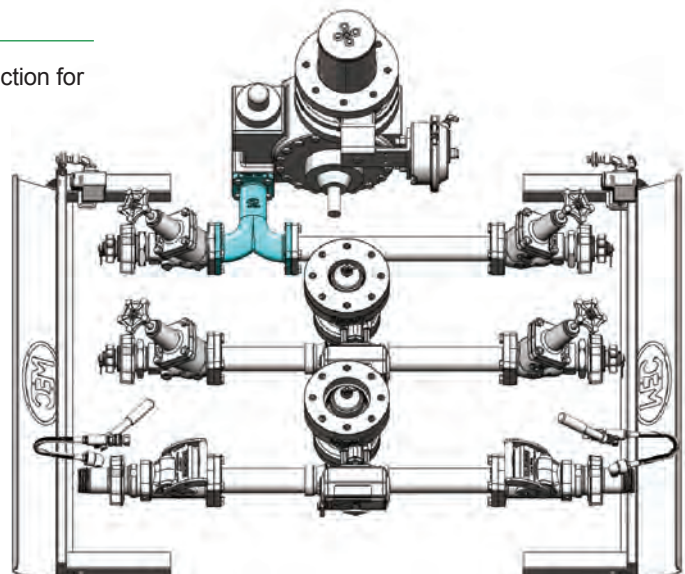

**MEP999SPE-16**

| Part No.      | Description   | Material             | Flange Type | Weight (lbs.) |
|---------------|---|----------------------|-------------|---------------|
| MEP999SPE-16  | <i>Excelsa-Flange™</i> 2" -4 Bolt (3)<br>Extended Tee Adapter | WCC A216 Steel       | A           | 12.1          |
| MEP999SSPE-16 |   | CF8M Stainless Steel | A           | 12.8          |



# 4 BOLT UNIONS & COMPANION FLANGES

These 4 bolt unions can be used anywhere system piping needs to be joined together between shut off valves. Using piping unions such as these significantly improves the ease by which maintenance can be performed particularly where long runs or multiple directional changes are necessary. Our flange unions feature a captured o-ring design, hardened mounting bolts, and are available in NTP or Socket Weld configurations. Suitable for use in mobile or stationary applications.

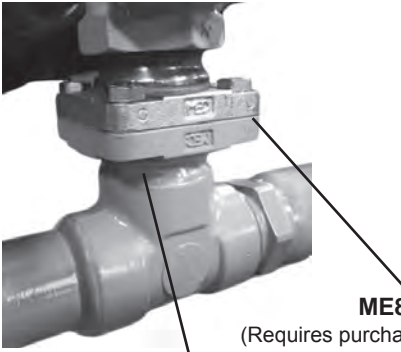

## FEATURES

- All steel or stainless steel construction for maximum durability and weldability
- Available in 1-1/4" - 2" FNPT or Socket Weld configurations
- Zinc plated flange faces for maximum corrosion resistance
- No plating on weld surfaces for improved weld quality with minimum weld prep
- Approved for use in LPG or NH<sub>3</sub> service
- Rated 400 WOG

**ME843-16-107**  
(Requires purchase of mating kit)  
**TYPE B FLANGE**

**ME841-16F**  
(Requires purchase of flat face flange)  
**TYPE A FLANGE**



**MEP840/MEP841**

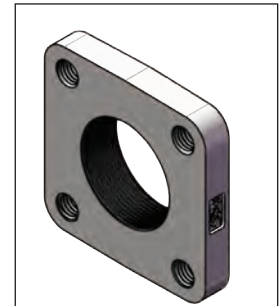

**TYPE "B"**

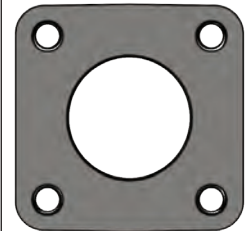

**FLAT FACE**

| MEC Flat Face Flanges |                      |  |             |               |
|-----------------------|----------------------|--|-------------|---------------|
| Part No.              |                      | Description  | Flange Type | Weight (lbs.) |
| WCC A216 Steel        | CF8M Stainless Steel |  |             |               |
| ME842-10-107          | ME842SS-10-107       | 1-1/4" FNPT Tapped 4 Bolt Flat Face Flange Adapter | B           | 2.7           |
| ME843-10-107          | ME843SS-10-107       | 1-1/4" Socket Weld 4 Bolt Flat Face Flange Adapter | B           | 2.6           |
| ME842-12-107          | ME842SS-12-107       | 1-1/2" FNPT Tapped 4 Bolt Flat Face Flange Adapter | B           | 2.6           |
| ME843-12-107          | ME843SS-12-107       | 1-1/2" Socket Weld 4 Bolt Flat Face Flange Adapter | B           | 2.5           |
| ME842-16-107          | ME842SS-16-107       | 2" FNPT Tapped 4 Bolt Flat Face Flange Adapter     | B           | 2.2           |
| ME843-16-107          | ME843SS-16-107       | 2" Socket Weld 4 Bolt Flat Face Flange Adapter     | B           | 2.0           |

| MEC Universal Flange Kit |                      |  |             |               |
|--------------------------|----------------------|--|-------------|---------------|
| Part No.                 |                      | Description *                                      | Flange Type | Weight (lbs.) |
| WCC A216 Steel           | CF8M Stainless Steel |  |             |               |
| ME840-10F                | ME840SS-10F          | 1-1/4" FNPT 4 Bolt Flange Adapter Plate            | A           | 3.0           |
| ME841-10F                | ME841SS-10F          | 1-1/4" Socket Weld 4 Bolt Flange Adapter Plate     | A           | 2.9           |
| ME840-12F                | ME840SS-12F          | 1-1/2" FNPT 4 Bolt Flange Adapter Plate            | A           | 2.8           |
| ME841-12F                | ME841SS-12F          | 1-1/2" Socket Weld 4 Bolt Flange Adapter Plate     | A           | 2.7           |
| ME840-16F                | ME840SS-16F          | 2" FNPT 4 Bolt Flange Adapter Plate                | A           | 2.5           |
| ME841-16F                | ME841SS-16F          | 2" Socket Weld 4 Bolt Flange Adapter Plate         | A           | 2.3           |
| MEP840-10                | —                    | 1-1/4" FNPT 4 Bolt 90° Flange Adapter Elbow        | A           | 4.8           |
| MEP841-10                | —                    | 1-1/4" Socket Weld 4 Bolt 90° Flange Adapter Elbow | A           | 4.7           |
| MEP840-12                | —                    | 1-1/2" FNPT 4 Bolt 90° Flange Adapter Elbow        | A           | 4.6           |
| MEP841-12                | —                    | 1-1/2" Socket Weld 4 Bolt 90° Flange Adapter Elbow | A           | 4.6           |
| MEP840-16                | —                    | 2" FNPT 4 Bolt 90° Flange Adapter Elbow            | A           | 4.3           |
| MEP841-16                | —                    | 2" Socket Weld 4 Bolt 90° Flange Adapter Elbow     | A           | 4.2           |

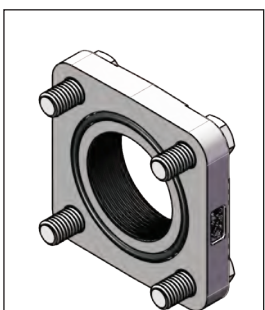

**TYPE "A"**

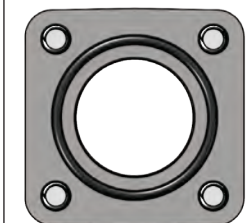

**O-RING SEAL**

\*All Flange kits include bolts and o-ring



# EXCELA-FLANGE™ SERIES

## HIGH CAPACITY 3" BOBTAIL PUMP DISCHARGE ELBOWS

These high capacity bobtail pump discharge elbows are designed to maximize the efficiency and flow rate at the outlet of the pump while minimize pressure loss due to the 90 degree directional change at the pump outlet needed to direct product to the rear of the vehicle where it is being dispensed. The MEP840H has carefully modeled radiuses and contours that allow it to flow over 50% more than other standard discharge elbows with 50% less pressure differential, thereby minimizing pump wear and maximizing pumping efficiency. When paired with other Excela-Flange™ products the bobtail can perform up to its full potential. The MEP840H series is standard with a 1/4" FNPT plugged test port and is available with NPT or socket weld outlet. Suitable for use in mobile or stationary applications.



### FEATURES

- All steel or stainless steel construction for maximum durability and weldability
- Available in 2" FNPT or 2" Socket Weld configurations
- Zinc Plated for maximum corrosion resistance
- Approved for use in LPG or NH<sub>3</sub> service
- Rated 400 WOG
- Includes mounting bolts and O-ring
- 1/4" FNPT plugged test port

| Part No.           |                      | Description   | Flange Type | Fits Pump Model(s) |
|--------------------|----------------------|---|-------------|--------------------|
| WCC A216 Steel     | CF8M Stainless Steel |   |             |                    |
| <b>MEP840H-16</b>  | <b>MEP840HSS-16</b>  | 2" FNPT 4 Bolt High Capacity 90° Flange Adapter Elbow w/ 1/2-13 Bolts & O-Ring        | Type A      | TLGLF3             |
| <b>MEP841H-16</b>  | <b>MEP841HSS-16</b>  | 2" Socket Weld 4 Bolt High Capacity 90° Flange Adapter Elbow w/ 1/2-13 Bolts & O-Ring |             | TLGLF3             |
| <b>MEP840HC-16</b> | —                    | 2" FNPT 4 Bolt High Capacity 90° Flange Adapter Elbow w/ 3/8-16 Bolts & O-Ring        | Type C      | Z3200              |
| <b>MEP841HC-16</b> | —                    | 2" Socket Weld 4 Bolt High Capacity 90° Flange Adapter Elbow w/ 3/8-16 Bolts & O-Ring |             | Z3200              |

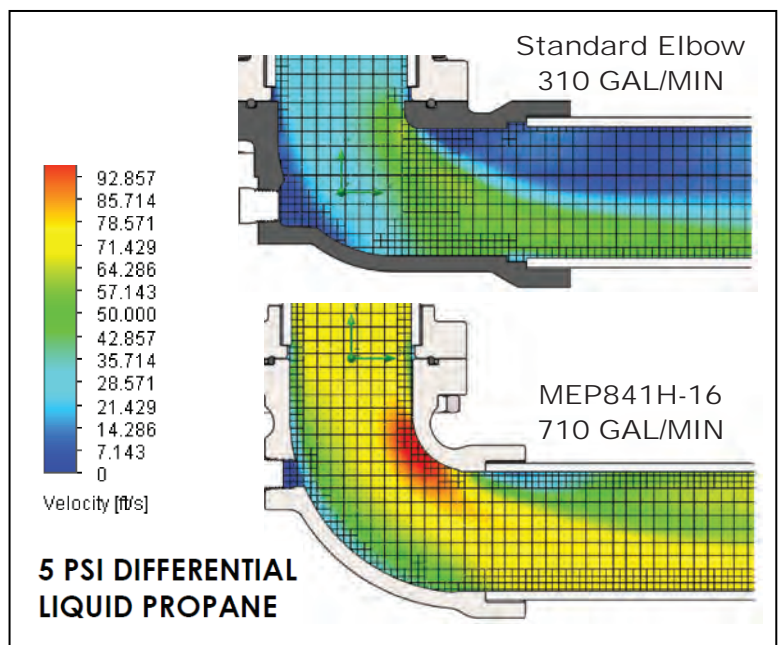
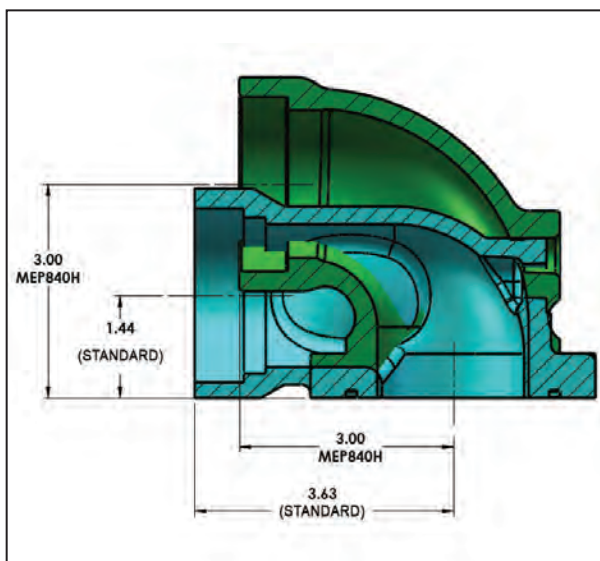

## HIGH FLOW PUMP AUXILIARY SUCTION INTAKE FLANGE ELBOWS

Specifically designed to bolt directly to 3" - 4 bolt flange auxiliary suction intake openings on standard Blackmer™ 4" TLGLF4 flange mount mobile transport trailer pumps to eliminate unwanted threaded joints. This high flow elbow allows the auxiliary intake to be oriented either forward or rear facing for applications where the pump is being hydraulically driven. The MEP841H-24/16 can be oriented for both curbside (right) or roadside (left) service or downward facing for both when used in conjunction with MEP995SBW-16 or MEP995-16.

### FEATURES

- Zinc plated WCC A216 steel or CF8M stainless steel body
- Approved for use in LPG or NH<sub>3</sub> service
- Rated 400 WOG
- Includes standard 1/4" FNPT plugged test port
- Includes mounting o-ring
- Fits Blackmer™ model TLGLF4 pumps

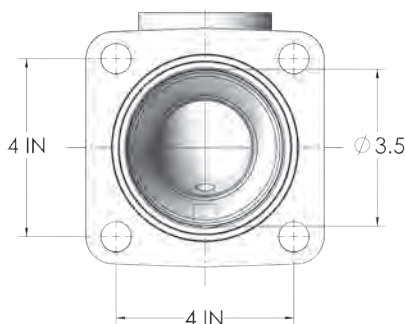

MEP841H-24/16

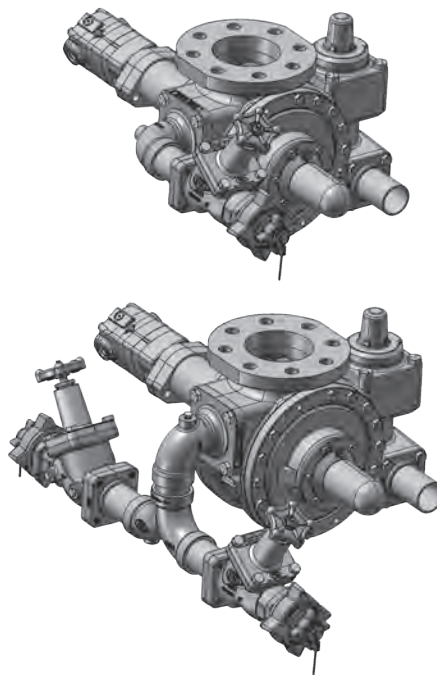

| Part No.        | Description   | Weight (lbs.) | Material             |
|-----------------|---|---------------|----------------------|
| MEP841H-24/16   | <i>Excelsa-Flange™</i> 3" - 4 Bolt (Type A) x 2" Socket Weld Auxiliary Suction Intake Elbows and O-ring | 7.36          | WCC A216 Steel       |
| MEP841HSS-24/16 |   | 7.78          | CF8M Stainless Steel |

## HIGH FLOW 4" PUMP AUXILIARY SUCTION INTAKE FLANGE ADAPTERS

Specifically designed to bolt directly to 3" - 4 bolt flange auxiliary suction intake openings on standard 4" flange mount mobile transport trailer pumps to eliminate unwanted threaded joints. The MEP998 is equipped with a 4 bolt type A flange inlet for mounting to either ME842 or ME843 series *Excelsa-Flange™* companion flanges where additional piping is desired or direct bolt onto ME819P Series *Excelsa-Flange™* globe valves for a worry-free easy to maintain auxiliary intake assembly.

### FEATURES

- Zinc plated ductile iron body
- Approved for use in LPG or NH<sub>3</sub> service
- Rated 400 WOG
- For use with all Type B (ME842 & ME843 Series) companion flanges

| Part No. | Description   | Weight (lbs.) |
|----------|---|---------------|
| MEP998   | <i>Excelsa-Flange™</i> 3" - 4 Bolt (Type A) x 2" - 4 Bolt (Type A) Auxiliary Suction Intake | 6.25          |



# VERSA-FILL™ HIGH FLOW BYPASS VALVES

## for BOBTAIL TRUCK APPLICATIONS

Versa-Fill™ Bypass Valves are designed to protect pumps from damage due to excessive pressure while providing optimal flow, maximum adjustability, versatility and performance of the pumping system. Versa-Fill features three distinct settings and functions including normal bypass, auxiliary suction evacuation/self-load and small cylinder/forklift filling mode.



**Normal Bypass Mode:** functions just like our standard ME840 Series bypass valve during domestic tank deliveries by pushing maximum pump output to the hose end delivery nozzle while protecting the pump if the nozzle is closed during delivery.



ME845C-125

PATENT PENDING

**Auxiliary Suction Evacuation/Self-Load Mode:** allows for 100% of pump flow to be diverted through a built-in full port flow control valve, permitting the pump suction inlet to be utilized for tank evacuation or self-loading without secondary manual load loop piping.



**Small Cylinder/Forklift Fill Mode:** a built in, fully adjustable proportional flow control valve allows a portion of flow from the pump to be diverted back to the tank in order to reduce flow rates at the hose end delivery nozzle to safely and accurately fill small cylinders.

### FEATURES

- Drop-in replacement to all standard bypass valves
- Repeatable flow rates for filling small cylinders such as forklift tanks - can be precisely tuned and set to match any truck's plumbing
- Evacuation/Self-load flow rates up to 125 GPM with less than 2 PSI differential pressure
- Bypass performance is equivalent to standard bypass valves
- Flexible installation options include left hand or right hand with lever control in any orientation necessary to allow easy access
- All Stainless Steel internal components and external control levers
- Ductile Iron or Stainless Steel option
- Alternative springs available: ME840-16-108-40 (20-40 PSI)  
ME840-16-108-70 (40-70 PSI)  
ME840-16-108-90 (70-90 PSI)  
ME840-16-108-150 (125-150 PSI)



| Versa-Fill™ Bypass Valves - NPT Flange Configurations |                      |   |                     |                        |
|---|----------------------|---|---------------------|------------------------|
| Part No.  |                      | Description                                     | Poppet Type         | Standard Spring Range* |
| WCC A216 Steel  | CF8M Stainless Steel |   |                     |                        |
| ME845-125   | ME845SS-125          | 1-1/4" - 2" Versa-Fill Bypass Valve w/o flanges | Standard/ High Flow | 90-125 PSI             |
| ME845C-125  | ME845CSS-125         |   | Classic Flow        |                        |
| ME845-10-125  | ME845SS-10-125       | 1-1/4" FNPT Versa-Fill Bypass Valve             | Standard/ High Flow |                        |
| ME845C-10-125   | ME845CSS-10-125      |   | Classic Flow        |                        |
| ME845-12-125  | ME845SS-12-125       | 1-1/2" FNPT Versa-Fill Bypass Valve             | Standard/ High Flow |                        |
| ME845C-12-125   | ME845CSS-12-125      |   | Classic Flow        |                        |
| ME845-16-125  | ME845SS-16-125       | 2" FNPT Versa-Fill Bypass Valve                 | Standard/ High Flow |                        |
| ME845C-16-125   | ME845CSS-16-125      |   | Classic Flow        |                        |

\* Alternate spring ranges available. Please see replacement parts section



| Versa-Fill™ Bypass Valves - Weld Flange Configurations |                      |   |                        |
|--|----------------------|---|------------------------|
| Part No.   |                      | Description   | Standard Spring Range* |
| WCC A216 Steel   | CF8M Stainless Steel |   |                        |
| ME846S-10/125  | ME846SS-10/125       | 1-1/4" Weld Flange High Flow Versa-Fill Bypass Valve    | 90-125 PSI             |
| ME846-12/125   | ME846SS-12/125       | 1-1/2" Weld Flange High Flow Versa-Fill Bypass Valve    |                        |
| ME846-16/125   | ME846SS-16/125       | 2" Weld Flange High Flow Versa-Fill Bypass Valve        |                        |
| ME846C-10/125  | ME846SSC-10/125      | 1-1/4" Weld Flange Classic Flow Versa-Fill Bypass Valve |                        |
| ME846C-12/125  | ME846SSC-12/125      | 1-1/2" Weld Flange Classic Flow Versa-Fill Bypass Valve |                        |
| ME846C-16/125  | ME846SSC-16/125      | 2" Weld Flange Classic Flow Versa-Fill Bypass Valve     |                        |



\* Alternate spring ranges available. Please see options under features

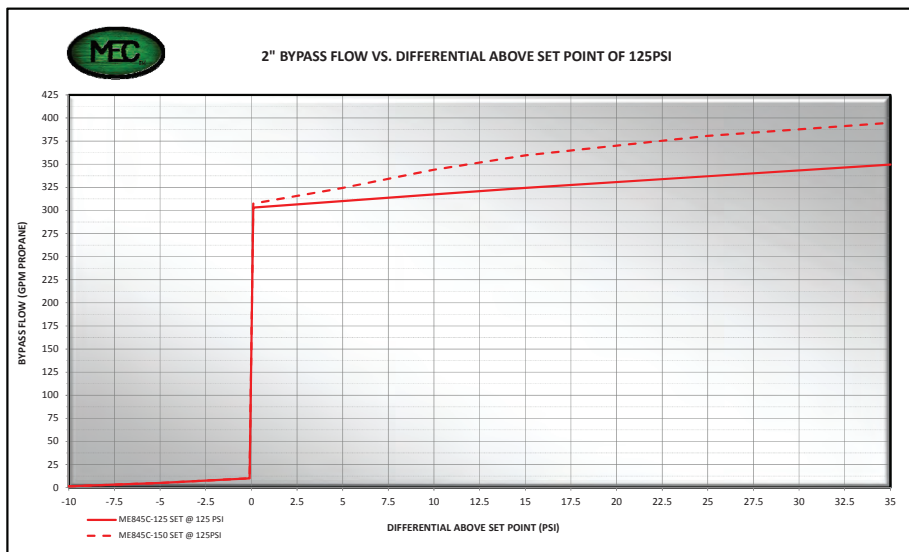
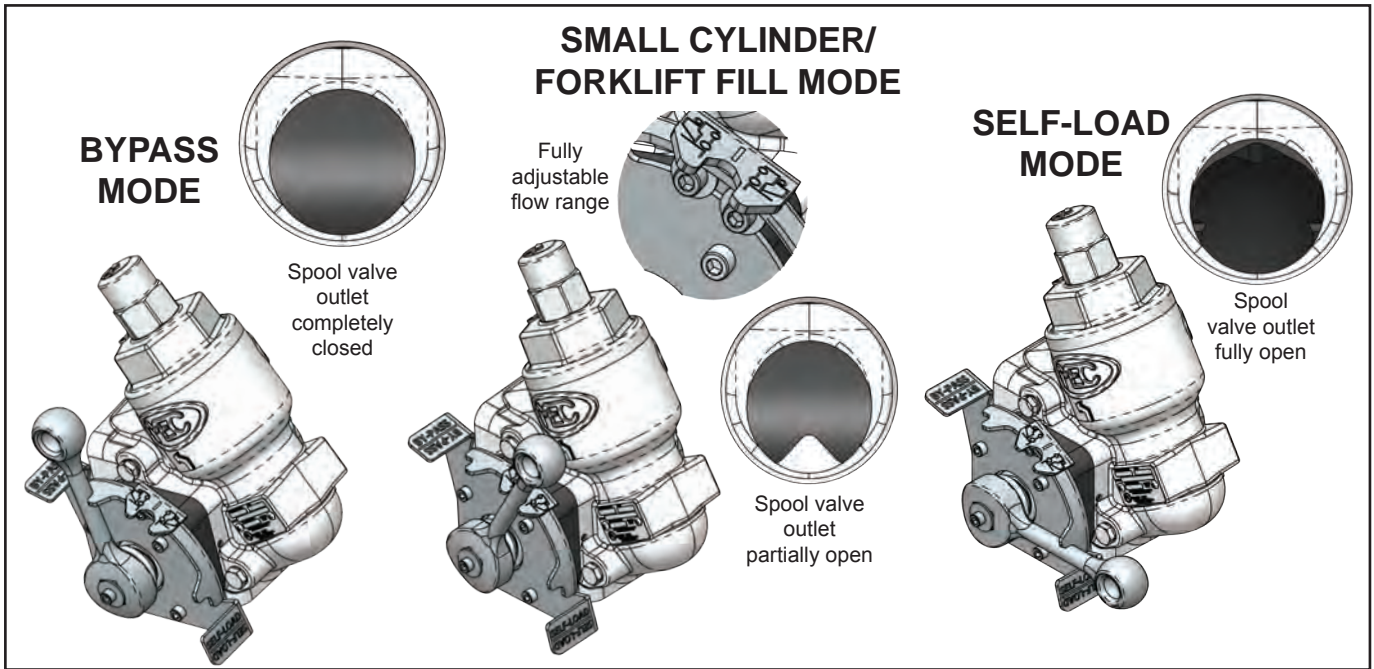

\*Designed to create higher differential pressure and increased poppet travel in low flow applications such as bobtails





# HIGH FLOW BYPASS VALVES

## FOR BOBTAIL TRUCK / PLANT APPLICATIONS

These bypass valves are specifically designed to protect truck and plant pumps from damage due to excessive pressure while providing the industry's best bypass flow rates across a full range of set pressures. They feature wide open flow channels with an orifice weep hole chamber to prevent the valve from slamming open / closed. The weep hole chamber also helps prevent valve seat chatter by allowing constant pressure communication between both the upstream and downstream side of the seat.

### FEATURES

- All ductile iron body and bonnet or stainless steel option
- All stainless steel wetted components
- Heavy duty protective stem cap
- Wide open flow channels for industry best flow rates
- Orifice weep hole to maintain constant pressure above and below valve seat
- Large range of set pressure springs
- Weldable steel NPT and socket weld flanges
- Zinc dichromate finish for maximum corrosion resistance
- Available with or without flanges factory assembled
- Flanges available 1-1/4" through 2" NPT and socket weld construction
- Universal 4 bolt, flanged body configuration
- Two 1/4" FNPT plugged auxiliary pressure ports
- Factory set at 125 PSI
- Alternative springs available: ME840-16-108-40 (20-40 PSI)  
ME840-16-108-70 (40-70 PSI)  
ME840-16-108-90 (70-90 PSI)  
ME840-16-108-150 (125-150 PSI)



ME840-16/125



| Bypass Valves - NPT Flange Configurations |                      |   |                                      |                            |
|---|----------------------|---|--------------------------------------|----------------------------|
| Part No.                                  |                      | Description   | Standard Spring Range <sup>(1)</sup> | Flange Type <sup>(2)</sup> |
| WCC A216 Steel                            | CF8M Stainless Steel |   |                                      |                            |
| ME840-10-125                              | ME840SS-10-125       | 1-1/4" FNPT High Flow Bypass Valve                  | 90-125 PSI                           | A                          |
| ME840C-10-125                             | ME840SSC-10-125      | 1-1/4" FNPT Classic Flow Bypass Valve               |                                      | A                          |
| ME840-12-125                              | ME840SS-12-125       | 1-1/2" FNPT High Flow Bypass Valve                  | 90-125 PSI                           | A                          |
| ME840C-12-125                             | ME840SSC-12-125      | 1-1/2" FNPT Classic Flow Bypass Valve               |                                      | A                          |
| ME840-16-125                              | ME840SS-16-125       | 2" FNPT High Flow Bypass Valve                      | 90-125 PSI                           | A                          |
| ME840C-16-125                             | ME840SSC-16-125      | 2" FNPT Classic Flow Bypass Valve                   |                                      | A                          |
| ME840-125                                 | ME840SS-125          | 1-1/4"-2" Universal High Flow Bypass w/o Flanges    | 90-125 PSI                           | B                          |
| ME840C-125                                | ME840SSC-125         | 1-1/4"-2" Universal Classic Flow Bypass w/o Flanges |                                      | B                          |



ME840-16-104  
Standard Poppet

(1) Alternate spring ranges available. Please see replacement parts section in back of catalog  
(2) See page 67 for flange options

| Bypass Valves - Weld Flange Configurations |                      |  |                                      |                            |
|--|----------------------|--|--------------------------------------|----------------------------|
| Part No.                                   |                      | Description                                  | Standard Spring Range <sup>(1)</sup> | Flange Type <sup>(2)</sup> |
| WCC A216 Steel                             | CF8M Stainless Steel |  |                                      |                            |
| ME841-10-125                               | ME841SS-10-125       | 1-1/4" Weld Flange High Flow Bypass Valve    | 90-125 PSI                           | A                          |
| ME841C-10-125                              | ME841SSC-10-125      | 1-1/4" Weld Flange Classic Flow Bypass Valve |                                      | A                          |
| ME841-12-125                               | ME841SS-12-125       | 1-1/2" Weld Flange High Flow Bypass Valve    | 90-125 PSI                           | A                          |
| ME841C-12-125                              | ME841SSC-12-125      | 1-1/2" Weld Flange Classic Flow Bypass Valve |                                      | A                          |
| ME841-16-125                               | ME841SS-16-125       | 2" Weld Flange High Flow Bypass Valve        | 90-125 PSI                           | A                          |
| ME841C-16-125                              | ME841SSC-16-125      | 2" Weld Flange Classic Flow Bypass Valve     |                                      | A                          |



ME840C-16-104  
Classic Poppet  
\*Designed to create higher differential pressure and increased poppet travel in low flow applications such as bobtails

(1) Alternate spring ranges available. Please see replacement parts section in back of catalog  
(2) See page 67 for flange options



## FOR DISPENSING APPLICATIONS

Intended for use in small cylinder filling applications as a bypass and primer valve for turbine style dispensing pumps. These bypass valves feature a special "check ball" mechanism that helps eliminate vapor from liquid while keeping the pump flooded and properly primed. The priming and vapor elimination features in combination with the high flow bypass design significantly reduces pump wear and promotes seal longevity.

### FEATURES

- Ductile iron body and bonnet construction
- Large range of set pressure springs
- Two 1/4" FNPT plugged auxiliary pressure ports (outlet side)
- Stainless steel main valve poppet
- Heavy duty protective stem cap
- Available in 3/4" & 1" FNPT threaded versions
- Factory set at 125 PSI
- Durable powder coat finish
- Alternative springs available: ME840-8-108-60 (25-60 PSI)  
ME840-8-108-225 (100-225 PSI)

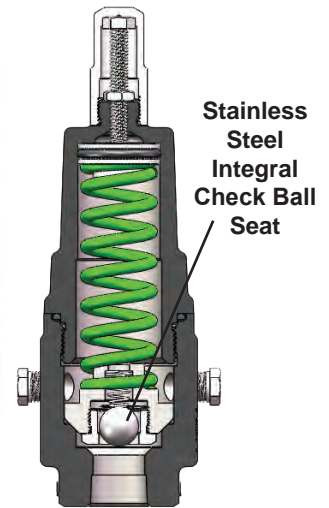

| Part No.    | Description                      | Standard Spring Range* |
|-------------|----------------------------------|------------------------|
| ME840-6-150 | 3/4" FNPT High Flow Bypass Valve | 50-150 PSI             |
| ME840-8-150 | 1" FNPT High Flow Bypass Valve   | 50-150 PSI             |

\* Alternate spring ranges available. Please see replacement parts section in back of catalog



## FOR PLANT APPLICATIONS

Specifically designed for plant systems where maximum bypass flow is necessary to protect the pump from rapid pressure changes or over pressurization. Perfectly suited for 4" base mount pumps or larger pump applications.

### FEATURES

- Ductile iron body and bonnet construction
- All stainless steel internal wetted components
- Bonnet / seat positioned at 35° angle for maximum product flow
- Downstream bleed port to boost product flow during bypass
- Two 1/4" FNTP plugged auxiliary pressure ports
- Heavy duty protective stem cap
- Factory set at 100 PSI
- Durable powder coat finish



| Part No.        | Description                             | Standard Spring Range* |
|-----------------|---|------------------------|
| ME840-24-100    | 3" FNPT High Flow Bypass Valve          | 50-100 PSI             |
| ME840-24-200    | 3" FNPT High Flow Bypass Valve          | 100-200 PSI            |
| ME840-24-3F-100 | 3" -300# Flanged High Flow Bypass Valve | 50-100 PSI             |
| ME840-24-3F-200 | 3" -300# Flanged High Flow Bypass Valve | 100-200 PSI            |

\* Alternate spring ranges available. Please see replacement parts section in back of catalog



# HOSE END VALVES

## HIGH FLOW & LOW EMISSION

These hose end valves are leading the industry in minimal product loss during disconnect without sacrificing flow. They have instant full-on flow with the added protection of a quick closing, self-locking handle to prevent accidental opening of the valve during transport. They are designed to be used at the end of a filling hose on a bobtail, dispensing system or nurse tank.

### FEATURES

- All stainless steel component construction
- Molded and riveted on valve main seal
- Vents less than .50cc for minimal loss of product at disconnect
- Self-locking toggle handle prevents accidental valve opening
- Toggle handle and stem assembly rotate 360°
- Durable ductile iron valve body with automotive grade powder coat finish
- Stainless steel 1-3/4" female Acme insert cast into the handle
- No additional adapters or connectors needed for operation
- Optional extended version offers 6 inches of additional reach for filling underground containers or other hard to reach applications
- Optional composite style offers a durable lightweight handle that is resistant to frosting and cold transfer during the filling operation
- Optional factory installed **E-ZTurn** stainless steel swivel
- **NOW AVAILABLE WITH FKM seals for endurance of high temperatures, contaminated gas, propylene gas as well as many hydrocarbon gases.**

### HIGH FLOW DESIGN

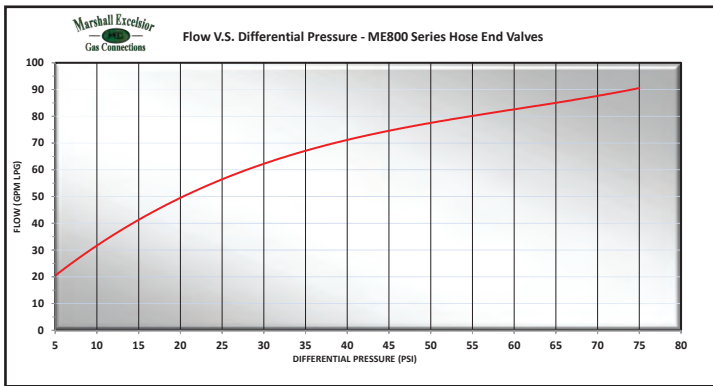

| Part No.   | Inlet (FNPT) | Outlet (F. Acme) | Application |                   | Handle Style | Handle Material | Factory Installed E-Z Turn Swivel | Extended Version | Accessories |
|------------|--------------|------------------|-------------|-------------------|--------------|-----------------|-----------------------------------|------------------|-------------|
|            |              |                  | LPG         | NH <sub>3</sub> * |              |                 |                                   |                  | Holster     |
| ME800 *    | 1"           | 1-3/4"           | Yes         | Yes               | Standard     | Aluminum        | No                                | No               | MEP801      |
| ME800-6 *  | 3/4"         | 1-3/4"           | Yes         | Yes               | Standard     | Aluminum        | No                                | No               | MEP801      |
| ME800WS    | 1"           | 1-3/4"           | Yes         | Yes               | Standard     | Aluminum        | Yes                               | No               | MEP801      |
| ME800C     | 1"           | 1-3/4"           | Yes         | Yes               | Standard     | Composite       | No                                | No               | MEP801      |
| ME800CWS   | 1"           | 1-3/4"           | Yes         | Yes               | Standard     | Composite       | Yes                               | No               | MEP801      |
| ME800G *   | 1"           | 1-3/4"           | Yes         | Yes               | Fluted       | Aluminum        | No                                | No               | MEP801      |
| ME800G-6 * | 3/4"         | 1-3/4"           | Yes         | Yes               | Fluted       | Aluminum        | No                                | No               | MEP801      |
| ME800GWS   | 1"           | 1-3/4"           | Yes         | Yes               | Fluted       | Aluminum        | Yes                               | No               | MEP801      |
| ME800GC    | 1"           | 1-3/4"           | Yes         | Yes               | Fluted       | Composite       | No                                | No               | MEP801      |
| ME800GCWS  | 1"           | 1-3/4"           | Yes         | Yes               | Fluted       | Composite       | Yes                               | No               | MEP801      |
| ME800EXT * | 1"           | 1-3/4"           | Yes         | Yes               | Standard     | Aluminum        | No                                | Yes              | No          |
| ME800EXTWS | 1"           | 1-3/4"           | Yes         | Yes               | Standard     | Aluminum        | Yes                               | Yes              | No          |



\* To order FKM seal materials add "V" after the prefix part number - i.e. ME800V, ME800GV-6  
 WARNING - FKM seal materials are not compatible with NH<sub>3</sub> use



# HOSE END VALVE LOCK

Designed to prevent valve operation while in place, eliminating the possibility of accidental discharge and/or theft of product. Simply slide the lock over the handle/bonnet of the hose end or quick acting dispensing valve. For maximum security a common padlock can be installed.

## FEATURES

- All stainless steel construction
- 3/8" diameter through holes for standard 2-1/2" shackle style padlock

| Part No.     | Fits                       | Accessories                 |                 |
|--------------|----------------------------|-----------------------------|-----------------|
|              |                            | 2-1/2" Deep Shackle Padlock |                 |
|              |                            | Keyed Alike                 | Keyed Different |
| <b>ME540</b> | ME800, ME810, ME820 Series | ME540P-KA                   | ME540P-KD       |



# HOSE END VALVE HOLSTERS

Designed to provide a durable and convenient receptacle to store bobtail hose end delivery valves during over-the-road transit. This holster can be mounted fully above deck or partially below deck in left or right hand hose reel applications with an ergonomic angle providing optimum conditions for delivery personnel.

## FEATURES

- All aluminum and stainless steel construction
- Urethane anti-vibration valve sleeve to prevent incidental damage to delivery valve
- Machined adjustment ribs for easy, secure height adjustment
- Deck backing plate and all mounting hardware supplied



**MEP801**



**MEP802**



**MEP804**

| Part No.      | Description   | Fits   | Accessories   |
|---------------|---|--|---|
| <b>MEP801</b> | Bobtail Hose End Valve Holster - Aluminum                               | ME800 Series                                       | MEP801H<br>(Urethane Weather Hood)  |
| <b>MEP802</b> | Bobtail Hose End Valve Holster - Aluminum w/ All Weather Hood           | ME800 Series                                       | MEP801-04<br>(Urethane Holster Strap)                                       |
| <b>MEP804</b> | Bobtail Quick-Jaw Hose End Valve Holster - Aluminum w/ All Weather Hood | ME800 Series,<br>AL363 or AL366<br>(Squibb Taylor) | MEP801H<br>(Urethane Weather Hood)<br>MEP801-04<br>(Urethane Holster Strap) |



# HOSE END SWIVEL CONNECTIONS

The **E-ZTurn** hose end swivel connector allows the hose end valve to rotate 360° creating an easier connection to the tank filler valve while under pressure. It also promotes hose life by preventing twisting and kinking during reeling and unreeling from hose reel.



## FEATURES

- All stainless steel construction for maximum durability and corrosion resistance
- Large bearing surface for increased strength and durability
- 360° rotation under maximum working pressure of 400 psig
- Our  LISTED seal pack design allows for extremely long life with no maintenance required
- Straight through bore for unobstructed flow characteristics
- See low emission hose end valves for factory installed **E-ZTurn**



For LP-Gas & NH<sub>3</sub>

| Part No.     | Inlet (FNPT) | Outlet (MNPT) |
|--------------|--------------|---------------|
| ME850SS-6    | 3/4"         | 3/4"          |
| ME850SS-6/8  | 3/4"         | 1"            |
| ME850SS-8    | 1"           | 1"            |
| ME850SS-8/6  | 1"           | 3/4"          |
| ME850SS-10/8 | 1-1/4"       | 1"            |

# GROUNDING STUD

Designed to help prevent static electricity from being generated due to friction from the pump. In some cases static electricity can build-up enough to create an ignition source and cause an explosion.

| Part No. | Thread  |
|----------|---------|
| ME4H     | 3/8"-16 |



# SMART INTERLOCK TECHNOLOGY

Designed to prevent a vehicle from being operated while the hose end delivery valve, loading line or wheel chocks are in use. The smart interlock technology connects directly to the Allison Automatic Transmission through the "Auxiliary Function Range Inhibit" or braking system for manual transmission vehicles. This revolutionary system incorporates the industry's best and most durable sensor, TURCK - which is backed with a lifetime product warranty.

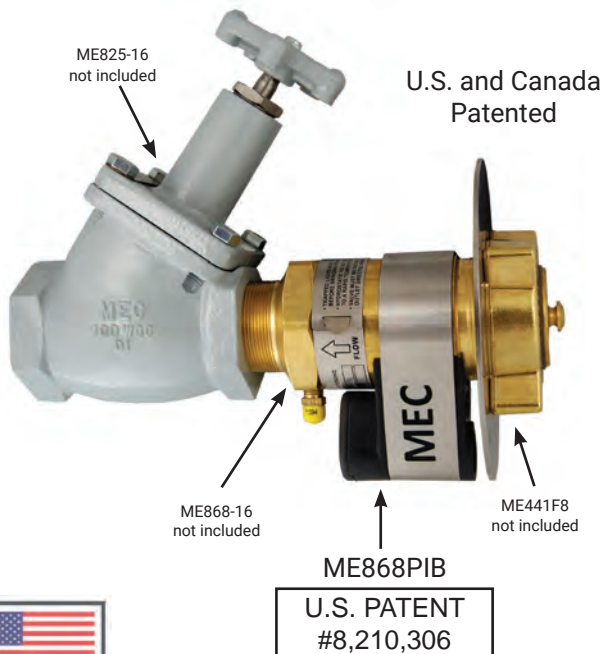

## MEC SMART INTERLOCK TECHNOLOGY FEATURES

- "Potted" TURCK proximity switch for maximum weather resistance and security against vibration
- Supplied with water tight conduit and necessary wiring hardware to reach 5' below deck with water tight receptacle plug

## SENSOR BRACKET ASSEMBLY FEATURES

- Smart interlock technology
- Molded urethane sensor body housing for durability and maximum sensor protection
- Stainless steel all weather mounting band and hardware



# SMART INTERLOCK TECHNOLOGY



ME200PIBK



ME217PIB



ME890PIB



MEP801PIH  
ME800  
Not Included

U.S. PATENT  
#8,132,639



MEP801PIK

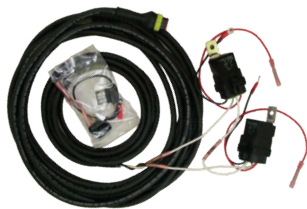

MEP802PCK/20

| Part No.   | Description   | Temperature Range | Accessories  |
|------------|---|-------------------|--|
| ME200PIB   | Sensor Bracket Assembly for ME200 Wheel Chocks                                  | -20° to +160° F.  | ME200EXT (Standoff Extension Kit)  |
| ME200PIBK  | Sensor Bracket Assembly with ME200 Wheel Chocks                                 | -20° to +160° F.  |  |
| ME217PIB   | Sensor Bracket Assembly for ME217 Series  | -20° to +160° F.  | MEP801PC/20 (20' Proximity Cable)<br>MEP801PC/30 (30' Proximity Cable)<br>Includes Water Tight Receptacle Plug |
| ME503PIB   | Sensor Bracket Assembly for ME503-16 & ME252-16                                 | -20° to +160° F.  |  |
| ME807PIB   | Sensor Bracket Assembly for ME807 Series  | -20° to +160° F.  |  |
| ME808PIB   | Sensor Bracket Assembly for ME808 Series  | -20° to +160° F.  |  |
| ME868PIB   | Sensor Bracket Assembly for ME868 Valve Series                                  | -20° to +160° F.  |  |
| MEP801PIH  | Sensor Assembly with MEP801 Hose End Valve Holster                              | -20° to +160° F.  |  |
| MEP802PIH  | Holster W/Proximity Interlock Sensor Assembly with All Weather Hood             | -20° to +160° F.  |  |
| MEP804PIH  | Bobtail Quick-Jaw Hose End Valve Holster w/ Proximity Interlock Sensor Assembly | -20° to +160° F.  |  |
| MEP801PIK  | Interlock Retro Fit Kit for MEP801 Hose End Valve Holster                       | -20° to +160° F.  |  |
| MEP801PIKL | Low Temperature Interlock Retro Fit Kit for MEP801 Hose End Valve Holster       | -50° to +160° F.  |  |
| ME890PIB   | Universal Sensor Bracket Assembly for Enclosures                                | -20° to +160° F.  |  |

| Smart Interlock Technology Wiring Harness Kits |                    |               |                     |             |              |                                      |
|--|--------------------|---------------|---------------------|-------------|--------------|--------------------------------------|
| Part No.                                       | Description        | No. of Relays | LED Power Indicator | Inline Fuse | Cable Length | Accessories                          |
| MEP801PCK/20                                   | Wiring Harness Kit | 1             | Yes                 | Yes         | 20'          | MEP801PC/20 (20' Proximity Cable)    |
| MEP801PCK/30                                   |                    | 1             | Yes                 | Yes         | 30'          |                                      |
| MEP802PCK/20                                   |                    | 2 (1)         | Yes                 | Yes         | 20'          | MEP801PC/30 (30' Proximity Cable)    |
| MEP802PCK/30                                   |                    | 2 (1)         | Yes                 | Yes         | 30'          |                                      |
| MEP803PCK/30                                   |                    | 3 (2)         | Yes                 | Yes         | 30'          | Includes Water Tight Receptacle Plug |

(1) One additional cable required (MEP801PC/20 or MEP801PC/30)  
 (2) Two additional cables required (MEP801PC/20 or MEP801PC/30)



# QUICK ACTING DISPENSING VALVES

Dispensing valves are designed to be used at the end of a filling hose for bobtail, dispensing system or nurse tank filling operations. These valves have instant full-on flow with the added protection of a quick closing, self-locking handle to prevent accidental opening of the valve during transport.

## FEATURES

- All stainless steel internal components
- Self-locking toggle handle prevents accidental operation
- Durable ductile iron valve body with automotive grade powder coat finish
- Toggle handle and stem assembly rotate 360°
- Stainless steel factory installed vent valve



**ME810 Series**



**ME820 Series**

| Part No.       |                | Inlet & Outlet (FNPT) | No. of Side Ports | Accessories                  |                   |                     |
|----------------|----------------|-----------------------|-------------------|------------------------------|-------------------|---------------------|
| Angle          | Globe          |                       |                   | MNPT x 1-3/4 F. Acme Adapter |                   |                     |
|                |                |                       |                   | Short Brass                  | Short Steel *     | Extended Steel *    |
| <b>ME810-4</b> | <b>ME820-4</b> | 1/2"                  | 1                 | ME110<br>ME110C              | —                 | ME635-4<br>ME635G-4 |
| <b>ME810-6</b> | <b>ME820-6</b> | 3/4"                  | 1                 | ME111<br>ME111C              | ME111S<br>ME111SC | ME635-6<br>ME635G-6 |
| <b>ME810-8</b> | <b>ME820-8</b> | 1"                    | 1                 | ME112<br>ME112C              | ME112S<br>ME112SC | ME635-8<br>ME635G-8 |

\* Rated for LP-Gas & NH<sub>3</sub>



**ME821 Series**



| Part No.                       | Body Style | Inlet & Outlet (FNPT) | No. of Side Ports | Accessories                  |                            |                               |
|--------------------------------|------------|-----------------------|-------------------|------------------------------|----------------------------|-------------------------------|
|                                |            |                       |                   | MNPT x 1-3/4 F. Acme Adapter |                            |                               |
|                                |            |                       |                   | Short Brass                  | Short Steel <sup>(1)</sup> | Extended Steel <sup>(1)</sup> |
| <b>ME821-4</b>                 | Globe      | 1/2"                  | 2                 | ME110<br>ME110C              | —                          | ME635-4<br>ME635G-4           |
| <b>ME821-6</b>                 | Globe      | 3/4"                  | 2                 | ME111<br>ME111C              | ME111S<br>ME111SC          | ME635-6<br>ME635G-6           |
| <b>ME821B-4 <sup>(2)</sup></b> | Globe      | 1/2"                  | 2                 | ME110<br>ME110C              | —                          | ME635-4<br>ME635G-4           |
| <b>ME821B-6 <sup>(2)</sup></b> | Globe      | 3/4"                  | 2                 | ME111<br>ME111C              | ME111S<br>ME111SC          | ME635-6<br>ME635G-6           |

(1) Rated for LP-Gas & NH<sub>3</sub>

(2) Includes MEJ400 Brass Vent Valve

## FEATURES

- All stainless steel internal components
- Reduced size and weight for easier handling
- Self-locking toggle handle prevents accidental operation
- Durable ductile iron valve body with automotive grade powder coat finish
- Toggle handle and stem assembly rotate 360°
- Factory installed 1/4" FNPT plugged ports



# HOSE END FILL ADAPTERS

These adapters are intended to be attached to the LP-Gas delivery truck hose outlets. They feature minimal flow restriction which allows for fast delivery while providing an integral check valve to prevent further product loss if the tank fill valve fails to close. In the event the tank fill valve should fail, leave the fill adapter connected to the fill valve and disconnect the filler hose end valve. Then place the filler valve cap onto the fill adapter. The tank fill valve should be repaired immediately.

To increase flow up to 30 percent over standard hose end filler adapters use the ME578 hose end fill adapter. It is a full-flow, manually operated hose end fill adapter where the user controls whether the valve is open or closed, providing maximum protection against product discharge.

ME570



ME571



ME572



ME571H



ME574



ME578



ME574EXT



ME572EXTHD



## FEATURES

- Integral breakaway feature in the event of truck roll away leaving check intact on tank
- ME570, ME572, ME574, ME578 shortest overall height in the industry allowing adapters to fit inside tank hood
- ME571 has a floating internal seat design which allows check to swivel freely when installed on hose end valve
- ME571H has same features as standard ME571 but with 30% MORE FLOW
- ME578 has a full-port design which allows for full flow
  - Removable shutoff key and key ring supplied
- Extended versions provide an additional 7" for use on underground tanks
  - Prevents pinching or cutting of the delivery hose on the protective tank collar
  - Eliminates dangerous extensions that do not incorporate the appropriate fill check device
  - Eliminates unsafe stacking of multiple fill check adapters to obtain the desirable fill connection height
  - Overall length allows adapter to fit inside protective tank collar
  - Optional heavy duty aluminum handle with a stainless steel 1-3/4" female Acme insert cast into the handle.

| Part No.   | Filler Valve F. Acme Connection | Hose End M. Acme Connection | Handle Style | Handle Material | Swivels | Factory Installed Vent Valve | Extended Version OAL (2) | Additional Keys |
|------------|---------------------------------|-----------------------------|--------------|-----------------|---------|------------------------------|--------------------------|-----------------|
| ME570      | 1-3/4"                          | 1-3/4"                      | Standard     | Brass           | No      | No                           | —                        | —               |
| ME571      | 1-3/4"                          | 1-3/4"                      | Standard     | Brass           | Yes (1) | No                           | —                        | —               |
| ME571H     | 1-3/4"                          | 1-3/4"                      | Standard     | Brass           | Yes (1) | No                           | —                        | —               |
| ME572      | 1-3/4"                          | 1-3/4"                      | Standard     | Brass           | Yes     | No                           | —                        | —               |
| ME572EXT   | 1-3/4"                          | 1-3/4"                      | Standard     | Brass           | Yes     | No                           | 7.789"                   | —               |
| ME572EXTHD | 1-3/4"                          | 1-3/4"                      | Heavy Duty   | Cast Aluminum   | Yes     | No                           | 7.790"                   | —               |
| ME574      | 1-3/4"                          | 1-3/4"                      | Standard     | Brass           | Yes     | Yes                          | —                        | —               |
| ME574EXT   | 1-3/4"                          | 1-3/4"                      | Standard     | Brass           | Yes     | Yes                          | 7.789"                   | —               |
| ME574EXTHD | 1-3/4"                          | 1-3/4"                      | Heavy Duty   | Cast Aluminum   | Yes     | Yes                          | 7.790"                   | —               |
| ME578      | 1-3/4"                          | 1-3/4"                      | Standard     | Brass           | Yes     | No                           | —                        | ME578-02        |
| ME578C     | 1-3/4"                          | 1-3/4"                      | Heavy Duty   | Brass           | Yes     | No                           | —                        | ME578-02        |

(1) ME571 and ME571H allows the hose end valve to swivel while connected to the filler hose end adapter

(2) OAL includes free-spinning ACME caps





# EXCESS FLOW WARNING

An excess flow valve is a protective device to help control the discharge of product in the event of complete breakage of pipe lines or hose rupture. However, an excess flow valve can only offer limited protection from gas discharge, because it will only close under those conditions which cause the flow through the valve to exceed its rated closing flow, and even when closed it necessarily allows some “bleed” past the valve.

Excess flow check valves have helped minimize gas loss in many incidents involving breakage of hoses and transfer piping. Thus, they do provide a useful safety function in LP-Gas systems. However, there have also been transfer system accidents where excess flow valves have been ineffective in controlling gas loss due to a variety of conditions and to the inherent limitations of these valves. This bulletin explains the protection excess flow valves can offer, points out conditions which can interfere with that protection, and offers suggestions for effective excess flow valve installation.

If any of the following conditions are present, an excess flow valve is not designed to close and may not provide protection:

1. The piping system restrictions (due to pipe length, branches, reduction in pipe size, or number of other valves) decrease the flow rate to less than the valve’s closing flow. (Valve should be selected by closing flow rating—not just by pipe size).
2. The break or damage to the downstream line is not large enough to allow enough flow to close the valve.
3. A shutoff valve in the line is only partially open and will not allow enough flow to close the excess flow valve.
4. LP-Gas pressure upstream of the excess flow valve, particularly due to low temperature, is not high enough to produce a closing flow rate.
5. Foreign matter is lodged in the valve and prevents closing.
6. A build-up of process material, which may be found in LP-Gas, may occur over a period of time causing the valve to stick open and prevent proper operation.
7. The piping break or damage occurs upstream of an in-line excess flow valve, so the escaping product is not passing through the valve.
8. The flow through the valve is in the wrong direction. (Excess flow valves only respond to flow in one direction.)
9. The excess flow valve has been damaged, or is otherwise not in operating condition.

Excess flow valves have numerous conditions where the valve may not operate correctly and should not be the sole means in the event a pipe is damaged and product needs to be controlled. It is recommended that another shutoff protection device be installed in addition to or instead of an excess flow valve to control the escape of product when a pipe is damaged.

Where excess flow valves are installed, they should be checked to see that:

1. They are installed in the correct direction—the arrow on the valve indicates the shutoff direction. (Excess flow valves only respond to flow in one direction.)
2. The flow rating on the valve is proper for the installation. The rating must be above the normal system flow, but no higher than necessary, to prevent “nuisance” closing in normal conditions. If the manufacturer’s catalog information is not sufficient, the valve suppliers can provide sizing assistance.
3. To help avoid separating the upstream piping and valve, an in-line excess flow valve is installed to help pipe damage occur downstream.

When the excess flow valves can be examined separate from the line (before the installation or if removed for system maintenance), they should be checked to see that the parts are in good condition and that the poppet can be pushed fully closed.

## Testing of Excess Flow Valves

In order to test an excess flow valve in a piping system, the flow through the valve must exceed the valve’s closing rating. This test should only be attempted by trained personnel familiar with the process. If no one at the facility has experience in proper testing, outside expert help should be obtained. The exact procedure used may vary with the installation, gas discharge exposure, and availability of equipment.

In general, most testing makes use of the fact that excess flow valves are “surge sensitive” and will close quicker under a sudden flow surge than under steady flow. A sufficient surge can often be created by using a quick closing valve to control sudden, momentary flow into a tank or piping section containing very low pressure. An audible click from the excess flow valve (and corresponding stoppage of flow) indicates its closure.

A test involving venting gas to the atmosphere is hazardous and may be impractical or illegal.

Any test of any excess flow valve will not prove that the valve will close in an emergency situation, due to reasons cited before. This test will only check the valve’s condition, and the flow rate sizing for those test conditions.

For additional information on excess flow valves contact your local distributor, Marshall Excelsior and refer to NFPA 58.



# EXCELA-FLANGE™ EXCESS FLOW VALVES

MEC offers the largest closing flow selection in the industry. These excess flow valves are intended for use in liquid or vapor LP-Gas or NH<sub>3</sub> systems. These valves can be used for filling, withdrawal and vapor equalization in containers or line applications, specifically long lines or branch piping. This product is designed to protect against excessive discharge as a result of a break in the hose or piping system. The excess flow feature is designed to remain closed after activation until the system pressure equalizes on both sides of the shutoff poppet.

The ME883S-16 Series valves feature our new modular **Excelsa-Flange™** 4 bolt inlet flange design that can be easily adapted to both NPT thread or socket weld type B companion flanges ranging from 1-1/4" to 2" in diameter making it universal to piping sizes within this range. This innovative system allows installers the ability to eliminate unnecessary extra connections as well as possible leak points by integrating a convenient 4 bolt flange union at the valve inlet.

**WARNING:** An excess flow valve will not activate if there is a break or leak downstream of the valve that does not equal or exceed the closing flow of the valve or if the excess flow valve installed exceeds the flow capacity of the system. See the Excess Flow Warning page for more information regarding the use of excess flow devices.

## FEATURES

- All models feature stainless steel stem, spring and valve guide
- Valve body: Ductile Iron / Shutoff poppet assy: zinc plated steel & stainless steel
- Available 2" NPT x 4 Bolt Type A Flange
- All models can be used with LP Gas or NH<sub>3</sub>
- Available in a wide variety of closing flow rates - see chart below
- **2" models available with CF8M Stainless Steel body & bonnet**

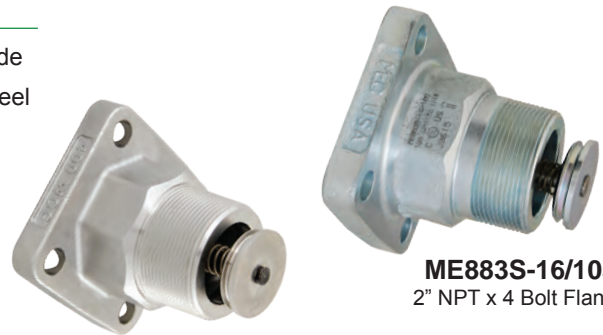

**ME883S-16/105**  
2" NPT x 4 Bolt Flange

**ME883SS-16/105**  
SS 2" NPT x 4 Bolt Flange

| Part No.*            |                       | Description   | Closing Flow | Mating Flange Type | Weight (lbs.) |                 |
|----------------------|-----------------------|---|--------------|--------------------|---------------|-----------------|
| Ductile Iron         | CF8M Stainless Steel  |   |              |                    | Ductile       | Stainless Steel |
| <b>ME883S-10/42</b>  | —                     | 1-1/4" MNPT x 4 Bolt Type A Flange Excess Flow                  | 42           | B                  | 4.1           | 3.5             |
| <b>ME883S-16/80</b>  | <b>ME883SS-16/80</b>  | 2" MNPT x 4 Bolt Type A Flange Excess Flow                      | 80           |                    | 4.1           | 3.5             |
| <b>ME883S-16/105</b> | <b>ME883SS-16/105</b> |   | 105          |                    | 4.23          | 4.0             |
| <b>ME883S-16/105</b> | <b>ME883SS-16/105</b> |   | 114          |                    | 4.23          | 4.0             |
| <b>ME883S-16/140</b> | <b>ME883SS-16/140</b> |   | 140          |                    | 4.23          | 4.0             |
| Accessories          |                       |   |              |                    |               |                 |
| Part No.             |                       | Description   |              |                    |               |                 |
| Steel                | CF8M Stainless Steel  |   |              |                    |               |                 |
| MEP873               | —                     | 4 Bolt Type A Flange Valve Installation Tool w/ 1" Square Drive |              |                    |               |                 |
| MEP183-102           | —                     | Replacement Torque Posts  |              |                    |               |                 |
| ME842-16-107         | ME842SS-16-107        | 2" FNPT Tapped 4 Bolt Type B Flat Face Flange Adapter           |              |                    |               |                 |
| ME843-16-107         | ME843SS-16-107        | 2" Socket Weld 4 Bolt Type B Flat Face Flange Adapter           |              |                    |               |                 |

**WARNING** - Reducing outlet pipe size below nominal inlet diameter could result in excess flow feature failing to close as designed

Liquid Butane Capacity = Flow Rate x .94

Liquid Anhydrous Ammonia Capacity = Flow Rate x .90

**MEP873**

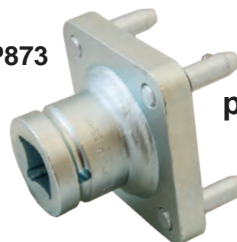

**Throw away that pipe wrench for GOOD!**



# EXCESS FLOW VALVES

MEC offers the largest closing flow selection in the industry. These excess flow valves are intended for use in liquid or vapor LP-Gas or NH<sub>3</sub> systems. These valves can be used for filling, withdrawal and vapor equalization in containers or line applications, specifically long lines or branch piping. This product is designed to protect against excessive discharge as a result of a break in the hose or piping system. The excess flow feature is designed to remain closed after activation until the system pressure equalizes on both sides of the shutoff poppet.

NOTE: Intended for direct installation into pressure vessels and/or piping.

WARNING: An excess flow valve will not activate if there is a break or leak downstream of the valve that does not equal or exceed the closing flow of the valve or if the excess flow valve installed exceeds the flow capacity of the system. See the Excess Flow Warning page for more information regarding the use of excess flow devices.

## FEATURES

- All stainless steel internal components
- Integral breakaway feature leaves valve assembly intact with internal hex broach for easy removal



ME880 Series



TRUCK & PLANT EQUIPMENT

ME880S Series



ME882S Series



| Part No.     |               |                  | Inlet MNPT | Outlet FNPT     | Closing Flow GPM Propane |
|--------------|---------------|------------------|------------|-----------------|--------------------------|
| Brass        | Steel*        | Stainless Steel* |            |                 |                          |
| ME880-4/1.8  | —             | —                | 1/4"       | 1/4"            | 1.8                      |
| ME880-6/4.6  | ME880S-6/4.6  | ME880SS-6/4.6    | 3/4"       | 3/4"            | 4.6                      |
| ME880-6/14   | ME880S-6/14   | ME880SS-6/14     | 3/4"       | 3/4"            | 14                       |
| ME880-6/17   | ME880S-6/17   | ME880SS-6/17     | 3/4"       | 3/4"            | 17                       |
| ME880-6/22   | ME880S-6/22   | ME880SS-6/22     | 3/4"       | 3/4"            | 22                       |
| ME880-6/28   | ME880S-6/28   | ME880SS-6/28     | 3/4"       | 3/4"            | 28                       |
| ME880-10/32  | ME880S-10/32  | ME880SS-10/32    | 1-1/4"     | 1-1/4"          | 32                       |
| ME880-10/42  | ME880S-10/42  | ME880SS-10/42    | 1-1/4"     | 1-1/4"          | 42                       |
| ME880-12/95  | —             | —                | 1-1/2"     | 1-1/2"          | 95                       |
| ME880-16/80  | ME880S-16/80  | ME880SS-16/80    | 2"         | 2"              | 80                       |
| ME880-16/105 | ME880S-16/105 | ME880SS-16/105   | 2"         | 2"              | 105                      |
| ME880-16/114 | ME880S-16/114 | ME880SS-16/114   | 2"         | 2"              | 114                      |
| ME880-16/140 | ME880S-16/140 | ME880SS-16/140   | 2"         | 2"              | 140                      |
| —            | ME882S-16/80  | —                | 2"         | 2" MNPT         | 80                       |
| —            | ME882S-16/105 | —                | 2"         | 2" MNPT         | 105                      |
| —            | ME882S-16/114 | —                | 2"         | 2" MNPT         | 114                      |
| —            | ME882S-16/140 | —                | 2"         | 2" MNPT         | 140                      |
| —            | ME880S-24/265 | —                | 3"         | 3"              | 265                      |
| —            | ME880S-24/350 | —                | 3"         | 3"              | 350                      |
| —            | ME882S-24/265 | —                | 3"         | 3" MNPT/2" FNPT | 265                      |
| —            | ME882S-24/350 | —                | 3"         | 3" MNPT/2" FNPT | 350                      |

**WARNING** - Reducing outlet pipe size below nominal inlet diameter could result in excess flow feature failing to close as designed

Liquid Butane Capacity = Flow Rate x .94

Liquid Anhydrous Ammonia Capacity = Flow Rate x .90



## 2", 3" & 4" FULL INTERNAL FOR FLANGE MOUNTING IN CONTAINER SERVICE

Full internal excess flow valves are designed for service applications where the tank flange is constructed with internal NPT threads and not configured to accept an internal valve assembly. These valves can be utilized for liquid filling, withdrawal applications as well as vapor equalization. The high flow rate design ensures maximum transfer efficiency while minimizing pump cavitation.

If vapor riser piping is utilized in conjunction with these full internal excess flow valves to direct flow into the vessel vapor space, the riser pipe diameter must be a minimum of two times the valve thread connection size to ensure no restriction in flow through the side openings on the excess flow valve.

The full internal flange mounted configuration allows for easy serviceability by dropping the flange connection while completely enclosing the excess flow device within the flange for enhanced protection during a fire event. The full internal configuration also ensures that no piping loads or stresses are imposed onto the excess flow device as it is captured between the mating flanges joint.

**ME3500-16 Series**  
2" MNPT



**ME3500-32 Series**  
4" MNPT

**ME3500-24 Series**  
3" MNPT



### FEATURES

- Precision machined
- Generous flow channels provide low pressure drop, minimizing pump cavitation
- Cotter pin design prevent loss of spring retainer due to vibration in service
- All stainless steel construction

| Part No.      | Inlet Flange (NPT) | Effective Thread (Approx.) | Liquid Propane Approx. Closing Flow (GPM) | Installation Hex Tool | Tank Opening | Outside Diameter |
|---------------|--------------------|----------------------------|---|-----------------------|--------------|------------------|
| ME3500-16/75  | 2"                 | 3/4"                       | 75  | MEP200FIR             | 3-1/2"       | 6-1/2"           |
| ME3500-16/125 |                    |                            | 125                                       |                       |              |                  |
| ME3500-16/150 |                    |                            | 150                                       |                       |              |                  |
| ME3500-24/150 | 3"                 | 1"                         | 150                                       | MEP300FIR             | 4-1/2"       | 8-1/4"           |
| ME3500-24/200 |                    |                            | 200                                       |                       |              |                  |
| ME3500-24/250 |                    |                            | 250                                       |                       |              |                  |
| ME3500-32/500 | 4"                 | 1-1/16"                    | 500                                       | MEP3500               | 5-1/2"       | 10"              |

# EXCESS FLOW VALVES

## 2" & 3" MNPT x MNPT - FOR CONTAINER SERVICE APPLICATIONS

Full internal/in-line excess flow valves are designed for container service applications where the tank is constructed with threaded full or half couplings. These valves can be utilized for liquid filling, withdrawal applications as well as vapor equalization. The high flow rate design ensures maximum transfer efficiency while minimizing pump cavitation.

If vapor riser piping is utilized in conjunction with these full internal excess flow valves to direct flow into the vessel vapor space, the riser pipe diameter must be a minimum of two times the valve thread connection size to ensure no restriction in flow through the side openings on the excess flow valve.



### FEATURES

- All CF8M stainless steel construction
- Precision machined
- Generous flow channels provide low pressure drop, minimizing pump cavitation
- Cotter pin design prevent loss of spring retainer due to vibration in service

| Part No.      | Inlet Connection (MNPT) | Outlet Connection (NPT) | Wrench Flats | Liquid Propane Approx. Closing Flow (GPM) |
|---------------|-------------------------|-------------------------|--------------|---|
| ME3600-16/75  | 2" MNPT                 | 2" MNPT & 1-1/4" FNPT   | 2.50" Hex    | 75  |
| ME3600-16/125 |                         |                         |              | 125                                       |
| ME3600-16/150 |                         |                         |              | 150                                       |
| ME3600-24/150 | 3" MNPT                 | 3" MNPT & 2" FNPT       | 3.75" Hex    | 150                                       |
| ME3600-24/200 |                         |                         |              | 200                                       |
| ME3600-24/250 |                         |                         |              | 250                                       |



# EXCELA-FLANGE™ HIGH FLOW BACK CHECK VALVES

The ME873S Series valves feature our new modular **Excelsa-Flange™** 4 bolt inlet flange design that can be easily adapted to both NPT thread or socket weld type B companion flanges ranging from 1-1/4" to 2" in diameter making it universal to piping sizes within this range. This innovative system allows installers the ability to eliminate unnecessary extra connections as well as possible leak points by integrating a convenient 4 bolt flange union at the valve inlet. Marshall Excelsior High Flow back check valves provide back flow protection to container openings or liquid lines where flow is intended for one direction. The valve is normally held closed until pressure activates the valve when flow is directed into piping or containers causing the back check to open. When flow stops or reverses, the check returns to the closed position. All MEC High Flow Back Check valves are supplied with o-ring soft seats, which can be removed for metal to metal seating. Also available with permanently bonded on main valve seals (SBN).



ME873S-24



ME873SBN-24  
(SBN - BONDED SEAT)



ME873SS-16

## FEATURES

- Universal seat - Remove O-ring seal to create metal to metal seating surface or (SBN) bonded seat
- Up to **20% MORE FLOW** than nearest competitor
- Maximum product flow achieved by full port and stem travel design
- All models feature stainless steel stem, spring and valve guide
- Valve body: Ductile Iron / Shutoff poppet assy: steel & stainless steel
- Available in 1-1/4" NPT, 2" NPT and 3" NPT x 4 Bolt Type A Flange
- All models can be used with LP Gas or NH<sub>3</sub>
- Universal 4 bolt flange inlet type A
- **All models now available with CF8M Stainless Steel body & bonnet**

| Part No. *   |                      | Description  | Propane Flow @ 10 PSIG Pressure Differential | Mating Flange Type | Weight (lbs.) |                 |
|--------------|----------------------|--|--|--------------------|---------------|-----------------|
| Ductile Iron | CF8M Stainless Steel |  |  |                    | Standard      | Stainless Steel |
| ME873S-10    | ME873SS-10           | 1-1/4" MNPT x 4 Bolt Type A Flange BCV                   | 61   | B                  | 4.1           | 3.5             |
| ME873SBN-10  | ME873SSBN-10         | 1-1/4" MNPT x 4 Bolt Type A Flange BCV (SBN) Bonded Seat |  |                    |               |                 |
| ME873S-16    | ME873SS-16           | 2" MNPT x 4 Bolt Type A Flange BCV                       | 187  | B                  | 4.2           | 4.0             |
| ME873SBN-16  | ME873SSBN-16         | 2" MNPT x 4 Bolt Type A Flange BCV (SBN) Bonded Seat     |  |                    |               |                 |
| ME873S-24    | ME873SS-24           | 3" MNPT x 4 Bolt Type A Flange BCV                       | 449  | B                  | 7.0           | 7.0             |
| ME873SBN-24  | ME873SSBN-24         | 3" MNPT x 4 Bolt Type A Flange BCV (SBN) Bonded Seat     |  |                    | 7.1           |                 |

\* Replacements o-rings available upon request. See Replacement Parts section.

NOTE: Liquid Butane Capacity = Flow Rate x .94

Liquid Anhydrous Ammonia Capacity = Flow Rate x .90



# HIGH FLOW BACK CHECK VALVES

These back check flow valves lead the industry with up to **20% More Flow** than the nearest competitor. Back check valves provide flow protection to container openings or liquid lines where flow is intended for one direction. The valve is normally closed until pressure activates the valve when flow is directed into piping or containers causing the back check to open. When flow stops or reverses, the check returns to the closed position.

These valves come with dual seating capabilities or an optional bonded soft seat on 2 and 3" models. With the dual seating capabilities, the factory installed O-ring provides a leak-free, soft seat seal which enables repair and maintenance to be done on depressurized plumbing. Remove the O-ring to allow metal-to-metal seating with a minimal leak seal to restrict flow in case of a break in the line.

NOTE: Leaving the O-ring soft seat installed on the valve will require a minimum of 15 psig pressure differential between the transfer line and container to unseat the valve and allow it to fully open.

## FEATURES

- Up to **20% More Flow** than nearest competitor
- Maximum flow achieved by full port and increased stem travel design
- Integral breakaway feature leaves valve assembly intact with internal hex broach for easy removal
- All stainless steel internal components
- Dual purpose seat reduces inventory from 2 to 1



**ME870 Series**  
Shown with  
O-Ring Soft Seat



**ME870S Series**  
Shown with O-Ring  
Removed for  
Metal-to-Metal Seat



**ME872S-16**



**ME870SBN-24**  
Shown with Bonded  
Soft Seat

| High Flow Back Check Valves |                      |                     |                  |                |  |
|-----------------------------|----------------------|---------------------|------------------|----------------|--|
| Part No.                    |                      |                     | Inlet<br>FNPT    | Outlet<br>MNPT | Propane Flow<br>at 10 PSIG<br>Pressure<br>Differential |
| Brass                       | Steel*               | Stainless<br>Steel* |                  |                |  |
| <b>ME870-6</b>              | <b>ME870S-6</b>      | <b>ME870SS-6</b>    | 3/4"             | 3/4"           | 24   |
| <b>ME870-10</b>             | <b>ME870S-10</b>     | <b>ME870SS-10</b>   | 1-1/4"           | 1-1/4"         | 61   |
| <b>ME870-12</b>             | —                    | —                   | 1-1/2"           | 1/2"           | 112  |
| <b>ME870-16</b>             | <b>ME870S-16</b>     | <b>ME870SS-16</b>   | 2"               | 2"             | 187  |
| —                           | <b>ME872S-16</b>     | —                   | 2" MNPT          | 2"             | 187  |
| —                           | <b>ME870S-24</b>     | —                   | 3"               | 3"             | 449  |
| —                           | <b>ME872S-24</b>     | —                   | 2" FNPT/ 3" MNPT | 3"             | 449  |
| —                           | <b>ME872S-24SP**</b> | —                   | 2" FNPT          | 3"             | 449  |

\* Rated for LP-Gas & NH<sub>3</sub>  
\*\* Includes removable o-ring

| High Flow Back Check Valves w/ Bonded Soft Seat |                      |                     |                  |                |  |
|---|----------------------|---------------------|------------------|----------------|--|
| Part No.  |                      |                     | Inlet<br>FNPT    | Outlet<br>MNPT | Propane Flow<br>at 10 PSIG<br>Pressure<br>Differential |
| Brass   | Steel*               | Stainless<br>Steel* |                  |                |  |
| —   | <b>ME870SBN-10</b>   | —                   | 1-1/4"           | 1-1/4"         | 61   |
| —   | <b>ME870SBN-16</b>   | —                   | 2"               | 2"             | 187  |
| —   | <b>ME872SBN-16</b>   | —                   | 2" MNPT          | 2"             | 187  |
| —   | <b>ME870SBN-24**</b> | —                   | 3"               | 3"             | 449  |
| —   | <b>ME872SBN-24</b>   | —                   | 2" FNPT/ 3" MNPT | 3"             | 449  |
| —   | <b>ME872SBN-24SP</b> | —                   | 2" FNPT          | 3"             | 449  |

\* Rated for LP-Gas & NH<sub>3</sub>  
\*\* Use for high flow transport applications

Liquid Butane Capacity = Flow Rate x .94  
Liquid Anhydrous Ammonia Capacity = Flow Rate x .90



# BACK PRESSURE CHECK VALVES

## 2" & 3" FULL INTERNAL FOR FLANGED INSTALLATION

Full internal back check valves are designed for liquid filling service applications where the tank flange is constructed with internal NPT threads and not configured to accept a traditional threaded back check valve assembly. The high flow rate design ensures maximum transfer efficiency while minimizing pump cavitation.

If vapor riser piping (Spray fill) is utilized in conjunction with these full internal back check valves to direct flow into the vessel vapor space, the riser pipe diameter must be a minimum of two times the valve thread connection size to ensure no restriction in flow through the side openings on the back check valve.

The full internal flange mounted configuration allows for easy serviceability by dropping the flange connection while completely enclosing the back check device within the flange for enhanced protection during a fire event. The full internal configuration also ensures that no piping loads or stresses are imposed onto the back check device as it is captured between the mating flanges joint.



**ME3400-16**  
2" MNPT



**ME3400-24**  
3" MNPT

### FEATURES

- Precision machined
- Generous flow channels provide low pressure drop, minimizing pump cavitation
- All CF8M stainless steel construction ensures long service life
- Speeds up filling operations in bulk plant operations

| Part No.         | Flange Connection (MNPT) | Liquid Propane Flow Differential Pressure (GPM) |         | Overall Length | Threaded End to Port | Installation Hex Tool | Weight (lbs) |
|------------------|--------------------------|---|---------|----------------|----------------------|-----------------------|--------------|
|                  |                          | 5 PSIG  | 10 PSIG |                |                      |                       |              |
| <b>ME3400-16</b> | 2"                       | 224   | 326     | 5-1/8"         | 1-3/4"               | MEP200FIR             | 1.8          |
| <b>ME3400-24</b> | 3"                       | 460   | 650     | 5-1/2"         | 1-13/32"             | MEP300FIR             | 3.6          |



# EXCELA-FLANGE™ HIGH FLOW BACK CHECK VALVES

## SOCKET WELD STYLE

These **Excelsa-Flange™** High Flow Socket Weld Back Check valves lead the industry with up to **20% More Flow** than the nearest competitor. Back check valves provide flow protection to container openings or liquid lines where flow is intended for one direction. The valve is normally closed until pressure activates the valve when flow is directed into piping or containers causing the back check to open. When flow stops or reverses, the check returns to the closed position.

Featuring socket weld connection points, these valves are ideally suited for inline applications where welded piping construction is desired, such as in a bobtail spray fill / bypass return combination line. A perfect companion to the MEC **Excelsa-Flange™** product line. Only available with metal-to-metal seat due to high heat associated with socket weld construction/installation.

### FEATURES

- Up to 20% More Flow than nearest competitor
- Maximum flow achieved by full port and increased stem travel design
- Integral breakaway feature leaves valve assembly intact
- All stainless steel internal components
- High temperature Inconel spring withstands heat from welding



ME870SW-16



| Part No.          |                      | Inlet Socket Weld | Outlet Socket Weld | Propane Flow @ 10 PSIG Pressure Differential | Weight (lbs.) |
|-------------------|----------------------|-------------------|--------------------|--|---------------|
| WCC A216 Steel    | CF8M Stainless Steel |                   |                    |  |               |
| <b>ME870SW-16</b> | <b>ME870SSW-16</b>   | 2" Female         | 2" Male            | 189  | 1.77          |

NOTE: Rated for LP-Gas & NH<sub>3</sub>

Liquid Butane Capacity = Flow Rate x .94

Liquid Anhydrous Ammonia Capacity = Flow Rate x .90

## WELDABLE NPT SWIVEL CONNECTOR JOINTS

The ME691 and ME693 series weldable NPT swivel joints are intended for use anywhere that welded piping is desired but NPT threaded flex lines must be installed to protect against vibration and/or fixed piping metal fatigue. The weld end features a unique butt weld/socket weld end that is universal for either connection type. The NPT end features a crimped female swivel with a tapered internal seat ideal for sealing on all standard male NPT flex line connectors. These connectors are ideal for both mobile and stationary applications such as pump inlet/outlet, meter inlet, or hose reel inlet piping transitions.

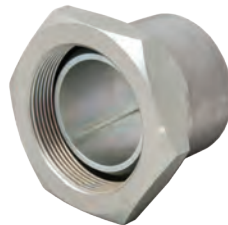

ME691-12

ME691-16



ME693-16/12

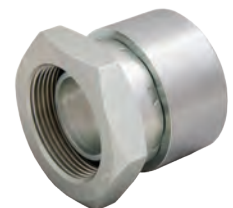

### FEATURES

- Compact high grade plated steel construction
- Universal butt weld/socket weld end connection
- Universal tapered FNPT seat design
- Ready to weld without surface preparation
- Rated 400 WOG for LPG & NH<sub>3</sub> applications

| Part No.           |                      | Description            | Butt/Socket Weld | FNPT Swivel |
|--------------------|----------------------|------------------------|------------------|-------------|
| WCC A216 Steel     | CF8M Stainless Steel |                        |                  |             |
| <b>ME691-12</b>    | <b>ME691SS-12</b>    | Swivel Connector Joint | 1-1/2"           | 1-1/2"      |
| <b>ME693-16/12</b> | <b>ME693SS-16/12</b> |                        | 2"               | 1-1/2"      |
| <b>ME691-16</b>    | <b>ME691SS-16</b>    |                        | 2"               | 2"          |



# HIGH FLOW DOUBLE BACK CHECK FILL VALVES

MEC High Flow Double Back Check Valves provide back flow protection to container openings or liquid lines where flow is intended in one direction. The valve is normally held closed until pressure activates the valve when flow is directed into piping or containers causing the double back check to open. When flow stops or reverses, both checks return to the closed position. All MEC High Flow Double Back Check Valves are supplied with the correct ACME cap and chain assembly, as well as factory installed hydrostatic relief protection.

## FEATURES

- Primary Seat - Creates metal to metal seating surface
- Secondary Seat - bonded nitrile soft seat for a leak free seal
- Up to **20% More Flow** than nearest competitor
- Maximum product flow achieved by full port and stem travel design
- All models feature stainless steel stem, spring and valve guide in body check assembly
- Built in hydrostatic relief valve
- For use with **LP Gas ONLY**

ME869-10/8

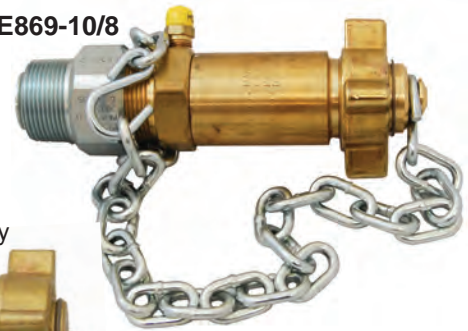

ME869-24



| Part No.    | Description  | Propane Flow          |        |        |
|-------------|--|-----------------------|--------|--------|
|             |  | Differential Pressure |        |        |
|             |  | 10 PSI                | 25 PSI | 50 PSI |
| ME869-10/10 | Double Back Check Valve 1-1/4" MNPT x 2-1/4" M. Acme | 75                    | 116    | 157    |
| ME869-16    | Double Back Check Valve 2" MNPT x 3-1/4" M. Acme     | 195                   | 296    | 416    |
| ME869-24    | Double Back Check Valve 3" MNPT x 3-1/4" M. Acme     | 347                   | 519    | 718    |

# HIGH FLOW SINGLE & DOUBLE BACK CHECK FILL VALVES

MEC high flow single & double back check fill valves provide back flow protection to container openings or liquid lines where flow is intended in one direction. The valve is normally held closed until pressure activates the valve when flow is directed into piping or containers causing the back check to open. When flow stops or reverses, the check returns to the closed position. All MEC High Flow Back Check Valves are supplied with the correct ACME cap and chain assembly.

## FEATURES

- Double check primary seat creates metal to metal seating surface
- Double check secondary seat is a soft seat for a leak free seal
- Up to **30% MORE FLOW** than nearest competitor
- Maximum product flow achieved by full port and maximum stem travel design
- All models feature a brass stem, stainless steel spring and bronze valve guide in body check assembly
- For use with **LP Gas Only**



ME3197C



ME3194C

| Part No. | Description   | Differential Flow GPM/ LPG @ 10 PSI |
|----------|---|-------------------------------------|
| ME3194C  | Single Back Check Fill Valve 3-1/4" M. Acme x 3" MNPT | 365                                 |
| ME3197C  | Double Back Check Fill Valve 3-1/4" M. Acme x 3" MNPT | 285                                 |

NOTE: For use with LPG only



# EXCELERATOR™ 1-1/4" INTERNAL COMBINATION VALVE

The **ME1000 Series Internal Combination Valve** is uniquely designed to incorporate the full functionality of the primary internal control valve and excess flow protection, followed by a fully integrated positive shut-off downstream valve section, plus incorporation of the stainless steel filter element section of a traditional Y-Strainer, all packed neatly into one compact unit. This all leads to a combination construction with reduced connection joints, leak points and overall weight, perfectly suited for liquid or vapor withdrawal in LPG dispenser and NH<sub>3</sub> nurse tank applications along with emergency liquid withdrawal on stationary and mobile tanks, among many other applications for this universal valve series. The ME1000 series features a range of excess flow closing springs and the universal tee body design ships complete with the bottom port factory plugged, allowing for plumbing configurations in tight clearance areas.

The ME1000 Series is also designed to utilize the standard ME990 Series internal valve packing glands for ease of serviceability.

## FEATURES

- Durable 316 CF8M stainless steel cast body
- All stainless internal component construction
- 1-1/4" MNPT internal valve inlet connection with 2 outlets
- 1/4" NPT plugged auxiliary port
- Standard 40 mesh strainer screen factory installed
- Large variety of excess flow closing values
- Factory installed plug (bottom outlet)
- Industry's fastest bleed time
- Removable data plate
- Less weight (9.6 lbs vs. approximately 20 lbs)
- Fewer leak points
- Standard construction utilizes Nitrile seals
- Also available with FKM seals
-  LISTED for LPG & NH<sub>3</sub> service
- Rulon™ bearing on stub shaft
- Integrated shutoff valve pilot feature



Outlet #1

Outlet #2

| Part No. *        | Inlet       | Outlet #1   | Outlet #2   | Optional Liquid Closing Flow Values** | Latch/ Actuator Type | Accessories                                 |   |
|-------------------|-------------|-------------|-------------|---------------------------------------|----------------------|---|---|
| ME1000-10-A/"X"   | 1-1/4" MNPT | 1" FNPT     | 1" FNPT     | "X"<br>40 GPM<br>55 GPM<br>70 GPM     | —                    | ME1000F-101-20<br>20 mesh strainer screen   |   |
| ME1000A-10-A/"X"  |             |             |             |                                       | Pneumatic            |   |   |
| ME1000AR-10-A/"X" |             |             |             |                                       | Rotary               |   |   |
| ME1000M-10-A/"X"  |             |             |             |                                       | Manual Latch         |   |   |
| ME1000-10-B/"X"   |             | 1" FNPT     | 1-1/4" FNPT | "X"<br>40 GPM<br>55 GPM<br>70 GPM     | —                    |   | ME1000F-101-80<br>80 mesh strainer screen                                   |
| ME1000A-10-B/"X"  |             |             |             |                                       | Pneumatic            |   |   |
| ME1000AR-10-A/"X" |             |             |             |                                       | Rotary               |   |   |
| ME1000M-10-B/"X"  |             |             |             |                                       | Manual Latch         |   |   |
| ME1000-10-C/"X"   |             | 1-1/4" FNPT | 1" FNPT     | "X"<br>45 GPM<br>55 GPM<br>85 GPM     | —                    | ME1000F-101-100<br>100 mesh strainer screen |   |
| ME1000A-10-C/"X"  |             |             |             |                                       | Pneumatic            |   |   |
| ME1000AR-10-C/"X" |             |             |             |                                       | Rotary               |   |   |
| ME1000M-10-C/"X"  |             |             |             |                                       | Manual Latch         |   |   |
| ME1000-10-D/"X"   |             | 1-1/4" FNPT | 1-1/4" FNPT | "X"<br>45 GPM<br>55 GPM<br>85 GPM     | —                    |   | NOTE:<br>40 mesh replacement also available - see replacement parts section |
| ME1000A-10-D/"X"  |             |             |             |                                       | Pneumatic            |   |   |
| ME1000AR-10-D/"X" |             |             |             |                                       | Rotary               |   |   |
| ME1000M-10-D/"X"  |             |             |             |                                       | Manual Latch         |   |   |

\* Indicate desired excess flow closing value when ordering - see chart for values - i.e. ME1000-10-A/55 (55 GPM)  
To order FKM add "V" after the prefix part number i.e. ME1000V-10-A/85

\*\* For NH<sub>3</sub> multiply GPM by .90



# EXCELERATOR™ INTERNAL VALVES

## 1-1/4" THREADED

Intended for use on bobtail trucks and storage tanks with 1-1/4" threaded connections in directional or bi-directional flow applications. Provides both manual shut-down as well as excess flow closing in the event of the piping being separated from the valve. Can be equipped with manual latch, pneumatic or rotary actuator, open/ closing devices. All valve models are equipped with a break-away feature in the cast body which permits the piping to shear off in the event of side impact, leaving the valve poppet intact and protecting the tank from catastrophic product loss.

FOR LIQUID OR VAPOR SERVICE APPLICATIONS.

### FEATURES

- Durable 316 CF8M stainless steel cast body
- All stainless internal component construction
- Hexagonal installation flats to fit standard 2-3/8" hex socket wrench
- Precision machined hard coated stem
- Fully retained Nitrile seat disc
- Large variety of excess flow closing values
- Roller cam actuation
- Industry's fastest bleed time
- Removable data plate
- Industry's easiest valve to service
- Standard construction utilizes Nitrile seals
- Also available with FKM or FFKM seals
-  LISTED for LPG & NH<sub>3</sub> service (ME990-10 SERIES ONLY)
- Rulon™ bearing on stub shaft



ME990-10 Series

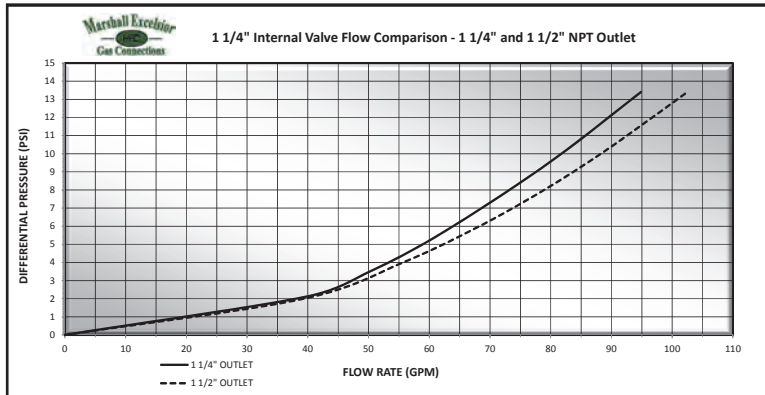

| "X" | 1-1/4" Valve Liquid Closing Flow Values |
|-----|---|
| 35  | 35 GPM LPG Closing Flow                 |
| 55  | 55 GPM LPG Closing Flow                 |
| 85  | 85 GPM LPG Closing Flow                 |

NOTE: For NH<sub>3</sub> multiply GPM by .90

| Part No. *        | Description   |
|-------------------|---|
| ME990-10-"X"      | <i>Excelsior</i> ™ 1-1/4" MNPT x 1-1/4" FNPT Internal Valve                           |
| ME990-10/12-"X"   | <i>Excelsior</i> ™ 1-1/4" MNPT x 1-1/2" FNPT Internal Valve                           |
| ME990A-10-"X"     | <i>Excelsior</i> ™ 1-1/4" MNPT x 1-1/4" FNPT Internal Valve - with Pnuematic Actuator |
| ME990A-10/12-"X"  | <i>Excelsior</i> ™ 1-1/4" MNPT x 1-1/2" FNPT Internal Valve - with Pnuematic Actuator |
| ME990AR-10-"X"    | <i>Excelsior</i> ™ 1-1/4" MNPT x 1-1/4" FNPT Internal Valve - with Rotary Actuator    |
| ME990AR-10/12-"X" | <i>Excelsior</i> ™ 1-1/4" MNPT x 1-1/2" FNPT Internal Valve - with Rotary Actuator    |
| ME990M-10-"X"     | <i>Excelsior</i> ™ 1-1/4" MNPT x 1-1/4" FNPT Internal Valve - with Manual Latch       |
| ME990M-10/12-"X"  | <i>Excelsior</i> ™ 1-1/4" MNPT x 1-1/2" FNPT Internal Valve - with Manual Latch       |

\* Indicate desired excess flow closing value when ordering - see chart for values - i.e. ME990-10-85 (85 GPM)  
 To order FFKM add "K" after the prefix part number i.e. ME990K-10-85  
 To order FKM add "V" after the prefix part number i.e. ME990V-10-85



# EXCELA-FLANGE™ INTERNAL VALVES

## 1-1/4" MNPT x 4 BOLT FLANGE

The ME991-10 Series valves feature our new modular **Excelsa-Flange™** 4 bolt outlet flange design that can be easily adapted to both NTP thread or socket weld type B companion flanges (ME842 & ME843 Series) ranging from 1-1/4" to 2" in diameter making it universal to piping sizes within this range. This innovative system allows installers the ability to eliminate unnecessary connections as well as possible leak points by integrating a convenient 4 bolt flange union at the valve outlet. Intended for use on bobtail trucks and storage tanks with 1-1/4" threaded connections in directional or bi-directional flow applications. Provides both manual shut-down as well as excess flow closing in the event of the piping being separated from the valve. Can be equipped with manual latch, pneumatic or rotary actuator, open/ closing devices. All valve models are equipped with a break-away feature in the cast body which permits the piping to shear off in the event of side impact, leaving the valve poppet intact and protecting the tank from catastrophic product loss. FOR LIQUID OR VAPOR SERVICE APPLICATIONS.

NOTE: See pages 108-110 for flanged deminsions and installation torque values.

### FEATURES

- Durable 316 CF8M stainless steel cast body
- All stainless internal component construction
- Precision machined hard coated stem
- Fully retained nitrile seat disc
- Large variety of excess flow closing values
- Roller cam actuation
- Industry's fastest bleed time
- Removable data plate
- Industry's easiest valve to service
- Standard construction utilizes nitrile seals
- Also available with FKM or FFKM seals
-  LISTED for LPG & NH<sub>3</sub> service
- Rulon™ bearing on stub shaft
- 4 Bolt universal outlet flange for built in union joint



**ME991-10 Series**  
1-1/4" MNPT x 4 Bolt Type A  
Flanged Internal Valve

| "X" | 1-1/4" Valve Liquid Closing Flow Values |
|-----|---|
| 35  | 35 GPM LPG Closing Flow                 |
| 55  | 55 GPM LPG Closing Flow                 |
| 85  | 85 GPM LPG Closing Flow                 |

NOTE: For NH<sub>3</sub> multiply GPM by .90

| Part No. *     | Description   | Mating Flange Type | Weight (lbs.) |
|----------------|---|--------------------|---------------|
| ME991-10-"X"   | <b>Excelsa-Flange™</b> 1-1/4" MNPT x 4 Bolt Type A Flange Internal Valve - Only                 | B                  | 5.7           |
| ME991A-10-"X"  | <b>Excelsa-Flange™</b> 1-1/4" MNPT x 4 Bolt Type A Flange Internal Valve - w/Pneumatic Actuator | B                  | 9.5           |
| ME991AR-10-"X" | <b>Excelsa-Flange™</b> 1-1/4" MNPT x 4 Bolt Type A Flange Internal Valve - w/Rotary Actuator    | B                  | 10.2          |
| ME991M-10-"X"  | <b>Excelsa-Flange™</b> 1-1/4" MNPT x 4 Bolt Type A Flange Internal Valve - w/Manual Latch       | B                  | 5.7           |

\* Indicate desired excess flow closing value when ordering - see chart for values - i.e. ME991-10-85 (85 GPM)  
To order FFKM add "K" for after the prefix part number i.e. ME991K-10-35  
To order FKM add "V" after the prefix part number i.e. ME991V-10-35

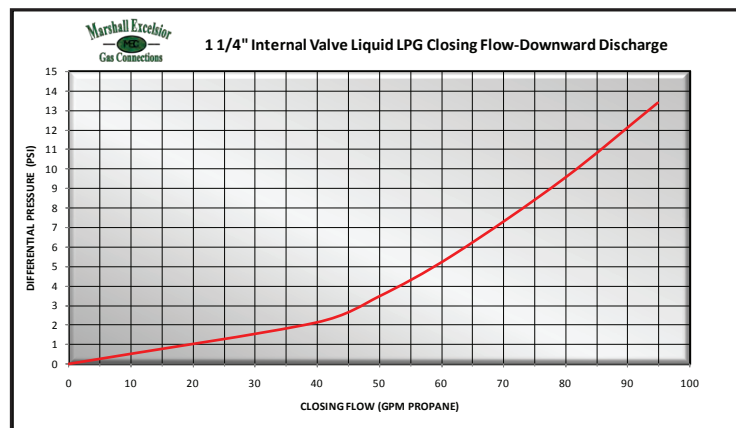

# EXCELERATOR™ INTERNAL VALVES

## 1-1/4" THREADED TEE BODY

Intended for use on bobtail trucks and storage tanks with 1-1/4" threaded connections in directional or bi-directional flow applications. Provides both manual shut-down as well as excess flow closing in the event of the piping being separated from the valve. Can be equipped with manual latch, pneumatic or rotary actuator, open/ closing devices. All valve models are equipped with a break-away feature in the cast body which permits the piping to shear off in the event of side impact, leaving the valve poppet intact and protecting the tank from catastrophic product loss. The tee body features an additional FNPT side discharge port .

FOR LIQUID OR VAPOR SERVICE APPLICATIONS.

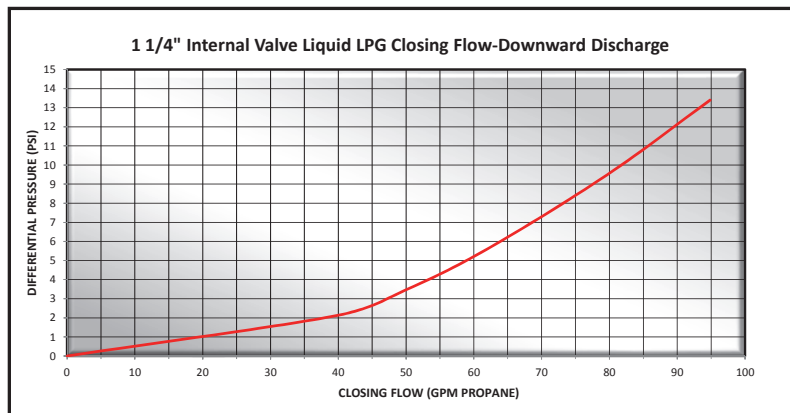

**ME992-10 Series**  
1-1/4" NTP Tee Body Internal Valve

### FEATURES

- Durable 316 CF8M stainless steel cast body
- All stainless internal component construction
- Precision machined hard coated stem
- Fully retained nitrile seat disc
- Large variety of excess flow closing values
- Roller cam actuation
- Industry's fastest bleed time
- Removable data plate
- Industry's easiest valve to service
- Standard construction utilizes nitrile seals
- Available with Neoprene, FKM, or FFKM seals
- LISTED for LPG & NH<sub>3</sub> service
- Rulon™ bearings on stem and stub shafts

| "X" | 1-1/4" Valve Liquid Closing Flow Values |
|-----|---|
| 35  | 35 GPM LPG Closing Flow                 |
| 55  | 55 GPM LPG Closing Flow                 |
| 85  | 85 GPM LPG Closing Flow                 |

NOTE: For NH<sub>3</sub> multiply GPM by .90

| MEC <i>Excelsator</i> ™ 1-1/4" Threaded Tee Body Internal Valves |  |
|--|--|
| Part No. *   | Description  |
| ME992-10-"X"   | <i>Excelsator</i> ™ 1-1/4" MNPT x 1-1/4" FNPT Internal Valve - Only                    |
| ME992A-10-"X"  | <i>Excelsator</i> ™ 1-1/4" MNPT x 1-1/4" FNPT Internal Valve - with Pneumatic Actuator |
| ME992AR-10-"X"   | <i>Excelsator</i> ™ 1-1/4" MNPT x 1-1/4" FNPT Internal Valve - with Rotary Actuator    |
| ME992M-10-"X"  | <i>Excelsator</i> ™ 1-1/4" MNPT x 1-1/4" FNPT Internal Valve - with Manual Latch       |

\* Indicate desired excess flow closing value when ordering - see chart for values- i.e. ME992-10-85 (85 GPM)  
To order FFKM add "K" after the prefix part number i.e. ME992K-10-85  
To order Neoprene add "N" for Neoprene after the prefix part number i.e. ME992N-10-85  
To order FKM add "V" after the prefix part number i.e. ME992V-10-85



# EXCELERATOR™ INTERNAL VALVES

## 1-1/2" THREADED TEE BODY

Intended for use on bobtail trucks, storage tanks and nurse wagons with 1-1/2" threaded connections in directional or bi-directional flow applications. Provides both manual shut-down as well as excess flow closing in the event of the piping being separated from the valve. Can be equipped with manual latch, pneumatic or rotary actuator, open/ closing devices. All valve models are equipped with a break-away feature in the cast body which permits the piping to shear off in the event of side impact, leaving the valve poppet intact and protecting the tank from catastrophic product loss. The tee body features an additional FNPT side discharge port.

FOR LIQUID OR VAPOR SERVICE APPLICATIONS.

### FEATURES

- Durable ductile iron body
- All stainless internal component construction
- Precision machined hard coated stem
- Fully retained nitrile seat disc
- Large variety of excess flow closing values
- Roller cam actuation
- Industry's fastest bleed time
- Removable data plate
- Industry's easiest valve to service
- Standard construction utilizes nitrile seals
- Also available with FKM or FFKM seals
-  LISTED for LPG & NH<sub>3</sub> service
- Rulon™ bearing on stub shaft
- Supplied with hex socket 1-1/2" port plug for single discharge applications



**ME992-12 Series**

1-1/2" NTP Tee Body Internal Valve

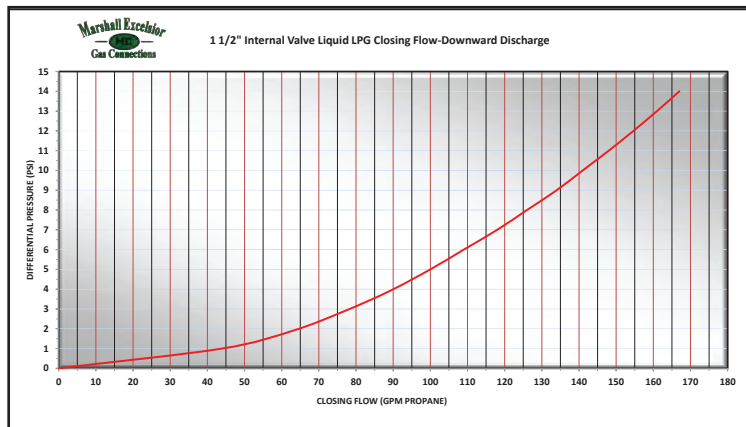

| "X" | 1-1/2" Valve Liquid Closing Flow Values |
|-----|---|
| 50  | 50 GPM LPG Closing Flow                 |
| 65  | 65 GPM LPG Closing Flow                 |
| 85  | 85 GPM LPG Closing Flow                 |
| 110 | 110 GPM LPG Closing Flow                |
| 120 | 125 GPM LPG Closing Flow                |

NOTE: For NH<sub>3</sub> multiply GPM by .90

| Part No. *     | Description  |
|----------------|--|
| ME992-12-"X"   | <b>Excelsior™</b> 1-1/2" MNPT x 1-1/2" FNPT Internal Valve - Only                    |
| ME992A-12-"X"  | <b>Excelsior™</b> 1-1/2" MNPT x 1-1/2" FNPT Internal Valve - with Pneumatic Actuator |
| ME992AR-12-"X" | <b>Excelsior™</b> 1-1/2" MNPT x 1-1/2" FNPT Internal Valve - with Rotary Actuator    |
| ME992M-12-"X"  | <b>Excelsior™</b> 1-1/2" MNPT x 1-1/2" FNPT Internal Valve - with Manual Latch       |

\* Indicate desired excess flow closing value when ordering - see chart for values i.e. ME992-12-85 (85 GPM)  
 To order FFKM add "K" after the prefix part number i.e. ME992K-12-85  
 To order FKM add "V" after the prefix part number i.e. ME992V-12-85



# 2" & 3" THREADED

Intended for use on transport trucks and large storage tanks with 2" or 3" threaded connections in directional or bi-directional flow applications. Provides both manual shut-down and excess flow closing in the event of the piping being separated from the valve. Can be equipped with manual latch, pneumatic or rotary actuator open/ closing devices. All valve models are equipped with a break-away feature in the cast body which permits the piping to shear off in the event of side impact, leaving the valve poppet intact and protecting the tank from catastrophic product loss.  
FOR LIQUID OR VAPOR SERVICE APPLICATIONS

## FEATURES

- Durable ductile body with cadmium surface plating
- All stainless internal component construction
- One piece threaded packing gland
- Precision machined hard coated stem
- Fully retained Nitrile seat disc
- Largest variety of excess flow closing values
- Roller cam actuation
- Industry's fastest bleed time
- Removable data plate
- Industry's easiest valve to service
- Standard construction utilizes Nitrile seals
- Available with PTFE, FKM, or FFKM seals
-  LISTED for LPG & NH<sub>3</sub> service
- Rulon™ bearings on stem and stub shafts



**ME990-16 Series**  
2" NTP Threaded Internal Valve

**ME990-24 Series**  
3" NTP Threaded Internal Valve

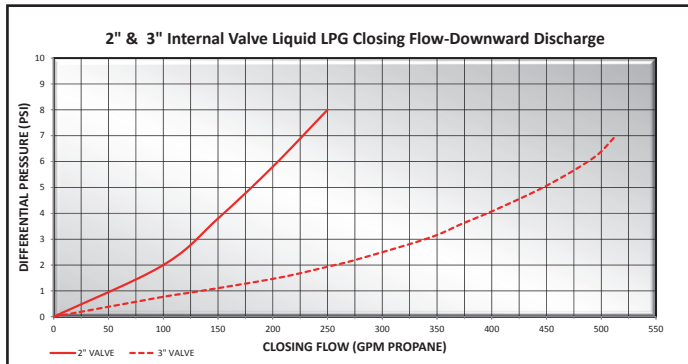

| "X" | 2" Valve Liquid Closing Flow Values |
|-----|-------------------------------------|
| 110 | 110 GPM LPG Closing Flow            |
| 160 | 160 GPM LPG Closing Flow            |
| 260 | 260 GPM LPG Closing Flow            |

| "X" | 3" Valve Liquid Closing Flow Values |
|-----|-------------------------------------|
| 175 | 175 GPM LPG Closing Flow            |
| 250 | 250 GPM LPG Closing Flow            |
| 300 | 300 GPM LPG Closing Flow            |
| 375 | 375 GPM LPG Closing Flow            |
| 400 | 400 GPM LPG Closing Flow            |
| 475 | 475 GPM LPG Closing Flow            |
| 500 | 500 GPM LPG Closing Flow            |

NOTE: For NH<sub>3</sub> multiply GPM by .90

| Part No. *     |                      | Description  | Accessories  |
|----------------|----------------------|--|--------------|
| Ductile Iron   | CF8M Stainless Steel |  | Bell Housing |
| ME990-16-"X"   | ME990SS-16-"X"       | <b>Excelerator™</b> 2" MNPT x 2" FNPT Internal Valve                           | MEP889-16    |
| ME990A-16-"X"  | —                    | <b>Excelerator™</b> 2" MNPT x 2" FNPT Internal Valve - with Pneumatic Actuator |              |
| ME990AR-16-"X" | —                    | <b>Excelerator™</b> 2" MNPT x 2" FNPT Internal Valve - with Rotary Actuator    |              |
| ME990M-16-"X"  | —                    | <b>Excelerator™</b> 2" MNPT x 2" FNPT Internal Valve - with Manual Latch       |              |
| ME990-24-"X"   | ME990SS-24-"X"       | <b>Excelerator™</b> 3" MNPT x 3" FNPT Internal Valve                           | MEP889-24    |
| ME990A-24-"X"  | —                    | <b>Excelerator™</b> 3" MNPT x 3" FNPT Internal Valve - with Pneumatic Actuator |              |
| ME990AR-24-"X" | —                    | <b>Excelerator™</b> 3" MNPT x 3" FNPT Internal Valve - with Rotary Actuator    |              |
| ME990M-24-"X"  | —                    | <b>Excelerator™</b> 3" MNPT x 3" FNPT Internal Valve - with Manual Latch       |              |

\*Note: Indicate desired excess flow closing value when ordering - see chart for values i.e. ME990-24-250 (250 GPM)  
To order PTFE add "T" after the prefix part number i.e. ME990T-24-250  
To order FFKM add "K" after the prefix part number i.e. ME990K-24-250  
To order FKM add "V" after the prefix part number i.e. ME990V-24-250





# EXCELERATOR™ INTERNAL VALVES

## 2" - 300 LB SINGLE AND DOUBLE FLANGED

Intended for use on bobtail delivery trucks, transport trucks and large storage tanks with 2" flanged connections in directional or bi-directional flow applications. Provides both manual shut-down and excess flow closing in the event of the piping being separated from the valve. Can be equipped with manual latch, pneumatic or rotary actuator open/ closing devices. All valve models are equipped with a break-away feature in the cast body which permits the pump or piping to shear off in the event of side impact, leaving the valve poppet intact and protecting the tank from catastrophic product loss.  
FOR LIQUID OR VAPOR SERVICE APPLICATIONS.

NOTE: See pages 108-110 for flanged deminsions and installation torque values.

### FEATURES

- Durable steel body with cadmium surface plating
- All stainless internal component construction
- One piece threaded packing gland
- Precision machined hard coated stem & stem guide
- Fully retained Nitrile seat disc
- Largest variety of excess flow closing values
- Corrosion resistant sleeved flange bolt holes
- Xylan coated corrosion resistant mounting studs
- Roller cam actuation
- Industry's fastest bleed time
- Removable data plate
- Industry's easiest valve to service
- Standard construction utilizes Nitrile seals
- Available with PTFE, FKM, or FFKM seals
- Available with 316 Stainless Steel bodies
- UL LISTED for LPG & NH<sub>3</sub> service
- Rulon™ bearings on stem and stub shafts

**ME990S-2F-16 Series**  
2"-300LB x 2" FNPT



**ME990S-2DFM Series**  
2"-300LB Double  
Flanged Internal Valve

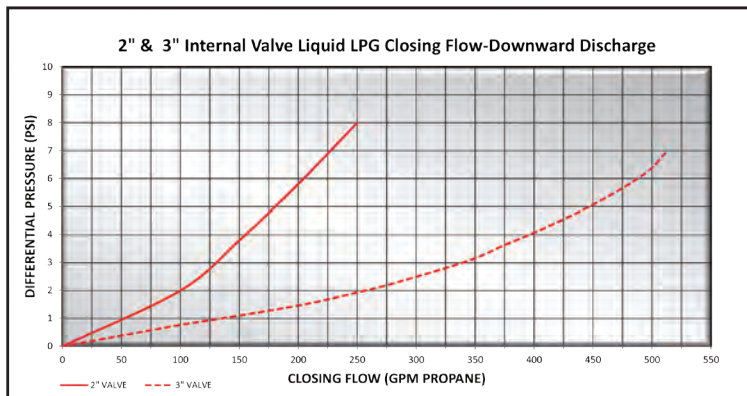

| X   | 2" Valve Liquid Closing Flow Values |
|-----|-------------------------------------|
| 110 | 110 GPM LPG Closing Flow            |
| 160 | 160 GPM LPG Closing Flow            |
| 260 | 260 GPM LPG Closing Flow            |

NOTE: For NH<sub>3</sub> multiply GPM by .90

| Part No. *                |                          | Description  |
|---------------------------|--------------------------|--|
| WCC A216 Steel            | CF8M Stainless Steel     |  |
| <b>ME990S-2F-16-"X"</b>   | <b>ME990SS-2F-16-"X"</b> | 2"-300 lb. Modified Single Flange x 2" FNPT Internal Valve - Only                    |
| <b>ME990SA-2F-16-"X"</b>  | —                        | 2"-300 lb. Modified Single Flange x 2" FNPT Internal Valve - with Pneumatic Actuator |
| <b>ME990SAR-2F-16-"X"</b> | —                        | 2"-300 lb. Modified Single Flange x 2" FNPT Internal Valve - with Rotary Actuator    |
| <b>ME990S-2DFM-"X"</b>    | <b>ME990SS-2DFM-"X"</b>  | 2"-300 lb. Modified Double Flange Internal Valve - Only                              |
| <b>ME990SA-2DFM-"X"</b>   | —                        | 2"-300 lb. Modified Double Flange Internal Valve - with Pneumatic Actuator           |
| <b>ME990SAR-2DFM-"X"</b>  | —                        | 2"-300 lb. Modified Double Flange Internal Valve - with Rotary Actuator              |

\* Indicate desired excess flow closing value when ordering - see chart for values i.e. ME990S-2F-16-260 (260 GPM)

To order PTFE add "T" after the prefix part number i.e. ME990ST-2F-16-260

To order FFKM add "K" after the prefix part number i.e. ME990SK-2F-16-260

To order FKM add "V" after the prefix part number i.e. ME990SV-2F-16-260



# 2" & 3" MNPT x 300 LB FLANGED

Intended for use on transport trucks and large storage tanks with 2" or 3" threaded connections in directional or bi-directional flow applications. The ME991-16 & ME991-24 Series feature standard 300# outlet flanges for fast reliable piping connections downstream of the tank. Ideally suited for existing tanks with NPT threaded couplings but downstream welded piping is desirable. Provides both manual shut-down and excess flow closing in the event of the piping being separated from the valve. Can be equipped with manual latch, pneumatic or rotary actuator open/ closing devices. All valve models are equipped with a break-away feature in the cast body which permits the piping to shear off in the event of side impact, leaving the valve poppet intact and protecting the tank from catastrophic product loss.  
FOR LIQUID OR VAPOR SERVICE APPLICATIONS.

NOTE: See pages 108-110 for flanged deminsions and installation torque values.

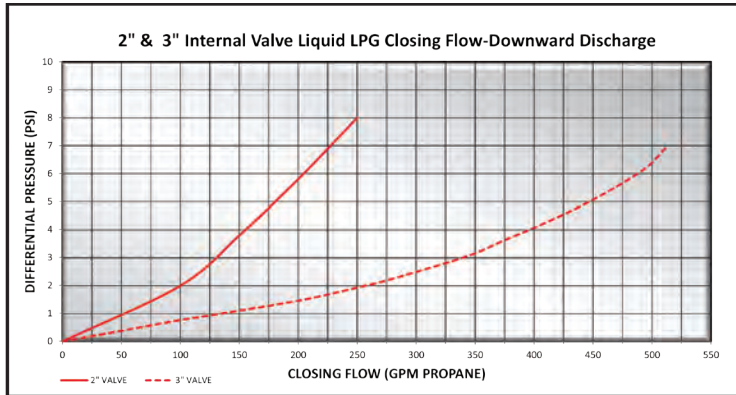

## FEATURES

- Durable ductile body with cadmium surface plating
- All stainless internal component construction
- One piece threaded packing gland
- Precision machined hard coated stem
- Fully retained nitrile seat disc
- Largest variety of excess flow closing values
- Roller cam actuation
- Industry's fastest bleed time
- Removable data plate
- Industry's easiest valve to service
- Standard construction utilizes nitrile seals
- Available with PTFE, FKM, or FFKM seals
- UL LISTED for LPG & NH<sub>3</sub> service
- Rulon™ bearings on stem and stub shafts Rulon™
- Xylan coated corrosion resistant mounting studs & gaskets included

| "X" | 2" Valve Liquid Closing Flow Values |
|-----|-------------------------------------|
| 110 | 110 GPM LPG Closing Flow            |
| 160 | 160 GPM LPG Closing Flow            |
| 260 | 260 GPM LPG Closing Flow            |

| "X" | 3" Valve Liquid Closing Flow Values |
|-----|-------------------------------------|
| 175 | 175 GPM LPG Closing Flow            |
| 250 | 250 GPM LPG Closing Flow            |
| 300 | 300 GPM LPG Closing Flow            |
| 375 | 375 GPM LPG Closing Flow            |
| 475 | 475 GPM LPG Closing Flow            |
| 500 | 500 GPM LPG Closing Flow            |

NOTE: For NH<sub>3</sub> multiply GPM by .90

| Part No. *     |                      | Description   |
|----------------|----------------------|---|
| Ductile Iron   | CF8M Stainless Steel |   |
| ME991-16-"X"   | ME991SS-16-"X"       | <b>Excelsior™</b> 2" MNPT x 2"-300# Flange Internal Valve - Only                    |
| ME991A-16-"X"  | —                    | <b>Excelsior™</b> 2" MNPT x 2"-300# Flange Internal Valve - with Pneumatic Actuator |
| ME991AR-16-"X" | —                    | <b>Excelsior™</b> 2" MNPT x 2"-300# Flange Internal Valve - with Rotary Actuator    |
| ME991M-16-"X"  | —                    | <b>Excelsior™</b> 2" MNPT x 2"-300# Flange Internal Valve - with Manual Latch       |
| ME991-24-"X"   | ME991SS-24-"X"       | <b>Excelsior™</b> 3" MNPT x 3"-300# Flange Internal Valve - Only                    |
| ME991A-24-"X"  | —                    | <b>Excelsior™</b> 3" MNPT x 3"-300# Flange Internal Valve - with Pneumatic Actuator |
| ME991AR-24-"X" | —                    | <b>Excelsior™</b> 3" MNPT x 3"-300# Flange Internal Valve - with Rotary Actuator    |
| ME991M-24-"X"  | —                    | <b>Excelsior™</b> 3" MNPT x 3"-300# Flange Internal Valve - with Manual Latch       |

\* Indicate desired excess flow closing value when ordering - see chart for values - i.e. ME991-24-250 (250 GPM)  
 To order PTFE add "T" after the prefix part number i.e. ME991T-16-260  
 To order FFKM add "K" after the prefix part number i.e. ME991K-16-260  
 To order FKM add "V" after the prefix part number i.e. ME991V-16-260



# EXCELERATOR™ INTERNAL VALVES

## 2" & 3" THREADED TEE BODY

Intended for use on transport trucks and large storage tanks with 2" or 3" threaded connections in directional or bi-directional flow applications. Provides both manual shut-down and excess flow closing in the event of the piping being separated from the valve. Can be equipped with manual latch, pneumatic or rotary actuator open/ closing devices. All valve models are equipped with a break-away feature in the cast body which permits the piping to shear off in the event of side impact, leaving the valve poppet intact and protecting the tank from catastrophic product loss. The tee body features an additional FNPT side discharge port.

FOR LIQUID OR VAPOR SERVICE APPLICATIONS.

### FEATURES

- Durable ductile body with cadmium surface plating
- All stainless internal component construction
- One piece threaded packing gland
- Precision machined hard coated stem
- Fully retained nitrile seat disc
- Largest variety of excess flow closing values
- Roller cam actuation
- Industry's fastest bleed time
- Removable data plate
- Industry's easiest valve to service
- Standard construction utilizes nitrile seals
- Available with PTFE, FKM, or FFKM seals
- UL LISTED for LPG & NH<sub>3</sub> service
- Rulon™ bearings on stem and stub shafts



**ME992M-16 Series**  
2" NTP Tee Body Internal Valve w/ Manual Latch

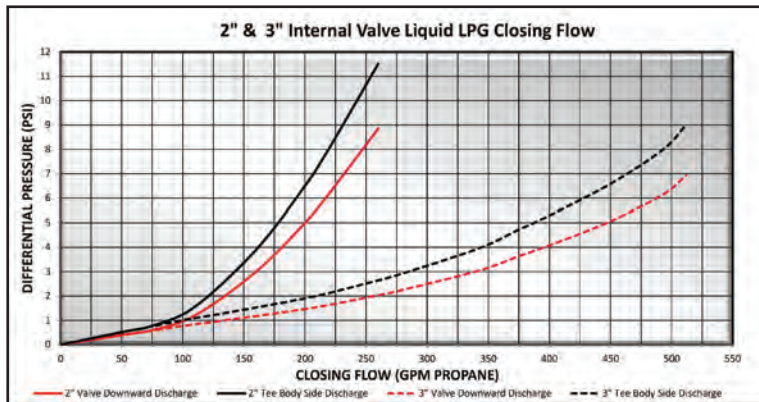
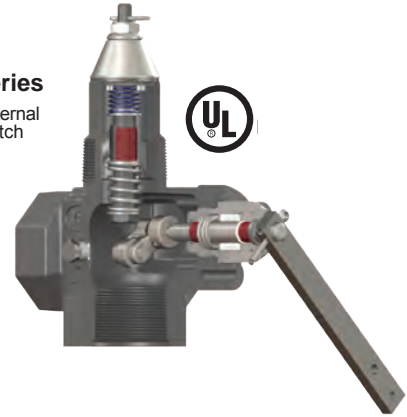

| "X" | 2" Valve Liquid Closing Flow Values |
|-----|-------------------------------------|
| 110 | 110 GPM LPG Closing Flow            |
| 160 | 160 GPM LPG Closing Flow            |
| 260 | 260 GPM LPG Closing Flow            |

| "X" | 3" Valve Liquid Closing Flow Values |
|-----|-------------------------------------|
| 175 | 175 GPM LPG Closing Flow            |
| 250 | 250 GPM LPG Closing Flow            |
| 300 | 300 GPM LPG Closing Flow            |
| 375 | 375 GPM LPG Closing Flow            |
| 475 | 475 GPM LPG Closing Flow            |
| 500 | 500 GPM LPG Closing Flow            |

NOTE: For NH<sub>3</sub> multiply GPM by .90  
Side discharge increases differential to close by approx. 2 PSIG

| Part No. *     |                      | Description  | Accessories  |
|----------------|----------------------|--|--------------|
| Ductile Iron   | CF8M Stainless Steel |  | Bell Housing |
| ME992-16-"X"   | ME992SS-16-"X"       | <b>Excelsator™</b> 2" MNPT x 2" FNPT Tee Body Internal Valve                           | MEP889-16    |
| ME992A-16-"X"  | —                    | <b>Excelsator™</b> 2" MNPT x 2" FNPT Tee Body Internal Valve - with Pneumatic Actuator |              |
| ME992AR-16-"X" | —                    | <b>Excelsator™</b> 2" MNPT x 2" FNPT Tee Body Internal Valve - with Rotary Actuator    |              |
| ME992M-16-"X"  | —                    | <b>Excelsator™</b> 2" MNPT x 2" FNPT Tee Body Internal Valve - with Manual Latch       |              |
| ME992-24-"X"   | ME992SS-24-"X"       | <b>Excelsator™</b> 3" MNPT x 3" FNPT Tee Body Internal Valve                           | MEP889-24    |
| ME992A-24-"X"  | —                    | <b>Excelsator™</b> 3" MNPT x 3" FNPT Tee Body Internal Valve - with Pneumatic Actuator |              |
| ME992AR-24-"X" | —                    | <b>Excelsator™</b> 3" MNPT x 3" FNPT Tee Body Internal Valve - with Rotary Actuator    |              |
| ME992M-24-"X"  | —                    | <b>Excelsator™</b> 3" MNPT x 3" FNPT Tee Body Internal Valve - with Manual Latch       |              |

\* Indicate desired excess flow closing value when ordering - see chart for values - i.e. ME992-24-250 (250 GPM)

To order PTFE add "T" after the prefix part number i.e. ME992T-24-250  
To order FFKM add "K" after the prefix part number i.e. ME992K-24-250  
To order FKM add "V" after the prefix part number i.e. ME992V-24-250

# 2" & 3" FLANGED TEE BODIES

Intended for use on bobtail delivery trucks, transport trucks and large storage tanks with 2" & 3" flanged connections in directional or bi-directional flow applications. Provides both manual shut-down and excess flow closing in the event of the piping being separated from the valve. Can be equipped with manual latch, pneumatic or rotary actuator or open/ closing devices. All valve models are equipped with a break-away feature in the cast body which permits the pump or piping to shear off in the event of side impact, leaving the valve poppet intact and protecting the tank from catastrophic product loss. The tee body features an additional FNPT side discharge port for liquid service applications. FOR LIQUID OR VAPOR SERVICE APPLICATIONS.

NOTE: See pages 108-110 for flanged dimensions and installation torque values.

## FEATURES

- Durable steel body with cadmium surface plating
- All stainless internal component construction
- One piece threaded packing gland
- Precision machined hard coated stem & stem guide
- Fully retained Nitrile seat disc
- Largest variety of excess flow closing values
- Corrosion resistant sleeved flange bolt holes
- Xylan coated corrosion resistant mounting studs
- Roller cam actuation
- Industry's fastest bleed time
- Removable data plate
- Industry's easiest valve to service
- Standard construction utilizes Nitrile seals
- Available with PTFE, FKM, or FFKM seals
- Available with 316 Stainless Steel bodies
- UL LISTED for LPG & NH<sub>3</sub> service
- Rulon™ bearings on stem and stub shafts

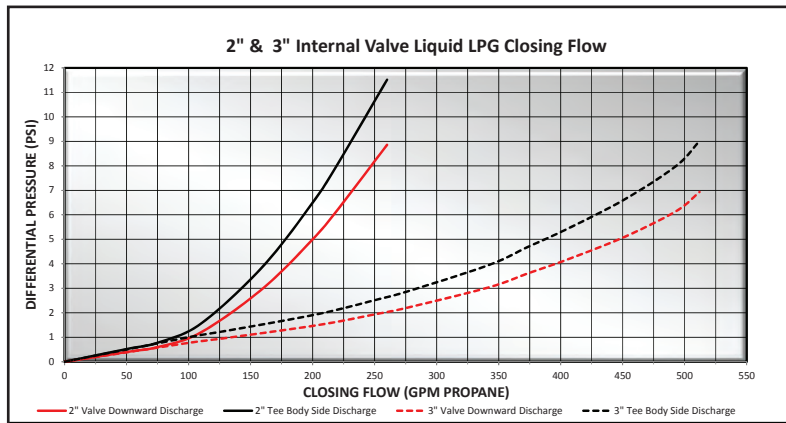

| "X" | 2" Valve Liquid Closing Flow Values |
|-----|-------------------------------------|
| 110 | 110 GPM LPG Closing Flow            |
| 160 | 160 GPM LPG Closing Flow            |
| 260 | 260 GPM LPG Closing Flow            |

| "X" | 3" Valve Liquid Closing Flow Values |
|-----|-------------------------------------|
| 175 | 175 GPM LPG Closing Flow            |
| 250 | 250 GPM LPG Closing Flow            |
| 300 | 300 GPM LPG Closing Flow            |
| 375 | 375 GPM LPG Closing Flow            |
| 475 | 475 GPM LPG Closing Flow            |
| 500 | 500 GPM LPG Closing Flow            |

NOTE: For NH<sub>3</sub> multiply GPM by .90

| Part No. *         |                      | Description   |
|--------------------|----------------------|---|
| Ductile Iron       | CF8M Stainless Steel |   |
| ME992S-2F-16-"X"   | ME992SS-2F-16-"X"    | 2"-300 lb. Modified Single Flange x 2" FNPT Tee Body Internal Valve                         |
| ME992SA-2F-16-"X"  | —                    | 2"-300 lb. Modified Single Flange x 2" FNPT Tee Body Internal Valve - w/ Pneumatic Actuator |
| ME992SAR-2F-16-"X" | —                    | 2"-300 lb. Modified Single Flange x 2" FNPT Tee Body Internal Valve - w/Rotary Actuator     |
| ME992S-3F-24-"X"   | ME992SS-3F-24-"X"    | 3"-300 lb. Modified Single Flange x 3" FNPT Tee Body Internal Valve                         |
| ME992SA-3F-24-"X"  | —                    | 3"-300 lb. Modified Single Flange x 3" FNPT Tee Body Internal Valve - w/Pneumatic Actuator  |
| ME992SAR-3F-24-"X" | —                    | 3"-300 lb. Modified Single Flange x 3" FNPT Tee Body Internal Valve - w/ Rotary Actuator    |

\* Indicate desired excess flow closing value when ordering - see chart for values i.e. ME992S-3F-24-250 (250 GPM)

To order PTFE add "T" after the prefix part number i.e. ME992ST-3F-24-250

To order FFKM add "K" after the prefix part number i.e. ME992SK-3F-24-250

To order FKM add "V" after the prefix part number i.e. ME992SV-3F-24-250



# EXCELERATOR™ INTERNAL VALVES

## 2" & 3"- 300 LB 3-WAY FLANGED TEE BODY SERIES

Intended for use on bobtail delivery trucks, transport trucks and large storage tanks with 2" & 3" flanged connections in directional or bi-directional flow applications. Provides both manual shut-down and excess flow closing in the event of the piping being separated from the valve. Can be equipped with manual latch, pneumatic or rotary actuator open/ closing devices. All valve models are equipped with a break-away feature in the cast body which permits the pump or piping to shear off in the event of side impact, leaving the valve poppet intact and protecting the tank from catastrophic product loss. The flanged tee body features an additional 300 lb. flanged side discharge port for liquid service applications.

FOR LIQUID OR VAPOR SERVICE APPLICATIONS.

NOTE: See pages 108-110 for flanged deminsions and installation torque values.

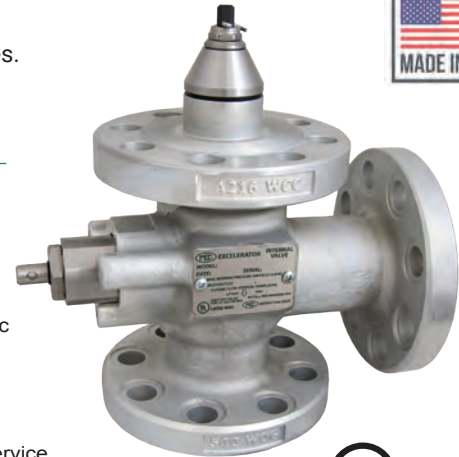

ME993S-16 Series



### FEATURES

- Durable steel body with cadmium surface plating
- All stainless internal component construction
- One piece threaded packing gland
- Precision machined hard coated stem & stem guide
- Largest variety of excess flow closing values
- Corrosion resistant sleeved flange bolt holes
- Xylan coated corrosion resistant mounting studs
- Standard construction utilizes Nitrile seals ®
- Available with PTFE, FKM, or FFKM seals
- Available with 316 Stainless Steel bodies
- Rulon™ bearings on stem and stub shafts
- Fully retained Nitrile seat disc
- Roller cam actuation
- Industry's fastest bleed time
- Removable data plate
- Industry's easiest valve to service
- LISTED for LPG & NH<sub>3</sub> service

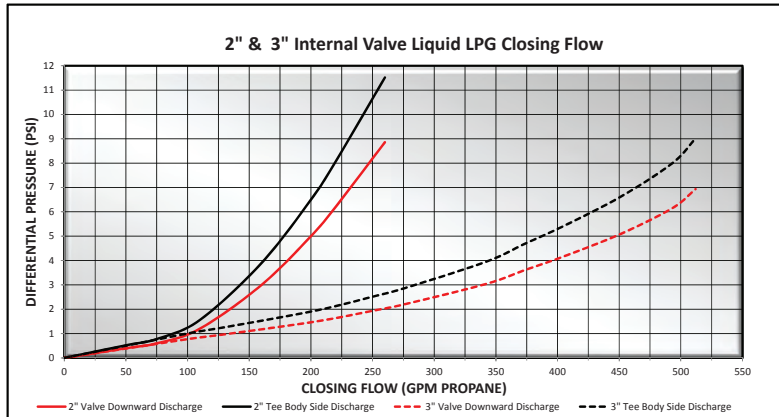

| "X" | 2" Valve Liquid Closing Flow Values |
|-----|-------------------------------------|
| 110 | 110 GPM LPG Closing Flow            |
| 160 | 160 GPM LPG Closing Flow            |
| 260 | 260 GPM LPG Closing Flow            |

| "X" | 3" Valve Liquid Closing Flow Values |
|-----|-------------------------------------|
| 175 | 175 GPM LPG Closing Flow            |
| 250 | 250 GPM LPG Closing Flow            |
| 300 | 300 GPM LPG Closing Flow            |
| 375 | 375 GPM LPG Closing Flow            |
| 475 | 475 GPM LPG Closing Flow            |
| 500 | 500 GPM LPG Closing Flow            |

NOTE: For NH<sub>3</sub> multiply GPM by .90

| Part No. *      |                      | Description  |
|-----------------|----------------------|--|
| WCC A216 Steel  | CF8M Stainless Steel |  |
| ME993S-16-"X"   | ME993SS-16-"X"       | 2"-300 lb. Modified Single Flange x (2) 2"-300 lb. Tee Body Internal Valve                           |
| ME993SA-16-"X"  | —                    | 2"-300 lb. Modified Single Flange x (2) 2"-300 lb. Tee Body Internal Valve - with Pneumatic Actuator |
| ME993SAR-16-"X" | —                    | 2"-300 lb. Modified Single Flange x (2) 2"-300 lb. Tee Body Internal Valve - with Rotary Actuator    |
| ME993S-24-"X"   | ME993SS-24-"X"       | 3"-300 lb. Modified Single Flange x (2) 3"-300 lb. Tee Body Internal Valve                           |
| ME993SA-24-"X"  | —                    | 3"-300 lb. Modified Single Flange x (2) 3"-300 lb. Tee Body Internal Valve - with Pneumatic Actuator |
| ME993SAR-24-"X" | —                    | 3"-300 lb. Modified Single Flange x (2) 3"-300 lb. Tee Body Internal Valve - with Rotary Actuator    |

\* Indicate desired excess flow closing value when ordering - see chart for values i.e. ME993S-24-250 (250 GPM)

To order PTFE add "T" after the prefix part number i.e. ME993ST-24-250

To order FFKM add "K" after the prefix part number i.e. ME993SK-24-250

To order FKM add "V" for after the prefix part number i.e. ME993SV-24-250

# EXCELA-FLANGE™ INTERNAL VALVES

## 2" - 300 LB X 2" - 8 BOLT COMPANION FLANGE

The ME994S-2F series valves feature our new modular **Excelsa-Flange™** 2"-8 bolt outlet flange design that can be easily adapted to either 2" NPT or socket weld companion flanges (MEP994S-2F-2SW) making it universal to either piping construction. FOR LIQUID OR VAPOR SERVICE APPLICATIONS.

NOTE: See pages 108-110 for flanged deminsions and installation torque values.

ME994S-2F-16 Series

### FEATURES

- Durable steel body with cadmium surface plating
- Universal 2"-8 bolt outlet flange connection for threaded or welded piping
- Universal 2"-8 bolt outlet flange provides a built-in union joint for easy servicability
- All stainless internal component construction
- One piece threaded packing gland
- Precision machined hard coated stem & stem guide
- Fully retained nitrile seat disc
- Largest variety of excess flow closing values
- Corrosion resistant sleeved flange bolt holes
- Xylan coated corrosion resistant mounting studs
- Roller cam actuation
- Industry's fastest bleed time
- Removable data plate
- Industry's easiest valve to service
- Standard construction utilizes nitrile seals
- Available with PTFE, FKM, or FFKM seals
- Available with 316 Stainless Steel bodies
- UL LISTED for LPG & NH<sub>3</sub> service
- Rulon™ bearings on stem and stub shafts
- Fits standard 2" - 300# flanged tank openings

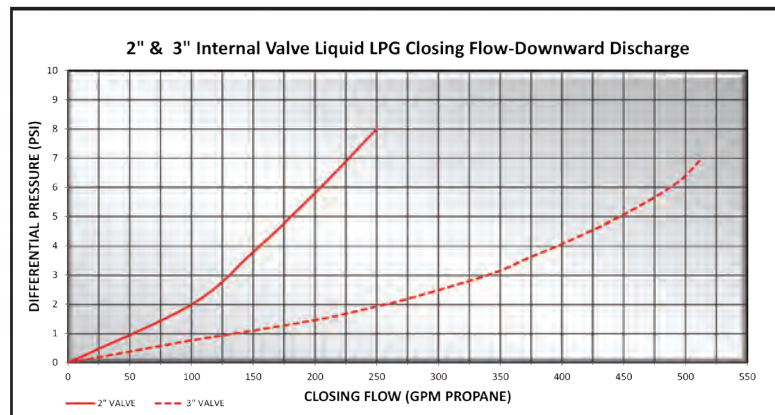

| X   | 2" Valve Liquid Closing Flow Values |
|-----|-------------------------------------|
| 110 | 110 GPM LPG Closing Flow            |
| 160 | 160 GPM LPG Closing Flow            |
| 260 | 260 GPM LPG Closing Flow            |

NOTE: For NH<sub>3</sub> Multiply GPM by .90

| Part No. *         |                      | Description   | Weight (lbs.) |
|--------------------|----------------------|---|---------------|
| WCC A216 Steel     | CF8M Stainless Steel |   |               |
| ME994S-2F-16-"X"   | ME994SS-2F-16-"X"    | Excelsa-Flange™ 2"-300 lb. Modified Single Flange x 2"-8 Bolt Flange Internal Valve                       | 21.6          |
| ME994SA-2F-16-"X"  | —                    | Excelsa-Flange™ 2"-300 lb. Modified Single Flange x 2"-8 Bolt Flange Internal Valve w/ Pneumatic Actuator | 35.5          |
| ME994SAR-2F-16-"X" | —                    | Excelsa-Flange™ 2"-300 lb. Modified Single Flange x 2"-8 Bolt Flange Internal Valve -w/ Rotary Actuator   | 28.9          |

\* Indicate desired excess flow closing value when ordering - see chart for values i.e. ME994S-2F-16-260 (260 GPM)

To order PTFE add "T" after the prefix part number i.e. ME994ST-2F-16-260

To order FFKM add "K" after the prefix part number i.e. ME994SK-2F-16-260

To order FKM add "V" for after the prefix part number i.e. ME994SV-2F-16-260

| Companion Flange Kits |                      |   |               |
|-----------------------|----------------------|---|---------------|
| Part No.              | CF8M Stainless Steel | Description   | Weight (lbs.) |
| MEP994-2F-16          | MEP994SS-2F-16       | 2" -8 Bolt x 2" FNPT Excelsa-Flange Companion Flange Kit w/ Bolts and O-Ring        | 3.5           |
| MEP994-2F-2SW         | MEP994SS-2F-2SW      | 2" -8 Bolt x 2" Socket Weld Excelsa-Flange Companion Flange Kit w/ Bolts and O-Ring | 3.6           |

# EXCELERATOR™ INTERNAL VALVES

## 3"-300 LB SINGLE FLANGED

Intended for use on transport trucks, bobtail trucks and large storage tanks with 3" flanged connections in directional or bi-directional flow applications. Provides both manual shut-down as well as excess flow closing in the event of the piping being separated from the valve. Can be equipped with a pneumatic actuator open/closing device.

FOR LIQUID OR VAPOR SERVICE APPLICATIONS.

NOTE: See pages 108-110 for flanged deminsions and installation torque values.

### FEATURES

- All stainless construction
- Precision machined stem & stem guide
- Fully retained seat disc
- Largest variety of excess flow closing values
- Corrosion resistant sleeved flange bolt holes
- Xylan coated corrosion resistant mounting studs
- Removable data plate
- Threaded packing gland with seal ejector spring
- Standard construction utilizes nitrile seals
- Available with PTFE, FKM, or FFKM seals
- UL LISTED for LPG & NH<sub>3</sub> service
- Rulon™ bearings on stem and stub shafts



| Part No. *    | Description  |
|---------------|--|
| ME990-3F-"X"  | <b>Excelsator™</b> 3" Single Flange Internal Valve - Only                    |
| ME990A-3F-"X" | <b>Excelsator™</b> 3" Single Flange Internal Valve - with Pneumatic Actuator |

\* Indicate desired excess flow closing value when ordering - see chart for values

i.e. ME990-3F-500 (500 GPM)

To order FFKM add "K" after the prefix part number i.e. ME990K-3F-500

To order Neoprene add "N" for Neoprene after the prefix part number i.e. ME990N-3F-500

To order FKM add "V" after the prefix part number i.e. ME990V-3F-500

| "X" | 3" Valve Liquid Closing Flow Values |
|-----|-------------------------------------|
| 175 | 175 GPM LPG Closing Flow            |
| 250 | 250 GPM LPG Closing Flow            |
| 300 | 300 GPM LPG Closing Flow            |
| 375 | 375 GPM LPG Closing Flow            |
| 400 | 400 GPM LPG Closing Flow            |
| 475 | 475 GPM LPG Closing Flow            |
| 500 | 500 GPM LPG Closing Flow            |

NOTE: For NH<sub>3</sub> Multiply GPM by .90

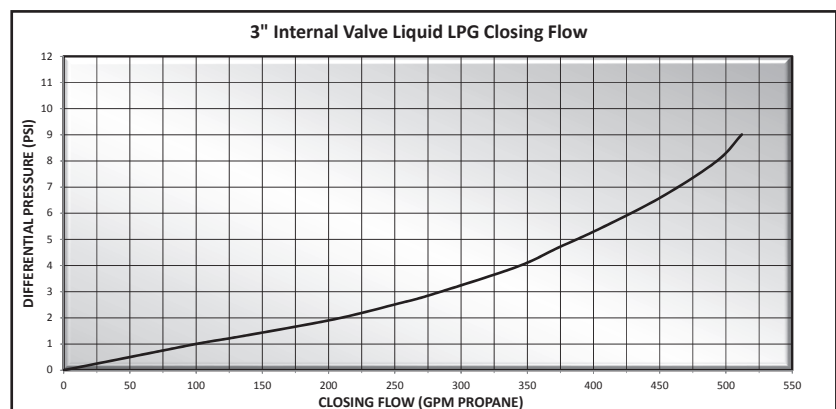

# 3"- FLANGED INTERNAL VALVES

Intended for use on bobtail delivery trucks, transport trucks and large storage tanks with 3" flanged connections in directional or bi-directional flow applications. Provides both manual shut-down and excess flow closing in the event of the piping being separated from the valve. Can be equipped with manual latch, pneumatic or rotary actuator or open/ closing devices. All valve models are equipped with a break-away feature in the cast body which permits the pump or piping to shear off in the event of side impact, leaving the valve poppet intact and protecting the tank from catastrophic product loss. FOR LIQUID OR VAPOR SERVICE APPLICATIONS.

NOTE: See pages 108-110 for flanged deminsions and installation torque values.

## FEATURES

- Durable steel body with cadmium surface plating
- All stainless internal component construction
- One piece threaded packing gland
- Precision machined hard coated stem & stem guic
- Fully retained Nitrile seat disc
- Largest variety of excess flow closing values
- Corrosion resistant sleeved flange bolt holes
- Xylan coated corrosion resistant mounting studs
- Roller cam actuation
- Industry's fastest bleed time
- Removable data plate
- Industry's easiest valve to service
- Standard construction utilizes Nitrile seals
- Available with PTFE, FKM, or FFKM seals
- Available with 316 Stainless Steel bodies
-  LISTED for LPG & NH<sub>3</sub> service
- Rulon™ bearings on stem and stub shafts



**ME990S-3F-24**  
Modified Single Flange Series



**ME990S-3DF**  
Standard Double Flange Series



**ME990S-3DFM**  
Modified Double Flange Series

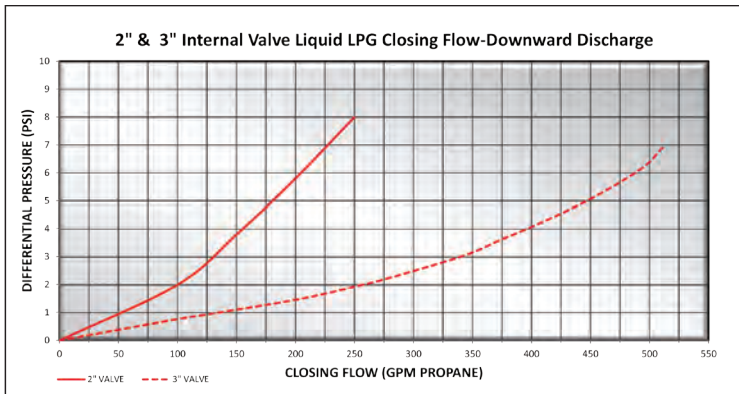

| "X" | 3" Valve Liquid Closing Flow Values |
|-----|-------------------------------------|
| 175 | 175 GPM LPG Closing Flow            |
| 250 | 250 GPM LPG Closing Flow            |
| 300 | 300 GPM LPG Closing Flow            |
| 375 | 375 GPM LPG Closing Flow            |
| 400 | 400 GPM LPG Closing Flow            |
| 475 | 475 GPM LPG Closing Flow            |
| 500 | 500 GPM LPG Closing Flow            |

NOTE: For NH<sub>3</sub> multiply GPM by .90 PM by .90

| Part No. *                |                          | Description  | Actuator Type |
|---------------------------|--------------------------|--|---------------|
| WCC A216 Steel            | CF8M Stainless Steel     |  |               |
| <b>ME990S-3DF-"X"</b>     | <b>ME990SS-SDF-"X"</b>   | <b>Excelsior™ 3" Double Flange Bobtail Internal Valve</b>                    | -             |
| <b>ME990SA-3DF-"X"</b>    | -                        |  | Pneumatic     |
| <b>ME990SAR-3DF-"X"</b>   | -                        |  | Rotary        |
| <b>ME990S-3DFM-"X"</b>    | <b>ME990SS-3DFM-"X"</b>  | <b>Excelsior™ 3"-300 lb. Modified Double Flange Internal Valve</b>           | -             |
| <b>ME990SA-3DFM-"X"</b>   | -                        |  | Pneumatic     |
| <b>ME990SAR-3DFM-"X"</b>  | -                        |  | Rotary        |
| <b>ME990S-3F-24-"X"</b>   | <b>ME990SS-3F-24-"X"</b> | <b>Excelsior™ 3"-300 lb. Modified Single Flange x 3" FNPT Internal Valve</b> | -             |
| <b>ME990SA-3F-24-"X"</b>  | -                        |  | Pneumatic     |
| <b>ME990SAR-3F-24-"X"</b> | -                        |  | Rotary        |

\* Indicate desired excess flow closing value when ordering - see chart for values i.e. ME990S-3DF-250 (250 GPM)  
 To order PTFE add "T" after the prefix part number i.e. ME990ST-3DF-300  
 To order FFKM add "K" after the prefix part number i.e. ME990SK-3DF-300  
 To order FKM add "V" after the prefix part number i.e. ME990SV-3DF-300





# EXCELA-FLANGE™ INTERNAL VALVES

## 3" - 300 LB X 3" - 8 BOLT UNIVERSAL COMPANION FLANGE SERIES

The ME994S-3F series valves feature our new modular **Excelsa-Flange™** 3"-8 bolt outlet flange design that can be easily adapted to either 3" NPT or socket weld companion flanges (MEP994S-3F-3SW) making it universal to either piping construction. FOR LIQUID OR VAPOR SERVICE APPLICATIONS.

NOTE: See pages 108-110 for flanged deminsions and installation torque values.

### FEATURES

- Durable steel body with cadmium surface plating
- Universal 3"-8 bolt outlet flange connection for threaded or welded piping
- Universal 3"-8 bolt outlet flange provides a built-in union joint for easy servicability
- All stainless internal component construction
- One piece threaded packing gland
- Precision machined hard coated stem & stem guide
- Fully retained nitrile seat disc
- Largest variety of excess flow closing values
- Corrosion resistant sleeved flange bolt holes
- Xylan coated corrosion resistant mounting studs
- Standard construction utilizes nitrile seals
- Available with 316 Stainless Steel bodies
- UL LISTED for LPG & NH<sub>3</sub> service
- Rulon™ bearings on stem and stub shafts
- Fits standard 3" - 300# flanged tank openings
- Roller cam actuation
- Industry's fastest bleed time
- Removable data plate
- Industry's easiest valve to service
- Available with PTFE, FKM, or FFKM seals



**ME994S-3F-24 Series**  
(Companion Flange not included)



| X   | 3" Valve Liquid Closing Flow Values |
|-----|-------------------------------------|
| 175 | 175 GPM LPG Closing Flow            |
| 250 | 250 GPM LPG Closing Flow            |
| 300 | 300 GPM LPG Closing Flow            |
| 375 | 375 GPM LPG Closing Flow            |
| 400 | 400 GPM LPG Closing Flow            |
| 475 | 475 GPM LPG Closing Flow            |
| 500 | 500 GPM LPG Closing Flow            |

NOTE: For NH<sub>3</sub> multiply GPM by .90

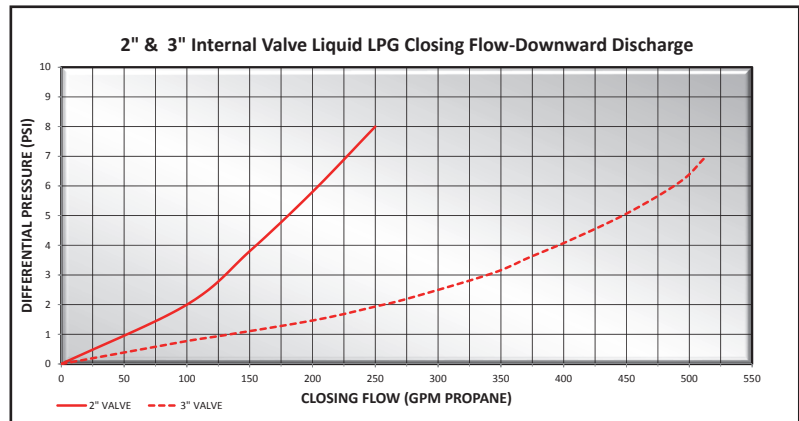

| Part No. *         |                      | Description  | Weight (lbs.) |
|--------------------|----------------------|--|---------------|
| WCC A216 Steel     | CF8M Stainless Steel |  |               |
| ME994S-3F-24-"X"   | ME994SS-3F-24-"X"    | <b>Excelsa-Flange™</b> 3"-300 lb. Modified Single Flange x 3"-8 Bolt Companion Flange Internal Valve                         | 38.3          |
| ME994SA-3F-24-"X"  | —                    | <b>Excelsa-Flange™</b> 3"-300 lb. Modified Single Flange x 3"-8 Bolt Companion Flange Internal Valve - w/ Pneumatic Actuator | 52.8          |
| ME994SAR-3F-24-"X" | —                    | <b>Excelsa-Flange™</b> 3"-300 lb. Modified Single Flange x 3"-8 Bolt Companion Flange Internal Valve - w/ Rotary Actuator    | 45.9          |

\* Indicate desired excess flow closing value when ordering - see chart for values i.e. ME994S-3F-24-260 (260 GPM)  
 To order PTFE add "T" after the prefix part number i.e. ME994ST-3F-24-260  
 To order FFKM add "K" after the prefix part number i.e. ME994SK-3F-24-260  
 To order FKM add "V" after the prefix part number i.e. ME994SV-3F-24-260

| Companion Flange Kits |   |               |
|-----------------------|---|---------------|
| Part No. *            | Description   | Weight (lbs.) |
| MEP994-3F-24          | 3" -8 Bolt x 3" FNPT <b>Excelsa-Flange™</b> Companion Flange Kit w/ Bolts and O-Ring        | 4.8           |
| MEP994-3F-3SW         | 3" -8 Bolt x 3" Socket Weld <b>Excelsa-Flange™</b> Companion Flange Kit w/ Bolts and O-Ring | 4.9           |

# EXCELERATOR™ INTERNAL VALVES

## NEXT GENERATION 3" - 300 LB DOUBLE FLANGED OFF-SET INTERNAL VALVES

Intended for use on bobtail delivery trucks with 3" flanged connections in directional or bi-directional flow applications. The 3" offset outlet flange prevents pump installation interference with truck frame rails, cross members, PTO covers, drive shafts, and other common obstacles when remounting bobtail vessels onto new chassis. In order to reduce the amount of offset from the 2" maximum to 1-1/4", simply rotate the inlet flange connection by 1 bolt hole either direction. To eliminate the offset entirely, simply rotate 1 more bolt hole. The *Excelsator™* offset is equipped with three separate packing gland locations to prevent interference while mounting the valve actuator no matter how you choose to mount the valve. Provides both manual shut-down and excess flow closing in the event the of the valve being separated from the tank. Can be equipped with pneumatic or rotary actuator open/closing devices. All valve models are equipped with a break-away feature in the cast body which permits the pump or piping to shear off in the event of side impact, leaving the valve poppet intact and protecting the tank from catastrophic product loss.

NOTE: See pages 108-110 for flanged deminsions and installation torque values.

### FEATURES

- Rotate valve body in either direction 1 bolt hole to reduce offset to 1-1/4"
- Standard with 3 gland ports for stem relocation (2 plugged)
- Each gland port can accept pneumatic or rotary type actuators
- Durable steel body with cadmium surface plating
- All stainless internal component construction
- One piece threaded packing gland
- Precision machined hard coated stem & stem guide
- Fully retained nitrile seat disc
- Largest variety of excess flow closing values
- Corrosion resistant sleeved flange bolt holes
- Xylan coated corrosion resistant mounting studs
- Roller cam actuation
- Industry's fastest bleed time
- Removable data plate
- Industry's easiest valve to service
- Standard construction utilizes nitrile seals
- Available with PTFE, FKM, or FFKM seals
- Available with 316 Stainless Steel bodies
-  LISTED for LPG & NH<sub>3</sub> service
- Rulon™ bearings on stem and stub shafts

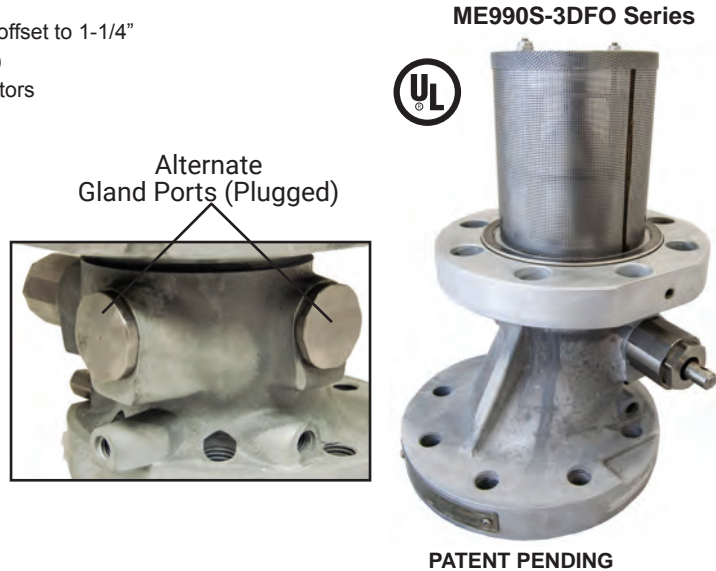

| "X" | 3" Valve Liquid Closing Flow Values |
|-----|-------------------------------------|
| 175 | 175 GPM LPG Closing Flow            |
| 250 | 250 GPM LPG Closing Flow            |
| 300 | 300 GPM LPG Closing Flow            |
| 375 | 375 GPM LPG Closing Flow            |
| 400 | 400 GPM LPG Closing Flow            |
| 475 | 475 GPM LPG Closing Flow            |
| 500 | 500 GPM LPG Closing Flow            |

NOTE: For NH<sub>3</sub> Multiply GPM by .90

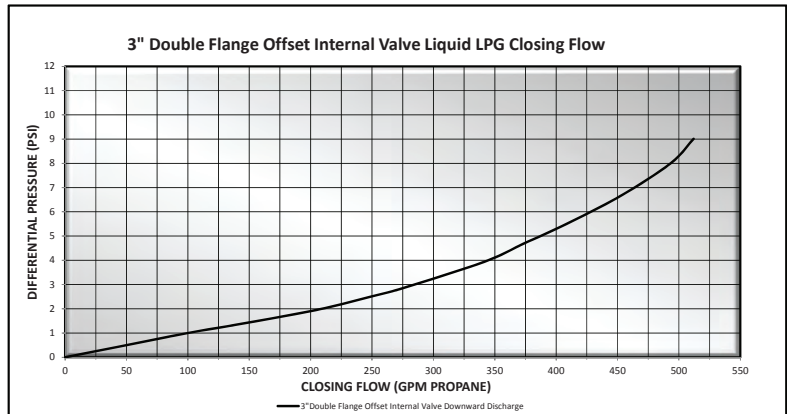

| Part No. *        |                      | Description   |
|-------------------|----------------------|---|
| WCC A216 Steel    | CF8M Stainless Steel |   |
| ME990S-3DFO-"X"   | ME990SS-3DFO-"X"     | <i>Excelsator™</i> 3" Double Flange Offset Bobtail Internal Valve                           |
| ME990SA-3DFO-"X"  | —                    | <i>Excelsator™</i> 3" Double Flange Offset Bobtail Internal Valve - with Pneumatic Actuator |
| ME990SAR-3DFO-"X" | —                    | <i>Excelsator™</i> 3" Double Flange Offset Bobtail Internal Valve - with Rotary Actuator    |

\* Indicate desired excess flow closing value when ordering - see chart for values i.e. ME990S-3DFO-250 (250 GPM)

To order PTFE add "T" after the prefix part number i.e. ME990ST-3DFO-250

To order FFKM add "K" after the prefix part number i.e. ME990SK-3DFO-300

To order FKM add "V" after the prefix part number i.e. ME990SV-3DFO-300



# EXCELERATOR™ INTERNAL VALVES

## 4" - 300 LB FLANGED

Intended for use on transport trucks and large storage tanks with 4" flanged connections in directional or bi-directional flow applications. Provides both manual shut-down as well as excess flow closing in the event of the piping being separated from the valve. Can be equipped with manual latch, pneumatic or rotary actuator open/ closing devices.

NOTE: See pages 108-110 for flanged deminsions and installation torque values.

### FEATURES

- All stainless construction
- Precision machined stem & stem guide
- Fully retained disc ss flow closing values
- Available with standard or #5 mesh filter screen
- Corrosion resistant sleeved flange bolt holes
- Xylan coated corrosion resistant mounting studs
- Removable data plate
- Threaded packing gland with seal ejector spring
- Standard construction utilizes Nitrile seals
- Available with PTFE, FKM, or FFKM seals
-  LISTED for LPG & NH<sub>3</sub> service
- Rulon™ bearings on stem and stub shafts



ME990-4F Series

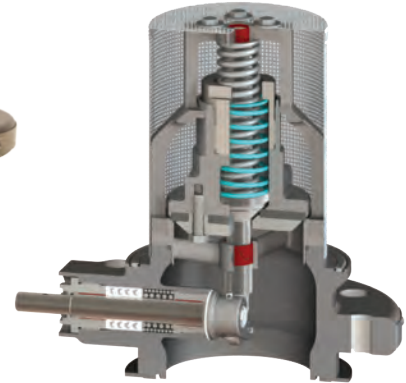

U.S. PATENT  
#9,476,518

| Part No. *     | Description   |
|----------------|---|
| ME990-4F-"X"   | Excelsator™ 4" Single Flange Internal Valve - Only                    |
| ME990A-4F-"X"  | Excelsator™ 4" Single Flange Internal Valve - with Pneumatic Actuator |
| ME990AR-4F-"X" | Excelsator™ 4" Single Flange Internal Valve - with Rotary Actuator    |
| ME990M-4F-"X"  | Excelsator™ 4" Single Flange Internal Valve - with Manual Latch       |

\* Indicate desired excess flow closing value when ordering - see chart for values - i.e. ME990-4F-650 (650 GPM)  
 For #5 Mesh screen add /5 - e.i. ME990-4F-650/5  
 To order PTFE add "T" after the prefix part number i.e. ME990T-4F-650  
 To order FFKM add "K" after the prefix part number - i.e. ME990K-4F-650  
 To order FKM add "V" after the prefix part number - i.e. ME990V-4F-650

TRUCK & PLANT EQUIPMENT

| "X"  | 4" Valve Liquid Closing Flow Values |
|------|-------------------------------------|
| 375  | 375 GPM LPG Closing Flow            |
| 500  | 500 GPM LPG Closing Flow            |
| 650  | 650 GPM LPG Closing Flow            |
| 850  | 850 GPM LPG Closing Flow            |
| 1250 | 1,250 GPM LPG Closing Flow          |
| 1500 | 1,500 GPM LPG Closing Flow          |

NOTE: For NH<sub>3</sub> Multiply GPM by .90

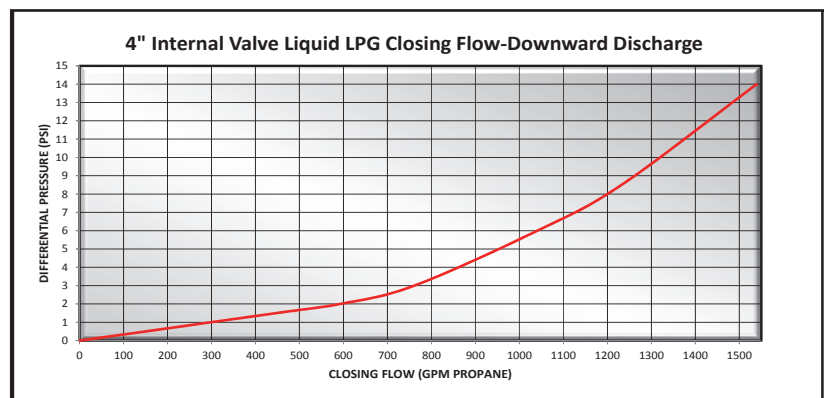

# 4" -300 LB. & 6" -300 LB DOUBLE FLANGED INTERNAL VALVES

Intended for use on transport trucks and large storage tanks with 4" or 6" flanged connections in directional or bi-directional flow applications. Provides both manual shut-down and excess flow closing in the event of the piping being separated from the valve. Equipped standard with a rotary actuator open/closing devices. All valve models are equipped with a break-away feature in the cast body which permits the pump or piping to shear off in the event of side impact, leaving the valve poppet intact and protecting the tank from catastrophic product loss.

NOTE: See pages 108-110 for flanged deminsions and installation torque values.

## FEATURES

- Durable steel body with cadmium surface plating
- All stainless internal component construction
- One piece threaded packing gland
- Precision machined hard coated stem & stem guide
- Fully retained nitrile seat disc
- Largest variety of excess flow closing values
- Corrosion resistant sleeved flange bolt holes
- Xylan coated corrosion resistant mounting studs
- Roller cam actuation
- Industry's fastest bleed time
- Removable data plate
- Industry's easiest valve to service
- Standard construction utilizes nitrile seals
- Available with PTFE, FKM, or FFKM seals
- Available with 316 Stainless Steel bodies
-  LISTED for LPG & NH<sub>3</sub> service
- Rulon™ bearings on stem and stub shafts
- Fits standard 300# flange openings



**ME990SAR-4DFM**  
4"-300LB Modified Double Flange Series



| Part No. *               |                           | Description   |
|--------------------------|---------------------------|---|
| WCC A216 Steel           | CF8M Stainless Steel      |   |
| <b>ME990SAR-4DFM-"X"</b> | <b>ME990SSAR-4DFM-"X"</b> | <b>Excelerator™</b> 4"-300 lb. Modified Double Flange Internal Valve - with Rotary Actuator |
| <b>ME990SAR-6DFM-"X"</b> | <b>ME990SSAR-6DFM-"X"</b> | <b>Excelerator™</b> 6"-300 lb. Modified Double Flange Internal Valve - with Rotary Actuator |

\* Note: Indicate desired excess flow closing value when ordering - see chart for values - i.e. ME990SAR-4DFM-375 (375 GPM)

To order PTFE add "T" after the prefix part number i.e. ME990STAR-4DFM-375

To order FFKM add "K" after the prefix part number i.e. ME990SKAR-4DFM-375

To order FKM add "V" after the prefix part number i.e. ME990SVAR-4DFM-375

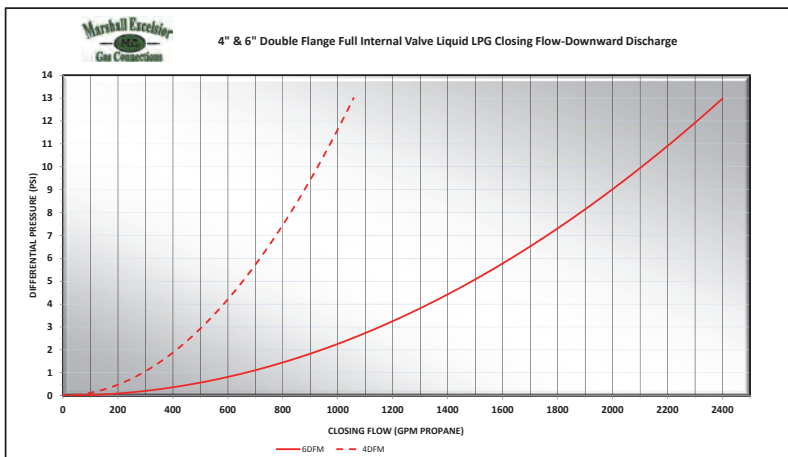

| "X"  | 4" Valve Liquid Closing Flow Values |
|------|-------------------------------------|
| 375  | 375 GPM LPG Closing Flow            |
| 500  | 500 GPM LPG Closing Flow            |
| 650  | 650 GPM LPG Closing Flow            |
| 800  | 800 GPM LPG Closing Flow            |
| 900  | 900 GPM LPG Closing Flow            |
| 1000 | 1000 GPM LPG Closing Flow           |

| "X"  | 6" Valve Liquid Closing Flow Values |
|------|-------------------------------------|
| 650  | 650 GPM LPG Closing Flow            |
| 1000 | 1000 GPM LPG Closing Flow           |
| 1250 | 1250 GPM LPG Closing Flow           |
| 1500 | 1500 GPM LPG Closing Flow           |
| 1800 | 1800 GPM LPG Closing Flow           |
| 2400 | 2400 GPM LPG Closing Flow           |

NOTE: For NH<sub>3</sub> Multiply GPM by .90



# EXCELERATOR™ INTERNAL VALVES

## TANK FLANGE CONNECTIONS

TRUCK & PLANT EQUIPMENT

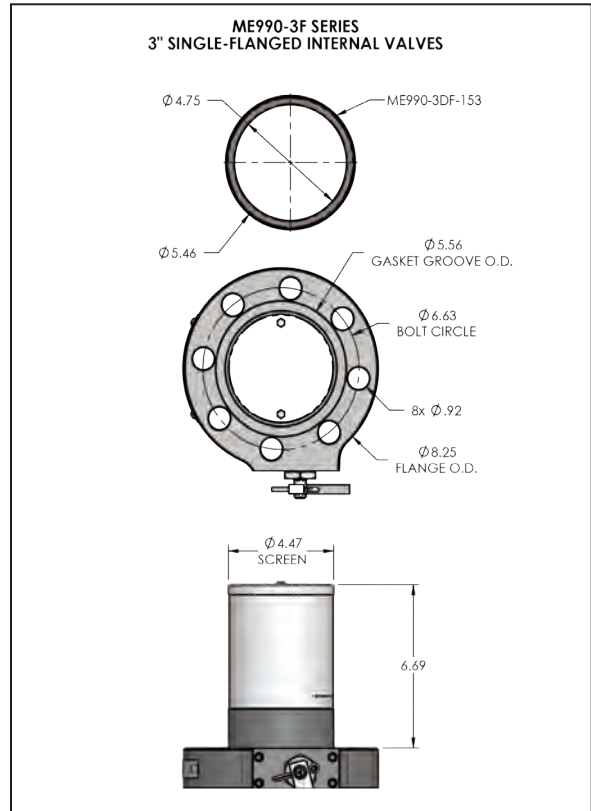
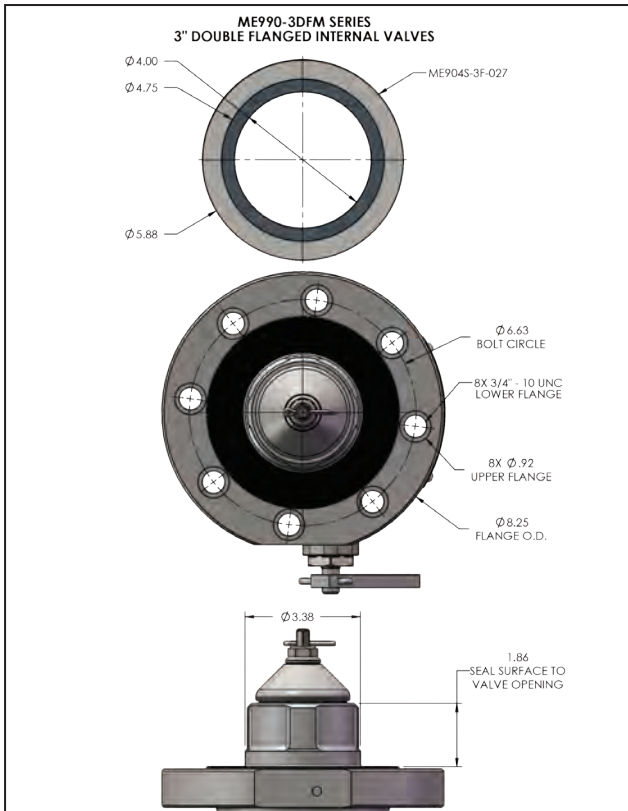
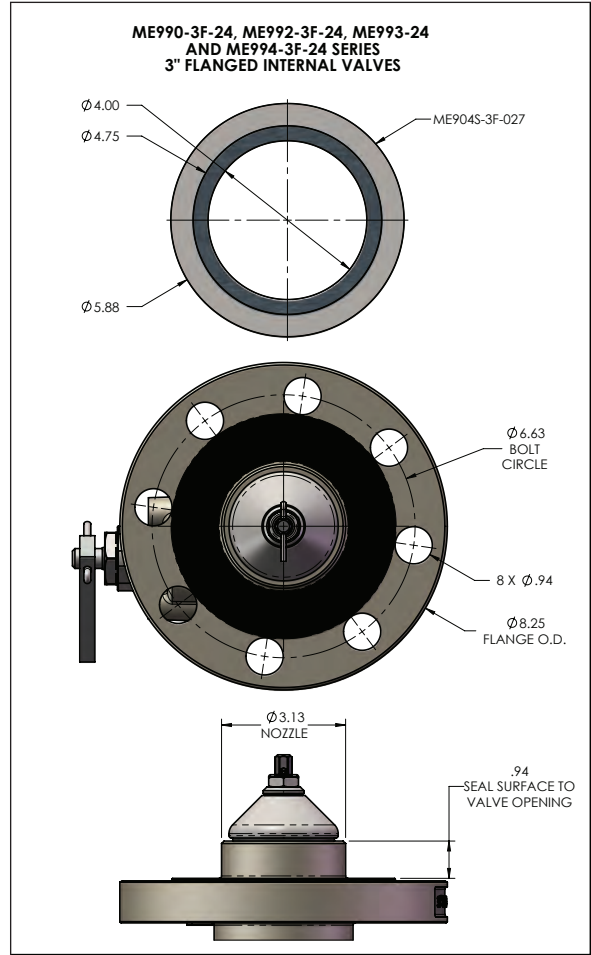
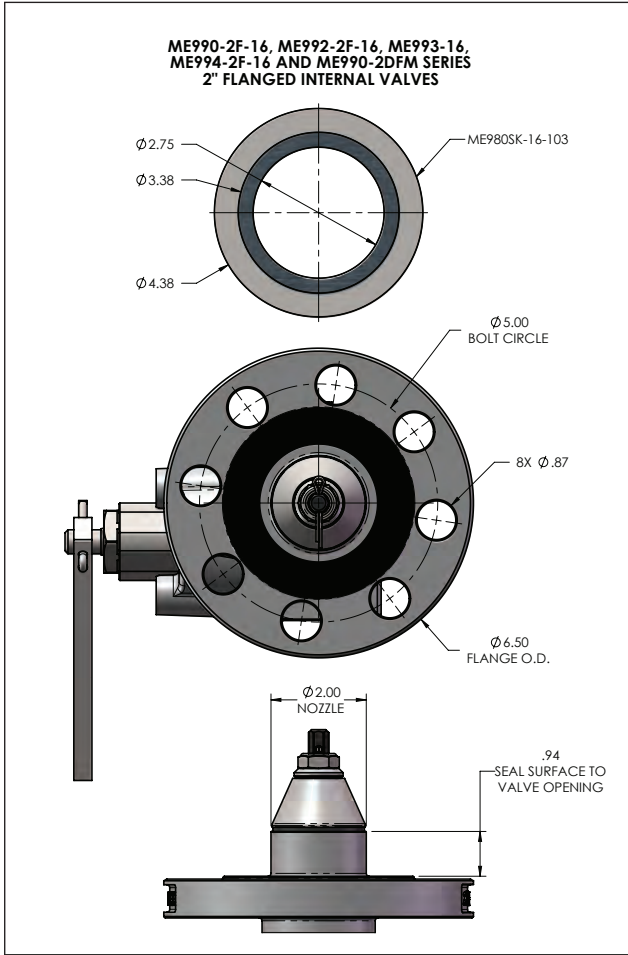

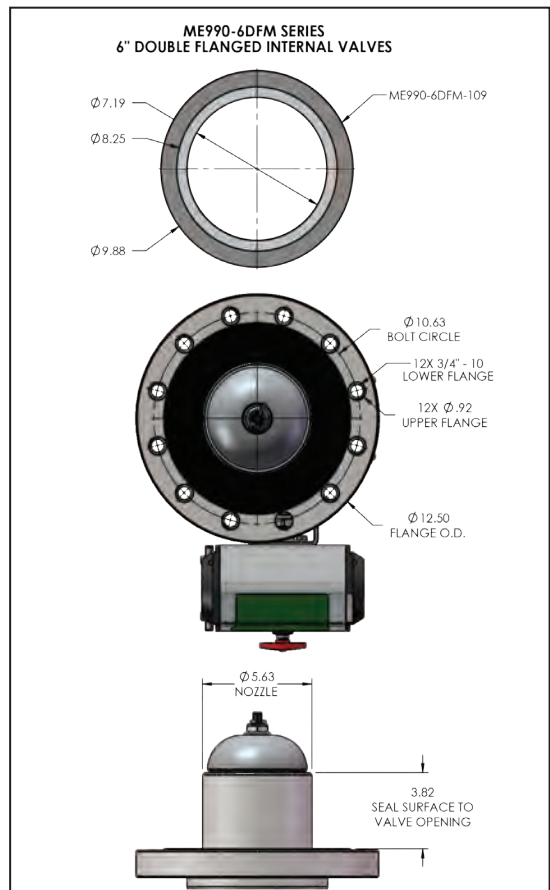
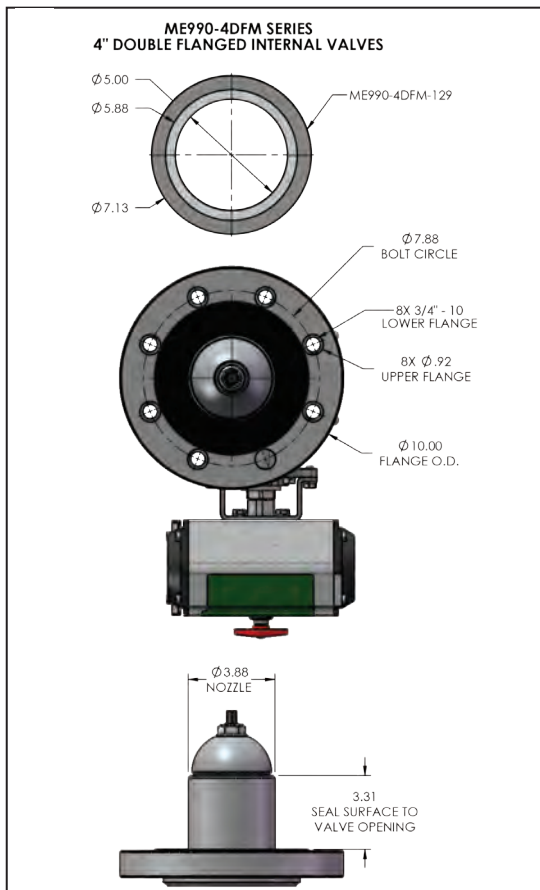
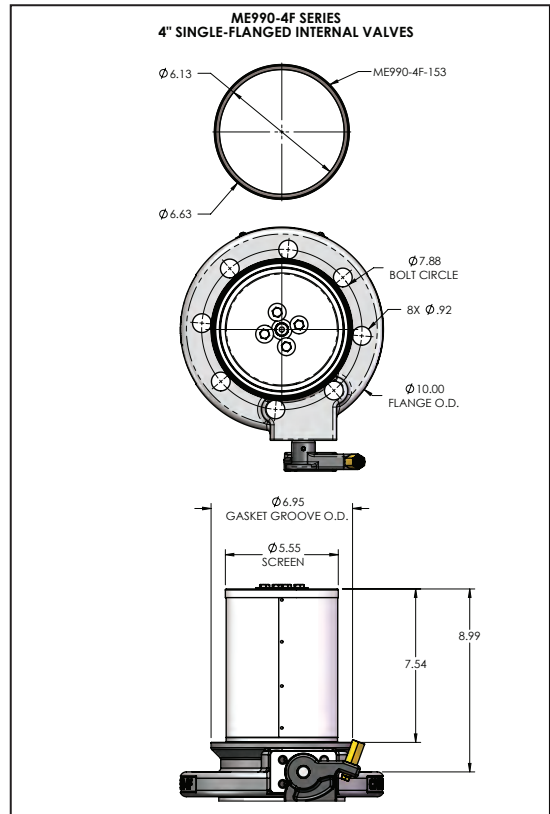
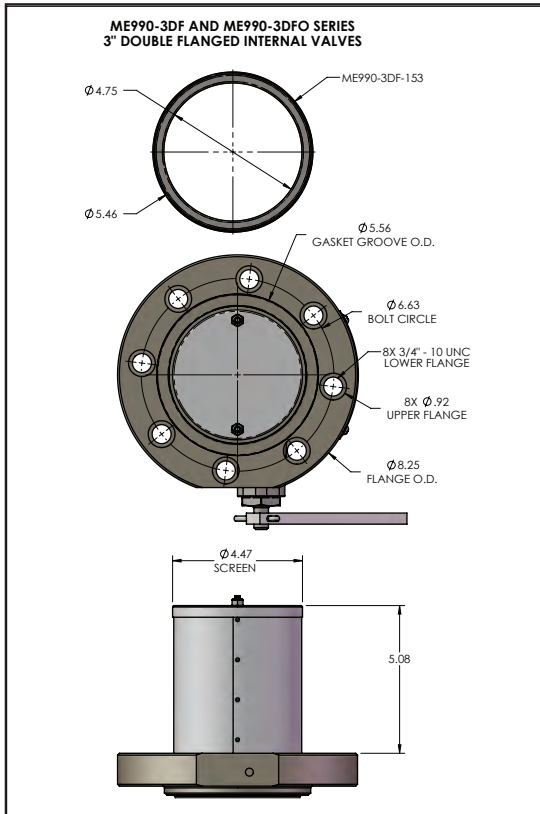

# EXCELA-FLANGE™ INTERNAL VALVES

## BOLT TORQUE REFERENCE

### ANSI / ASME Class 300 Flanges

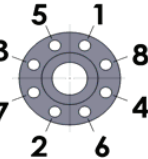
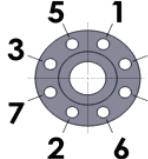
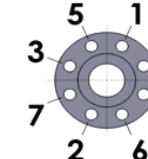
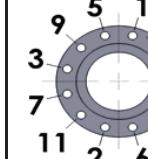
| Nominal Pipe Size                    |             | 2"  | 3"  | 4"   | 6"  |
|--------------------------------------|-------------|---|---|--|---|
| Tightening Sequence                  |             |  |  |  |  |
| Bolt / Stud                          | Size (Inch) | ∅ 5/8   | ∅ 3/4   | ∅ 3/4  | ∅ 3/4   |
|                                      | Thread      | 5/8-11 UNC  | 3/4-10 UNC  | 3/4-10 UNC   | 3/4-10 UNC  |
|                                      | Min. Grade  | B7  | B7  | B7   | B7  |
| Torque <sup>1, 2, 3</sup><br>(Ft-Lb) | Lubricated  | 110   | 200   | 200  | 200   |
|                                      | Dry         | 150   | 250   | 250  | 250   |
| Wrench Size<br>(Inch)                | Standard    | 15/16   | 1-1/8   | 1-1/8  | 1-1/8   |
|                                      | Heavy       | 1-1/16  | 1-1/4   | 1-1/4  | 1-1/4   |

### MEC Excelsa-Flanges

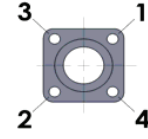
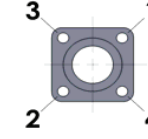
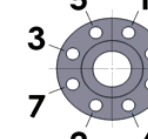
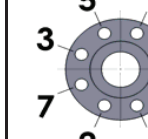
| Flange Type                          |             | 4-Bolt Square Type A / B   | 4-Bolt Square Type C   | 8-Bolt Round Companion  | 8-Bolt Round Companion   |
|--------------------------------------|-------------|--|--|---|--|
| Size (Inch)                          |             | 1-1/4, 1-1/2 & 2   | 1-1/4, 1-1/2 & 2   | 2"  | 3"   |
| Tightening Sequence                  |             |  |  |  |  |
| Bolt / Stud                          | Size (Inch) | ∅ 1/2  | ∅ 3/8  | ∅ 1/2   | ∅ 1/2  |
|                                      | Thread      | 1/2-13 UNC   | 3/8-16 UNC   | 1/2-13 UNC  | 1/2-13 UNC   |
|                                      | Min. Grade  | 8  | 8  | 8   | 8  |
| Torque <sup>1, 2, 3</sup><br>(Ft-Lb) | Lubricated  | 75   | 30   | 75  | 75   |
|                                      | Dry         | 100  | 40   | 100   | 100  |
| Wrench Size                          | (Inch)      | 3/4  | 9/16   | 3/4   | 3/4  |

<sup>1</sup> Threaded flange material and thread engagement with stud must be capable of achieving final torque

<sup>2</sup> The torque wrench used should have a minimum accuracy of 5% of full scale or 10% of indicated value

<sup>3</sup> Xylan coated studs and bolts should be installed to the "Lubricated" torque spec. due to its low friction

### Recommended Flange Installation Procedure

1. Check flanges, gasket, bolts / studs and nuts for proper material and defects
2. Apply a high quality lubricant or anti-seize on bolt / stud threads and nut contact surfaces
3. Torque bolts in sequence according to the following increments:
  - a.) Snug / hand-tight checking for even gap between flanges
  - b.) 30% of final torque
  - c.) 60% of final torque
  - d.) 100% of final torque
4. Check for leaks at maximum working pressure before putting connection into service
5. Re-tighten after 24 hours (due to gasket / bolt relaxation)
6. Consider providing additional corrosion protection, such as paint or protective coating, as necessary



# INTERNAL VALVE ACTUATORS

## POWERTORQ SERIES

These direct drive actuators are designed to maximize the life of the internal valve by eliminating side pressure on the valve's packing stem. These actuators are intended to be used at remote locations or operated directly off the air brake system in bobtail or transport applications.

The low temperature factory installed seals allow these actuators to be used with air, nitrogen, carbon dioxide or LP-Gas vapor. In case of a fire the factory provided thermal plug melts at 212° Fahrenheit releasing pressure allowing the internal valve to close. The factory set rotation of these actuators require no modification, can be oriented in any direction and all hardware needed for installation is provided.

### FEATURES

- Stainless steel all weather mounting hardware
- Field repairable under full tank pressure
- Anodized aluminum actuator body with easy to see open/close indicator
- No pinch points for operator safety
- Includes mounting bracket for ME707 Quick Release Valve  
Note: ME707 is not required for operation



#### Actuator Operating Pressure Limits:

Minimum = 25 PSIG  
Maximum = 125 PSIG  
Recommended = 40-60 PSIG

### PowerTorq Actuators



| Part No. | Actuator Type | Fits MEC*   | Fits Fisher*                         | Internal Valve   |
|----------|---------------|---|--------------------------------------|------------------|
| ME225    | Direct Drive  | ME990-10, ME991-10, ME992-10, ME992-12  | Fisher® C407                         | 1-1/4" Threaded  |
| ME226    | Direct Drive  | ME990-16, ME990-24, ME992-24, ME990S-3F-24, ME990S-2DFM, ME991-16, ME991-24, ME992-16, ME992-24, ME993S-16, ME993S-24, ME994S | Fisher® C402, C421, C427, C471, C477 | 2" & 3" Threaded |
| ME227    | Direct Drive  | ME990S-3DF & ME990S-3DFM  | Fisher® C403-24 & C483-24 Series     | 3" Double Flange |
| ME228    | Direct Drive  | ME990-4F  | Fisher® C404-32                      | 4" Single Flange |

\* Also fits Cavagna 6902900 Series internal valves

Fisher® and Fisher® Internal Valves are the trademarks of Emerson Process Management; Cavagna is the trademark of Cavagna Group

## ACCESSORIES

ME707 - The quick release valve is used in conjunction with Marshall Excelsior's air actuators to decrease the response time when closing actuators. They are particularly effective when long distances (75 feet or more) exist between the actuator and the actuator control valve.

ME708 - The 0-150 psig air pressure regulator prolongs the life of the air actuator and air system by allowing the air pressure to be set and regulated at the minimum required operating pressure for each individual system.

ME709 - The gas/air filter is used to filter foreign materials and/or particles from LP-Gas systems such as motor fuel/carburetion systems. Also designed to be used to filter air supply lines for internal and emergency shutoff valve actuator systems.

MEGR-130-50 - Pressure reducing regulator - Maximum 250 inlet, 50 PSI outlet set point



| Part No.    | Inlet     | Outlet              |
|-------------|-----------|---------------------|
| ME707       | 3/8" FNPT | 3/8" FNPT (2 Ports) |
| ME708       | 1/4" FNPT | 1/4" FNPT           |
| ME709       | 1/4" FNPT | 1/4" MNPT           |
| MEGR-130-50 | 1/4" FNPT | 1/4" FNPT           |





# INTERNAL VALVE ACTUATORS

## POWERSTROKE AND FASTROKE SERIES

Designed with a heavy duty stainless steel frame to withstand the toughest conditions. These actuators are intended to be used at remote locations or operated directly off the air brake system in bobtail or transport applications.

The actuator's smooth acting cam opens the internal valve lever when air, nitrogen, or carbon dioxide is applied to the line. When pressure to the line is released, the internal valve automatically closes. In case of a fire the factory provided thermal plug melts at 212° Fahrenheit releasing pressure allowing the internal valve to close. These actuators require no modification and all hardware needed for installation is provided.

| Part No. | Actuator Type           | Fits MEC*   | Fits*                                | Internal Valve   |
|----------|-------------------------|---|--------------------------------------|------------------|
| ME205    | Airstroke™ by Firestone | ME990-10, ME991-10, ME992-10, ME992-12  | Fisher® C407                         | 1-1/4" Threaded  |
| ME205R   | Airstroke™ by Firestone | —   | RegO® A3209R & A3209D                | 1-1/4" Threaded  |
| ME206    | #9 Chamber              | ME990-16, ME990-24, ME990S-3F-24, ME990S-2DFM, ME991-16, ME991-24, ME992-16, ME992-24, ME993S-16, ME993S-24, ME994S | Fisher® C402, C421, C471, C427, C477 | 2" & 3" Threaded |
| ME207    | #9 Chamber              | ME990S-3DF & ME990S-3DFM  | Fisher® C403-24 & C483-24 Series     | 3" Double Flange |
| ME207SF  | #9 Chamber              | ME990-3F  | Fisher® C484-24 Series               | 3" Single Flange |
| ME208SF  | #24 Chamber             | ME990-4F  | Fisher® C404-32                      | 4" Single Flange |
| ME710    | Airstroke™ by Firestone | —   | RegO® Flowmatic® Three-Way Valve     |                  |

\* Also fits Cavagna 6902900 Series internal valves



### FaStroke Actuators



#### ACTUATOR OPERATING PRESSURE LIMITS:

Minimum = 20 PSIG  
 Maximum = 125 PSIG  
 Recommended = 20-25 PSIG

#### FEATURES

- Stainless steel all weather bracket
- Field repairable without complete disconnect from internal valve
- Repairable with common automotive brake chamber
- High gloss automotive grade black epoxy coating

### PowerStroke Actuators



Airstroke™ is a trademark of Firestone Industrial Products Company, Fisher® and Fisher® Internal Valves are the trademarks of Emerson Process Management; RegO® and Flomatic® Internal Valves are the trademarks of Engineered Controls International, Inc. and Cavagna is the trademark of Cavagna Group



## ACCESSORIES



| Latches      |  |
|--------------|--|
| Part No.     | Description  |
| ME990-10-902 | <i>Excelsior</i> ™ Manual Latch Assembly for 1-1/4" & 1-1/2" Threaded Internal Valves  |
| MEP990-24    | <i>Excelsior</i> ™ Manual Latch Assy For ME990-16, ME990-24, ME991-16 and ME991-24, ME992-16, ME992-24, ME994S Internal Valves |
| MEP990-4F    | <i>Excelsior</i> ™ Manual Latch Assy For ME990-4F Series   |

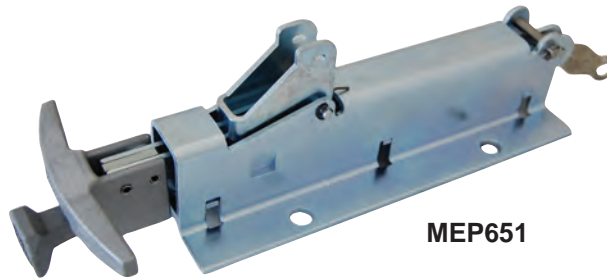

| Releases |  |
|----------|--|
| Part No. | Description  |
| MEP650   | <i>Excelsior</i> ™ Open/Close Cable Control Release with 50' Cable |
| MEP651   | <i>Excelsior</i> ™ Open/Close Cable Control Release - Only         |

## ESV / INTERNAL VALVE ACCESSORIES



| Part No.     | Description  |
|--------------|--|
| ME980-905    | Universal ESV/Internal Valve Remote Release / No Cable   |
| ME980-905-25 | Universal ESV/Internal Valve Remote Release W/ 25' Cable |
| ME980-905-50 | Universal ESV/Internal Valve Remote Release W/ 50' Cable |
| ME980-906-25 | Remote Release Cable Assy. 5/16-24UNF - 25' OAL          |
| ME980-906-50 | Remote Release Cable Assy. 5/16-24UNF - 50' OAL          |

# EMERGENCY SHUTOFF VALVE ACTUATORS

## POWERTORQ

Designed to be used with emergency shutoff valves in remote locations. Pressure to the line enables a smooth acting cam to completely open the emergency shutoff valve for full flow operation. When pressure to the line is released, the emergency shutoff valve automatically closes. In case of a fire a thermal plug melts at 212° Fahrenheit releasing pressure allowing the ESV to close. These actuators require no modification and all hardware needed for installation is provided.

The **PowerTorq** direct drive actuator maximizes the life of the emergency shutoff valve by eliminating side pressure on the valve's packing stem.

### FEATURES

- Stainless steel all weather mounting hardware
- Field repairable under full tank pressure
- Low temperature factory installed seals allow use with air, nitrogen, carbon dioxide or LP-Gas vapor
- Anodized aluminum actuator body with easy to see open/close indicator
- No pinch points for operator safety
- Factory installed thermal plug
- Includes mounting bracket for ME707 Quick Release Valve. Note: ME707 is not required for operation



#### Actuator Operating Pressure Limits:

Minimum = 25 PSIG  
 Maximum = 125 PSIG  
 Recommended = 40-60 PSIG

ME980 Series  
 Emergency Shutoff  
 Valves not included



**ME551**

#### Actuator Operating Pressure Limits:

Minimum = 20 PSIG  
 Maximum = 125 PSIG  
 Recommended = 20-25 PSIG

## SAFETY STROKE

### FEATURES

- Heavy duty stainless steel all weather bracket
- Use with air, nitrogen or carbon dioxide
- Uses existing Fisher® thermal plug

| Part No.     | Actuator Type           | Fits MEC  | Fits                | ESV             |
|--------------|-------------------------|---|---------------------|-----------------|
| <b>ME551</b> | Airstroke™ by Firestone | ME980-10, ME980-16, ME980-16-2F, ME980-24, ME980-24-3F, ME980-24-4F | Fisher® N550 Series | 1-1/4", 2" & 3" |
| <b>ME552</b> | Direct Drive            | ME980-10, ME980-16, ME980-16-2F, ME980-24, ME980-24-3F, ME980-24-4F | Fisher® N550 Series | 1-1/4", 2" & 3" |

Airstroke™ is a trademark of Firestone Industrial Products Company, Fisher® and Fisher® Internal Valves are the trademarks of Emerson Process Management



# PNEUMATIC CONTROL / E-STOP KIT

Used in conjunction with MEC pneumatic controlled emergency shutoff valves (ESV) or internal valves to remotely open and close using compressed gas. Each kit includes all necessary components for connecting and charging a pneumatic control system complete with brackets, mounting hardware, and necessary placarding in a variety of orientations for fast reliable remote system shutdown.

## FEATURES

- Heavy duty pneumatic control and charging valves
- Predrilled mounting plates and hardware
- Large easy to read placards / instruction labels
- Built in leak detection gauge
- Includes 100 FT of 1/4" poly tubing and necessary compression connectors
- Additional extension tubing and connectors available
- Suitable for use with dry air, nitrogen or LPG vapor
- Easy to install

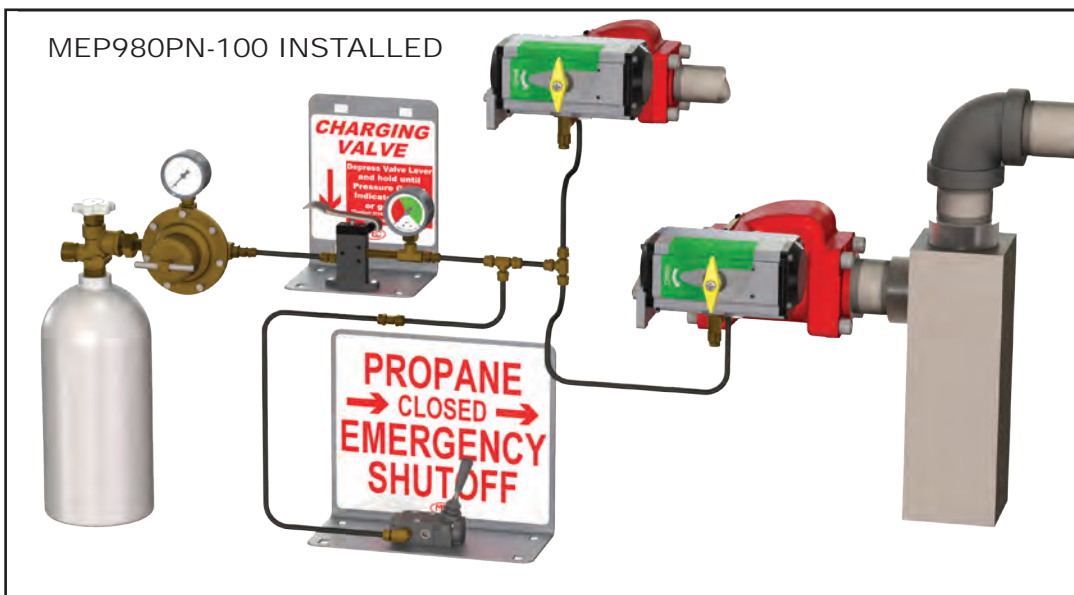

| MEC Pneumatic Control / E-Stop Kit |   |
|------------------------------------|---|
| Part No.                           | Description   |
| <b>MEP980PN-100</b>                | MEC Complete Pneumatic Controls / E-Stop Kit w/ Placards & 100' Poly Tubing |

| Accessories  |  |          |
|--------------|--|----------|
| Part No.     | Description  | Material |
| MEP980PN-105 | Compression Tube Extension Adapter - 1/8" MNPT x 1/4" CC | Brass    |
| MEP980PN-106 | Compression Tube Extension Tee - 1/4" CC                 | Brass    |
| MEP980PN-113 | Tubing Extension 1/4" x 100 ft roll                      | Poly     |
| MEP980PN-901 | Pneumatic Remote Charging Valve Assembly with Bracket    | —        |
| MEP980PN-902 | Pneumatic Remote E-Shutdown Valve Assembly with Bracket  | —        |

# INTERNAL VALVE BELL HOUSINGS

## HIGH CAPACITY - INLINE THREADED

Specifically designed to allow inline installation of threaded internal safety valves in place of traditional emergency shutoff valves. Each bell housing is designed with internal contours to allow ample unrestricted flow around standard internal safety valve closing poppets for reliable excess flow protection in the event of a downstream line failure or separation. Ideally suited for use in protecting bulkhead loading/unloading lines or other point of transfer applications when used with MEC *Excellerator*™ Internal Safety Valves.

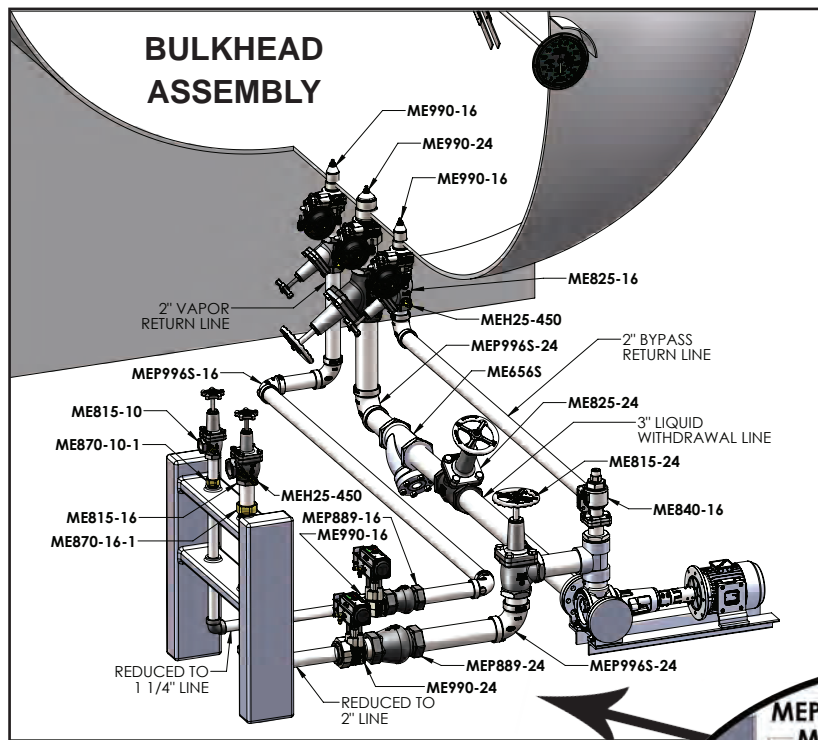

MEP889-24



MEP889-16

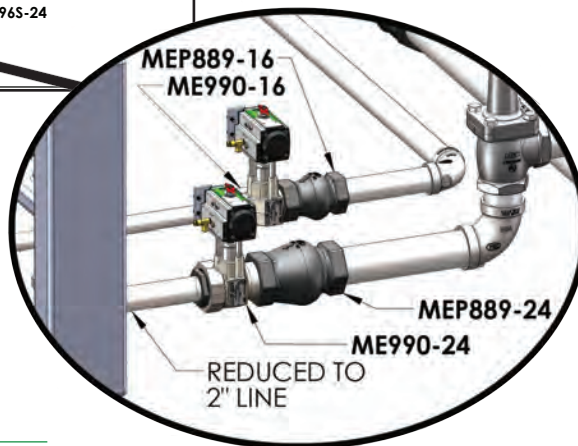

### FEATURES

- Cadmium plated ductile iron body for maximum durability
- Provides dependable excess flow protection when used with internal safety valve installed downstream
- Internal safety valves provide thermal fire protection and can be operated with manual latch or pneumatic open/close actuators
- Ideal for step down line sizing excess flow protection for compliance to NFPA 58
- Exceptionally reliable, safe, and cost effective protection of liquid or vapor transfer lines

| High Capacity Inline Threaded ESV/ISV Bell Housing |                                     |                            |
|--|-------------------------------------|----------------------------|
| Part No.   | Description                         | Fits Internal Valve Models |
| MEP889-24  | 3" FNPT Inline ESV/ISV Bell Housing | ME990-24 Series            |
| MEP889-16  | 2" FNPT Inline ESV/ISV Bell Housing | ME990-16 Series            |



# ESV/ISV BELL HOUSING KITS

## HIGH CAPACITY - FLANGED

Used in conjunction with MEC *Excellerator*™ flanged internal valves for excess flow protection on inline or drop down weld neck tank construction. Each bell housing is carefully contoured to allow ample unrestricted flow around the internal valve closing poppet for accurate and reliable excess flow protection in the event of a downstream line failure or separation. Ideally suited for protection of weld neck tank openings or as replacements to traditional emergency shut off (ESV) installations.

### FEATURES

- Cadmium plated ductile iron body for maximum durability
- Precise interior contour for maximum flow around internal valve poppet
- Includes all studs/nuts & gaskets
- Suitable for use as inline ESV when used in conjunction with *Excellerator*™ Internal Valves (internal valve sold separately)
- For use with LPG & NH3 - 400 PSI WOG

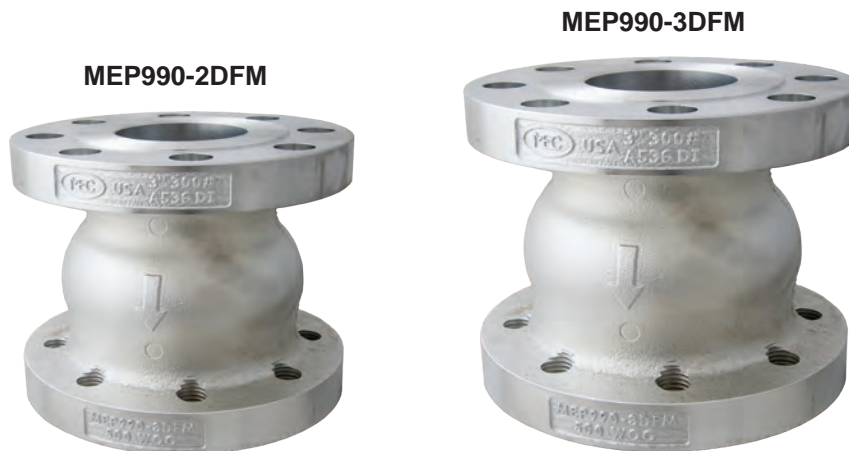

| Part No.           | Description                                    | Fits Internal Valve Models |
|--------------------|--|----------------------------|
| <b>MEP990-2DFM</b> | 2"-300# Double Flange ESV/ISV Bell Housing Kit | ME990S-2DFM Series         |
| <b>MEP990-3DFM</b> | 3"-300# Double Flange ESV/ISV Bell Housing Kit | ME990S-3DFM Series         |
| <b>MEP990-4DFM</b> | 4"-300# Double Flange ESV/ISV Bell Housing Kit | ME990S-4DFM Series         |
| <b>MEP990-6DFM</b> | 6"-300# Double Flange ESV/ISV Bell Housing Kit | ME990S-6DFM Series         |

# FLANGE REDUCING SPOOL ADAPTER

Used in conjunction with MEC *Excelsior*™ flanged internal valves for excess flow protection on inline or drop down weld neck tank construction to safely increase or decrease tank connections or line sizing in accordance to NFPA #58 code requirements. Each bell housing is carefully contoured to allow ample unrestricted flow around the internal valve closing poppet for accurate and reliable excess flow protection in the event of a downstream line failure or separation. Ideally suited for protection of weld neck tank openings, as replacements to traditional emergency shut off (ESV) installations or to adapt flanged vapor relief tank openings from 4" to 3" or vice versa such as needed to replace ACF type relief valves.

## FEATURES

- Cadmium plated ductile iron body for maximum durability
- Precise interior contour for maximum flow around internal valve poppet
- Includes all studs/nuts & gaskets
- Suitable for use as inline ESV when used in conjunction with *Excelsior*™ Internal Valves (internal valve sold separately)
- For use with LPG & NH3 - 400 PSI WOG

MEP990-4DFM/3DFM

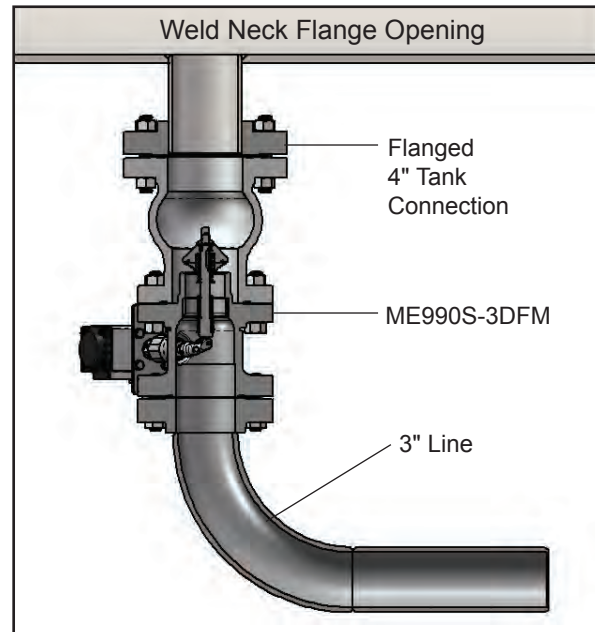
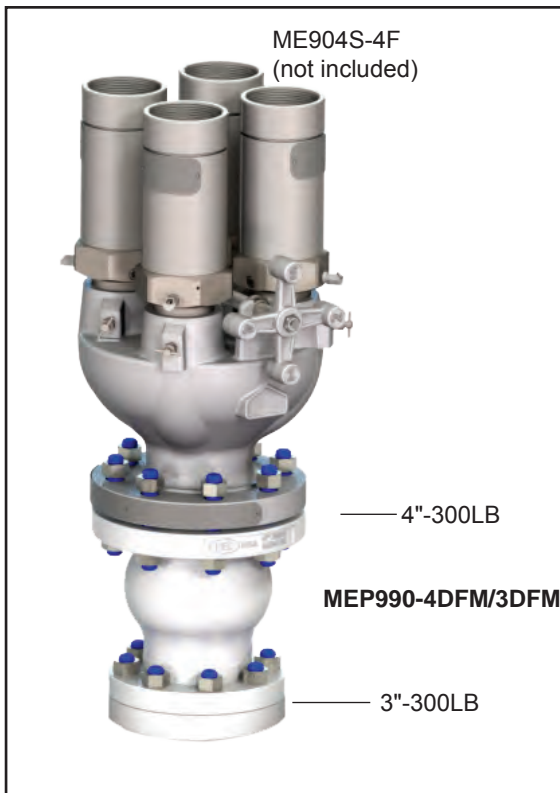

| 4" x 3" Flange Adapting Spool |  |                            |
|-------------------------------|--|----------------------------|
| Part No.                      | Description  | Fits Internal Valve Models |
| MEP990-4DFM/3DFM              | 4"-300LB x 3"-300LB Flanged ACF/ESV/ISV Adapting Spool Kit | ME990S-3DFM Series         |



# EMERGENCY SHUTOFF VALVES

Emergency Shutoff Valves (ESV's) are designed to provide as means for rapid and positive shutdown of gas lines should a down stream rupture or piping break occur. Due to the presence of a built-in fusible element at the valve operating hub the ESV will automatically close when exposed to heat between 212° F. - 250° F. These valves are ideally suited for installation at bulkheads or inline plumbing for automatic emergency shutdown as a result of fire or to provide immediate and positive manual or remote shutdown.

## FEATURES

- Powder coated ductile iron body for maximum durability
- Integral swing away valve with soft seat to promote maximum product flow and minimize product loss in the event of a fire.
- All stainless steel internal component construction provides maximum corrosion resistance
- Flanged end connection for ease of field service
- UL LISTED for use with LP Gas and Anhydrous Ammonia - 400 PSI WOG
- Integral fusible element for automatic closure when exposed to fire
- Durable PTFE packing gland and resilient seals provide long lasting service life
- Available with pneumatic or cable style latch mechanism



ME980C-6



ME980-16



ME980-16-2F  
Flange Reference pg. 106



ME980-24

| Part No.     | Description                                       | Latch Type | Material     | Flange Material | OAL     | Accessories             |
|--------------|---|------------|--------------|-----------------|---------|-------------------------|
| ME980-6      | 3/4" FNPT Emergency Shutoff Valve (ESV)           | Pneumatic  | Ductile Iron | Ductile Iron    | 4-3/4"  | -                       |
| ME980C-6     | 3/4" FNPT Emergency Shutoff Valve (ESV)           | Cable      |              | Ductile Iron    |         | -                       |
| ME980-8      | 1" FNPT Emergency Shutoff Valve (ESV)             | Pneumatic  |              | Ductile Iron    |         | -                       |
| ME980C-8     | 1" FNPT Emergency Shutoff Valve (ESV)             | Cable      |              | Ductile Iron    |         | -                       |
| ME980-10     | 1-1/4" FNPT Emergency Shutoff Valve (ESV)         | Pneumatic  |              | Ductile Iron    | 5-3/8"  | -                       |
| ME980C-10    | 1-1/4" FNPT Emergency Shutoff Valve (ESV)         | Cable      |              | Ductile Iron    |         | -                       |
| ME980-12     | 1-1/2" FNPT Emergency Shutoff Valve (ESV)         | Pneumatic  |              | Ductile Iron    |         | -                       |
| ME980C-12    | 1-1/2" FNPT Emergency Shutoff Valve (ESV)         | Cable      |              | Ductile Iron    |         | -                       |
| ME980-16     | 2" FNPT Emergency Shutoff Valve (ESV)             | Pneumatic  |              | Cast Steel      | 6-7/8"  | -                       |
| ME980C-16    | 2" FNPT Emergency Shutoff Valve (ESV)             | Cable      |              | Cast Steel      |         | -                       |
| ME980-24     | 3" FNPT Emergency Shutoff Valve (ESV)             | Pneumatic  |              | Ductile Iron    | 9-5/8"  | -                       |
| ME980C-24    | 3" FNPT Emergency Shutoff Valve (ESV)             | Cable      |              | Ductile Iron    |         | -                       |
| ME980-16-2F  | 2" - 300 lb. Flange Emergency Shutoff Valve (ESV) | Pneumatic  |              | Ductile Iron    | 11-7/8" | ME980SK-16 Stud Kit     |
| ME980C-16-2F | 2" - 300 lb. Flange Emergency Shutoff Valve (ESV) | Cable      |              | Ductile Iron    |         |                         |
| ME980-24-3F  | 3" - 300 lb. Flange Emergency Shutoff Valve (ESV) | Pneumatic  |              | Ductile Iron    | 14-1/8" | ME980SK-24 Stud/Nut Kit |
| ME980C-24-3F | 3" - 300 lb. Flange Emergency Shutoff Valve (ESV) | Cable      |              | Ductile Iron    |         |                         |
| ME980-24-4F  | 4" - 300 lb. Flange Emergency Shutoff Valve (ESV) | Pneumatic  |              | Ductile Iron    | 14-1/4" |                         |
| ME980C-24-4F | 4" - 300 lb. Flange Emergency Shutoff Valve (ESV) | Cable      |              | Ductile Iron    |         |                         |

To order ESV with Pneumatic Actuator add "A" after the prefix part number i.e. ME980A-10 (available for 1-1/4" - 4" styles)  
To order ESV with Rotary Actuator add "AR" after the prefix part number i.e. ME980AR-10 (available for 1-1/4" - 4" styles)





# EMERGENCY SHUTOFF VALVES

## HIGH CAPACITY - FLANGED

Emergency Shutoff Valves (ESV's) are designed to provide rapid and positive shutdown of gas lines should a downstream rupture or piping break occur. Due to the presence of a built-in fusible element at the valve operating hub the ESV will automatically close when exposed to heat between 212° F. - 250° F. These valves are ideally suited for installation at bulkheads or inline plumbing for automatic emergency shutdown as a result of fire or to provide immediate and positive manual or remote shutdown.

### FEATURES

- Cadmium plated steel / ductile iron body for maximum durability
- Long stroke internal valve poppet for maximum product flow
- All stainless steel internal component construction provides maximum corrosion resistance
- Flanged end connection for ease of field service
- For use with LP Gas and Anhydrous Ammonia - 400 PSI WOG
- Integral fusible element for automatic closure when exposed to fire
- Durable PTFE packing gland and resilient seals provide long lasting service life
- Pre-mounted inlet bell housing for quick and easy installation
- All mounting hardware included



| Emergency Shut Off Valves (ESV's) |   |               |
|-----------------------------------|---|---------------|
| Part No.                          | Description                                     | Actuator Type |
| ME980SAR-4DFM                     | 4" - 300LB Flange Emergency Shutoff Valve (ESV) | Rotary        |
| ME980SAR-6DFM                     | 6" - 300LB Flange Emergency Shutoff Valve (ESV) | Rotary        |



# EXCELERATOR™ HIGH FLOW RAILCAR ESV

**Excelsior™** Railcar Emergency Shutoff Valves (ESV's) are designed to provide rapid and positive shutdown of gas lines should a downstream rupture or piping break occur during product transfer. Featuring a built-in fusible element at the valve operating hub to ensure the ESV will automatically close when exposed to heat between 212° F. - 250° F. In addition to the fusible element, the Excelsior Railcar ESV's are equipped with a poppet design similar the MEC internal safety valves that provides an integral excess flow feature. MEC offers a variety of closing flow values ranging from very high liquid flow rates to more moderate vapor flow rates depending on the application. MEC **Excelsior™** Railcar ESV's are equipped standard with quick disconnect internal pneumatic operators for rapid and reliable open/close of the poppet allowing for convenient on site or remote shutdown of the valve.

## FEATURES

- 316 Stainless Steel Body
- All stainless steel internal component construction provides maximum corrosion resistance
- Hardened stainless steel flanged end connection for durability and ease of field service
-  Listed for use with LP Gas and Anhydrous Ammonia - 400 PSI WOG
- Integral fusible element for automatic closure when exposed to fire
- Durable PTFE packing gland with resilient seals providing long lasting service life
- 100% field repairable - no special tools required
- E-Z grip ribs for installation even with heavy protective hand wear

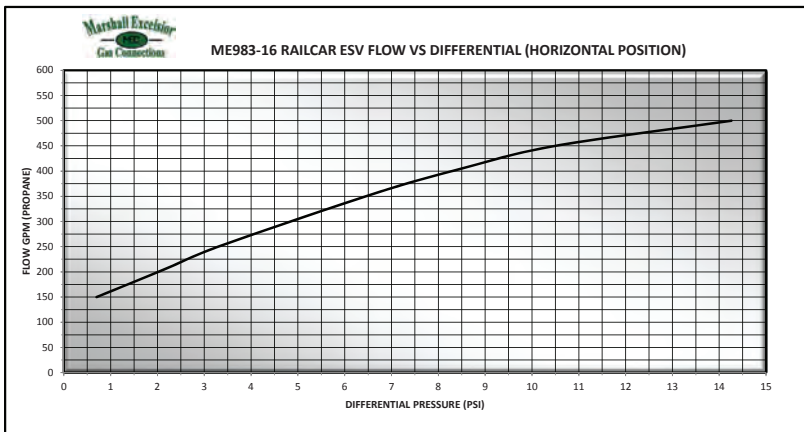

ME983 Series



| Part No.            | Description                             | Closing Flow GPM/LPG |
|---------------------|---|----------------------|
| <b>ME983-16/150</b> | High Flow Railcar ESV 2" FNPT X 2" FNPT | 150*                 |
| <b>ME983-16/250</b> | High Flow Railcar ESV 2" FNPT X 2" FNPT | 250                  |
| <b>ME983-16/500</b> | High Flow Railcar ESV 2" FNPT X 2" FNPT | 500                  |
| <b>ME983-16</b>     | High Flow Railcar ESV 2" FNPT X 2" FNPT | ~                    |

\* Recommended for vapor service - approx. closing flow 71,000 SCFH/LPG  
 ~ Available with FFKM, FKM and Neoprene seal materials  
 ~ For NH3 multiply GPM by .90

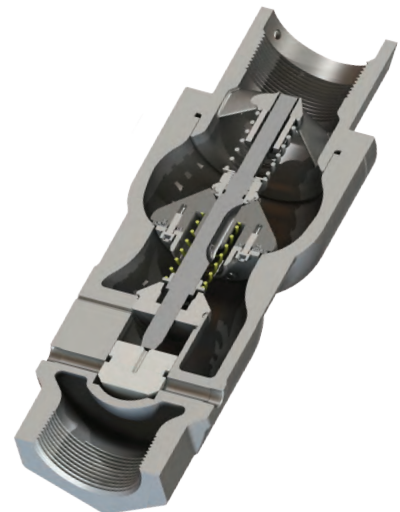

# FIRE EMERGENCY SHUT OFF VALVES

## GLOBE AND ANGLE CONFIGURATIONS

Fire Emergency Shutoff Valves (FSV's) are designed for use in conjunction with some fire suppression systems in gas-operated kitchens to provide rapid interruption of gas supply should a fire occur. The emergency shut-off valve mechanism requires a cable connection from the cam latch to the system control unit through a series of EMT conduit and corner pulleys. The valve will automatically close when the suppression system's fusible link separates in a fire condition, ultimately causing enough force on the connected cable to trip the gas shut-off trigger. The valve can also be closed manually by pulling the release cable. Once the valve has been tripped to close, it must be manually reset to restore gas service. The ME810FSV and ME820FSV series valves feature superior construction for ease of use and durability.

| Fire Emergency Shut Off Valves (FSV's) |                       |                     |
|--|-----------------------|---------------------|
| Part No.                               | Inlet & Outlet (FNPT) | 1/4" NPT side ports |
| <b>Angle</b>                           |                       |                     |
| ME810FSV-4                             | 1/2"                  | 2                   |
| ME810FSV-6                             | 3/4"                  | 2                   |
| ME810FSV-8                             | 1"                    | 2                   |
| <b>Globe</b>                           |                       |                     |
| ME820FSV-4                             | 1/2"                  | 1                   |
| ME820FSV-6                             | 3/4"                  | 1                   |
| ME820FSV-8                             | 1"                    | 1                   |



**ME810FSV Series**  
Angle style configuration



**ME820FSV Series**  
Globe style configuration

### FEATURES

- Entire valve mechanism and protective cover can be rotated 360 degrees offering maximum installation versatility
- Powder coated ductile iron body offers strength and durability
- All stainless steel internal component construction provides maximum corrosion resistance
- Release mechanism requires 10 lbs. of pull force to release allowing valve to close
- Constructed with unique handle design for easy cam reset
- Maximum operating pressure is 138 kPa (20 psig)
- Can be used in temperatures ranging from 0°C to 49°C (32°F to 120°F)
- Valves may be installed in a horizontal or vertical orientation
- S-hook included for connecting the cable from the control unit to the valve release mechanism

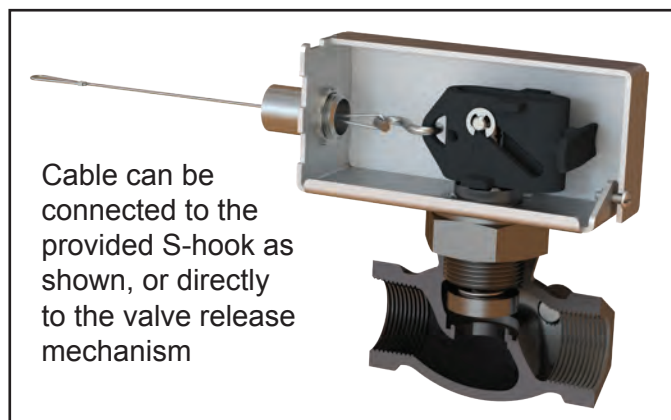

Cable can be connected to the provided S-hook as shown, or directly to the valve release mechanism



# FLOW INDICATING SWING CHECK VALVES

Promotes maximum pump efficiency by providing system operators with a visual inspection point for monitoring liquid flow conditions as well as providing a soft seat back check valve to prevent reverse product flow. Installation of a flow indicating swing check valve upstream of the pump allows the operator to observe product flow and make pump adjustments for maximum flow without cavitation. Suitable for stationary and mobile applications.



## FEATURES

- Powder coated ductile iron body for maximum durability
- Removable flanged ends for ease of field service
- Integral swing away check valve with soft seat to promote maximum product flow and prevent reverse product flow
- All stainless steel internal component construction provides maximum corrosion resistance
- Magnetically coupled flow indicator for maximum protection against leaks and minimal resistance to product flow
- Clear/Easy to read flow indicator with "Glow" arrow allows the operator to easily see if the valve is open or closed
-  LISTED for use with LP Gas and Anhydrous Ammonia - 400 PSI WOG

| Part No.    | Description   | Material     | Flange Material | OAL     |
|-------------|---|--------------|-----------------|---------|
| ME981-6     | 3/4" FNPT Flow Indicating Check Valve               | Ductile Iron | Ductile Iron    | 4-3/4"  |
| ME981-8     | 1" FNPT Flow Indicating Check Valve                 | Ductile Iron | Ductile Iron    | 4-3/4"  |
| ME981-10    | 1-1/4" FNPT Flow Indicating Check Valve             | Ductile Iron | Ductile Iron    | 5-3/8"  |
| ME981-16    | 2" FNPT Flow Indicating Check Valve                 | Ductile Iron | Cast Steel      | 6-7/8"  |
| ME981-24    | 3" FNPT Flow Indicating Check Valve                 | Ductile Iron | Ductile Iron    | 9-5/8"  |
| ME982-10    | 1-1/4" FNPT Non-Indicating Check Valve              | Ductile Iron | Ductile Iron    | 5-3/8"  |
| ME982-16    | 2" FNPT Non-Indicating Check Valve                  | Ductile Iron | Cast Steel      | 6-7/8"  |
| ME982-24    | 3" FNPT Non-Indicating Check Valve                  | Ductile Iron | Ductile Iron    | 9-5/8"  |
| ME981-16-2F | 2" - 300 lb. Flange Flow Indicating Check Valve     | Ductile Iron | Ductile Iron    | 11-7/8" |
| ME981-24-3F | 3" - 300 lb. Flange Flow Indicating Check Valve     | Ductile Iron | Ductile Iron    | 14-1/8" |
| ME981-24-4F | 4" - 300 lb. Flange Flow Indicating Check Valve     | Ductile Iron | Ductile Iron    | 14-1/4" |
| ME982-16-2F | 2" - 300 lb. Flange Flow Non-Indicating Check Valve | Ductile Iron | Ductile Iron    | 11-7/8" |
| ME982-24-3F | 3" - 300 lb. Flange Flow Non-Indicating Check Valve | Ductile Iron | Ductile Iron    | 14-1/8" |
| ME982-24-4F | 4" - 300 lb. Flange Flow Non-Indicating Check Valve | Ductile Iron | Ductile Iron    | 14-1/4" |

# EXCELA-FLANGE™ SIGHT FLOW SWING CHECK VALVE

The ME874S-16 Sight Flow Swing Check Valves feature our new modular **Excelsa-Flange™** 4-Bolt Inlet/Outlet design that can be easily adapted to both NPT thread or socket weld type A companion flanges (ME840 & ME841 Series) from 1-1/4" - 2" in diameter making it universal to piping sizes within this range. MEC Sight flow valves are designed with the most durable, impact resistant glass in the industry. This sight flow valve allows bulk plant operators an inspection point to visually monitor liquid flow conditions which allows the operator to achieve maximum pump efficiency. They also features a soft seat swing away check valve which limits flow to one direction. This check valve is usually closed until pressure activates the valve when flow is directed into piping or containers causing the valve to open. When flow stops or reverses, the check returns to the closed position minimizing product loss in the event of a line failure.

Installing a sight flow valve upstream of a plant pump, allows the operator to observe product flow and make pump adjustments for maximum flow without the liquid forming vapor bubbles causing uneven flow patterns and significantly reducing efficiency. Additionally, installing a sight flow valve at the loading arm of a plant allows the operator to maintain consistent observation of pump conditions. This valve is suitable for stationary and mobile applications. Installing this valve on a compressor operation will provide a visual indication of when the tank car or transport is emptied of liquid and ready for vapor recovery.



## FEATURES

- 4 bolt universal inlet / outlet flanges
- Specially formulated, large diameter, impact resistant sight glass with O-ring packing seals for maximum safety and visibility
- Durable ductile iron body with cadmium plated finish for maximum durability
- All stainless steel internal components for maximum corrosion resistance
- Integral swing check valve with soft seat to promote maximum product flow and minimize product loss in the event of a line failure
- Standard nitrile seat, available in FKM or FFKM
-  Listed for use with LP Gas and NH<sub>3</sub> - 400 PSI / WOG
- For use with all Type A (ME840 & ME841 Series) companion flanges

| Part No.*        | Description                                | Inlet                | Outlet               | Mating Flange Type | Weight (lbs.) |
|------------------|--|----------------------|----------------------|--------------------|---------------|
| <b>ME874S-16</b> | 2" - 4 Bolt Double Flange Sight Flow Valve | 4 Bolt Flange Type B | 4 Bolt Flange Type B | A                  | 16.0          |

\* To order no check add "NC" after the prefix part number - i.e. ME874SNC-16  
 To order FFKM add "K" after the prefix part number - i.e. ME874SK-16  
 To order FKM add "V" after the prefix part number - i.e. ME874SV-16



# SIGHT FLOW SWING CHECK VALVE

Designed with the most durable, impact resistant glass in the industry. This sight flow valve allows bulk plant operators an inspection point to visually monitor liquid flow conditions which allows the operator to achieve maximum pump efficiency. Also features a soft seat swing away check valve which limits flow to one direction. This check valve is usually closed until pressure activates the valve when flow is directed into piping or containers causing the valve to open. When flow stops or reverses, the check returns to the closed position minimizing product loss in the event of a line failure.

Installing a sight flow valve upstream of a plant pump, allows the operator to observe product flow and make pump adjustments for maximum flow without the liquid forming vapor bubbles causing uneven flow patterns and significantly reducing efficiency. Additionally, installing a sight flow valve at the loading arm of a plant allows the operator to maintain consistent observation of pump conditions. This valve is suitable for stationary and mobile applications.

Installing this valve on a compressor operation will provide a visual indication of when the tank car or transport is emptied of liquid and ready for vapor recovery.

## FEATURES

- Specially formulated, large diameter, impact resistant sight glass with O-ring packing seals for maximum safety and visibility
- Durable ductile iron body with cadmium plated finish for maximum durability
- All stainless steel internal components for maximum corrosion resistance
- Integral swing check valve with soft seat to promote maximum product flow and minimize product loss in the event of a line failure
- Standard nitrile seat, available in FKM or Neoprene
-  Listed for use with LP Gas and NH<sub>3</sub> - 400 PSI / WOG
- Hexagon cast ends for ease of installation

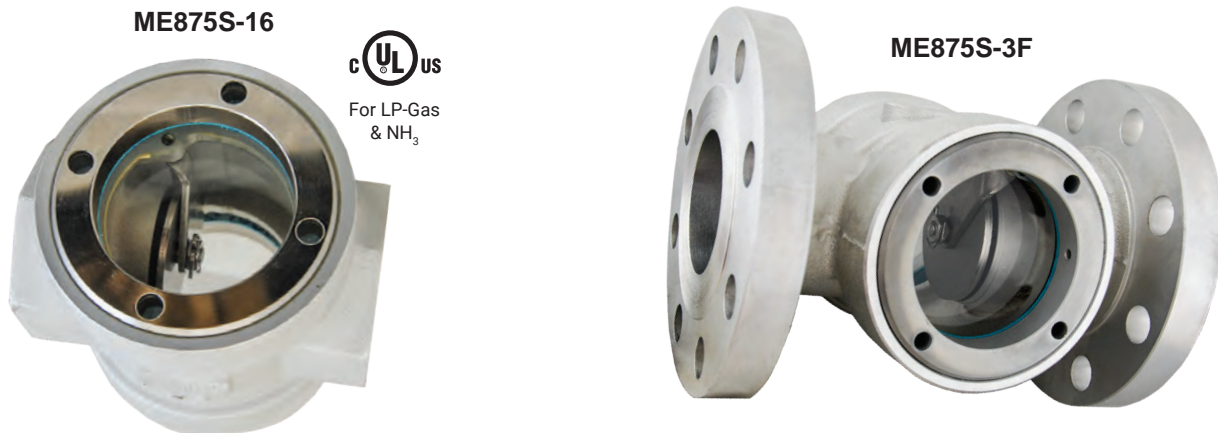

| Part No. <sup>(1)</sup>   | Inlet & Outlet FNPT | Seal Material | OAL     |
|---------------------------|---------------------|---------------|---------|
| ME875S-16                 | 2" FNPT             | Nitrile       | 5-3/4"  |
| ME875SN-16                |                     | Neoprene      | 5-3/4"  |
| ME875SV-16                |                     | FKM           | 5-3/4"  |
| ME875S-24                 | 3" FNPT             | Nitrile       | 7-3/8"  |
| ME875SN-24                |                     | Neoprene      | 7-3/8"  |
| ME875SV-24                |                     | FKM           | 7-3/8"  |
| ME875S-3F <sup>(2)</sup>  | 3"-300LB Flange     | Nitrile       | 10-1/2" |
| ME875SN-3F <sup>(2)</sup> |                     | Neoprene      | 10-1/2" |
| ME875SV-3F <sup>(2)</sup> |                     | FKM           | 10-1/2" |

(1) To order no check add "NC" after the prefix part number - i.e. ME875SNC-16

(2) Not a UL Listed Configuration

# Y-STRAINERS

Designed for flow in one direction to guard against debris in pipelines that could cause damage to pumps, valves or other equipment. Can be installed horizontally or vertically. They are available in three stainless steel mesh sizes. The mesh size equals the number of holes per square inch i.e. the smaller the number the larger the holes.

A shutoff valve installed on the filter basket outlet allows for convenient blow-off cleaning of Y-Strainer while under pressure. The ME656S Series Ductile Iron Strainers are available in 3" or 4" -300LB ANSI flange sizes with threaded blow-off ports. All strainers come standard with 40 mesh stainless steel reinforced screens for maximum durability and protection of downstream equipment. Plugs for the threaded blow-offs are available at additional cost.\*

TRUCK & PLANT EQUIPMENT



ME653SP



ME655S



ME656S



ME656S-3F

ME656S-3F-901  
ME656S-3F  
Replacement Screen

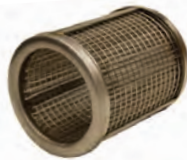

See replacement parts section

## FEATURES

- Durable ductile iron body with automotive grade powder coat finish
- Rated 600 PSI / WOG
- Optional factory installed plug\*
- Designed for LP-Gas or NH<sub>3</sub>

| Part No.*      |                |                | Blow-Off Plug Size | Inlet & Outlet FNPT |
|----------------|----------------|----------------|--------------------|---------------------|
| 20 Mesh Screen | 40 Mesh Screen | 80 Mesh Screen |                    |                     |
| ME650S/20      | ME650S         | ME650S/80      | 1/2"               | 1/2"                |
| ME651S/20      | ME651S         | ME651S/80      | 1/2"               | 3/4"                |
| ME652S/20      | ME652S         | ME652S/80      | 3/4"               | 1"                  |
| ME653S/20      | ME653S         | ME653S/80      | 3/4"               | 1-1/4"              |
| -              | ME654S         | -              | 1"                 | 1-1/2"              |
| ME655S/20      | ME655S         | ME655S/80      | 1"                 | 2"                  |
| -              | ME655S-2F      | -              | 1"                 | 2"-300 LB Flange    |
| -              | ME656S         | ME656S/80      | 1-1/4"             | 3"                  |
| -              | ME656S-3F      | -              | 1-1/4"             | 3"-300 LB Flange    |
| -              | ME656S-4F      | -              | 1-1/4"             | 4"-300 LB Flange    |

\* To add a factory installed plug use a "P" after the prefix number i.e. ME650SP/20



# LPG/NH<sub>3</sub> HIGH CAPACITY DISPENSING FILTER

The new ME680 LPG/NH<sub>3</sub> Dispenser Filter is designed to remove 99.9% of solid contaminants. These contaminants can be introduced into the system during the refining process from holding tanks as well as the delivery trucks used to transport the liquid fuel. This filter is used to protect critical engine components such as fuel injectors on propane powered vehicles which include: shuttle buses, delivery trucks and vans, taxi cabs, lift trucks, as well as turf maintenance vehicles.

The filter housing is constructed from high strength forged aluminum. The entire housing is powder coated for long term outdoor use. There are two internal primary seals inside the filter element used to prevent contaminants from entering into the downstream. There is a 1" hex nut located on the bottom of the bowl for easy removal and maintenance.

The element is constructed of pleated micro glass media, reinforced with an epoxy coated wire for added strength and corrosion resistance. This pleated element design offers a higher contaminant-loading capacity and offers a lower pressure drop than other standard elements. The element also has a pleated steel inner retainer for additional strength and durability.



## SPECIFICATIONS:

- Port Size:** 1" NPT
- Max Pressure:** 350 PSIG
- Max. Temp:** 175° F (79° C)
- Head Material:** Aluminum
- Internal Components:** Stainless Steel
- Bowl:** Aluminum
- Seals:** Nitrile
- Weight:** 5.5 lbs
- Length:** 8.07"
- Width:** 5.00"

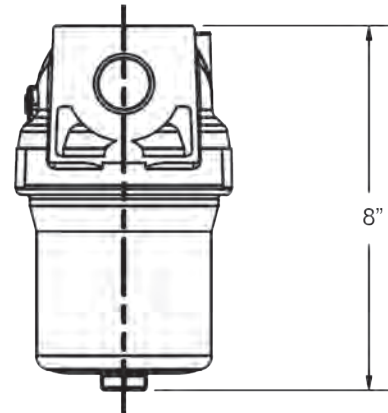

## FEATURES

- High-grade forged aluminum body construction
- Durable powder coated exterior
- 5/16-18 UNC tapped mounting holes for easy installation
- 1" hex nut on bottom of bowl for easy maintenance
- Pleated element offers higher contaminant loading capacity and lower pressure drop
- 35 GPM/LPG @ 6.2 PSI pressure differential
- Removes solid contaminants from LPG/NH<sub>3</sub> (20 micron rated element)
- 1" FNPT inlet/outlet connections
- 350 PSI maximum pressure
- 1/4" FNPT plugged ports both upstream and downstream of the filter element

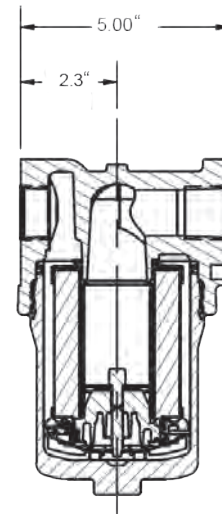

| Part No.       | Description                                     | Inlet   | Outlet  | Filter Element | Flow Rate * |
|----------------|---|---------|---------|----------------|-------------|
| <b>ME680-8</b> | High Capacity Dispensing Filter                 | 1" FNPT | 1" FNPT | 20 micron      | 35 GPM/LPG  |
| Inline Filters |   |         |         |                |             |
| Part No.       | Description                                     |         |         |                |             |
| ME204          | 1/4"MNPTx1/4"FNPT Brass Gauge Dampener / Filter |         |         |                |             |
| ME709          | 1/4"FNPT x 1/4"MNPT Inline Fuel Filter          |         |         |                |             |



**ME680-8-ERK**  
ME680-8  
Replacement Filter Element  
(see replacement parts section)



**ME204**



**ME709**





# PIPEAWAY ADAPTERS

Designed to be installed between semi-internal pressure relief valves and vent stacks or at any point in plant plumbing where breakaway protection is needed. This plated steel adapter has a weak section to help protect the relief valve if vent stack is damaged or to help protect plant plumbing from catastrophic failure.

| Part No.  | Inlet & Outlet | Material |
|-----------|----------------|----------|
| MEP104-24 | 3" FNPT        | Steel    |



# BREAKAWAY BULK HEAD ADAPTERS

Designed to be installed on the station head or at any point in plant plumbing where breakaway protection is needed. Internal hex broach allows for easy removal from plumbing if broken off.

| Part No.    | Inlet & Outlet | Material |
|-------------|----------------|----------|
| ME870-6-1   | 3/4" NPT       | Brass    |
| ME870-10-1  | 1-1/4" NPT     | Brass    |
| ME870-16-01 | 2" NPT         | Brass    |

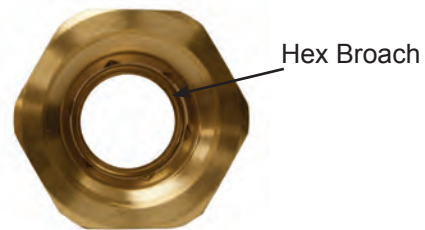

ME870-16-01

# CLAMP STYLE HOSE COUPLINGS

These hose couplings are user friendly and can be easily installed in the field. A steel or ductile hose barb is inserted into the hose and two outer clamps, positioned on the outside of the hose, have a boss to keep the bolts from rotating while the clamps compress the hose for a leak free seal.

NOTE: Clamps must be installed with clamp lip fully engaged into flange groove on hose barb body.

## FEATURES

- Hose barb constructed of zinc plated steel or ductile iron with automotive grade powder coat finish
- Ductile iron body
- Optional integrated female Acme swivel eliminates weight of additional couplings
- Includes hose barb and two clamps, nuts and bolts

| Part No.     | Hose Barb | Outlet MNPT          | Exterior Finish            |
|--------------|-----------|----------------------|----------------------------|
| ME3162-08    | 1/2"      | 1/2"                 | Zinc Plated Steel          |
| ME3162-12    | 3/4"      | 3/4"                 |                            |
| ME3162-12S   | 3/4"      | 1-3/4" F. Acme Steel |                            |
| ME3162-1216  | 3/4"      | 1"                   |                            |
| ME3162-16    | 1"        | 1"                   |                            |
| ME3162-16S   | 1"        | 1-3/4" F. Acme Steel |                            |
| ME3162-1612  | 1"        | 1-1/4"               |                            |
| ME3162-2016  | 1-1/4"    | 1"                   | Powder Coated Ductile Iron |
| ME3162-20    | 1-1/4"    | 1-1/4"               |                            |
| ME3162-2018S | 1-1/4"    | 1-3/4" F. Acme Steel |                            |
| ME3162-2020S | 1-1/4"    | 2-1/4" F. Acme Steel |                            |
| ME3162-24    | 1-1/2"    | 1-1/2"               |                            |
| ME3162-24S   | 1-1/2"    | 2-1/4" F. Acme Steel |                            |
| ME3162-32    | 2"        | 2"                   |                            |
| ME3162-32B*  | 2"        | 3-1/4" F. Acme Brass |                            |
| ME3162-32S   | 2"        | 3-1/4" F. Acme Steel |                            |

NOTE: Rated for LP-Gas



ME3162-32B



ME3162-32S



ME3162-20



# BREAKAWAY COUPLINGS

Designed to provide a safe way to transfer LP-Gas and NH<sub>3</sub> without sacrificing flow. The FloKill™ Breakaway Coupling flows both directions and protects against expensive loss of product or equipment damage if a pull-away occurs during a transfer operation. One end of the breakaway coupling should be attached to a fixed or sturdy point. In the event of an excessive amount of pull force, the breakaway coupling will separate and immediately shutoff product flow in both directions.

To reconnect the valve, pressure needs to be relieved from both ends of the line, therefore it is recommended that a safe way to bleed down the line is provided upstream and downstream. After the lines have been depressurized use Marshall Excelsior's re-installation tool (MEP128-6) for 3/4" or slide the male end into the female side and pull the collar back until they lock. After reconnection the line must be tested using Marshall Excelsior Leak Detector to check for leaks before any product is transferred. The breakaway coupling may be used on vapor or liquid lines on transports, delivery trucks, motor fuel containers, fill cabinets and other miscellaneous filling operations.

NOTE: It is recommended that breakaway couplings be safety tested monthly to confirm that proper separation occurs in the event of a pull-away. Dry air is suggested for a source of pressure during testing.

## FEATURES

- Nitrile soft seat provides positive shutoff both upstream and downstream of source
- 100—300 lbs of force required for disconnect
- Approximately 100 lbs of force to reconnect
- Large internal bore for increased flow
- Durable plated steel construction
- Rated for LP-Gas & NH<sub>3</sub>

ME860S-6



ME861S-6

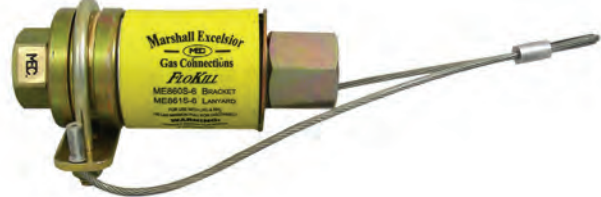

NEW 2" MODEL  
ME861S-16



| Part No.      |               | Connection FNPT | OAL Length | Accessory       |
|---------------|---------------|-----------------|------------|-----------------|
| Bracket Style | Lanyard Style |                 |            | Reassembly Tool |
| ME860S-6      | ME861S-6      | 3/4"            | 6"         | MEP128-6        |
| ME860S-8      | ME861S-8      | 1"              | 6-3/4"     | —               |
| ME860S-10     | ME861S-10     | 1-1/4"          | 7-3/4"     | —               |
| —             | ME861S-16*    | 2"              | 10-1/4"    | —               |

\* Rated for LP Gas Only

MEP128-6  
Coupling Not Included

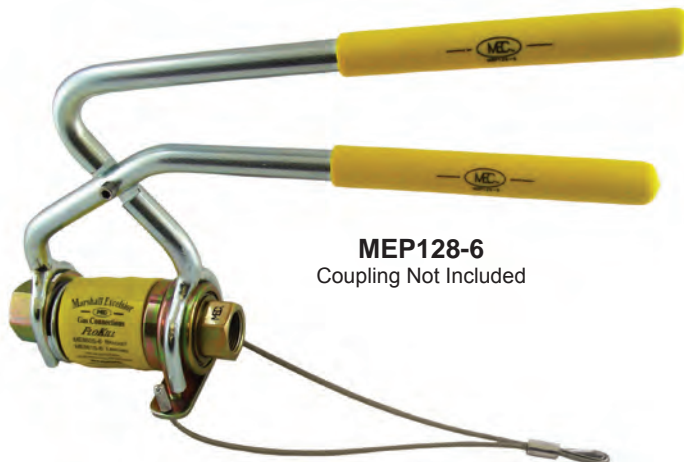

# FILLER & VAPOR COUPLINGS

These couplings are used as connections between the hose and transfer valve. The filler coupling is designed to provide different connections for the end of a hose (inlet) or an angle, globe or quick acting valve (outlet) when transferring liquid. The vapor coupling is designed to be used with valves having an upper check mechanism. The nose piece on the vapor coupling opens the check valve allowing vapor equalization.

The extended style has a stainless steel female Acme nut insert cast into the heavy duty aluminum handle. All filler and vapor couplings come with a factory installed retaining ring unless noted. The retaining ring limits the travel of the handle or nut during disconnect reducing spin-offs and promoting proper venting of the captured product.

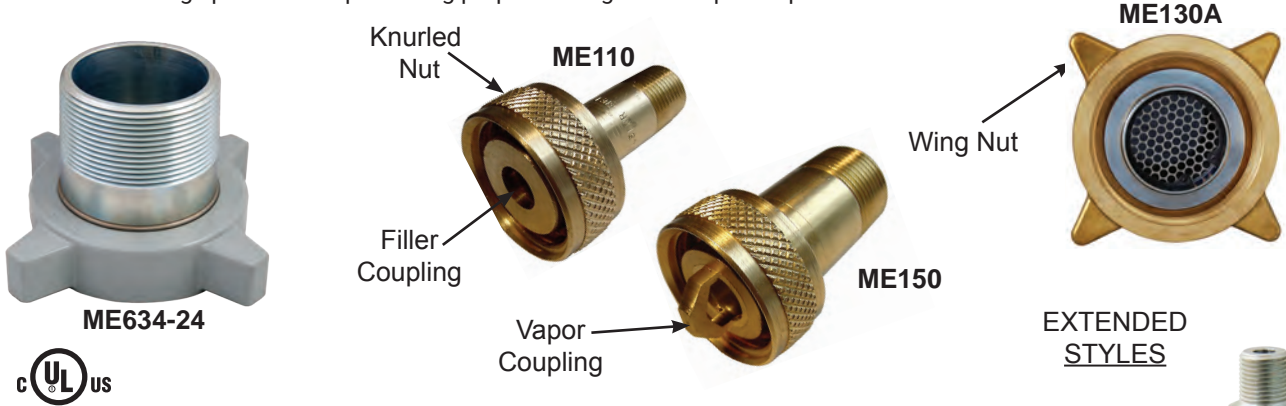

TRUCK & PLANT EQUIPMENT

| Service Type | Part No.    |                                |                                 |             |                       |                 |           | F. Acme | MNPT      |
|--------------|-------------|--------------------------------|---------------------------------|-------------|-----------------------|-----------------|-----------|---------|-----------|
|              | Brass       |                                | Brass Wing Nut/Steel Nipple     | Steel*      |                       |                 |           |         |           |
|              | Knurled Nut | Wing Nut                       |                                 | Knurled Nut | Wing Nut              | Extended Handle |           |         |           |
|              |             |                                |                                 |             | Standard              | Fluted          |           |         |           |
| Liquid       | ME100       | —                              | —                               | —           | —                     | —               | —         | 1-1/4"  | 3/8"      |
|              | ME101       | —                              | —                               | —           | —                     | —               | —         | 1-1/4"  | 1/2"      |
|              | ME110       | ME110C                         | —                               | —           | —                     | ME635-4         | ME635G-4  | 1-3/4"  | 1/2"      |
|              | ME111       | ME111C                         | —                               | ME111S      | ME111SC               | ME635-6         | ME635G-6  | 1-3/4"  | 3/4"      |
|              | —           | —                              | —                               | —           | ME113SC               | —               | —         | 1-3/4"  | 3/4" FNPT |
|              | ME112       | ME112C                         | —                               | ME112S      | ME112SC               | ME635-8         | ME635G-8  | 1-3/4"  | 1"        |
|              | —           | —                              | —                               | —           | —                     | ME635-10        | ME635G-10 | 1-3/4"  | 1-1/4"    |
|              | —           | ME120**<br>ME120WR             | ME120S**<br>ME120SWR            | —           | ME121S**<br>ME121S-WR | —               | —         | 2-1/4"  | 1-1/4"    |
|              | —           | ME130B**<br>ME130BWR           | ME130**<br>ME130A***<br>ME130WR | —           | ME130S**<br>ME130S-WR | —               | —         | 3-1/4"  | 2"        |
| —            | —           | ME664-24<br>(Bronze/<br>Steel) | —                               | ME634-24    | —                     | —               | 4-1/4"    | 3"      |           |
| Vapor        | ME140       | —                              | —                               | —           | —                     | —               | —         | 1-1/4"  | 3/8"      |
|              | ME141       | —                              | —                               | ME141S      | —                     | —               | ME645G-4  | 1-1/4"  | 1/2"      |
|              | —           | —                              | —                               | —           | —                     | —               | ME645G-6  | 1-1/4"  | 3/4"      |
|              | —           | —                              | —                               | —           | —                     | ME646-4         | ME646G-4  | 1-3/4"  | 1/2"      |
|              | ME150       | ME150C                         | —                               | ME150S      | ME150SC               | ME646-6         | ME646G-6  | 1-3/4"  | 3/4"      |
|              | ME151       | ME151C                         | —                               | ME151S      | ME151SC               | ME646-8         | ME646G-8  | 1-3/4"  | 1"        |
|              | —           | —                              | —                               | —           | —                     | ME646-10        | ME646G-10 | 1-3/4"  | 1-1/4"    |
|              | —           | —                              | ME160                           | —           | ME160S                | —               | —         | 2-1/4"  | 1-1/4"    |



\* Rated for LP-Gas & NH<sub>3</sub>  
 \*\* Does not include a factory installed retaining ring  
 \*\*\* Includes factory installed filter screen  
**NOTE:** Pressure rated for 400 WOG  
 ME634-24 & ME664-24 Non-UL Rated



# 3-1/4" EXTENDED ACME ADAPTER W/ EXTENDED RELIEF AND BLOWDOWN PORTS

The **ME503JT Series Acme adapters** (available in brass or steel construction) feature an extended body designed to allow blowdown line and hydrostatic relief installation directly from the fitting in transport inlet/outlet plumbing installations.

The Extended Acme Adapter is 2" MNPT x 3-1/4" Male Acme, featuring both 1/4" FNPT and 1/2" FNPT side auxiliary ports, allowing direct connection of the blowdown line and installation of a hydrostatic pressure relief valve (MEH225 Series) or bleed valve (MEJ400 Series).

**ME503JT-16**



## FEATURES

- Durable brass or steel construction
- Adapters include Nitrile Acme gasket
- Rated 400 WOG
- Reduces amount of components for the blowdown line set-up
- Reduces potential leak points
- Eliminates the need for welding
- Reduced assembly time
- Reduces weight on the transport truck

### CURRENT ASSEMBLY PROCESS



### ME503JT-16 ASSEMBLY PROCESS

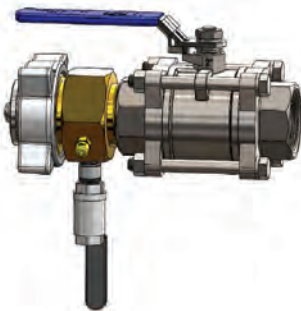

### CURRENT BLOWDOWN ASSEMBLY PROCESS



### ME503JT-16 ASSEMBLY PROCESS



| Part No.           | Description                                       | Aux. Hole #1 | Aux. Hole #2 | Material | Application |     |
|--------------------|---|--------------|--------------|----------|-------------|-----|
|                    |   |              |              |          | LPG         | NH3 |
| <b>ME503JT-16</b>  | 3-1/4" M. Acme x 2" MNPT Adapter w/ extended body | 1/4" NPT     | 1/2" NPT     | Brass    | Y           | N   |
| <b>ME503SJT-16</b> |   |              |              | Steel    | Y           | Y   |

| Accessories |  |
|-------------|--|
| Part No.    | Description  |
| MEH225      | Hydrostatic Relief Valve - Brass                         |
| MEH225SS    | Hydrostatic Relief Valve - Stainless Steel               |
| MEJ400      | Liquid Level Vent Valve - Brass                          |
| MEJ400/72   | Low Emission Liquid Level Vent Valve #72 Orifice - Brass |
| MEJ400SC    | Self Cleaning Liquid Level Vent Valve - Brass            |
| MEJ402S     | Liquid Level Vent Valve w/ T-Handle - Stainless Steel    |

# ACME ADAPTERS

| Part No.    |                          |              | M. Acme | FNPT   | MNPT      |
|-------------|--------------------------|--------------|---------|--------|-----------|
| Brass       |                          | Steel*       |         |        |           |
| No Screen   | Factory Installed Screen |              |         |        |           |
| ME498-4/2   | —                        | —            | 1-1/4"  | 1/4"   | 1/2" **   |
| ME498-6/3   | —                        | —            | 1-1/4"  | 3/8"   | 3/4" **   |
| ME192       | —                        | —            | 1-1/4"  | 1/2"   | —         |
| ME193       | —                        | —            | 1-1/4"  | 3/4"   | —         |
| ME210       | —                        | —            | 1-3/4"  | 1/4"   | —         |
| ME211       | —                        | —            | 1-3/4"  | 3/8"   | —         |
| ME212       | —                        | —            | 1-3/4"  | 1/2"   | —         |
| ME213       | —                        | ME213S       | 1-3/4"  | 3/4"   | —         |
| ME214       | —                        | ME214S       | 1-3/4"  | 1"     | —         |
| ME502-12/8  | —                        | —            | 2-1/4"  | 1"     | 1-1/2" ** |
| ME502-16/10 | —                        | ME502S-16/10 | 2-1/4"  | 1-1/4" | 2" **     |
| ME502-16/12 | —                        | —            | 2-1/4"  | 1-1/2" | 2" **     |
| ME250       | ME250A                   | —            | 3-1/4"  | 1-1/4" | —         |
| ME251       | ME251A                   | —            | 3-1/4"  | 1-1/2" | —         |
| ME252-16    | ME252A-16                | ME252S-16    | 3-1/4"  | 2"     | —         |
| ME508-24    | ME508A-24                | ME508S-24    | 3-1/4"  | 3"     | —         |



ME192



ME212



ME252S-16



\* Rated for LP-Gas & NH<sub>3</sub>  
 \*\* Male Thread Outside & Female Thread Inside  
 NOTE: Pressure rated for 400 WOG



ME503J-16

1/4" FNPT with Vent Hole & #54 Orifice



ME503JB-16

Brass Vent Valve

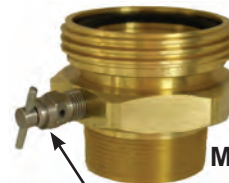

ME503JS-16

Stainless Steel Vent Valve

| Part No.                                  |                                    |  |   |                                    |  | M. Acme | FNPT/<br>MNPT |
|---|------------------------------------|--|---|------------------------------------|--|---------|---------------|
| Brass                                     |                                    |  | Steel*                                    |                                    |  |         |               |
| Factory Machined 1/4" FNPT with Vent Hole | Factory Installed Brass Vent Valve | Factory Installed Stainless Steel Vent Valve | Factory Machined 1/4" FNPT with Vent Hole | Factory Installed Brass Vent Valve | Factory Installed Stainless Steel Vent Valve |         |               |
| ME252J-16                                 | ME252JB-16                         | ME252JS-16                                   | ME252SJ-16                                | ME252SJB-16                        | ME252SJS-16                                  | 3-1/4"  | 2" FNPT       |
| ME503J-16                                 | ME503JB-16                         | ME503JS-16                                   | ME503SJ-16                                | ME503SJB-16                        | ME503SJS-16                                  | 3-1/4"  | 2" MNPT       |

NOTE: To add a factory installed screen use an "A" after the prefix number i.e. ME252AJB-16

Pressure rated for 400 WOG

\* Rated for LP-Gas & NH<sub>3</sub>



| Part No. |        | M. Acme | Female UNC Thread |
|----------|--------|---------|-------------------|
| Brass    | Steel* |         |                   |
| ME209    | ME209S | 1-3/4"  | 3/8"-16           |

To hold hose end valve secure when not in use

\* Rated for LP-Gas & NH<sub>3</sub>



| Part No.                |                     |                          |                                  |                     | M. Acme | MNPT   | FNPT                  |
|-------------------------|---------------------|--------------------------|----------------------------------|---------------------|---------|--------|-----------------------|
| Brass                   |                     |                          | Steel <sup>(1)</sup>             |                     |         |        |                       |
| No Screen               | 1/8" FNPT Side Port | Factory Installed Screen | No Screen                        | 1/8" FNPT Side Port |         |        |                       |
| ME498-4/2               | -                   | -                        | -                                | -                   | 1-1/4"  | 1/2"   | 1/4" <sup>(2)</sup>   |
| ME498-6/3               | -                   | -                        | -                                | -                   | 1-1/4"  | 3/4"   | 3/8" <sup>(2)</sup>   |
| -                       | -                   | -                        | ME520S-8                         | -                   | 1-1/4"  | 1"     | -                     |
| -                       | -                   | -                        | ME521S-4                         | -                   | 1-3/4"  | 1/2"   | -                     |
| ME215                   | -                   | -                        | ME215S<br>ME215SS <sup>(4)</sup> | -                   | 1-3/4"  | 3/4"   | -                     |
| ME216                   | -                   | -                        | ME216S                           | -                   | 1-3/4"  | 1"     | -                     |
| ME217                   | ME217J              | ME217A                   | ME217S                           | ME217SJ             | 1-3/4"  | 1-1/4" | -                     |
| ME233                   | ME233J              | -                        | ME233S                           | ME233SJ             | 2-1/4"  | 1-1/4" | -                     |
| ME502-12/8              | -                   | -                        | -                                | -                   | 2-1/4"  | 1-1/2" | 1" <sup>(2)</sup>     |
| ME502-16/10             | -                   | -                        | ME502S-16/10                     | -                   | 2-1/4"  | 2"     | 1-1/4" <sup>(2)</sup> |
| ME502-16/12             | -                   | -                        | -                                | -                   | 2-1/4"  | 2"     | 1-1/2" <sup>(2)</sup> |
| ME503-16                | -                   | ME503A-16                | ME503S-16                        | -                   | 3-1/4"  | 2"     | -                     |
| ME503-20                | -                   | ME503A-20                | -                                | -                   | 3-1/4"  | 2-1/2" | -                     |
| ME262                   | -                   | ME262A                   | ME262S                           | -                   | 3-1/4"  | 3"     | -                     |
| ME504-24 <sup>(3)</sup> |                     |                          | ME524-24 <sup>(3)</sup>          |                     | 4-1/4"  | 3"     | -                     |



- (1) Rated for LP-Gas & NH<sub>3</sub>  
 (2) Male Thread Outside & Female Thread Inside  
 (3) Not a UL Listed Configuration  
 (4) "SS" Indicated Stainless Steel

NOTE: Pressure rated for 400 WOG

MEP502



MEP503K Installed  
(ME503-16 not included)



MEP503

| Part No. | Description   |
|----------|---|
| MEP502   | 1-3/4" M. Acme x 1-3/4" F. Acme Conical Filter Adapter                                    |
| MEP503   | Conical Filter Screen only for 3-1/4" M Acme Adapters 30 Mesh - Stainless Steel           |
| MEP503K  | Conical Filter Screen and Retainer for 3-1/4" M Acme Adapters - 30 Mesh - Stainless Steel |



| Part No. |         | M. Acme | M. Acme |
|----------|---------|---------|---------|
| Brass    | Steel * |         |         |
| ME270    | -       | 1-1/4"  | 1-1/4"  |
| ME273    | ME273S  | 1-3/4"  | 1-3/4"  |
| ME275    | ME275S  | 2-1/4"  | 2-1/4"  |
| ME277    | ME277S  | 3-1/4"  | 3-1/4"  |

\* Rated for LP-Gas & NH<sub>3</sub>

## ACME REDUCER COUPLINGS



| Part No. |         | F. Acme | M. Acme     |
|----------|---------|---------|-------------|
| Brass    | Steel * |         |             |
| ME611    | ME611S  | 2-1/4"  | 1-3/4"      |
| ME612    | ME612S  | 3-1/4"  | 1-3/4"      |
| ME614    | ME614S  | 3-1/4"  | 2-1/4"      |
| ME442    | ME442S  | 3-1/4"  | 1-1/4" FNPT |
| ME613**  | ME623** | 4-1/4"  | 3-1/4"      |

\* Rated for LP-Gas & NH<sub>3</sub>  
 \*\* Not a UL Listed Configuration  
 NOTE: Pressure rated for 400 WOG



# ACME CAPS

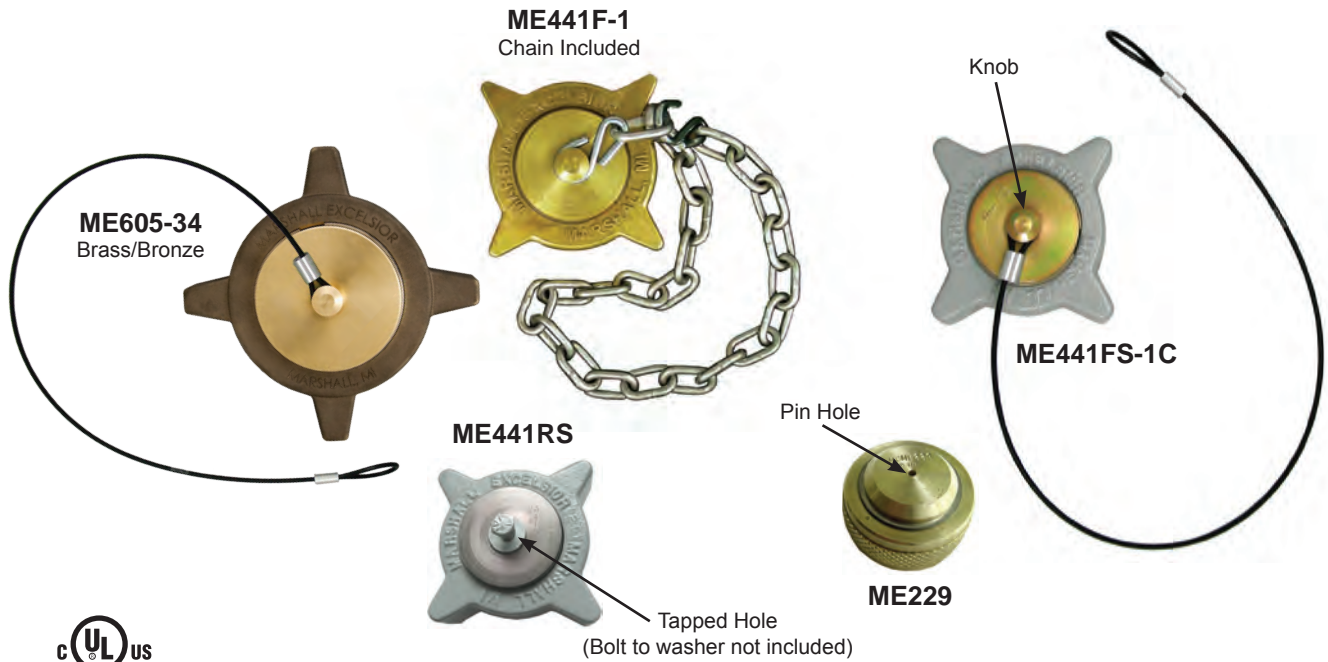

| Part No. |                |                |          |                |                | F. Acme | Style       | Accessories  |            |
|----------|----------------|----------------|----------|----------------|----------------|---------|-------------|--------------|------------|
| Brass    |                |                | Steel *  |                |                |         |             | Chain Only** | Cable Only |
| Cap Only | Cap with Chain | Cap with Cable | Cap Only | Cap with Chain | Cap with Cable |         |             |              |            |
| ME229    | ME229-1        | —              | ME229S   | ME229S-1       | —              | 1-3/4"  | Pin Hole    | MEP148       | —          |
| ME229F   | ME229F-1       | ME229F-1C      | ME229FS  | ME229FS-1      | ME229FS-1C     | 1-3/4"  | Knob        | MEP167       | MEP168     |
| ME431F   | ME431F-1       | ME431F-1C      | ME431FS  | ME431FS-1      | ME431FS-1C     | 2-1/4"  | Knob        | MEP167       | MEP168     |
| ME431R   | ME431R-1       | —              | —        | —              | —              | 2-1/4"  | Tapped Hole | MEP167       | —          |
| ME441F   | ME441F-1       | ME441F-1C      | ME441FS  | ME441FS-1      | ME441FS-1C     | 3-1/4"  | Knob        | MEP167       | MEP168     |
| ME441R   | ME441R-1       | —              | ME441RS  | ME441RS-1      | —              | 3-1/4"  | Tapped Hole | MEP167       | —          |
| —        | —              | ME605-34***    | —        | —              | ME625-34***    | 4-1/4"  | Knob        | —            | MEP168     |

NOTE: Red and Yellow versions available upon request  
Pressure rated for 400 WOG

\* Rated for LP-Gas & NH<sub>3</sub>

\*\* MEP147 ring fits over 3/4" MNPT—MEP148 ring fits over 1-1/4"

\*\*\* Not a UL Listed Configuration



ME106

| Part No.   |                | F. Acme | Style    | Accessory    |
|------------|----------------|---------|----------|--------------|
| Plastic    |                |         |          | Chain Only** |
| Cap Only   | Cap with Chain |         |          |              |
| ME108      | ME108-1        | 1-1/4"  | Pin Hole | MEP147       |
| ME109      | ME109-1        | 1-3/4"  | Pin Hole | MEP148       |
| ME109-NH3* | ME109-NH3-1*   |         |          |              |
| ME106      | ME106-1        | 3-1/4"  | Pin Hole | —            |



ME109-NH3

\* Rated for NH<sub>3</sub>

\*\* MEP147 ring fits over 3/4" MNPT—MEP148 ring fits over 1-1/4" MNPT

NOTE: Plastic caps are not for pressure - containing applications



# ACME CAPS WITH FLANGE

The flange allows for easy operation of pneumatic or proximity interlock switches which control the safety systems of transport vehicles. The stainless steel flange is flush mounted to the Acme cap.



ME441F8



| Part No.        |                         |                         |                 |                         |                         | F. Acme | Style       | Flange Diameter | Accessory  |            |
|-----------------|-------------------------|-------------------------|-----------------|-------------------------|-------------------------|---------|-------------|-----------------|------------|------------|
| Brass           |                         |                         | Steel *         |                         |                         |         |             |                 | Chain Only | Cable Only |
| Cap with Flange | Cap with Flange & Chain | Cap with Flange & Cable | Cap with Flange | Cap with Flange & Chain | Cap with Flange & Cable |         |             |                 |            |            |
| ME229F5         | ME229F5-1               | ME229F5-1C              | ME229FS5        | ME229FS5-1              | ME229FS5-1C             | 1-3/4"  | Knob        | 5"              | MEP167     | MEP168     |
| ME441F8         | ME441F8-1               | ME441F8-1C              | ME441FS8        | ME441FS8-1              | ME441FS8-1C             | 3-1/4"  | Knob        | 8"              | MEP167     | MEP168     |
| ME441R8         | ME441R8-1               | —                       | —               | —                       | —                       | 3-1/4"  | Tapped Hole | 8"              | MEP167     | MEP168     |

\* Rated for LP-Gas & NH<sub>3</sub>

NOTE: Pressure rated for 400 WOG

# HEAVY DUTY ACME SPANNER WRENCHES

EZ-Turn Ergonomic Aluminum Acme spanner wrench for 3-1/4" female Acme caps.

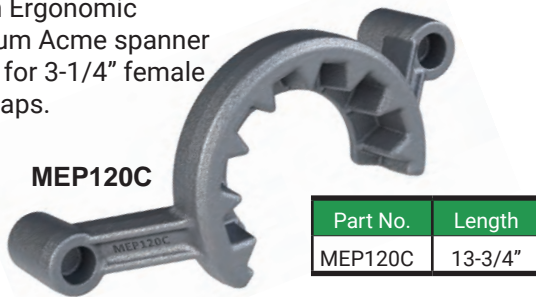

MEP120C

| Part No. | Length  |
|----------|---------|
| MEP120C  | 13-3/4" |

Aluminum Acme spanner wrench for 1-3/4", 2-1/4", 3-1/4" and 4-1/4" female Acme caps.

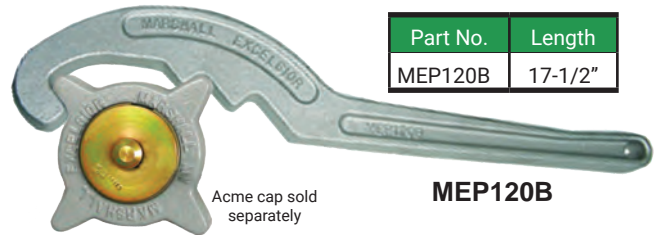

| Part No. | Length  |
|----------|---------|
| MEP120B  | 17-1/2" |

MEP120B

Acme cap sold separately

# ACME DUST PLUGS

| Part No.  |             |                 |           |             |                 |             |             |                 | M. Acme |
|-----------|-------------|-----------------|-----------|-------------|-----------------|-------------|-------------|-----------------|---------|
| Aluminum  |             |                 | Brass **  |             |                 | Plastic *** |             |                 |         |
| Plug Only | Chain Only* | Plug with Chain | Plug Only | Chain Only* | Plug with Chain | Plug Only   | Chain Only* | Plug with Chain |         |
| —         | —           | —               | ME178B    | MEP148      | ME178B-1        | ME178       | MEP147      | ME178-1         | 1-1/4"  |
| ME239     | MEP148      | ME239-1         | ME179B    | MEP148      | ME179B-1        | ME179       | MEP148      | ME179-1         | 1-3/4"  |
| —         | —           | —               | ME180B    | MEP167      | ME180B-1        | ME180       | MEP148      | ME180-1         | 2-1/4"  |
| —         | —           | —               | ME181B    | MEP167      | ME181B-1        | ME181       | MEP183      | ME181-1         | 3-1/4"  |

\* MEP147 ring fits over 3/4" MNPT—MEP148 ring fits over 1-1/4" MNPT

\*\* Brass plugs pressure rated for 400 WOG

\*\*\* Plastic plugs are not for pressure rated applications

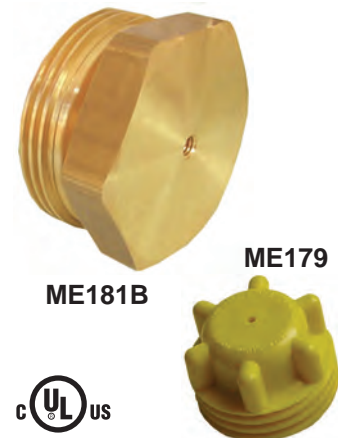



# WHEEL CHOCK

Designed with a "Double Grip" handle for easy carrying and dual traction grips for the road and tire. The cast aluminum construction makes the wheel chock lightweight while still able to withstand the toughest environments. Turn the wheel chock upside down and the points on top of the wheel chock will dig into the snow, ice and mud to prevent sliding. Durable safety yellow powder coat finish.

| Part No. | Height | Length | Width |
|----------|--------|--------|-------|
| ME200    | 7"     | 10"    | 7"    |



# WHEEL CHOCK BRACKET

Designed to provide a durable and convenient receptacle to store wheel chocks during over-the-road transit. Durable aluminum construction and molded inserts prevent damage to wheel chocks. For installations that require additional mounting clearance a standoff extension kit is available.



ME200BK

| Part No. | Height | Length | Depth | Wheel Chocks Included | Accessory              |
|----------|--------|--------|-------|-----------------------|------------------------|
|          |        |        |       |                       | Standoff Extension Kit |
| ME200B   | 7-3/4" | 20"    | 7"    | No                    | ME200EXT               |
| ME200BK  | 9-3/4" | 20"    | 8"    | Yes                   |                        |

# UNIVERSAL UTILITY BRACKET

Provides a safe and secure method to mount and retain hand tools such as shovels, picks, brooms or other equipment for bobtail or utility vehicles during over the road transit.

## FEATURES

- Cast aluminum body for maximum durability
- Vinyl coated for maximum security
- All stainless steel spring and mounting hardware

| Part No. | Description                             |
|----------|---|
| MEP082   | Universal Spring Loaded Utility Bracket |



MEP082



# CONTAINER THERMOMETERS

Designed for use in LP-Gas or NH<sub>3</sub> storage tanks, nurse tanks, bobtails and transports. These stainless steel, dust and water proof thermometers feature a 1/2" MNPT connection with a temperature range from -40° to +120° Fahrenheit. Accuracy +/- 1 percent full range.



| Part No. | Dial Diameter | Probe Length |
|----------|---------------|--------------|
| MEJ700   | 2"            | 4"           |
| MEJ701   | 2"            | 6"           |
| MEJ702   | 3"            | 4"           |
| MEJ703   | 3"            | 6"           |

# PRESSURE GAUGES

Designed to measure the pressure of gas or liquid. Marshall Excelsior offers two types of gauges, dry and glycerin filled. The dry gauge is the most commonly used and least expensive gauge. With a glycerin filled gauge, the life of the gauge is extended, vibration of the pointer is minimized and condensation, caused by humid air inside the gauge, is eliminated.

To determine the correct gauge, environment along with normal operating system pressure must be considered. The pressure range of the gauge should be twice the normal system pressure to maximize gauge life and accuracy.

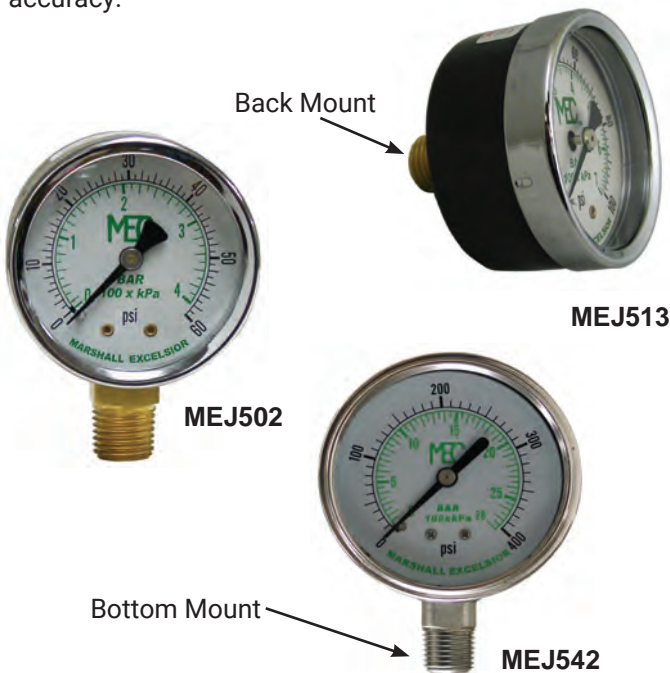

| Part No.               |                      | PSIG     | Dial Size | Fill Type |
|------------------------|----------------------|----------|-----------|-----------|
| 1/4" MNPT Bottom Mount | 1/4" MNPT Back Mount |          |           |           |
| MEJ520                 | —                    | 0-5      | 2-1/2"    | Dry       |
| MEJ500                 | MEJ510               | 0-15     | 2"        | Dry       |
| MEJ603LP-01*           | —                    | 0-15     | 2-1/2"    | Glycerin  |
| MEJ501                 | MEJ511               | 0-30     | 2"        | Dry       |
| ME10BTK-04             | —                    | 0-30     | 2-1/2"    | Glycerin  |
| ME50ECO-2              | —                    | 0-35" WC | 2-1/2"    | Dry       |
| MEJ502                 | MEJ512               | 0-60     | 2"        | Dry       |
| MEJ503                 | MEJ513               | 0-100    | 2"        | Dry       |
| MEJ504                 | —                    | 0-160    | 2"        | Dry       |
| MEJ505                 | —                    | 0-200    | 2"        | Dry       |
| MEJ600-02              | MEJ516               | 0-300    | 2"        | Dry       |
| MEJ603HP-01*           | —                    | 0-300    | 2-1/2"    | Glycerin  |
| MEJ580***              | —                    | 0-300    | 4"        | Dry       |
| MEJ542**               | —                    | 0-400    | 2-1/2"    | Glycerin  |
| —                      | MEJ524*              | 0-400    | 2-1/2"    | Glycerin  |
| MEJ552*                | MEJ526**             | 0-400    | 2-1/2"    | Glycerin  |

\* Brass Pipe Thread; Stainless Steel Bezel  
 \*\* Stainless Steel Gauge      \*\*\* Plated Steel Gauge

# PRESSURE GAUGE PROTECTIVE BOOT

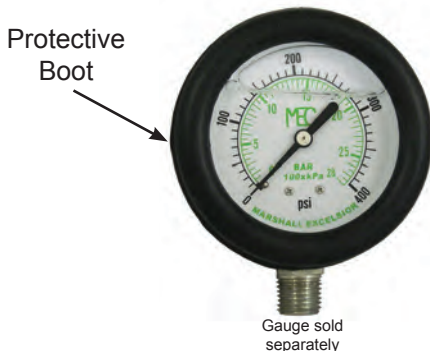

Designed to fit over the pressure gauge dial to extend the life and accuracy of dry and liquid pressure gauges. This boot helps protect the dry pressure gauge's fragile internal components and helps prevent dents on liquid pressure gauges which cause the gauge to leak.

| Part No. | Fits                                     |
|----------|--|
| MEJ2.5GB | 2-1/2" Dial, Bottom Mount Pressure Gauge |



# PRESSURE GAUGE SNUBBERS

Designed for a pressure gauge to be threaded into the outlet of the snubber. The snubber will reduce pressure fluctuations that can over pressurize or damage the gauge while maintaining a quick response time and a steady reading.

| Part No. | Material        | Style                      | Inlet (MNPT) | Outlet (FNPT) |
|----------|-----------------|----------------------------|--------------|---------------|
| ME202    | Brass           | #54 Orifice                | 1/4"         | 1/4"          |
| ME202SS  | Stainless Steel | #54 Orifice                | 1/4"         | 1/4"          |
| ME204    | Brass           | Sintered Metal Filter Disc | 1/4"         | 1/4"          |



ME202SS



ME204

# THERMAL FUSE PLUGS

MEC fuse plugs are designed to release when exposed to fire ranging from 212-250° F. Ideal for air controlled remote release air operated actuator systems.

| Part No.  | NTP      | Material | Hex   | OAL    |
|-----------|----------|----------|-------|--------|
| ME205-013 | 1/8" MPT | Brass    | 7/16" | .5906" |
| ME206-09  | 3/8" MPT | Brass    | 3/4"  | .75"   |



ME205-013

# SERVICEMAN'S REPLACEMENT SEAL KIT

Designed to provide a convenient storage system for all common LP-Gas and NH<sub>3</sub> gaskets and O-rings. Perfect for dispenser cabinets or bobtail and transport drivers.

## FEATURES

- Durable ABS plastic container with storage latch
- Preformed insert with individual spaces for each gasket/O-ring size
- Labeled with each gasket/O-ring size and part number for easy identification and reorder purposes
- All gaskets/O-rings manufactured from UL approved compounds for LP-Gas and NH<sub>3</sub> services



MEW1

| MEW1—Serviceman's Replacement Seal Kit Includes: | Qty | Replacement Part No. |
|--|-----|----------------------|
| 1-1/4" Acme Motor Fuel Flat Gasket               | 9   | MEW4                 |
| 1-1/4" Acme Flat Gasket                          | 10  | MEW3                 |
| 1-3/4" Acme Flat Gasket                          | 10  | MEW2                 |
| 2-1/4" Acme Flat Gasket                          | 10  | MEW5                 |
| 3-1/4" Acme Flat Gasket                          | 10  | MEW6                 |
| Male Motor Fuel Connector O-ring                 | 12  | ME220M-02            |
| POL O-ring                                       | 12  | 568-110-01           |



MEW1 Layout



# HOSE REEL CONTROL SWITCH COVERS

These covers are intended to protect Hannay® Hose Reel Control Switches from moisture and/or other contaminants during over-the-road transit. The MEP-GMC1 is specifically designed to fit Hannay® Guidemaster® control switches while the MEP-RDC1 is specifically designed to fit Hannay® red DOT EPS style control switches. Both of these covers fit snugly over the control to help prevent damage due to moisture or other contaminants thereby increasing the longevity of the control switch.

## FEATURES

- Made with durable UV stable black low temperature EPDM material
- Includes security lanyard to help prevent loss of the cap
- Fits Hannay® Guidemaster® and red DOT EPS switches
- Control switch can be operated through cover without removing



MEP-RDC1

| Part No. | Description   | Material   |
|----------|---|------------|
| MEP-GMC1 | Hose Reel Control Switch Cover for Guidemaster® Control Arm | Black EPDM |
| MEP-RDC1 | Hose Reel Control Switch Cover for Red DOT EPS              | Black EPDM |

"Hannay®" and "Guidemaster®" are trademarks of Hannay Reels

# LED 12V LIGHT STRIP

Universal LED Light Strip can be installed anywhere to provide extra lighting right where you need it.

## FEATURES

- Bright White LED
- Pre-Applied 3M Adhesive backing for easy installation
- Can be cut to any length



| Part No.  | Description     |
|-----------|-----------------|
| MEP104-95 | LED Light Strip |

# NEEDLE VALVES

Intended for application where precise control of gas output is required. These precision machined valves offer a wide range of adjustment without stem galling. Perfect for isolating pressure gauges from bulk storage containers or upstream shutoff valves for torches and/or outdoor burner applications.

## FEATURES

- Available in brass, plated steel & stainless steel construction
- Tapered valve body seat & stem for precision accuracy
- Various inlet / outlet configurations available
- ME831 & ME834 series valves approved for bi-directional flow
-  LISTED for use with LP Gas and Anhydrous Ammonia - 400 PSI WOG

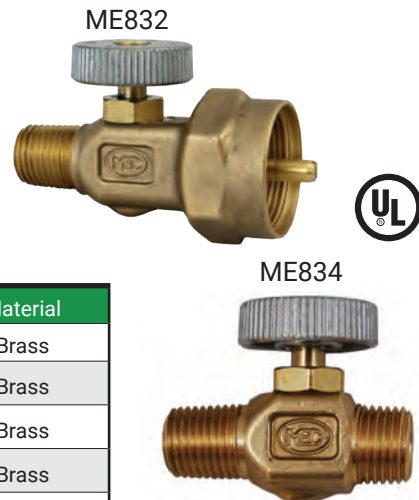

| Part No. | Description   | Material        |
|----------|---|-----------------|
| ME831    | Needle Valve 1/4" MNPT x 1/4" FNPT                          | Brass           |
| ME832    | Needle Valve 1/4" MNPT Outlet x #80 Orifice 1"- 20 F. Inlet | Brass           |
| ME833    | Needle Valve 1/4" MNPT Outlet x 1"- 20 F. Inlet             | Brass           |
| ME834    | Needle Valve 1/4" MNPT x 9/16" -18 LH Male                  | Brass           |
| ME831SS  | Needle Valve 1/4" MNPT x 1/4" FNPT                          | Stainless Steel |



# VENT VALVES

Marshall Excelsior is the only manufacturer in the industry that offers three types of vent valves—Low Emission, Self-Cleaning Low Emission, and Standard Vent Valves. All the vent valves below are designed to minimize loss of product while allowing the operator to effectively bleed down connections and detect liquid levels while filling containers. Vent valves provide an effective means to verify valves have closed in the transfer system when installed into the downstream auxiliary port on the Marshall Excelsior globe and angle valves. Opening the vent valve until liquid or vapor stops venting indicates it is safe to disconnect.

All brass versions have knurled stems that completely unscrew from the valve making the stems replaceable. The stainless steel version has a t-handle stem that is non-removable.

The Low Emission Vent Valve and the Self-Cleaning Low Emission Vent Valve reduce emissions by 70 Percent during normal container filling operations. The Self-Cleaning Low Emission Vent Valve cleans out the orifice hole each time it is operated. The hole is cleaned out with a #54 orifice drill that reams the valve's orifice hole each time the adjusting screw is loosened or tightened, eliminating nuisance orifice clogging. The reduced venting emissions is achieved by forcing product to pass between the #54 orifice hole and the flutes of the captured self-cleaning apparatus. The self-cleaning replacement screw (MEJ401SC) is compatible with all existing standard vent valve bodies allowing a standard vent valve to be converted into a self-cleaning low emission vent valve without reinstalling the valve body. The Standard Vent Valve has a #54 orifice with no self-cleaning apparatus.

| Type                                   | Part No.                    |                              |                                |
|--|-----------------------------|------------------------------|--------------------------------|
|  | Brass                       | Brass Replacement Stems      | Stainless Steel <sup>(1)</sup> |
| Low Emission #72 Orifice               | MEJ400/72                   | MEJ401                       | —                              |
| Self-Cleaning Low Emission #54 Orifice | MEJ400SC                    | MEJ401SC                     | —                              |
| Standard #54 Orifice                   | MEJ400                      | MEJ401<br>MEJ401SC           | MEJ402S <sup>(2)</sup>         |
| Standard #54 Orifice                   | MEJ400C <sup>(2)</sup>      | —                            | —                              |
| 90° Elbow w/ Hydrostatic Relief        | MEJ602H <sup>(3)</sup>      | —                            | —                              |
| 90° Elbow 1/4" MPT x 1/4" M. Flare     | MEJ606                      | MEJ400<br>MEJ401<br>MEJ401SC | —                              |
| 1/4" MNPT X 1/4" M. Flare              | MES-PVE10ARF <sup>(2)</sup> | —                            | —                              |

(1) Rated for LP-Gas & NH<sub>3</sub>

(2) Includes captured stem

(3) Factory installed hydrostatic relief valve

## FEATURES

- 70% emission reduction with our Self-Cleaning and Low Emission vent valves
- 1/4" MNPT Connection
- Available with dip tubes. See fixed maximum liquid level gauges

Self-Cleaning



MEJ400SC

PATENT #8,025,075

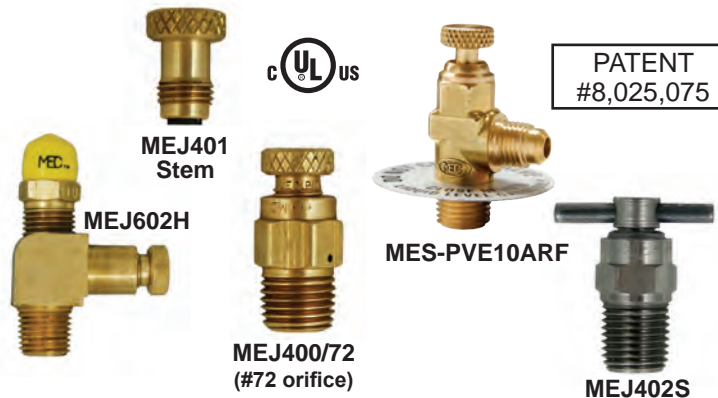

## FIXED MAXIMUM LIQUID LEVEL GAUGES

Designed to provide a way to visually determine that a tank has reached maximum allowable fill capacity. The dip tube end of a fixed liquid level gauge should be set equal to 80% of the liquid level tank capacity and installed in the vapor space of the tank. The vent valve should be opened before filling begins during which time vapor will be discharged. Once the tank reaches maximum liquid fill capacity (80% of tank capacity), liquid will begin to discharge from the vent valve telling the operator the tank has reached maximum allowable fill capacity and the filling operation should cease immediately.

| Type                                   | Part No.                   |                        |                        |                        |                       |  |
|--|----------------------------|------------------------|------------------------|------------------------|-----------------------|--|
|  | 5.4" Tube Length Brass     | 5.7" Tube Length Brass | 6.6" Tube Length Brass | 6.9" Tube Length Brass | 12" Tube Length Brass | 12" Tube Length Stainless Steel <sup>(1)</sup> |
| Low Emission #72 Orifice               | MEJ410/72-5.4              | MEJ410/72-5.7          | MEJ410/72-6.6          | MEJ410/72-6.9          | MEJ410/72-120         | —  |
| Self-Cleaning Low Emission #54 Orifice | MEJ410SC-5.4               | MEJ410SC-5.7           | MEJ410SC-6.6           | MEJ410SC-6.9           | MEJ410SC-120          | —  |
| #54 Orifice                            | MEJ410-5.4                 | MEJ410-5.7             | MEJ410-6.6             | MEJ410-6.9             | MEJ410-120            | MEJ402S-120 <sup>(2)</sup>                     |
| Captured Stem #54 Orifice              | MEJ410C-5.4 <sup>(2)</sup> | MEJ410C-5.7            | MEJ410C-6.6            | MEJ410C-6.9            | MEJ410C-120           | —  |



(1) Rated for LP-Gas & NH<sub>3</sub>

(2) Includes captured stem



# LIQUID TRANSFER VALVES

Designed to provide a safe means to transfer liquid or vapor from a storage container. ME449 Series valves can be directly installed for full time use in the liquid or vapor port of the storage container when configured with an integral excess flow check (ME449EXS Series, ME449X/19.5), or when utilized in conjunction with a Liquid Withdrawal Tank Valve with integral excess flow protection (ME460 or ME462 Series) and the appropriate Liquid Withdrawal Adapter (ME458 Series).

These valves can also be used for temporary liquid withdrawal applications such as emergency evacuations or container relocation, when utilized in conjunction with a Liquid Withdrawal Tank Valve featuring integral excess flow protection (ME460 or ME462 Series) installed directly into a container liquid withdrawal port and the appropriate Liquid Withdrawal Adapter (ME458 Series) installed onto the ME449 Series Liquid Withdrawal Transfer Valve connected to the delivery truck or service truck transfer hose.

Additionally, these valves can be used for a wide variety of other applications, including in-line use, as they meet the requirements of UL 125 – Flow Control Valves.

## Opening Liquid Withdrawal Tank Valve

1. Slowly loosen cap to release any trapped LP-Gas thru relief hole. Remove the cap when venting stops. In case of a leak and venting does not stop, retighten the cap and use another approved method to withdraw the liquid. When loosening the cap make sure the valve is not unthreading from the tank. Use two wrenches, if necessary, to secure the valve to the tank.
2. The Liquid Transfer Shutoff Valve must be in the open position and securely attached to the Liquid Withdrawal Adapter before connecting to the Liquid Withdrawal Tank Valve.
3. Once the Shutoff Valve Assembly is tightly attached to the Tank Valve, close the Shutoff Valve Assembly. A popping sound actuating the Tank Valve will occur while closing the Shutoff Valve Assembly allowing the flow to be controlled by the Shutoff Assembly. If the Tank Valve does not open after following steps 1-3, increase pressure downstream (Shutoff Valve side) to equalize pressure in the Tank Valve.
4. Use Marshall Excelsior Leak Detector to check for leaks between each connection.

## Closing Liquid Withdrawal Tank Valve

1. To shut the Tank Valve pressure in the tank must exceed 35 psig. Close the Shutoff Valve Assembly and disconnect the hose or piping.
2. Slowly open the Shutoff Valve Assembly to release any LP-Gas in the valve. If the tank pressure exceeds 35 psig the LP-Gas released to the air will cause the excess flow feature to close on the Tank Valve. If the Tank Valve does not completely shut, close the Shutoff Valve Assembly immediately. The Shutoff Valve Assembly must remain connected until all the LP-Gas can be removed and the container repaired.
3. After the Tank Valve excess flow feature has closed remove the Shutoff Valve Assembly. When disconnecting the assembly make sure the Tank Valve is not unthreading from the tank. Use two wrenches, if necessary, to secure the valve to the tank. Note: A small amount of bypass may occur through the excess flow check. Use caution when removing the Shutoff Valve Assembly.
4. Clean the top surface of the Tank Valve and place Tank Valve Cap back onto Tank Valve ensuring cap gasket is in place. Make sure the Tank Cap is placed tightly onto the Tank Valve.

NOTE: Always use an adapter between the liquid transfer valve (ME449 Series) and the liquid withdrawal valve. Extreme care must be used whenever liquid transfer of LP-Gas is in progress. Only persons trained in the proper method of transfer should attempt this type of operation. Reference NFPA #58 Liquefied Petroleum Gas Code Chapter 7, LP-Gas Liquid Transfer for additional information.

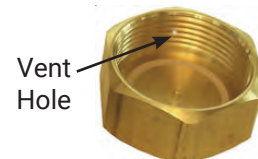
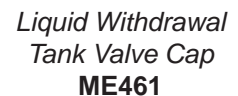

# LIQUID TRANSFER VALVES & ADAPTERS

Designed to provide a safe means to transfer liquid or vapor from a storage container. ME449 Series valves can be directly installed for full time use in the liquid or vapor port of the storage container when configured with an integral excess flow check (ME449EXS Series, ME449X/19.5), or when utilized in conjunction with a Liquid Withdrawal Tank Valve with integral excess flow protection (ME460 or ME462 Series) and the appropriate Liquid Withdrawal Adapter (ME458 Series).

These valves can also be used for temporary liquid withdrawal applications such as emergency evacuations or container relocation, when utilized in conjunction with a Liquid Withdrawal Tank Valve featuring integral excess flow protection (ME460 or ME462 Series) installed directly into a container liquid withdrawal port and the appropriate Liquid Withdrawal Adapter (ME458 Series) installed onto the ME449 Series Liquid Withdrawal Transfer Valve connected to the delivery truck or service truck transfer hose.

Additionally, these valves can be used for a wide variety of other applications, including in-line use, as they meet the requirements of UL 125 – Flow Control Valves.



ME450

## LIQUID TRANSFER VALVE FEATURES

- Double O-ring stem seal design ensures leak free operation
- Double lead stem thread ensures quick and efficient operation
- 3/4" MNPT inlet x 3/4" FNPT outlet
- Additional features for steel transfer valves
  - All stainless steel internal components
  - Durable ductile iron valve body with automotive grade powder coat finish
- Equipped with convenient upstream and downstream 1/4" FNPT plugged ports for optional accessories



MEP449S-101  
Replacement  
Protective  
Weather Boot

ME449EXSS/22



ME449X/19.5



ME449X-110-KIT

## TANK VALVE FEATURES

- Provides excess flow protection in the event of a downstream connection or line failure
- Safety breakaway feature leaves valve seals intact in the event of truck roll-away
- 6-14 psig closing flow pressure differential for maximum product transfer
- Fully interchangeable with all existing valve models and adapters
- Additional features for steel and stainless steel tank valves
  - Meets requirements for installation into DOT storage containers like bobtails and transports
  - Steel model features a rust inhibitor compound between the cap and body threads to prevent corrosion



ME462S

| Part No.             | Material                       | Excess Flow | Closing Flow/ GPM | Accessories                                      |                      |  |                      |                       |                        | Hydrostatic Relief Valve                   | Vent Valve     | Excess Flow Check Valve |
|----------------------|--------------------------------|-------------|-------------------|--|----------------------|--|----------------------|-----------------------|------------------------|--|----------------|-------------------------|
|                      |                                |             |                   | Liquid Withdrawal Adapter 3/4" FNPT x 1-5/8" UNF |                      | Liquid Withdrawal Tank Valve 1-5/8" UNF Male |                      |                       |                        |  |                |                         |
|                      |                                |             |                   | Brass  | Steel <sup>(1)</sup> | 3/4" MNPT                                    | 1-1/4" MNPT          |                       |                        |  |                |                         |
|                      |                                |             |                   |  |                      |  | Brass                | Brass                 | Steel <sup>(1)</sup>   |  |                |                         |
| ME449                | Brass                          | No          | –                 | ME458  | ME458S               | ME460 <sup>(3)</sup>                         | ME462 <sup>(3)</sup> | –                     | –                      | MEH225<br>MEH25/450                        | ME449X-110-KIT |                         |
| ME449H               | Brass                          | No          | –                 | ME458  | ME458S               | –  | –                    | –                     | –                      | Factory Installed<br>MEH225                |                |                         |
| ME449S               | Ductile Iron <sup>(1)</sup>    | No          | –                 | –  | ME458S               | –  | –                    | ME462S <sup>(3)</sup> | ME462SS <sup>(3)</sup> | –  | –              |                         |
| ME449SS              | Stainless Steel <sup>(1)</sup> | No          | –                 | –  | ME458S               | –  | –                    | ME462S <sup>(3)</sup> | ME462SS <sup>(3)</sup> | –  | –              |                         |
| ME449EXS/22          | Ductile Iron <sup>(1)</sup>    | Yes         | 22                | –  | –                    | –  | –                    | –                     | –                      | MEJ400<br>MEJ400SC<br>MEJ400/72<br>MEJ402S | –              |                         |
| ME449EXSS/22         | Stainless Steel <sup>(1)</sup> | Yes         | 22                | –  | –                    | –  | –                    | –                     | –                      | –  | –              |                         |
| ME449EXS/28          | Ductile Iron <sup>(1)</sup>    | Yes         | 28                | –  | –                    | –  | –                    | –                     | –                      | –  | –              |                         |
| ME449EXSS/28         | Stainless Steel <sup>(1)</sup> | Yes         | 28                | –  | –                    | –  | –                    | –                     | –                      | –  | –              |                         |
| ME449X/19.5          | Brass                          | Yes         | 19.5              | –  | –                    | –  | –                    | –                     | –                      | –  | ME449X-110-KIT |                         |
| ME450 <sup>(2)</sup> | Brass                          | No          | –                 | –  | –                    | ME601-6                                      | ME601-10             | –                     | –                      | –  | –              |                         |

(1) Rated for LP-Gas & NH<sub>3</sub>

(2) MEJ400 Vent Valve Factory Installed

(3) Includes an excess flow feature (ME460 = 21 GPM / ME462 = 36 GPM)



**WARNING:** An excess flow valve will not activate if there is a break or leak downstream of the valve that does not equal or exceed the closing flow of the valve or if the excess flow valve installed exceeds the flow capacity of the system. See the Excess Flow Warning page for more information regarding the use of excess flow devices.

# LIQUID TRANSFER ADAPTERS

Designed for use between the liquid transfer shutoff valve and the liquid withdrawal tank valve. These adapters enable the tank valve to open properly and allows a tight seal when transferring liquid. Special threads on the tank valve and the adapter help eliminate tampering.

The ME458 Series fits all new underwriters laboratories listed valves. The ME453 and ME455 fit older style liquid withdrawal tank valves that are still in service and have not been replaced. They will not provide a positive seal during actuation of liquid withdrawal tank valve until fully seated.

| Part No. | Material | Inlet Connection | Outlet Connection |
|----------|----------|------------------|-------------------|
| ME458    | Brass    | 1-5/8" UNF       | 3/4" FNPT         |
| ME458S*  | Steel    | 1-5/8" UNF       | 3/4" FNPT         |
| ME453    | Brass    | 3/4" NGT         | 3/4" FNPT         |
| ME455    | Brass    | 3/4" NGT         | 3/4" MNPT         |

\* Rated for LP-Gas & NH<sub>3</sub>



# COMBINATION VALVES

Developed to mount a pressure gauge and fixed tube liquid level gauge all in one valve. The shutoff portion of the valve increases the pressure gauge's life and accuracy by eliminating constant gauge pressure and allows for easy gauge replacement. To replace a gauge simply close the valve and open the vent valve to relieve pressure before disassembling pressure gauge.

The valve can be installed at the maximum fill level or an 1/8" MNPT dip tube can be installed on the container connection side to set any liquid level desired. For use in ASME bulk storage containers and DOT transport tank installations.

Additionally, these valves can be used for a wide variety of other applications, including in-line use, as they meet the requirements of UL 125 – Flow Control Valves.

## FEATURES

- All steel and stainless steel component construction
- Integral #54 orifice provides gauge dampening protection
- Durable ductile iron body with automotive grade powder coat finish or plated steel body

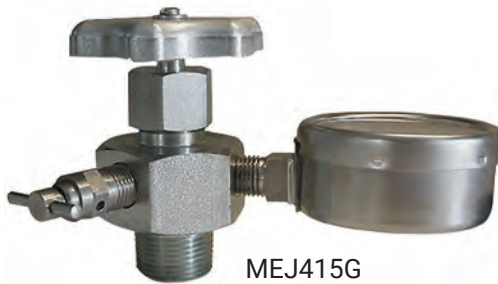

MEJ415G



For LP-Gas & NH<sub>3</sub>

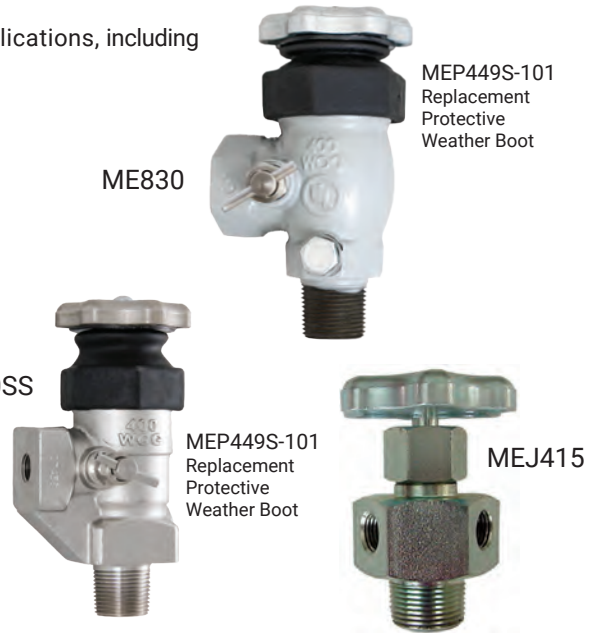

ME830

MEP449S-101 Replacement Protective Weather Boot

ME830SS

MEP449S-101 Replacement Protective Weather Boot

MEJ415

| Part No. | Material        | Container Connection MNPT | Service Connections FNPT | Dip Tube Connection FNPT | Orifice      | Accessories                |   |
|----------|-----------------|---------------------------|--------------------------|--------------------------|--------------|----------------------------|---|
|          |                 |                           |                          |                          |              | Stainless Steel Vent Valve | Stainless Steel 0-400 PSIG Pressure Gauge |
| ME830    | Ductile Iron    | 3/4" MNPT                 | 1/4" FNPT (1)            | 1/8"                     | .062"        | Included                   | MEJ526<br>MEJ542                          |
| ME830SS  | Stainless Steel | 3/4" MNPT                 | 1/4" FNPT (1)            | 1/8"                     | .062"        | Included                   | MEJ526<br>MEJ542                          |
| MEJ415   | Steel           | 3/4" MNPT                 | 1/4" FNPT (2)            | 1/4"                     | #55 (0.025") | MEJ402S                    | MEJ542                                    |
| MEJ415G  | Steel           | 3/4" MNPT                 | 1/4" FNPT (2)            | 1/4"                     | #55 (0.025") | Included                   | Included                                  |





# LIFT TRUCK FLOAT GAUGE

for DOT HORIZONTAL or VERTICAL TANK ORIENTATION

## FEATURES

- 1-1/4" NPT or junior head mounting
- Refer to ordering information for correct gauge
- Junior mounting head includes gasket
- Solid brass mounting head - **LPG SERVICE ONLY**
- Ultra low friction, smooth acting, non-jamming gear design
- Hermetically sealed, easy to read dial
- PTFE coated, free-floating shaft
- Solid float; no metal shell to corrode or leak
- Pre-applied thread sealant on NPT versions

**MES-FG1284-001U**  
Lift Truck Float Gauge  
(Junior Head Mounting)



**MES-FG2284-001U**  
Lift Truck Float Gauge  
(1-1/4 NPT Mounting)

| Part No.        | Propane Capacity and Mounting Style | Nominal Cylinder Diameter | Gauge Head Style               | Replacement Dial w/ 2 Mounting Screws |
|-----------------|-------------------------------------|---------------------------|--------------------------------|---------------------------------------|
| MES-FG1284-001U | 33-1/2 lb. universal                | 12"                       | Junior Brass Head              | MES-1284-20-001-KIT                   |
| MES-FG2184-001U | 33-1/2 lb. universal                | 12"                       | Threaded 3/4" NPT Brass Head   | MES-2184-20-001-KIT                   |
| MES-FG2284-001U | 33-1/2 lb. universal                | 12"                       | Threaded 1-1/4" NPT Brass Head | MES-1284-20-001-KIT                   |

# 1" NPT ABOVE GROUND FLOAT GAUGES

for ASME ABOVE GROUND HORIZONTAL DOMESTIC TANKS & DOT CYLINDERS

## FEATURES

- REMOTE READY
- 1" NPT mounting
- Refer to ordering information for correct size gauge
- For various size tanks
- Solid brass mounting head - **LPG SERVICE ONLY**
- Ultra low friction, smooth acting, non-jamming gear design
- Hermetically sealed, easy to read dial
- PTFE coated, free-floating shaft
- Solid float; no metal shell to corrode or leak



**MES-FG3981 Series**  
1" NPT AG Float Gauges

| Part No.        | Container Capacity (Gallons of Water) | Nominal Cylinder Diameter | Gauge Head Style           | Remote Ready Replacement Dial w/ 2 Mounting Screws | Standard Replacement Dial w/ 2 Mounting Screws |
|-----------------|---------------------------------------|---------------------------|----------------------------|--|--|
| MES-FG3981-002R | 120, 150                              | 24"                       | Threaded 1" NPT Brass Head | MES-1284-20-002R-KIT                               | MES-1284-20-002-KIT                            |
| MES-FG3981-003R | 200, 250, 325                         | 30"                       |                            | MES-1284-20-002R-KIT                               | MES-1284-20-002-KIT                            |
| MES-FG3981-004R | 500                                   | 37"                       |                            | MES-1284-20-002R-KIT                               | MES-1284-20-002-KIT                            |
| MES-FG3981-005R | 1000                                  | 41"                       |                            | MES-1284-20-002R-KIT                               | MES-1284-20-002-KIT                            |
| MES-FG3981-001R | 420# vertical                         | 30"                       |                            | MES-1284-20-003R-KIT (% of total volume)           | -  |



# 1-1/4" ABOVE GROUND FLOAT GAUGES

for ABOVE GROUND HORIZONTAL DOMESTIC TANKS

## FEATURES

- REMOTE READY
- 1-1/4" NPT mounting
- Refer to ordering information for correct size gauge
- For various size tanks
- Solid brass mounting head - **LPG SERVICE ONLY**
- Ultra low friction, smooth acting, non-jamming gear design
- Hermetically sealed, easy to read dial
- PTFE coated, free-floating shaft
- Solid float; no metal shell to corrode or leak



MES-FG2281 Series 

| Part No.        | Container Capacity (Gallons of Water) | Nominal Cylinder Diameter | Gauge Head Style               | Remote Ready Replacement Dial w/ 2 Mounting Screws | Standard Replacement Dial w/ 2 Mounting Screws |
|-----------------|---------------------------------------|---------------------------|--------------------------------|--|--|
| MES-FG2281-001R | 120, 150                              | 24"                       | Threaded 1-1/4" NPT Brass Head | MES-1284-20-002R-KIT                               | MES-1284-20-002-KIT                            |
| MES-FG2281-002R | 200, 250, 325                         | 30"                       | Threaded 1-1/4" NPT Brass Head | MES-1284-20-002R-KIT                               | MES-1284-20-002-KIT                            |
| MES-FG2281-003R | 500                                   | 37"                       | Threaded 1-1/4" NPT Brass Head | MES-1284-20-002R-KIT                               | MES-1284-20-002-KIT                            |
| MES-FG2281-004R | 1000                                  | 41"                       | Threaded 1-1/4" NPT Brass Head | MES-1284-20-002R-KIT                               | MES-1284-20-002-KIT                            |

# JUNIOR ABOVE GROUND FLOAT GAUGES

for ASME ABOVE GROUND HORIZONTAL DOMESTIC TANKS

## FEATURES

- REMOTE READY
- Brass junior head mounting
- Refer to ordering information for correct size gauge
- Gasket included
- Solid brass mounting head - **LPG SERVICE ONLY**
- Ultra low friction, smooth acting, non-jamming gear design
- Hermetically sealed, easy to read dial
- PTFE coated, free-floating shaft
- Solid float; no metal shell to corrode or leak
- Standard with remote ready dial



 US

MES-FG1280 SERIES

| Part No.        | Container Capacity (Gallons of Water) | Nominal Cylinder Diameter | Remote Ready Replacement Dial w/ 2 Mounting Screws | Standard Replacement Dial w/ 2 Mounting Screws |
|-----------------|---------------------------------------|---------------------------|--|--|
| MES-FG1280-001R | 120, 150                              | 24"                       | MES-1284-20-002R-KIT                               | MES-1284-20-002-KIT                            |
| MES-FG1280-002R | 200, 250, 325                         | 30"                       | MES-1284-20-002R-KIT                               | MES-1284-20-002-KIT                            |
| MES-FG1280-003R | 500                                   | 37"                       | MES-1284-20-002R-KIT                               | MES-1284-20-002-KIT                            |
| MES-FG1280-004R | 1000                                  | 41"                       | MES-1284-20-002R-KIT                               | MES-1284-20-002-KIT                            |
| MES-FG1280-005R | 1999                                  | 47"                       | MES-1284-20-002R-KIT                               | MES-1284-20-002-KIT                            |
| MES-FG1280-006R | 2000                                  | 52"                       | MES-1284-20-002R-KIT                               | MES-1284-20-002-KIT                            |



# JUNIOR UNDERGROUND FLOAT GAUGES

## for UNDERGROUND HORIZONTAL DOMESTIC TANKS



**MES-FG1281 SERIES**  
Junior UG Float Gauges

### FEATURES

- Solid brass junior mounting head - **LPG SERVICE ONLY**
- Ultra low friction, smooth acting, non-jamming gear design
- Hermetically sealed, easy to read dial
- PTFE coated, free-floating shaft
- Solid float; no metal shell to corrode or leak
- REMOTE READY
- Refer to ordering information for correct size gauge
- Gasket included

| Part No.        | Container Capacity (Gallons of Water) | Nominal Cylinder Diameter | Gauge Head Style  | Gauge Riser Lengths  | Remote Ready Replacement Dial w/ 2 Mounting Screws | Standard Replacement Dial w/ 2 Mounting Screws |
|-----------------|---------------------------------------|---------------------------|-------------------|----------------------|--|--|
| MES-FG1281-001R | 120                                   | 24"                       | Junior brass head | 8-1/2"               | MES-1284-20-002R-KIT                               | MES-1284-20-002-KIT                            |
|                 | 150                                   |                           |                   |                      |  |  |
| MES-FG1281-002R | 200                                   | 30"                       |                   | 8-1/2"               | MES-1284-20-002R-KIT                               | MES-1284-20-002-KIT                            |
|                 | 250                                   |                           |                   |                      |  |  |
|                 | 325                                   |                           |                   |                      |  |  |
| MES-FG1281-003R | 500                                   | 37"                       |                   | 8-1/2"               | MES-1284-20-002R-KIT                               | MES-1284-20-002-KIT                            |
| MES-FG1281-004R | 1000                                  | 41"                       |                   | 8-1/2"               | MES-1284-20-002R-KIT                               | MES-1284-20-002-KIT                            |
| MES-FG1281-005R | 120                                   | 24"                       |                   | 15-1/2"              | MES-1284-20-002R-KIT                               | MES-1284-20-002-KIT                            |
|                 | 150                                   |                           |                   |                      |  |  |
| MES-FG1281-006R | 200                                   | 30"                       |                   | 15-1/2"              | MES-1284-20-002R-KIT                               | MES-1284-20-002-KIT                            |
|                 | 250                                   |                           |                   |                      |  |  |
|                 | 325                                   |                           |                   |                      |  |  |
| MES-FG1281-007R | 500                                   | 37"                       | 15-1/2"           | MES-1284-20-002R-KIT | MES-1284-20-002-KIT                                |  |



# ACCU-MAX™ FLOAT GAUGES

## HORIZONTAL MOUNT SERIES

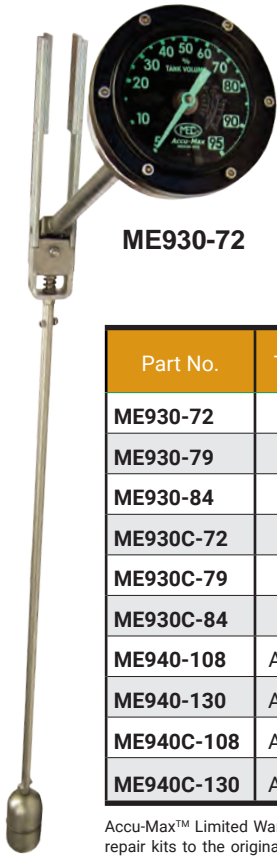

ME930-72

Designed to measure liquid levels within horizontal DOT and Stationary ASME Tanks with fluid capacities above 2,300 gallons. For maximum gauge life, the float arm features an integral spring loaded shock absorber for harsh over-the-road applications. The standard dial face features a black background for reduced glare with glow technology providing an easy to read "glow in the dark" dial face, perfect for low light situations. An optional classical style dial face is available. These gauges are suitable for use in bobtail, transport, railcar and bulk storage applications.

NOTE: These gauges must be installed on the centerline of the tank's side or end for accurate readings.

| Part No.   | Type | Style    | Dial Face    | Dial Size | Tank Diameter |
|------------|------|----------|--------------|-----------|---------------|
| ME930-72   | DOT  | Standard | Glow/Black   | 4"        | 72"           |
| ME930-79   | DOT  | Standard | Glow/Black   | 4"        | 79"           |
| ME930-84   | DOT  | Standard | Glow/Black   | 4"        | 84"           |
| ME930C-72  | DOT  | Classic  | Silver/Black | 4"        | 72"           |
| ME930C-79  | DOT  | Classic  | Silver/Black | 4"        | 79"           |
| ME930C-84  | DOT  | Classic  | Silver/Black | 4"        | 84"           |
| ME940-108  | ASME | Standard | Glow/Black   | 8"        | 108"          |
| ME940-130  | ASME | Standard | Glow/Black   | 8"        | 130"          |
| ME940C-108 | ASME | Classic  | Silver/Black | 8"        | 108"          |
| ME940C-130 | ASME | Classic  | Silver/Black | 8"        | 130"          |

Accu-Max™ Limited Warranty: Marshall Excelsior warrants Accu-Max™ float gauges and repair kits to the original buyer to be free of defects in material and workmanship under normal service and use for two years from manufactured date.

### FEATURES

- All stainless steel construction
- Welded tube to coupling design for maximum strength and durability
- Dial face 100% sealed and argon filled to prevent moisture build-up & fogging
- Factory set and precision tuned for superb accuracy
- Dial face and mounting hardware universal with other industry standard gauges
- Mounts to all standard 8 bolt tank flange adapters
- Custom length tank configurations available upon request for 30" to 300" I.D. tank

PATENT  
#D671,022  
#D666,933



"Glow" Technology  
Standard Dial



ME940 ASME Series / 8" Dial  
Shown as Standard "Glow" Dial



ME930C DOT Series / 4" Dial  
Shown as Classic Dial

## ACCESSORIES

Designed for mounting float gauges in DOT or ASME tanks. These zinc plated steel 8 bolt mounting flanges feature 1/2"-13 threads for easy installation.

| Part No. | Connection  | Connection     | Installation Tool |
|----------|-------------|----------------|-------------------|
| ME931    | 2-1/2" MNPT | 1/2"-13 Female | MEP930WG          |
| ME932*   | Weld        | 1/2"-13 Female | —                 |

\*Weld flanges supplied with material certification



ME932



ME931



# ACCU-MAX™ FLOAT GAUGES

## TOP MOUNT SERIES

Measure liquid levels within horizontal Stationary ASME Tanks with fluid capacities above 2,300 gallons. Suitable for use in bulk storage vessels equipped with either 2-1/2" NPT 6000 lb. or 8 bolt 3-1/2" on center tank openings located on the top of the vessel such as underground or buried applications.

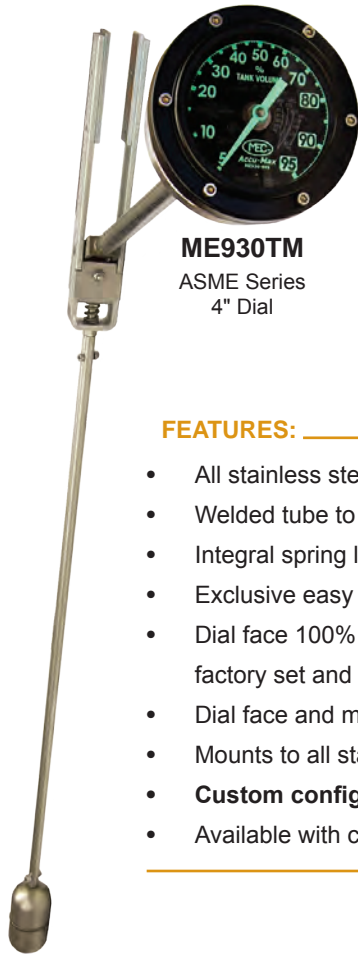

**ME930TM**  
ASME Series  
4" Dial



**ME940TM**  
ASME Series  
8" Dial

### FEATURES:

- All stainless steel construction for use with LPG & NH3 applications
- Welded tube to coupling design for maximum strength and durability
- Integral spring loaded shock absorber
- Exclusive easy to read "glow in the dark" dial face perfect for low light situations
- Dial face 100% sealed and argon filled to prevent moisture build-up & fogging
- factory set and precision tuned for superb accuracy
- Dial face and mounting hardware universal with other industry standard gauges
- Mounts to all standard 8 bolt tank flange adapters
- **Custom configurations available upon request**
- Available with classic style dial face



| Part No.          | Description                              | Dial Face    | Dial Size | Riser | Tank Diameter | Accessories                         |
|-------------------|--|--------------|-----------|-------|---------------|-------------------------------------|
| ME930TM4-108-5946 | Accu-Max Stationary ASME Top Mount Gauge | Glow/Black * | 4"        | 4"    | 108"          | ME931<br>2-1/2" MNPT Flange Adapter |
| ME930TM8-108-6346 |  |              | 4"        | 8"    | 108"          |                                     |
| ME930TM4-130-7056 |  |              | 4"        | 4"    | 130"          |                                     |
| ME930TM8-130-7456 |  |              | 4"        | 8"    | 130"          |                                     |
| ME940TM4-108-5948 |  |              | 8"        | 4"    | 108"          | ME932<br>Weld Type Flange Adapter   |
| ME940TM8-108-6348 |  |              | 8"        | 8"    | 108"          |                                     |
| ME940TM4-130-7060 |  |              | 8"        | 4"    | 130"          |                                     |
| ME940TM8-130-7460 |  |              | 8"        | 8"    | 130"          |                                     |

\* To order with classic (silver/black) dial face add "C" for Classic after the prefix part number, i.e. ME930TMC-108-6346  
NOTE: Custom configurations available upon request



# 30 DEGREE ANGLE MOUNT SERIES

Designed to measure liquid levels within horizontal DOT and Stationary ASME tanks with fluid capacities above 2,300 gallons. For maximum gauge life, the float arm features an integral spring loaded shock absorber for harsh over-the-road applications. The standard dial face features a black background for reduced glare with glow technology providing an easy to read "glow in the dark" dial face, perfect for low light situations. An optional classical style dial face is available. These gauges are suitable for use in bobtail, transport and bulk storage applications.

**NOTE:** These gauges are for 30 degree installation in regard to the centerline of the tank's side or end for accurate readings

| Part No.     | Type | Style    | Dial Face    | Dial Size | Tank Diameter |
|--------------|------|----------|--------------|-----------|---------------|
| ME930AM-72   | DOT  | Standard | Glow/Black   | 4"        | 72"           |
| ME930AM-79   | DOT  | Standard | Glow/Black   | 4"        | 79"           |
| ME930AM-84   | DOT  | Standard | Glow/Black   | 4"        | 84"           |
| ME930AMC-72  | DOT  | Classic  | Silver/Black | 4"        | 72"           |
| ME930AMC-79  | DOT  | Classic  | Silver/Black | 4"        | 79"           |
| ME930AMC-84  | DOT  | Classic  | Silver/Black | 4"        | 84"           |
| ME940AM-108  | ASME | Standard | Glow/Black   | 8"        | 108"          |
| ME940AM-130  | ASME | Standard | Glow/Black   | 8"        | 130"          |
| ME940AMC-108 | ASME | Classic  | Silver/Black | 8"        | 108"          |
| ME940AMC-130 | ASME | Classic  | Silver/Black | 8"        | 130"          |

## FEATURES

- All stainless steel construction
- Welded tube to coupling design for maximum strength and durability
- Dial face 100% sealed and argon filled to prevent moisture build-up & fogging
- Factory set and precision tuned for superb accuracy
- Dial face and mounting hardware universal with other industry standard gauges
- Mounts to all standard 8 bolt tank flange adapters
- **Custom length tank configurations available upon request for 30" to 300" I.D. tank**

Accu-Max™ Limited Warranty: Marshall Excelsior warrants Accu-Max™ float gauges and repair kits to the original buyer to be free of defects in material and workmanship under normal service and use for two years from manufactured date.



"Glow" Technology Standard Dial



ME940 ASME Series / 8" Dial Shown as Standard "Glow" Dial



ME930C DOT Series / 4" Dial Shown as Classic Dial

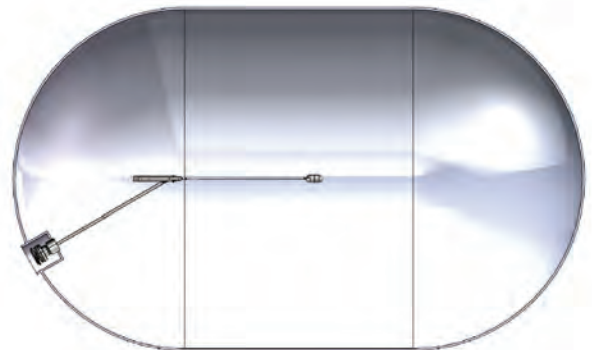
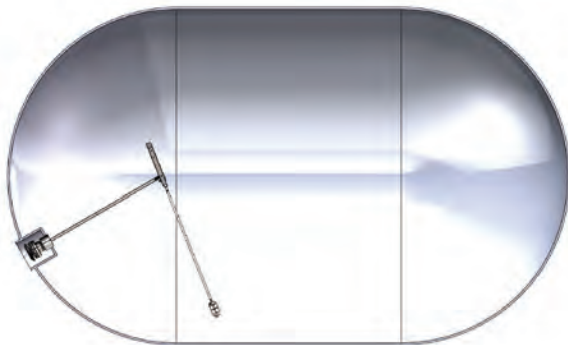

# ACCU-MAX™ FLOAT GAUGES

## TRANS-MAX SERIES

Measure liquid levels within horizontal DOT and Stationary ASME Tanks with 1" FNPT tank gauge port openings. Designed to replace rotary style gauges in tanks with fluid capacities greater than 2,300 gallons. Suitable for use in bobtail, transport, and bulk storage applications. MEC exclusive "wedge" design allows for easy installation while greatly reducing time spent inside the vessel.

NOTE: The heavy duty design of this gauge requires entering vessel through man-way during installation.



**ME930WG DOT Series**  
**ME940WG ASME Series**



U.S. PATENT  
#9,562,800



**MEP930WG**

\*Sold separately but highly recommended

### FEATURES

- All stainless steel construction for use with LPG & NH<sub>3</sub> applications
- Welded tube to coupling design for maximum strength and durability
- Installation requires man-way
- Converts rotary style gauge to heavy duty Accu-Max style for both mobile & stationary applications
- Integral spring loaded shock absorber for arduous over-the-road application
- Easy to assemble
- Exclusive easy to read "glow in the dark" dial face perfect for low light situations
- Dial face 100% sealed and argon filled to prevent moisture build-up & fogging
- Factory set and precision tuned for superb accuracy
- Dial face and mounting hardware universal with other industry standard gauges
- Mounts to all standard 1" NPT tank coupling adapters
- **Custom lengths available upon request**
- Available with classic style dial face

ACCU-MAX FLOAT GAUGES

| Trans-Max Accu-Max DOT Float Gauges |   |              |           |               |   |
|-------------------------------------|---|--------------|-----------|---------------|---|
| Part No.                            | Description   | Dial Face    | Dial Size | Tank Diameter | Accessories                                     |
| ME930WG-72                          | Trans-Max Accu-Max DOT Float Gauge Assembly           | Glow/Black   | 4"        | 72"           | MEP930WG<br>Zinc Plated<br>Installation<br>Tool |
| ME930WG-79                          | Trans-Max Accu-Max DOT Float Gauge Assembly           |              | 4"        | 79"           |   |
| ME930WG-84                          | Trans-Max Accu-Max DOT Float Gauge Assembly           |              | 4"        | 84"           |   |
| ME930CWG-72                         | Trans-Max Accu-Max DOT Float Gauge Assembly (Classic) | Silver/Black | 4"        | 72"           |   |
| ME930CWG-79                         | Trans-Max Accu-Max DOT Float Gauge Assembly (Classic) |              | 4"        | 79"           |   |
| ME930CWG-84                         | Trans-Max Accu-Max DOT Float Gauge Assembly (Classic) |              | 4"        | 84"           |   |

| Trans-Max Accu-Max ASME Stationary Float Gauges |  |              |           |               |   |
|---|--|--------------|-----------|---------------|---|
| Part No.  | Description  | Dial Face    | Dial Size | Tank Diameter | Accessories                                     |
| ME940WG-108                                     | Trans-Max Accu-Max Stationary Float Gauge Assembly           | Glow/Black   | 8"        | 108"          | MEP930WG<br>Zinc Plated<br>Installation<br>Tool |
| ME940WG-130                                     | Trans-Max Accu-Max Stationary Float Gauge Assembly           |              | 8"        | 130"          |   |
| ME940CWG-108                                    | Trans-Max Accu-Max Stationary Float Gauge Assembly (Classic) | Silver/Black | 8"        | 108"          |   |
| ME940CWG-130                                    | Trans-Max Accu-Max Stationary Float Gauge Assembly (Classic) |              | 8"        | 130"          |   |



# PRESSURE RELIEF VALVE WARNING

## INSPECTION

A pressure relief valve discharges when some extraordinary circumstance causes an over pressure condition in the container. If a pressure relief valve is known to have discharged, the relief valve, as well as the entire system, should be immediately and thoroughly inspected to determine the reason for the discharge. In the case of discharge due to fire, the valve should be removed from service and replaced.

Relief valves should be inspected each time the container is filled but no less than once a year. If there is any doubt about the condition of the valve, it must be replaced.

**WARNING:** Eye protection must be worn when performing inspection on relief valves under pressure. Never look directly into a relief valve under pressure or place any part of your body where the relief valve discharge could impact it. In some cases a flashlight and small mirror are suggested to assist when making visual inspections.

In the case of a pressure relief valve that has opened due to a pressure beyond its start-to-discharge setting, the chances of foreign material lodging between the seat and the disc is low, however the possibility is always present. If the relief valve continues to leak at pressure below its start-to-discharge setting it must be replaced.

If there is any doubt about the condition of the relief valve, or if the relief valve has not been protected by a cap for some time, it should be replaced before refilling the container.

### Inspection Checklist:

1. Cap: Check that the protective cap is in place over the valve or pipeaway stack outlet and has a snug fit. The protective cap helps protect the relief valve against possible malfunction caused by rain, sleet, snow, ice, sand, dirt, pebbles, insects, other debris and contamination. Replace damaged or missing caps at once and keep a cap in place at all times.
2. Weep Holes: Inspect and clear debris from the relief valve weep holes. Dirt, ice, paint, and other foreign particles can prevent proper drainage from the valve body. If the weep holes cannot be cleared, replace the valve.
3. Relief Valve Spring: Exposure to high concentrations of water, salt, industrial pollutants and contaminants could cause metal parts to fail including the relief valve spring. If the coating on the relief valve spring is cracked or chipped, replace the valve.
4. Physical Damage: Ice accumulations and improper installation could cause mechanical damage. If there are any indications of damage, replace the valve.

5. Tampering or Readjustment: Pressure relief valves are factory set to discharge at specified pressures. If there are any indications of tampering or readjusting, replace the valve.
6. Seat Leakage: Check for leaks in the seating area using Marshall Excelsior leak detector solution. If there is any indication of leakage, replace the valve. Never force a relief valve closed and continue to leave it in service. This could result in damage to the valve and possible rupture of the container or piping on which the valve is installed.
7. Corrosion: Replace the valve if there are any signs of corrosion or contamination.
8. Moisture, Foreign Particles or Contaminants in the Valve: Foreign material such as paint, tar or ice in relief valve parts can impair the proper functioning of the valves. Grease placed in the valve body may harden over time or collect contaminants, thereby impairing the proper operation of the relief valve. Do not place grease in the valve body; replace the valve if there are any indications of moisture or foreign matter in the valve.
9. Corrosion or Leakage at Container Connection: Check container to valve connection using Marshall Excelsior leak detector solution. Replace the valve if there is any indication of corrosion or leakage at the connection between the valve and container.

**CAUTION:** Never plug the outlet of a pressure relief valve. Any device used to stop the flow of a properly operating pressure relief valve that is venting an over pressurized container can cause severe consequences.

### PRODUCT AGE

To determine the product's age, check the product for a date code consisting of a series of letters and numbers.

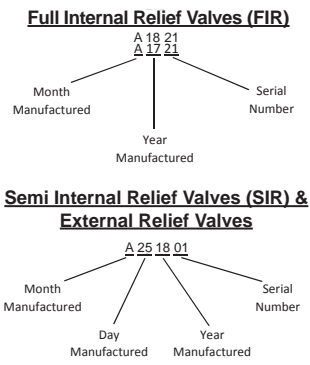

## OPERATION OF PRESSURE RELIEF VALVES

Pressure relief valves are set and sealed by the manufacturer to function at a specific "start-to-discharge" pressure in accordance with UL 132. This set pressure is marked on the relief valve and depends on the design requirement of the container to be protected by the relief valve. If the container pressure reaches the start-to-discharge pressure, the relief valve will open a slight amount as the seat disc begins to move slightly away from the seat. If the pressure continues to rise despite the initial discharge through the relief valve, the seat disc will move to a full open position with a sudden "pop". This popping sound is from which the term "pop-action" is derived.

Whether the relief valve opens a slight amount or pops wide open, it will start to close if the pressure in the container diminishes. After the pressure has decreased sufficiently, the relief valve spring will force the seat disc against the seat tightly enough to prevent any further escape of product. The pressure at which the valve closes tightly is referred to as the "re-seal" or "blow-down" pressure. Generally, the re-seal pressure will be lower than the start-to-discharge pressure.

### Requirements for Pressure Relief Valves

Every container used for storing or hauling LP-Gas and NH<sub>3</sub> must be protected by a pressure relief valve. These valves are designed to protect the container against the development of hazardous conditions which might be created by any of the following:

- High pressures resulting from exposure of the container to excessive external heat.
- High pressures due to the use of incorrect fuel.
- High pressures due to improper purging of the container.

Consult NFPA #58 for LP-Gas and ANSI #K61.1 for NH<sub>3</sub>, and/or any applicable local and state regulations governing the application and use of pressure relief valves.

### Selection of MEC Pressure Relief Valves for ASME Containers

The rate of discharge required for a given container is determined by the calculation of the surface area of the container as shown in "Chart A" for LP-Gas and "Chart B" for NH<sub>3</sub>.

The set pressure of a pressure relief valve depends upon the design pressure of the container. Refer to NFPA #58 "Liquefied Petroleum Gas Code" for more information.





# PRESSURE RELIEF VALVE WARNING

## Chart A - Minimum Required Rate of Discharge for LP-Gas Pressure Relief Valves Used on

### ASME Containers

From NFPA Code #58, Table 5.9.2.6 (2020 Edition)

Minimum required rate of discharge in cubic feet per minute of air at 120% of the maximum permitted start-to-discharge pressure relief valves to be used on containers other than those constructed in accordance with Interstate Commerce specification.

| Surface Area Sq. Ft. | Flow Rate CFM Air | Surface Area Sq. Ft. | Flow Rate CFM Air | Surface Area Sq. Ft. | Flow Rate CFM Air | Surface Area Sq. Ft. | Flow Rate CFM Air | Surface Area Sq. Ft. | Flow Rate CFM Air | Surface Area Sq. Ft. | Flow Rate CFM Air | Surface Area Sq. Ft. | Flow Rate CFM Air |
|----------------------|-------------------|----------------------|-------------------|----------------------|-------------------|----------------------|-------------------|----------------------|-------------------|----------------------|-------------------|----------------------|-------------------|
| 20 or less           | 626               | 85                   | 2050              | 150                  | 3260              | 230                  | 4630              | 360                  | 6690              | 850                  | 13540             | 1500                 | 21570             |
| 25                   | 751               | 90                   | 2150              | 155                  | 3350              | 240                  | 4800              | 370                  | 6840              | 900                  | 14190             | 1550                 | 22160             |
| 30                   | 872               | 95                   | 2240              | 160                  | 3440              | 250                  | 4960              | 380                  | 7000              | 950                  | 14830             | 1600                 | 22740             |
| 35                   | 990               | 100                  | 2340              | 165                  | 3530              | 260                  | 5130              | 390                  | 7150              | 1000                 | 15470             | 1650                 | 23320             |
| 40                   | 1100              | 105                  | 2440              | 170                  | 3620              | 270                  | 5290              | 400                  | 7300              | 1050                 | 16100             | 1700                 | 23900             |
| 45                   | 1220              | 110                  | 2530              | 175                  | 3700              | 280                  | 5450              | 450                  | 8040              | 1100                 | 16720             | 1750                 | 24470             |
| 50                   | 1330              | 115                  | 2630              | 180                  | 3790              | 290                  | 5610              | 500                  | 8760              | 1150                 | 17350             | 1800                 | 25050             |
| 55                   | 1430              | 120                  | 2720              | 185                  | 3880              | 300                  | 5760              | 550                  | 9470              | 1200                 | 17960             | 1850                 | 25620             |
| 60                   | 1540              | 125                  | 2810              | 190                  | 3960              | 310                  | 5920              | 600                  | 10170             | 1250                 | 18570             | 1900                 | 26180             |
| 65                   | 1640              | 130                  | 2900              | 195                  | 4050              | 320                  | 6080              | 650                  | 10860             | 1300                 | 19180             | 1950                 | 26750             |
| 70                   | 1750              | 135                  | 2990              | 200                  | 4130              | 330                  | 6230              | 700                  | 11550             | 1350                 | 19780             | 2000                 | 27310             |
| 75                   | 1850              | 140                  | 3080              | 210                  | 4300              | 340                  | 6390              | 750                  | 12220             | 1400                 | 20380             |                      |                   |
| 80                   | 1950              | 145                  | 3170              | 220                  | 4470              | 350                  | 6540              | 800                  | 12880             | 1450                 | 20980             |                      |                   |

**Surface area** = Total outside surface area of container in square feet.

When the surface area is not stamped on the name plate or when the marking is not legible, the area can be calculated by using one of the following formulas:

- Cylindrical container with hemispherical heads. Area (in sq. ft.) = overall length (ft.) x outside diameter (ft.) x 3.1416
- Cylindrical container with other than hemispherical heads. Area (in sq. ft.) = [overall length (ft.) + .3 outside diameter (ft.)] x outside diameter (ft.) x 3.1416.
- Spherical container. Area (in sq. ft.) = outside diameter (ft.) squared x 3.1416.

**Flow Rate CFM Air** = Required flow capacity in cubic feet per minute of air at standard conditions, 60°F. and atmospheric pressure (14.7 psia).

The flow rate discharge may be interpolated for intermediate values of surface

area. For containers with total outside surface area greater than 2000 square feet, the required flow rate can be calculated using the formula. Flow Rate in CFM Air = 53.632 A<sup>0.82</sup>. Where A = total outside surface area of the container in square feet.

Valves not marked "Air" have rate marking in cubic feet per minute of liquefied petroleum gas. These can be converted to ratings in cubic feet per minute of air by multiplying the liquefied petroleum gas ratings by the factors listed below. Air flow ratings can be converted to ratings in cubic feet per minute of liquefied petroleum gas by dividing the air ratings by the factors listed below.

#### Air Conversion Factors

|                       |     |       |       |       |       |       |
|-----------------------|-----|-------|-------|-------|-------|-------|
| Container Type        | 100 | 125   | 150   | 175   | 200   |       |
| Air Conversion Factor |     | 1.162 | 1.142 | 1.113 | 1.078 | 1.010 |

## Chart B - Minimum Required Rate of Discharge for Anhydrous Ammonia Pressure Relief Valves Used on ASME Containers

From ANSI/CGA G-2.1-2014, Appendix A

Minimum required rate of discharge in cubic feet per minute of air at 120% of the maximum permitted start-to-discharge pressure for pressure relief valves to be used on containers other than those constructed in accordance with United States Department of Transportation cylinder specifications.

| Surface Area Sq. Ft. | Flow Rate CFM Air | Surface Area Sq. Ft. | Flow Rate CFM Air | Surface Area Sq. Ft. | Flow Rate CFM Air | Surface Area Sq. Ft. | Flow Rate CFM Air | Surface Area Sq. Ft. | Flow Rate CFM Air | Surface Area Sq. Ft. | Flow Rate CFM Air | Surface Area Sq. Ft. | Flow Rate CFM Air |
|----------------------|-------------------|----------------------|-------------------|----------------------|-------------------|----------------------|-------------------|----------------------|-------------------|----------------------|-------------------|----------------------|-------------------|
| 20                   | 258               | 85                   | 845               | 150                  | 1350              | 230                  | 1920              | 360                  | 2760              | 850                  | 5590              | 1500                 | 8900              |
| 25                   | 310               | 90                   | 885               | 155                  | 1390              | 240                  | 1980              | 370                  | 2830              | 900                  | 5850              | 1550                 | 9140              |
| 30                   | 360               | 95                   | 925               | 160                  | 1420              | 250                  | 2050              | 380                  | 2890              | 950                  | 6120              | 1600                 | 9380              |
| 35                   | 408               | 100                  | 965               | 165                  | 1460              | 260                  | 2120              | 390                  | 2950              | 1000                 | 6380              | 1650                 | 9620              |
| 40                   | 455               | 105                  | 1010              | 170                  | 1500              | 270                  | 2180              | 400                  | 3010              | 1050                 | 6640              | 1700                 | 9860              |
| 45                   | 501               | 110                  | 1050              | 175                  | 1530              | 280                  | 2250              | 450                  | 3320              | 1100                 | 6900              | 1750                 | 10090             |
| 50                   | 547               | 115                  | 1090              | 180                  | 1570              | 290                  | 2320              | 500                  | 3620              | 1150                 | 7160              | 1800                 | 10330             |
| 55                   | 591               | 120                  | 1120              | 185                  | 1600              | 300                  | 2380              | 550                  | 3910              | 1200                 | 7410              | 1850                 | 10560             |
| 60                   | 635               | 125                  | 1160              | 190                  | 1640              | 310                  | 2450              | 600                  | 4200              | 1250                 | 7660              | 1900                 | 10800             |
| 65                   | 678               | 130                  | 1200              | 195                  | 1670              | 320                  | 2510              | 650                  | 4480              | 1300                 | 7910              | 1950                 | 11030             |
| 70                   | 720               | 135                  | 1240              | 200                  | 1710              | 330                  | 2570              | 700                  | 4760              | 1350                 | 8160              | 2000                 | 11260             |
| 75                   | 762               | 140                  | 1280              | 210                  | 1780              | 340                  | 2640              | 750                  | 5040              | 1400                 | 8410              |                      |                   |
| 80                   | 804               | 145                  | 1310              | 220                  | 1850              | 350                  | 2700              | 800                  | 5300              | 1450                 | 8650              |                      |                   |

**Surface area** = Total outside surface area of container in square feet.

When the surface area is not stamped on the name plate or when the marking is not legible, the area can be calculated by using one of the following formulas:

- Cylindrical container with hemispherical heads. Area (in sq. ft.) = overall length (ft.) x outside diameter (ft.) x 3.1416
- Cylindrical container with other than hemispherical heads. Area (in sq. ft.) = [overall length (ft.) + .3 outside diameter (ft.)] x outside diameter (ft.) x 3.1416.
- Spherical container. Area (in sq. ft.) = outside diameter (ft.) squared x 3.1416.

**Flow Rate CFM Air** = Required flow capacity in cubic feet per minute of air at standard conditions, 60°F. and atmospheric pressure (14.7 psia).

The rate of discharge may be interpolated for intermediate values of surface area. For containers with total outside surface area greater than 2,500 square feet, the required flow rate can be calculated using the formula, Flow Rate in CFM Air = 22.11 A<sup>0.82</sup> where A = outside surface area of the container in square feet.

#### Conversion Factor

$$\begin{aligned} \text{ft}^2 \times 0.092903 &= \text{m}^2 \\ \text{CFM} \times 0.028317 &= \text{m}^3/\text{min} \\ \text{ft} \times 0.3048 &= \text{m} \end{aligned}$$

PRESSURE RELIEF VALVES & MANIFOLDS



## INSTALLATION

**WARNING:** Failure to follow these instructions or to properly install and maintain this equipment could result in an explosion and/or fire causing property damage and personal injury or death. Marshall Excelsior Company equipment must be installed, operated and maintained in accordance with all federal, state and local codes and Marshall Excelsior Company instructions. The installation in most states must also comply with NFPA standards 58 and 59, and ANSI K61.1. Only personnel trained in the proper procedures, codes, standards and regulations of the LP-Gas and NH<sub>3</sub> industries should install, maintain and service this equipment.

Be sure all instructions are read and understood before installation, operation and maintenance. These instructions must be passed along to the end user of the product.

**CAUTION:** Contact or inhalation of liquid propane, ammonia and their vapors can cause serious injury or death! NH<sub>3</sub> and LP-Gas must be released outdoors in air currents that will insure dispersion to prevent exposure to people and livestock. LP-Gas must be kept far enough from any open flame or other source of ignition to prevent fire or explosion! LP-Gas is heavier than air and will not disperse or evaporate rapidly if released in still air.

Consult NFPA Codes 58 and 59 / ANSI K61.1 and/or any applicable regulations governing the application and use of pressure relief valves. Make sure you are thoroughly trained before you attempt any valve installation, inspection or maintenance.

Proper installation is essential to the safe operation of pressure relief valves. Install MEC pressure relief valves using the following steps:

1. Check that the valve is clean and free of foreign material in the valve inlet and outlet.
2. Verify that the relief valve start-to-discharge setting and flow rate is correct for the application.
3. Apply a suitable PTFE thread sealant compound to the external NPT threads.
4. Inspect the relief valve inlet and valve seat to ensure no thread sealant or foreign material is present.
5. Install relief valve into container port or manifold using appropriate wrench until leak tight joint is achieved.
6. Check for damage and proper operation after valve installation.
7. After the container is charged with product, check joints for leakage using Marshall Excelsior leak detector.
8. After installation is complete, replace protective cap onto relief valve.

Pipeaways and deflectors may be required by local codes, laws and regulations depending on the installation. Use only MEC adapters on MEC relief valves. Adapters not designed specifically for piping away MEC relief valves, such as those with 90° turns will reduce internal diameters, and decrease flow dramatically. These should never be used as they can cause the relief valve to chatter and eventually destroy itself.

The addition of deflectors, pipeaway adapters and piping will restrict the flow. To properly protect any container, the total system flow must be sufficient to relieve pressure at the pressure setting of the relief valve in accordance with all applicable codes.

## RELIEF VALVE SAFETY INFORMATION

**Repair and Testing:** MEC Pressure Relief Valves are tested and listed by Underwriters Laboratories, Inc., in accordance with UL 132 and NFPA Code #58. Construction and performance of MEC Pressure Relief Valves are consistently checked at the factory by UL and ASME audits. Therefore, testing of MEC Pressure Relief Valves in the field is not necessary.

Any pressure relief valves which shows evidence of leakage, other improper operation or is suspect as to its performance must be replaced immediately using approved procedures.

**PIPEAWAY ADAPTERS:** Pipeaway adapters are available for most MEC Pressure Relief Valves, where it is required or desirable to pipe the discharge above or away from the container. Each adapter is designed to sever if excessive stress is applied to the vent piping—thus leaving the relief valve intact and fully operative.

## REPLACEMENT OF PRESSURE RELIEF VALVES

**WARNING:** Under normal conditions, the useful safe service life of a pressure relief valve is 10 years from the original date of manufacture. However, the safe useful life of the valve may be shortened and replacement required in less than 10 years depending on the environment in which the valve lives. Inspection and maintenance of pressure relief valves is very important. Failure to properly inspect and maintain pressure relief valves could result in personal injuries or property damage.

The safe useful life of pressure relief valves can vary greatly depending on the environment in which they live.

Relief valves are required to function under widely varying conditions. Corrosion, aging of the resilient seat disc and friction all proceed at different rates depending upon the nature of the specific environment and application. Gas impurities, product misuse and improper installations can shorten the safe life of a relief valve. The LP-Gas dealer must observe and determine the safe useful life of relief valves in his systems.

For Additional Information Read:

1. NFPA # 58, "Storage and Handling of Liquefied Petroleum Gases".
2. NFPA # 59, "LP-Gases and Utility Gas Plants"

Relief valves in service beyond their service life can exhibit the following degradation in function:

- They may leak at pressures below the set pressure.
- They may open and fail to properly reset.
- They may open at higher than set pressure.

These failures to function properly are due primarily to four "environmental" conditions:

1. Corrosion of metal parts (particularly springs) which result in the component parts failing to perform.
2. Deterioration of synthetic rubber seat disc material.
3. Clogging or "cementing" of the movable relief valve components so that their movement is restricted.
4. Debris on the valve seat after the relief valve opens, effectively preventing the valve from resealing.

Corrosion is caused by water, corrosive atmospheres of salt and high industrial pollutants, chemicals, and contaminants. High concentrations can attack the metal parts vigorously. No suitable metals are totally resistant to such corrosion.

Synthetic rubber and seat disc materials can also be attacked by impurities in the gas and corrosive atmospheres, particularly those with sulphur dioxide. There are no suitable rubber materials which resist all contaminants.

"Cementing" of relief valve parts can be caused by normal industrial atmospheres containing particles of dirt, iron oxide, metal chips, etc. combined with water, oil, or grease. Ice collecting in recessed valves could cause failure to open. Paint and tar in relief valves also cause failure to function properly.

While the functioning of a pressure relief valve appears to be relatively simple, the assembly and test procedure used to manufacture these MEC products is rather complex. Highly specialized test fixtures and specially trained personnel are necessary to attain proper relief valve settings. These fixtures and personnel are available only at the factory.

**WARNING:** Never attempt to repair or change the setting of MEC Pressure Relief Valves. Any changes in settings or repairs in the field will void the MEC warranty and product listings, and may create a serious hazard.

# QUAD-PORT RELIEF VALVE MANIFOLD

Designed for use with large LP-Gas and NH<sub>3</sub> stationary storage containers with flanged openings. These relief manifolds have an additional relief valve excluded from the flow rating, which allows for service and/or exchange of any one relief valve without evacuating the tank. Our large port selection handle allows for each specific valve port to be closed off so that the relief valve may be removed while the remaining valves remain under pressure protecting the tank and contents. Each manifold model is rated based on the flow through the relief valves with one valve removed from service.

## FEATURES

- Heavy duty ductile iron body
- Durable V-cup PTFE packing stem seals
- Molded rubber weather guard for manifold rotary gear with port plug
- Integral breakaway feature leaves seat and seal intact
- Weep hole deflector and hex socket plugs supplied
- Integrated pilot equalizing feature
- Corrosion resistant finish
- Convenient lifting chain included
- 3-1/2"-8 outlet thread accepts 3" MNPT pipeaway

## MEP990-4DFM/3DFM

Flange Reducing Spool Adapter



| Part No.        | Flange Size              | No. of Relief Valves | Application           | Flow Capacity SCFM/Air <sup>(2)</sup> UL @ 120% Set Pressure | Factory Installed Relief Valve |                                 |              | Accessory                           |
|-----------------|--------------------------|----------------------|-----------------------|--|--------------------------------|---------------------------------|--------------|-------------------------------------|
|                 |                          |                      |                       |  | Seal Material <sup>(2)</sup>   | Start-to-Discharge Setting PSIG | Part No.     | 8 Stud / Nut Universal Mounting Kit |
| ME903S-3F/250VM | 3" - 300# <sup>(1)</sup> | 3                    | LPG                   | 20,400 (2)   | FKM                            | 250                             | MEV250VM/250 | ME904SK                             |
| ME903S-3F/250CN | 3" - 300# <sup>(1)</sup> | 3                    | LPG & NH <sub>3</sub> | 20,400 (2)   | Nitrile                        | 250                             | MEV250CN/250 |                                     |
| ME903S-4F/250VM | 4" - 300#                | 3                    | LPG                   | 20,400 (2)   | FKM                            | 250                             | MEV250VM/250 |                                     |
| ME903S-4F/250CN | 4" - 300#                | 3                    | LPG & NH <sub>3</sub> | 20,400 (2)   | Nitrile                        | 250                             | MEV250CN/250 |                                     |
| ME904S-3F       | 3" - 300# <sup>(1)</sup> | 0                    | -                     | -  | -                              | -                               | -            |                                     |
| ME904S-3F/250VM | 3" - 300# <sup>(1)</sup> | 4                    | LPG                   | 27,740 (3)   | FKM                            | 250                             | MEV250VM/250 |                                     |
| ME904S-3F/250CN | 3" - 300# <sup>(1)</sup> | 4                    | LPG & NH <sub>3</sub> | 27,740 (3)   | Nitrile                        | 250                             | MEV250CN/250 |                                     |
| ME904S-4F       | 4" - 300#                | -                    | -                     | -  | -                              | -                               | -            |                                     |
| ME904S-4F/250VM | 4" - 300#                | 4                    | LPG                   | 27,740 (3)   | FKM                            | 250                             | MEV250VM/250 |                                     |
| ME904S-4F/250CN | 4" - 300#                | 4                    | LPG & NH <sub>3</sub> | 27,740 (3)   | Nitrile                        | 250                             | MEV250CN/250 |                                     |
| ME903S-3F/265VM | 3" - 300# <sup>(1)</sup> | 3                    | LPG                   | 20,555 (2)   | FKM                            | 265                             | MEV250VM/265 |                                     |
| ME903S-3F/265CN | 3" - 300# <sup>(1)</sup> | 3                    | LPG & NH <sub>3</sub> | 20,555 (2)   | Nitrile                        | 265                             | MEV250CN/265 |                                     |
| ME903S-4F/265VM | 4" - 300#                | 3                    | LPG                   | 20,555 (2)   | FKM                            | 265                             | MEV250VM/265 |                                     |
| ME903S-4F/265CN | 4" - 300#                | 3                    | LPG & NH <sub>3</sub> | 20,555 (2)   | Nitrile                        | 265                             | MEV250CN/265 |                                     |
| ME904S-3F/265VM | 3" - 300# <sup>(1)</sup> | 4                    | LPG                   | 28,550 (3)   | FKM                            | 265                             | MEV250VM/265 |                                     |
| ME904S-3F/265CN | 3" - 300# <sup>(1)</sup> | 4                    | LPG & NH <sub>3</sub> | 28,550 (3)   | Nitrile                        | 265                             | MEV250CN/265 |                                     |
| ME904S-4F/265VM | 4" - 300#                | 4                    | LPG                   | 28,550 (3)   | FKM                            | 265                             | MEV250VM/265 |                                     |
| ME904S-4F/265CN | 4" - 300#                | 4                    | LPG & NH <sub>3</sub> | 28,550 (3)   | Nitrile                        | 265                             | MEV250CN/265 |                                     |

(1) For use with modified 300 # ANSI Flange with 4" port  
 (3) Nitrile not UL Listed

(2) Flow rating based on number of valves indicated in parenthesis ( )  
 Flow rates are shown as bare relief valves, pipeaways will reduce flow

| Accessories      |  |
|------------------|--|
| Part No.         | Description  |
| MEP990-4DFM/3DFM | 4"-300 LB X 3"-300 LB Flanged ACF/ESV/ISC Adapting Spool Kit |



# MINI QUAD-PORT MANIFOLD WITH FACTORY INSTALLED RELIEF VALVES

For use with large LPG & NH<sub>3</sub> stationary storage containers with 2" FNPT openings. These Relief Manifolds have an additional relief valve excluded from the flow rating, which allows for service and/or exchange of any one relief valve without evacuating the tank. Our large port selection handle allows for each specific valve port to be closed off so that the relief valve may be removed while the remaining valves stay under pressure protecting the tank and contents. Each manifold model is rated based on the flow through the relief valves with one valve removed from service.



## FEATURES

- Heavy Duty Ductile Iron Body
- All Stainless Steel Internal Components
- Durable PTFE V-Pack Stem Seals
- Large Diameter Port Selection Handle and Port Indicator
- Molded Rubber Weather Guard for Manifold Rotary Gear with Port Plug
- Available with 250 PSIG and 265 PSIG Relief Valve Set Pressures
- Vapor Equalizing Feature for Easy Port to Port Rotation
- Includes Tank Stabilizer Nut for Maximum Strength at Container Connection
- **COVERS MOST 30,000 GALLON TANKS WITH TWO OR THREE MANIFOLDS DEPENDING IN THE TANK DIAMETER**



**MEP178K**  
(Pipeaway Adapter & Stabilizer Kit)

| Part No. <sup>(2)</sup> | Relief Valve STD | Application |                 | Tank Connection Size | Relief Valve |             | * Flow Rating SCFM/AIR @ 120% of set pressure<br>UL Rating |
|-------------------------|------------------|-------------|-----------------|----------------------|--------------|-------------|--|
|                         |                  | LPG         | NH <sub>3</sub> |                      | # of Valves  | Part No.    |  |
| ME902S-16B/250          | 250 PSIG         | YES         | NO              | 2" MNPT              | 2            | MEV125B/250 | 5,115 (1)  |
| ME902S-16/250           | 250 PSIG         | NO          | YES             | 2" MNPT              | 2            | MEV125/250  | 5,115 (1)  |
| ME902S-16/265           | 265 PSIG         | NO          | YES             | 2" MNPT              | 2            | MEV125/265  | 5,855 (1)  |
| ME903S-16B/250          | 250 PSIG         | YES         | NO              | 2" MNPT              | 3            | MEV125B/250 | 9,320 (2)  |
| ME903S-16/250           | 250 PSIG         | NO          | YES             | 2" MNPT              | 3            | MEV125/250  | 9,320 (2)  |
| ME903S-16/265           | 265 PSIG         | NO          | YES             | 2" MNPT              | 3            | MEV125/265  | 10,795 (2)   |
| ME904S-16B/250          | 250 PSIG         | YES         | NO              | 2" MNPT              | 4            | MEV125B/250 | 12,481 (3)   |
| ME904S-16/250           | 250 PSIG         | NO          | YES             | 2" MNPT              | 4            | MEV125/250  | 12,481 (3)   |
| ME904S-16/265           | 265 PSIG         | NO          | YES             | 2" MNPT              | 4            | MEV125/265  | 13,630 (3)   |

(1) Flow rating based on number of valves indicated in parenthesis ( ).

Flow rates shown are for bare relief valves, pipeways will reduce flow rates.

(2) To order FKM seal materials add "VM" after the prefix part number - i.e. ME904S-16B/250VM

| Accessories |   |
|-------------|---|
| Part No.    | Description   |
| MEP178      | Pipeaway Adapter for MEV125 Series w/ 2" FNPT Outlet - Aluminum |
| MEP178K     | Pipeaway Adapter Kit w Stabilizer Bracket for ME904S-16         |
| MEP123      | Installation / Removal Tool for MEV125 Series Relief Valves     |

# MINI QUAD-PORT TANK SIZING CHART

| TANK SIZING REFERENCE CHART |                  |                         |                           |                           |                           |                           |                           |
|-----------------------------|------------------|-------------------------|---------------------------|---------------------------|---------------------------|---------------------------|---------------------------|
| Part No.                    | Relief Valve STD | LPG                     |                           |                           | NH <sub>3</sub>           |                           |                           |
|                             |                  | 30,000 Gallon 109" O.D. | 30,000 Gal- lon 131" O.D. | 18,000 Gal- lon 109" O.D. | 30,000 Gal- lon 109" O.D. | 30,000 Gal- lon 131" O.D. | 18,000 Gal- lon 109" O.D. |
| ME902 Series                | 250 PSIG         | N/A                     | 5                         | 3                         | 2                         | 2                         | 2                         |
| ME902 Series                | 265 PSIG         | N/A                     | N/A                       | 3                         | 2                         | 2                         | 2                         |
| ME903 Series                | 250 PSIG         | 3                       | 3                         | 2                         | 2                         | 1                         | 1                         |
| ME903 Series                | 265 PSIG         | 3                       | 3                         | 2                         | 2                         | 1                         | 1                         |
| ME904 Series                | 250 PSIG         | 3                       | 2                         | 2                         | 1                         | 1                         | 1                         |
| ME904 Series                | 265 PSIG         | 3                       | 2                         | 2                         | 1                         | 1                         | 1                         |

\* Number indicates quantity of relief manifolds to adequately relief vapor overpressure conditions for listed tank surface areas

## MINI QUAD-PORT RELIEF VALVE MANIFOLD WITHOUT RELIEF VALVES

For use with large LPG & NH<sub>3</sub> stationary storage containers with 2" FNPT openings. These Relief Manifolds have an additional relief valve excluded from the flow rating, which allows for service and/or exchange of any one relief valve without evacuating the tank. Our large port selection handle allows for each specific valve port to be closed off so that the relief valve may be removed while the remaining valves stay under pressure protecting the tank and contents. Each manifold model is rated based on the flow through the relief valves with one valve removed from service.

PRESSURE RELIEF VALVES & MANIFOLDS



### FEATURES

- Heavy duty ductile iron body
- All stainless steel internal components
- Durable PTFE V-pack stem seals
- Large diameter port selection handle and port indicator
- Molded rubber weather guard for manifold rotary gear with port plug
- Vapor equalizing feature for easy port-to-port rotation
- Includes tank stabilizer nut for maximum strength at container connection



| Part No.    | Tank Connection Size   | Application |                 |
|-------------|--|-------------|-----------------|
|             |  | LPG         | NH <sub>3</sub> |
| ME904S-16   | 2" MNPT  | Yes         | Yes             |
| Accessories |  |             |                 |
| Part No.    | Description  | Application |                 |
|             |  | LPG         | NH <sub>3</sub> |
| MEV125/250  | 1-1/4"MNPT External Relief Valve-Nitrile 250PSI - 6,328 SCFM | No          | Yes             |
| MEV125/265  | 1-1/4"MNPT External Relief Valve-Nitrile 265PSI - 6,542 SCFM | No          | Yes             |
| MEV125B/250 | 1-1/4"MNPT External Relief Valve-Nitrile 250PSI - 6,328 SCFM | Yes         | No              |
| MEV125B/265 | 1-1/4"MNPT External Relief Valve-Nitrile 265PSI - 6,542 SCFM | Yes         | No              |



# EXTERNAL PRESSURE RELIEF VALVES

## 1/4" NPT ~ 1" NPT

Designed for installation in stationary ASME applications such as bulk plant, skid tanks, underground and above ground containers, as the primary pressure relief valve.

NOTE: This valve and all working parts are to be installed outside the container. Therefore, to ensure proper operation of the valve, the valve must be protected from damage and inspections performed as prescribed by Marshall Excelsior.

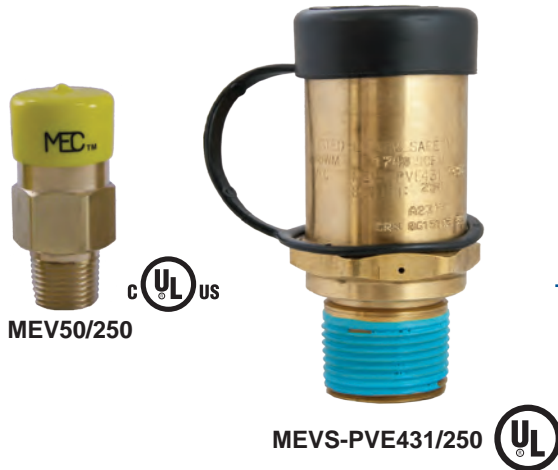

### FEATURES

- Brass construction for LP-Gas application
- Compact design to fit any application
- Stainless steel spring
- Specially designed internal components to increase flow at discharge
- Custom start-to-discharge settings available upon request
- Non-adjustable, tamper resistant design

| Part No.         | Container Connection | Seal Material * | Start-to-Discharge Setting PSIG | OAL      | Wrench Hex | Flow Capacity SCFM/Air **<br>UL @ 120% Set Pressure | Application | Accessories                     |
|------------------|----------------------|-----------------|---------------------------------|----------|------------|---|-------------|---------------------------------|
| MEV25/60         | 1/4" MNPT            | Nitrile         | 60 PSIG                         | 1-59/64" | 7/8"       | —   | LPG         | MEP173<br>Pipeaway<br>Adapter   |
| MEV25/250        | 1/4" MNPT            | Nitrile         | 250 PSIG                        | 1-59/64" | 7/8"       | —   | LPG         |                                 |
| MEV25/312        | 1/4" MNPT            | Nitrile         | 312 PSIG                        | 1-59/64" | 7/8"       | —   | LPG         |                                 |
| MEV25/375        | 1/4" MNPT            | Nitrile         | 375 PSIG                        | 1-59/64" | 7/8"       | —   | LPG         |                                 |
| MEV50/250        | 1/2" MNPT            | Nitrile         | 250 PSIG                        | 2-1/2"   | 1-1/8"     | 200   | LPG         | MEP174<br>Pipeaway<br>Adapter   |
| MEV50/375        | 1/2" MNPT            | Nitrile         | 375 PSIG                        | 2-1/2"   | 1-1/8"     | —   | LPG         |                                 |
| MEV75/250        | 3/4" MNPT            | Nitrile         | 250 PSIG                        | 2-21/32" | 1-1/8"     | —   | LPG         |                                 |
| MEV75/312        | 3/4" MNPT            | Nitrile         | 312 PSIG                        | 2-21/32" | 1-1/8"     | —   | LPG         |                                 |
| MEV75/375        | 3/4" MNPT            | Nitrile         | 375 PSIG                        | 2-21/32" | 1-1/8"     | —   | LPG         |                                 |
| MEVS-PVE431B/250 | 3/4" MNPT            | Nitrile         | 250 PSIG                        | 3-21/64" | 1-3/4"     | 1,740   | LPG         | MEPS-431<br>Pipeaway<br>Adapter |
| MEVS-PVE431/250  | 1" MNPT              | Nitrile         | 250 PSIG                        | 4"       | 1-3/4"     | 1,740   | LPG         |                                 |

Note: Per NFPA Code #58, Table 5.9.2.6 (2017 Edition) area shown is for UL or ASME flow rating, which ever is greater

\* FKM and FFKM options available. Not UL Listed

\*\* Flow rates are shown for bare relief valves, pipeaways will reduce flow

# EXTERNAL PRESSURE RELIEF VALVES

## 1-1/4" & 2-1/2" NPT

NH<sub>3</sub>



**MEV125/250**  
(Aluminum)

LPG



**MEV125B/250**  
(Brass)



**MEV250VM/250**



**MEV125 Series** - Designed for use with large LPG & NH<sub>3</sub> storage containers as a primary pressure relief valve on ASME above and below ground bulk plant installations. All working components are external to the container connection away from possible product contaminants. Compatible with 1-1/4" FNPT multiple head units including ME902S-16, ME903S-16 & ME904S-16 Series Mini Quad-Port Manifolds.

**MEV250 Series** - Designed for use with storage containers as a primary pressure relief valve on ASME above and below ground installations. All working components and external to the container connection away from possible product contaminants. Compatible with all standard LPG pressure vessels with NPT couplings.

### FEATURES

- Durable single piece anodized aluminum or brass forged body
- Stainless steel internal components
- Standard Seal Material: HNBR (Nitrile) or FKM
- Available Seal Material: FFKM
- Outlet thread accepts MEP178 pipeaway for 2" FNPT pipeaway
- Includes plastic weather cap for relief valve outlet

MEP170



**MEP250**

| Part No.             | STD/PSIG | Seal Material <sup>(3)</sup> | Container Connection | OAL     | Wrench Hex | Flow Capacity SCFM/AIR <sup>(1)</sup> UL @ 120% set pressure | Suitable for tanks w/ surface area up to: <sup>(2)</sup> | Application |                 | Accessories                        |
|----------------------|----------|------------------------------|----------------------|---------|------------|--|--|-------------|-----------------|------------------------------------|
|                      |          |                              |                      |         |            |  |  | LPG         | NH <sub>3</sub> |                                    |
| <b>MEV125B/250</b>   | 250 PSIG | Nitrile                      | 1-1/4" MNPT          | 10-1/2" | 2-11/16"   | 6,330  | 340 Sq. Ft.  | YES         | NO              | MEV125-109 Replacement Cap         |
| <b>MEV125B/265</b>   | 265 PSIG | Nitrile                      | 1-1/4" MNPT          | 10-1/2" | 2-11/16"   | 6,545  | 350 Sq. Ft.  | YES         | NO              |                                    |
| <b>MEV125BVM/250</b> | 250 PSIG | FKM                          | 1-1/4" MNPT          | 10-1/2" | 2-11/16"   | 6,330  | 340 Sq. Ft.  | YES         | NO              |                                    |
| <b>MEV125BVM/265</b> | 265 PSIG | FKM                          | 1-1/4" MNPT          | 10-1/2" | 2-11/16"   | 6,545  | 350 Sq. Ft.  | YES         | NO              |                                    |
| <b>MEV125/250</b>    | 250 PSIG | Nitrile                      | 1-1/4" MNPT          | 10-1/2" | 2-11/16"   | 6,330  | 340 Sq. Ft.  | NO          | YES             | MEP178 Pipeaway Adapter            |
| <b>MEV125/265</b>    | 265 PSIG | Nitrile                      | 1-1/4" MNPT          | 10-1/2" | 2-11/16"   | 6,545  | 350 Sq. Ft.  | NO          | YES             |                                    |
| <b>MEV125VM/250</b>  | 250 PSIG | FKM                          | 1-1/4" MNPT          | 10-1/2" | 2-11/16"   | 6,330  | 340 Sq. Ft.  | YES         | NO              | MEP123 Installation / Removal Tool |
| <b>MEV125VM/265</b>  | 265 PSIG | FKM                          | 1-1/4" MNPT          | 10-1/2" | 2-11/16"   | 6,545  | 350 Sq. Ft.  | YES         | NO              |                                    |
| <b>MEV250VM/250</b>  | 250 PSIG | FKM                          | 2-1/2" MNPT          | 10-1/2" | 4-1/8"     | 10,333   | 610 Sq Ft.   | YES         | NO              | MEP170 Relief Valve Adapter        |
| <b>MEV250CN/250</b>  | 250 PSIG | Nitrile                      | 2-1/2" MNPT          | 10-1/2" | 4-1/8"     | 10,333   | 610 Sq Ft.   | YES         | YES             |                                    |
| <b>MEV250VM/265</b>  | 265 PSIG | FKM                          | 2-1/2" MNPT          | 10-1/2" | 4-1/8"     | 10,948   | 655 Sq Ft.   | YES         | NO              | MEP250 Installation / Removal Tool |
| <b>MEV250CN/265</b>  | 265 PSIG | Nitrile                      | 2-1/2" MNPT          | 10-1/2" | 4-1/8"     | 10,948   | 655 Sq Ft.   | YES         | YES             |                                    |

(1) Flow rates shown are for bare relief valves, pipeways will reduce flow rates.

(2) Per NFPA Code #58, Table 5.9.2.6 (2017 Edition) area shown is for UL or ASME flow rating, whichever is larger.

(3) For FFKM seal materials add "K" after the prefix part number - i.e. MEV125K/250



# DOT FULL INTERNAL PRESSURE RELIEF VALVES

Designed for use on forklift cylinders and other DOT removable cylinders up to 122 pounds of LP-Gas capacity. The working components of this valve are located inside the tank reducing possible malfunction caused by outside debris or other foreign materials.

NOTE: NFPA #58 states, "All containers used in industrial trucks (including fork lift truck cylinders) service shall have the container pressure relief valve replaced by a new or unused valve within 12 years of the date of manufacture of the container and every 10 years thereafter."

## FEATURES

- Stainless steel spring
- Non-adjustable, tamper resistance design
- 45 and 90 degree discharge vents available

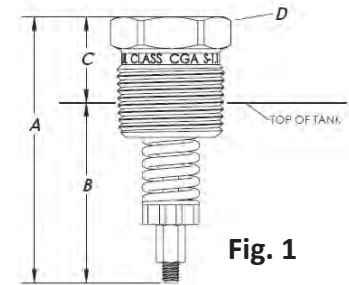

| Dimensions (Approx.) - see Fig. 1 |          |        |         |
|-----------------------------------|----------|--------|---------|
| A                                 | B        | C      | D Hex   |
| 2-5/8"                            | 1-25/32" | 27/32" | 1-1/16" |

| Part No.  | Container Type | Container Connection | Seal Material* | Start-to-Discharge Setting PSIG | UL Flow Capacity SCFM/Air** Per CGA S1.1 @ 480 PSIG | Application | Accessories    |                   |                 |           |
|-----------|----------------|----------------------|----------------|---------------------------------|---|-------------|----------------|-------------------|-----------------|-----------|
|           |                |                      |                |                                 |   |             | Protective Cap | Relief Valve Plug | Discharge Vents |           |
|           |                |                      |                |                                 |   |             |                |                   | 45° Angle       | 90° Angle |
| MEV75FIR* | DOT            | 3/4" MNPT            | FKM            | 375                             | 368   | LPG         | MEP175C        | MEP175P           | MEP175-45       | MEP175-90 |

NOTE: Meets requirements for use on DOT containers with 242 lbs. or less weight of water or 122 lbs or less of LP-Gas  
 \* UL Listed in accordance with Compressed Gas Association Pamphlet S-1.1, Pressure Device Standard for Cylinders;  
 \*\* Flow rates are shown for bare relief valves, pipeways will reduce flow

## FEATURES

- Used as pressure relief device on larger ASME engine fuel containers and recreational vehicle containers
- Use MEVS-PVE445AT on multiport 420-lb. DOT containers
- Protective cap MEPS-UPE16Y included
- Supplied with Everseal™ pre-applied thread sealant

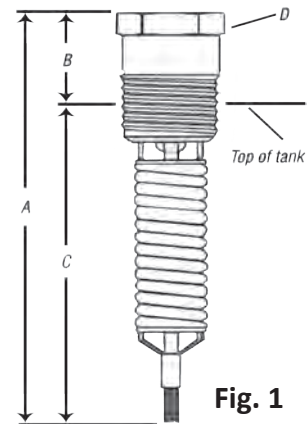
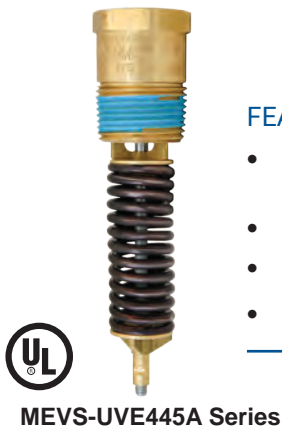

| Dimensions (Approx.) - see Fig. 1 |         |          |         |
|-----------------------------------|---------|----------|---------|
| A                                 | B       | C        | D Hex   |
| 5-9/16"                           | 1-3/32" | 3-15/32" | 1-5/16" |

| Part No.           | STD Setting (PSIG) | Container Connection | Installation Hex | Flow Capacity SCFM/Air ** | Tank Surface Area (Sq. Ft.) | Pipeaway Adapter |
|--------------------|--------------------|----------------------|------------------|---------------------------|-----------------------------|------------------|
|                    |                    |                      |                  | UL @ 120% Set Pressure    |                             |                  |
| MEVS-UVE445AM/250  | 250                | 1" MNPT              | 1-5/16"          | 987                       | 35                          | MEPS-445-21      |
| MEVS-PVE445AT/375* | 375                | 1" MNPT              | 1-5/16"          | 1625                      | 64                          | MEPS-445-21      |

NOTE: Size relief capacity per NFPA Code #58, Table 5.9.2.6 (2017 Edition)  
 \* MEVS-445AT is classified by Underwriters Laboratories Inc. in accordance with CGA Pamphlet S-1.1.  
 \*\* Flow rates are shown as bare relief valves





# FULL INTERNAL PRESSURE RELIEF VALVES

Designed for use in mobile LPG & NH<sub>3</sub> containers as a primary pressure relief valve for bobtail and transport trailer installations. All working components are internal to the container connection preventing damage to the valve should a roll-over occur.

## FEATURES

- Durable stainless steel body construction
- All stainless steel internal components for maximum corrosion resistance
- Available with Nitrile, FKM, or FFKM valve seals
- Large seating surface for superior seal performance & reliability.
- Available with 250 & 265 PSI  LISTED set pressures
- Custom set pressures available

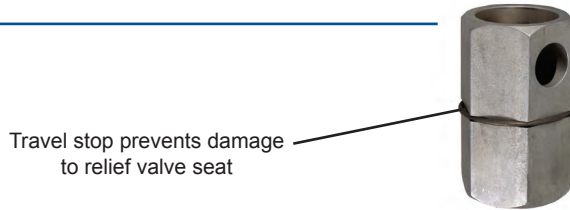

**MEP200FIR/MEP300FIR**  
Hex Installation Tool

## MEV300FIR SERIES



| Part No.                              | STD/<br>PSIG | Container<br>Connection | Installation<br>Hex | Flow<br>Capacity<br>SCFM/Air <sup>(2)</sup> | Service |                   | Seat<br>Material    | Accessories  |                          |
|---------------------------------------|--------------|-------------------------|---------------------|---|---------|-------------------|---------------------|--------------|--------------------------|
|                                       |              |                         |                     | UL @ 120%<br>Set Pressure                   | LPG     | NH <sub>3</sub>   |                     | Cap          | Hex Installation<br>Tool |
| <b>MEV200FIR/250</b> <sup>(4)</sup>   | 250          | 2" MNPT                 | 1-1/2"              | 4,460                                       | Yes     | No <sup>(4)</sup> | Nitrile             | MEV200FIR-09 | MEP200FIR                |
| <b>MEV200FIR/265</b>                  | 265          |                         | 1-1/2"              | 4,670                                       | Yes     | Yes               | Nitrile             |              |                          |
| <b>MEV200FIREP/265</b> <sup>(1)</sup> | 265          |                         | 1-1/2"              | 4,670                                       | No      | Yes               | EPR/<br>EPDM        |              |                          |
| <b>MEV200FIRV/250</b>                 | 250          |                         | 1-1/2"              | 4,460                                       | Yes     | No                | FKM                 |              |                          |
| <b>MEV200FIRV/265</b>                 | 265          |                         | 1-1/2"              | 4,670                                       | Yes     | No                | FKM                 |              |                          |
| <b>MEV200FIRK/250</b> <sup>(1)</sup>  | 250          |                         | 1-1/2"              | 4,460                                       | Yes     | Yes               | FFKM <sup>(3)</sup> |              |                          |
| <b>MEV200FIRK/265</b> <sup>(1)</sup>  | 265          |                         | 1-1/2"              | 4,670                                       | Yes     | Yes               | FFKM <sup>(3)</sup> |              |                          |
| <b>MEV200FIRNP/250</b>                | 250          |                         | 1-1/2"              | 4,670                                       | No      | Yes               | Neoprene            |              |                          |
| <b>MEV200FIRNP/265</b>                | 265          |                         | 1-1/2"              | 4,670                                       | No      | Yes               | Neoprene            |              |                          |
| <b>MEV300FIR/250</b> <sup>(4)</sup>   | 250          | 3" MNPT                 | 2-1/2"              | 10,865                                      | Yes     | No <sup>(4)</sup> | Nitrile             | MEV300FIR-09 | MEP300FIR                |
| <b>MEV300FIR/265</b>                  | 265          |                         | 2-1/2"              | 11,600                                      | Yes     | Yes               | Nitrile             |              |                          |
| <b>MEV300FIREP/265</b> <sup>(1)</sup> | 265          |                         | 2-1/2"              | 11,600                                      | No      | Yes               | EPR/<br>EPDM        |              |                          |
| <b>MEV300FIRK/250</b> <sup>(1)</sup>  | 250          |                         | 2-1/2"              | 10,865                                      | Yes     | Yes               | FFKM <sup>(3)</sup> |              |                          |
| <b>MEV300FIRK/265</b> <sup>(1)</sup>  | 265          |                         | 2-1/2"              | 11,600                                      | Yes     | Yes               | FFKM <sup>(3)</sup> |              |                          |
| <b>MEV300FIRV/250</b>                 | 250          |                         | 2-1/2"              | 10,865                                      | Yes     | No                | FKM                 |              |                          |
| <b>MEV300FIRV/265</b>                 | 265          |                         | 2-1/2"              | 11,600                                      | Yes     | No                | FKM                 |              |                          |
| <b>MEV300FIRNP/250</b> <sup>(1)</sup> | 250          |                         | 2-1/2"              | 10,865                                      | No      | Yes               | Neoprene            |              |                          |
| <b>MEV300FIRNP/265</b> <sup>(1)</sup> | 265          |                         | 2-1/2"              | 11,600                                      | No      | Yes               | Neoprene            |              |                          |

(1) FFKM, Neoprene and EPR/EPDM not UL Listed.

(2) Flow rates are shown for bare relief valves, pipe-aways will reduce flow

(3) Recommended for LPG and NH<sub>3</sub> Dual Service Applications

(4) For NH<sub>3</sub> use add "HN" after the prefix for hydrogenated nitrile part number - i.e. MEV200FIRHN/250

NOTE: Size relief capacity per NFPA Code #58, Table 5.9.2.6 (2017 Edition)



# FLANGED FULL INTERNAL PRESSURE RELIEF

Designed for use in mobile LPG & NH<sub>3</sub> containers as a primary pressure relief valve for bobtail and transport trailer installations. All working components are internal to the container connection preventing damage to the valve should a roll-over incident occur. Our unique design incorporates a standard 3"ANSI - 300LB. raised face flange connection to assure a 100% leak free connection for rugged over the road applications. This eliminates problems associated with NPT threaded connections and/or tank coupling wear due to vibration caused by over the road transit, providing maximum tank and relief valve service life.



MEV300FIR-3F c 

## FEATURES

- Durable single piece stainless steel flanged body construction.
- All stainless steel internal components for maximum corrosion resistance.
- Available with Nitrile, FKM, or FFKM valve seals.
- Large seating surface for superior seal performance & reliability.
- Available with 250 & 265 PSI UL LISTED set pressures.
- Custom set pressures available

| Part No.                        | STD/<br>PSIG | Container Connection | Flow<br>Capacity<br>SCFM/Air <sup>(2)</sup> | Service |                   | Seat<br>Material <sup>(1)</sup> | Accessories  |
|---------------------------------|--------------|----------------------|---|---------|-------------------|---------------------------------|--------------|
|                                 |              |                      | UL @ 120%<br>Set Pressure                   | LPG     | NH <sub>3</sub>   |                                 | Cap          |
| MEV300FIR-3F/250 <sup>(4)</sup> | 250          | 3" 300LB. Flange     | 10,865                                      | Yes     | No <sup>(4)</sup> | Nitrile                         | MEV300FIR-09 |
| MEV300FIR-3F/265                | 265          | 3" 300LB. Flange     | 11,600                                      | Yes     | Yes               | Nitrile                         |              |
| MEV300FIRV-3F/250               | 250          | 3" 300LB. Flange     | 10,865                                      | Yes     | No                | FKM                             |              |
| MEV300FIRV-3F/265               | 265          | 3" 300LB. Flange     | 11,600                                      | Yes     | No                | FKM                             |              |
| MEV300FIRK-3F/250               | 250          | 3" 300LB. Flange     | 10,865                                      | Yes     | Yes               | FFKM <sup>(3)</sup>             |              |
| MEV300FIRK-3F/265               | 265          | 3" 300LB. Flange     | 11,600                                      | Yes     | Yes               | FFKM ~                          |              |

(1) FFKM not UL Listed

(2) Flow rates are shown for bare relief valves.

(3) Recommended for LPG and NH<sub>3</sub> Dual Service Applications

(4) For NH<sub>3</sub> use add "HN" after the prefix for hydrogenated nitrile part number - i.e. MEV300FIRHN-3F/250

NOTE: Size relief capacity per NFPA Code #58, Table 5.9.2.6 (2017 Edition)

# SEMI-INTERNAL PRESSURE RELIEF VALVES

Used as a pressure relief device on stationary ASME containers and domestic tanks

MEVS-UVE433A

MEVS-UVE443A

MEVS-UVE453A



## FEATURES

- Durable all brass body
- Sturdy construction; made with non-corrosive internal materials
- Furnished with rain/dust cap for protection against contamination
- Rain cap also available separately
- Supplied with Everseal™ pre-applied thread sealant

### MEPS-433-45A

Rain/Dust cap with lanyard to minimize cap loss



Protects against contamination

| Part No.           | STD Setting (PSIG) | Container Connection | Installation Hex | Flow Capacity SCFM/Air ** | Tank Surface Area (Sq. Ft.) | Replacement Rain Cap |
|--------------------|--------------------|----------------------|------------------|---------------------------|-----------------------------|----------------------|
|                    |                    |                      |                  | UL @ 120% Set Pressure    |                             |                      |
| MEVS-UVE433AM/250  | 250                | 3/4" MNPT            | 1-11/16"         | 1,930                     | 79                          | MEPS-433-45A         |
| MEVS-UVE433AC/275* | 275                | 3/4" MNPT            | 1-11/16"         | 1,709                     | 68                          | MEPS-433-45A         |
| MEVS-UVE443AM/250  | 250                | 1" MNPT              | 1-7/8"           | 2,755                     | 122                         | MEPS-443-45A         |
| MEVS-UVE443AC/275* | 275                | 1" MNPT              | 1-7/8"           | 2,436                     | 105                         | MEPS-443-45A         |
| MEVS-UVE453AM/250  | 250                | 1-1/4" MNPT          | 2-7/16"          | 4,640                     | 230                         | MEPS-453-45A         |
| MEVS-UVE453AC/275* | 275                | 1-1/4" MNPT          | 2-7/16"          | 4,406                     | 216                         | MEPS-453-45A         |

\* California setting 275 psig

\*\* Flow rates are shown as bare relief valves

NOTE: Size relief capacity per NFPA Code #58, Table 5.9.2.6 (2017 Edition)

## UNIVERSAL RELIEF VALVE COVERS

These covers are intended to protect both internal & external relief valves ranging in size from 1/2" to 1-1/4" NPT from moisture and/or other possible contaminants. Using the universal "shower cap" style relief valve covers will allow technicians to carry two sizes that will protect the majority of domestic tank relief valves.

## FEATURES

- Made with durable UV stable yellow vinyl material
- Fits 1/2" to 1-1/4" NPT internal and external relief valves



MEH502



MEH503

| Part No. | Description                                  | Material     |
|----------|--|--------------|
| MEH502   | Adjustable Relief Valve Cover 1/2" to 3/4"   | Yellow Vinyl |
| MEH503   | Adjustable Relief Valve Cover 3/4" to 1-1/4" | Yellow Vinyl |



# SEMI-INTERNAL PRESSURE RELIEF VALVES

Designed for use in large stationary LPG containers as a primary pressure relief valve. These pressure relief valves have been specifically designed to provide optimum performance when installed in either a 2" half or full coupling making them perfect for most large stationary tank installations.



MEV200SIR MEV200SSIR

NOTE: Available with all stainless steel components for NH<sub>3</sub> stationary container service applications.

## FEATURES

- Durable forged brass body with 3" NPT outlet pipeaway thread
- All stainless steel stem, spring, and valve gasket holder for maximum corrosion resistance
- Available with Nitrile, FKM, or FFKM valve seals
- Large seating surface for superior seal performance & reliability
- Available with 125, 250, 265 PSI UL LISTED set pressures
- Custom set pressures available



| Part No.         | STD/<br>PSIG | Container<br>Connection | Pipeaway<br>Connection | Installation<br>Hex | Flow<br>Capacity<br>SCFM/Air** | Service |                 | Seat<br>Material* | Accessories                                     |
|------------------|--------------|-------------------------|------------------------|---------------------|--------------------------------|---------|-----------------|-------------------|---|
|                  |              |                         |                        |                     |                                | LPG     | NH <sub>3</sub> |                   |   |
| MEV200SIR/125    | 125          | 2"MNPT                  | 3"MNPT                 | 3-1/2"              | 4,870                          | Yes     | No              | Nitrile           | MEV200SIR-106<br>(Cap & Lanyard)                |
| MEV200SIR/250    | 250          | 2"MNPT                  | 3"MNPT                 | 3-1/2"              | 10,925                         | Yes     | No              | Nitrile           |   |
| MEV200SSIR/250   | 250          | 2"MNPT                  | 3"MNPT                 | 3-1/2"              | 10,925                         | Yes     | Yes             | Nitrile           |   |
| MEV200SIR/265    | 265          | 2"MNPT                  | 3"MNPT                 | 3-1/2"              | 11,475                         | Yes     | No              | Nitrile           |   |
| MEV200SSIR/265   | 265          | 2"MNPT                  | 3"MNPT                 | 3-1/2"              | 11,475                         | Yes     | Yes             | Nitrile           |   |
| MEV200SIRV/125   | 125          | 2"MNPT                  | 3"MNPT                 | 3-1/2"              | 4,870                          | Yes     | No              | FKM               |   |
| MEV200SIRV/250   | 250          | 2"MNPT                  | 3"MNPT                 | 3-1/2"              | 10,925                         | Yes     | No              | FKM               |   |
| MEV200SSIRV/250  | 250          | 2"MNPT                  | 3"MNPT                 | 3-1/2"              | 10,925                         | Yes     | Yes             | FKM               |   |
| MEV200SIRV/265   | 250          | 2"MNPT                  | 3"MNPT                 | 3-1/2"              | 11,475                         | Yes     | No              | FKM               |   |
| MEV200SSIRV/265  | 250          | 2"MNPT                  | 3"MNPT                 | 3-1/2"              | 11,475                         | Yes     | Yes             | FKM               |   |
| MEV200SIRK/125*  | 125          | 2" MNPT                 | 3"MNPT                 | 3-1/2"              | 4,870                          | Yes     | No              | FFKM              | MEP104-24<br>(Pipeaway adapter)<br>see page 128 |
| MEV200SIRK/250*  | 250          | 2" MNPT                 | 3"MNPT                 | 3-1/2"              | 10,925                         | Yes     | No              | FFKM              |   |
| MEV200SSIRK/250* | 250          | 2" MNPT                 | 3"MNPT                 | 3-1/2"              | 10,925                         | Yes     | Yes             | FFKM              |   |
| MEV200SIRK/265*  | 265          | 2" MNPT                 | 3"MNPT                 | 3-1/2"              | 11,475                         | Yes     | No              | FFKM              |   |
| MEV200SSIRK/265* | 265          | 2" MNPT                 | 3"MNPT                 | 3-1/2"              | 11,475                         | Yes     | Yes             | FFKM              |   |

\* FFKM not UL Listed

\*\* Flow rates are shown as bare relief valves.

NOTE: Size relief capacity per NFPA Code #58, Table 5.9.2.6 (2017 Edition)



# HYDROSTATIC PRESSURE RELIEF VALVES

Designed to protect piping and shutoff valves from over pressure situations where liquid LP-Gas or NH<sub>3</sub> has the potential to be trapped. These relief valves provide pressure relief at or in excess of the stated pressure setting, protecting against line or plumbing system failures.

NOTE: NFPA #58 states, "Hydrostatic relief valves designed to relieve the hydrostatic pressure that can develop in sections of liquid piping between closed shutoff valves shall have pressure settings not less than 400 psig or more than 500 psig unless installed in systems designed to operate above 350 psig. Hydrostatic relief valves for use in systems designed to operate above 350 psig shall have settings not less than 110 percent or more than 125 percent of the system design pressure."

## FEATURES

- Compact design to fit any application
- Stainless steel spring
- Non-adjustable, tamper resistant design
- Stainless steel models rated for LP-Gas & NH<sub>3</sub>
- Specially designed internal components to increase flow at discharge

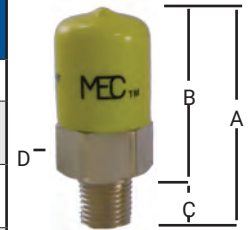

| Part No.     | Body Material   | Seal Material | Start-to-Discharge Setting PSIG | Inlet MNPT | A        | B        | C    | D          | Accessory       |
|--------------|-----------------|---------------|---------------------------------|------------|----------|----------|------|------------|-----------------|
|              |                 |               |                                 |            |          |          |      |            | Pipeway Adapter |
| MEH225       | Brass           | Nitrile       | 440                             | 1/4"       | 1-1/16"  | 13/16"   | 1/4" | 9/16" Hex  | —               |
| MEH225SS/350 | Stainless Steel | Nitrile       | 350****                         | 1/4"       | 1-1/16"  | 13/16"   | 1/4" | 9/16" Hex  | —               |
| MEH225SS/400 | Stainless Steel | Nitrile       | 400                             | 1/4"       | 1-1/16"  | 13/16"   | 1/4" | 9/16" Hex  | —               |
| MEH225SS     | Stainless Steel | Nitrile       | 440                             | 1/4"       | 1-1/16"  | 13/16"   | 1/4" | 9/16" Hex  | —               |
| MEH25/450    | Brass           | Nitrile       | 450                             | 1/4"       | 1-59/64" | 1-43/64" | 1/4" | 7/8" Hex   | MEP173*         |
| MEH25K/450   | Brass           | FFKM          | 450                             | 1/4"       | 1-59/64" | 1-43/64" | 1/4" | 7/8" Hex   | MEP173*         |
| MEH25V/450   | Brass           | FKM           | 450                             | 1/4"       | 1-59/64" | 1-43/64" | 1/4" | 7/8" Hex   | MEP173*         |
| MEH50/460    | Brass           | Nitrile       | 460                             | 1/2"       | 2-1/2"   | 2-1/8"   | 3/8" | 1-1/8" Hex | MEP174**        |
| MEH75/460    | Brass           | Nitrile       | 460                             | 3/4"       | 2-21/32" | 2-5/32"  | 1/2" | 1-1/8" Hex | MEP174**        |
| MEJ602H***   | Brass           | Nitrile       | 440                             | 1/4"       | —        | —        | —    | —          | —               |

\* 1/4" FNPT Outlet; \*\* 1/2" FNPT Outlet; \*\*\* Factory Installed Vent Valve; \*\*\*\* Special Applications

## UNIVERSAL RELIEF VALVE COVERS

These protective caps are made of durable, fade resistant vinyl. All relief valves must have a protective cap to keep debris and water out of the valve.



MEH501

| Part No.     | Cap ID | Cap Height | Replacement Protective Cap for Part No. |
|--------------|--------|------------|---|
| MEH501-.437  | .437"  | 3/8"       | MEH225<br>MEH225SS Series               |
| MEH501-.812  | .812"  | 1"         | MEH25/450                               |
| MEH501-1.062 | 1.062" | 3/4"       | MEH50/460<br>MEH75/460                  |
| MEH501-1.5   | 1.50"  | 1"         | —                                       |

\* With Lanyard

| Part No.     | Cap ID | Cap Height | Replacement Protective Cap for Part No. |
|--------------|--------|------------|---|
| MEH501-1.75  | 1.75"  | 1"         | —                                       |
| MEH501-2.25  | 2.25"  | 1"         | —                                       |
| MEH501-2.625 | 2.625" | 1"         | —                                       |
| MEV250-013*  | 3.974  | 1/2"       | MEV250 Series                           |



# MULTIPURPOSE FILLER BYPASS RETURN VALVE

## for DISPENSING APPLICATIONS

Ideally suited for use as a high capacity combination double check fill and liquid bypass return line shut-off valve. These valves are equipped standard with an integrated excess flow feature that is internal to the tank protecting against tank separation. The preinstalled side mounted ME601-6 double check fill valve allows for safe low emissions container filling at a convenient right angle orientation. The top mount 3/4" FNPT port above integrated shut-off valve seat allows for maximum liquid bypass return flow rates without adding an external line shut-off valve.

NOTE: For proper operation and performance of the excess flow feature the manual shutoff must be completely open and back-seated.

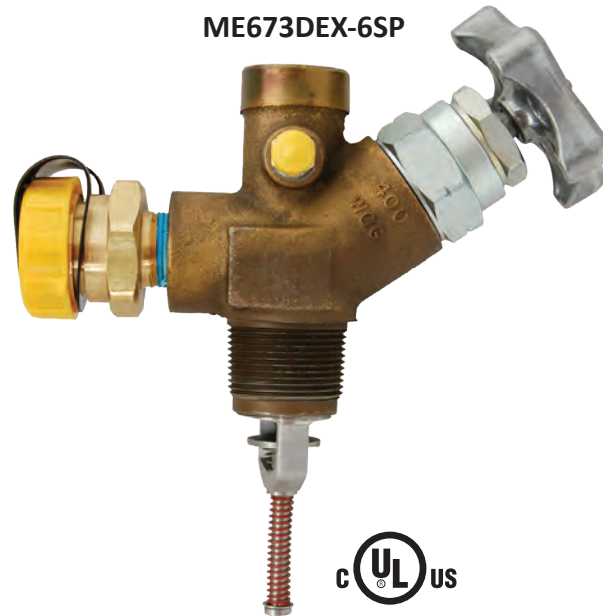

### FEATURES

- Plated ductile iron body with preinstalled MEH225 hydrostatic relief valve
- All stainless steel internal construction for maximum corrosion resistance
- V-cup PTFE packing stem seals
- Rated 400 PSI / WOG
- Preinstalled ME601-6 double check fill valve w/ cap
- FOR USE WITH LPG ONLY (this configuration contains brass components)

| MEC Multipurpose Filler Bypass Return Valve |                        |                           |                           |                                      |                  |                    |
|---|------------------------|---------------------------|---------------------------|--------------------------------------|------------------|--------------------|
| Part No.                                    | Tank Connection (MNPT) | Fill Connection (M. Acme) | Bypass Return Port (FNPT) | Approximate Excess Flow Closing Flow |                  | Hydrostatic Relief |
|   |                        |                           |                           | *Liquid GPM/LPG                      | **Vapor SCFH/LPG |                    |
| ME673DEX-6SP                                | 1-1/4"                 | 1-3/4"                    | 3/4"                      | 58                                   | 27,000           | MEH225             |

\* For NH<sub>3</sub> Flow Rates Multiply by .90

\*\* For NH<sub>3</sub> @ 100 PSI, Multiply by 1.6

NOTE: For use with LPG only

# MULTI-PURPOSE VALVES

Intended for use as a high capacity filler valve with a manual shut-off device in LPG or NH<sub>3</sub> containers. These valves can be equipped with either a soft seat back check or excess flow feature that is internal to the container. The excess flow version can also be used as a vapor equalizing valve typically found in NH<sub>3</sub> applicators and nurse tank applications.

NOTE: For proper operation and performance of the excess flow feature the manual shutoff must be completely open and back seated.



## FEATURES

- Plated ductile iron body with 1/4" NPT auxillary plugged port
- All stainless steel internal construction for maximum corrosion resistance
- Supplied with ACME cap & chain assembly
- V-cup PTFE packing stem seals
- Rated 400 PSI / WOG
- Removable data plate

| MEC Multipurpose Filler / Withdrawal Valves |              |                           |                                      |                                      |                               |            |                       |                       |
|---|--------------|---------------------------|--------------------------------------|--------------------------------------|-------------------------------|------------|-----------------------|-----------------------|
| Part No.                                    | Inlet (MNPT) | Fill Connection (M. Acme) | <sup>(1)</sup> GPM/LPG Fill Capacity | Approximate Excess Flow Closing Flow |                               | Back Check | Accessories           |                       |
|   |              |                           |                                      | <sup>(1)</sup> Liquid GPM/LPG        | <sup>(2)</sup> Vapor SCFH/LPG |            | Hydrostatic Relief    | Vent Valve            |
| ME670DBC                                    | 1-1/4"       | 1-3/4"                    | 100                                  | N/A                                  | N/A                           | Yes        | MEH225 <sup>(3)</sup> | MEJ400 <sup>(3)</sup> |
|   |              |                           |                                      |                                      |                               |            | MEH225SS              | MEJ402S               |
| ME670DEX <sup>(4)</sup>                     | 1-1/4"       | 1-3/4"                    | 100                                  | 58                                   | 27,000                        | No         | MEH225 <sup>(3)</sup> | MEJ400 <sup>(3)</sup> |
|   |              |                           |                                      |                                      |                               |            | MEH225SS              | MEJ402S               |

(1) For NH<sub>3</sub> Flow Rates Multiply by .90  
 (2) For NH<sub>3</sub> @ 100 PSI, Multiply by 1.6

(3) Brass accessories cannot be used for NH<sub>3</sub>  
 (4) Available for 45 GPM NH<sub>3</sub> closing flow - e.i. ME670DEX/45

The ME671DIBC is equipped with an integrated back check (IBC) feature built into the lower portion of the seat disc assembly. This feature allows liquid pressure built upstream of the shut-off disc assembly to automatically be relieved back to the container when line pressures exceed 10-25 PSI over container pressure. The (IBC) feature greatly reduces product emissions and increases overall system safety.



| Part No.                   | Inlet (MNPT) | Withdrawal (FNPT) | Approximate Excess Flow Closing Flow Liquid GPM/LPG <sup>(1)</sup> | Integrated Back Check | Accessories           |                       |
|----------------------------|--------------|-------------------|--|-----------------------|-----------------------|-----------------------|
|                            |              |                   |  |                       | Hydrostatic Relief    | Vent Valve            |
| ME671DIBC-6                | 1-1/4"       | 3/4"              | 50   | Yes                   | N/A                   | MEJ400 <sup>(2)</sup> |
|                            |              |                   |  |                       | N/A                   | MEJ402S               |
| ME671DIBC-8 <sup>(3)</sup> | 1-1/4"       | 1"                | 58   | Yes                   | N/A                   | MEJ400 <sup>(2)</sup> |
|                            |              |                   |  |                       | N/A                   | MEJ402S               |
| ME671D-6                   | 1-1/4"       | 3/4"              | 50   | No                    | MEH225 <sup>(2)</sup> | MEJ400 <sup>(2)</sup> |
|                            |              |                   |  |                       | MEH225SS              | MEJ402S               |
| ME671D-8 <sup>(3)</sup>    | 1-1/4"       | 1"                | 58   | No                    | MEH225 <sup>(2)</sup> | MEJ400 <sup>(2)</sup> |
|                            |              |                   |  |                       | MEH225SS              | MEJ402S               |
| ME672D                     | 1-1/4"       | 1"                | 78   | No                    | MEH225 <sup>(2)</sup> | MEJ400 <sup>(2)</sup> |
|                            |              |                   |  |                       | MEH225SS              | MEJ402S               |

(1) For NH<sub>3</sub> Flow Rates Multiply by .90  
 (2) Brass accessories cannot be used for NH<sub>3</sub> service  
 (3) Available for 45 GPM NH<sub>3</sub> closing flow - e.i. ME671D-8/45



# MULTI-PURPOSE FILLER/WITHDRAWAL VALVES

Intended for use as a high capacity combination filler and liquid withdrawal valve with a manual shut off device in LPG or NH<sub>3</sub> containers. These valves can be equipped with either a soft seat back check or excess flow feature that is internal to the container. Ideally suited for use in dispensing applications as a dual purpose high capacity tank filler valve as well as a liquid return line from the pump bypass valve.

NOTE: For proper operation and performance of the excess flow feature the manual shutoff must be completely open and back seated.

## FEATURES

- Plated ductile iron body with 1/4" NPT auxillary plugged port
- All stainless steel internal construction for maximum corrosion resistance
- Supplied with ACME cap & chain assembly
- V-cup PTFE packing stem seals
- Rated 400 PSI / WOG
- Removable data plate

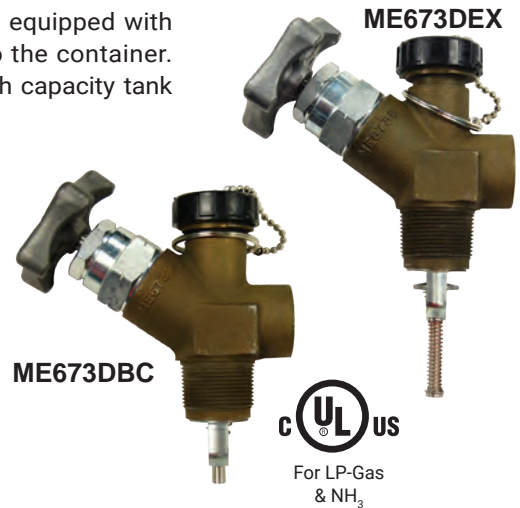

ASME / DOT CONTAINER VALVES

| Part No.                  | Inlet (MNPT) | Fill Connection (M. Acme) | Withdrawal (FNPT) | <sup>(1)</sup> Fill Capacity GPM/LPG | Approximate Excess Flow Closing Flow |                               | Back Check | Accessories           |                       |
|---------------------------|--------------|---------------------------|-------------------|--------------------------------------|--------------------------------------|-------------------------------|------------|-----------------------|-----------------------|
|                           |              |                           |                   |                                      | <sup>(1)</sup> Liquid GPM/LPG        | <sup>(2)</sup> Vapor SCFH/LPG |            | Hydrostatic Relief    | Vent Valve            |
| ME673DEX-6 <sup>(4)</sup> | 1-1/4"       | 1-3/4"                    | 3/4"              | 100                                  | 58                                   | 27,000                        | No         | MEH225 <sup>(3)</sup> | MEJ400 <sup>(3)</sup> |
|                           |              |                           |                   |                                      |                                      |                               |            | MEH225SS              | MEJ402S               |
| ME673DEX-8 <sup>(4)</sup> | 1-1/4"       | 1-3/4"                    | 1"                | 100                                  | 58                                   | 27,000                        | No         | MEH225 <sup>(3)</sup> | MEJ400 <sup>(3)</sup> |
|                           |              |                           |                   |                                      |                                      |                               |            | MEH225SS              | MEJ402S               |
| ME673DBC-6                | 1-1/4"       | 1-3/4"                    | 3/4"              | 100                                  | N/A                                  | N/A                           | Yes        | MEH225 <sup>(3)</sup> | MEJ400 <sup>(3)</sup> |
|                           |              |                           |                   |                                      |                                      |                               |            | MEH225SS              | MEJ402S               |
| ME673DBC-8                | 1-1/4"       | 1-3/4"                    | 1"                | 100                                  | N/A                                  | N/A                           | Yes        | MEH225 <sup>(3)</sup> | MEJ400 <sup>(3)</sup> |
|                           |              |                           |                   |                                      |                                      |                               |            | MEH225SS              | MEJ402S               |

(1) For NH<sub>3</sub> Flow Rates Multiply by .90  
 (2) For NH<sub>3</sub> @ 100 PSI, Multiply by 1.6

(3) Brass accessories cannot be used for NH<sub>3</sub>  
 (4) Available for 45 GPM NH<sub>3</sub> closing flow - e.i. ME673DEX-6/45

# ASME TANK FILLER VALVES

Designed to allow maximum product transfer with its manually operated open throat design. These valves have an integral high flow primary soft-seat back check and a manually operated secondary shutoff valve for maximum protection against leaks. Because these valves provide a manually operated shutoff device, the need for a flow restricting fill check adapter has been eliminated.

## FEATURES

- Allows **25-50%** more product flow during filling operations
- Manual valve portion assures operator when valve is open or closed
- Removable key provided to help prevent tampering
- Constructed with a durable Nitrile O-ring primary back check seal and reliable PTFE packing for secondary manual valve seal
- Durable all brass construction for maximum weather and spark resistance



**ME600-10**  
Patent Pending

| Part No. | Filler Valve MNPT | Hose End M. Acme Connection | Protective Cap Included | Additional Keys |
|----------|-------------------|-----------------------------|-------------------------|-----------------|
| ME600-6  | 3/4"              | 1-3/4"                      | Yes                     | ME578-02        |
| ME600-10 | 1-1/4"            | 1-3/4"                      | Yes                     | ME578-02        |

NOTE: Both models include manual shutoff





# DOUBLE CHECK FILL VALVES

Designed for DOT forklift, engine fuel and ASME residential tanks, these double check filler valves automatically open with pump pressure providing maximum product flow rates. Once flow ceases, both upper and lower check mechanisms close to prevent product loss from the container. The lower check serves as a secondary seat to limit product loss in the event that the primary upper seat fails to operate properly due to damage.



## FEATURES

- Industry best flow rate
- Resilient bonded main valve seal
- Integral break away feature leaves primary check intact in the event of delivery truck roll away
- Field repairable upper check seat
- Factory applied thread sealant



**ME601-6**



**ME601-10**

| Part No.        | Description   | Flow Rate LPG |        | Accessories   |
|-----------------|---|---------------|--------|---------------|
|                 |   | 10 PSI        | 20 PSI | Cap & Lanyard |
| <b>ME601-6</b>  | 1-3/4" M. Acme x 3/4" MNPT Double Fill Valve w/ Cap & Lanyard   | 11            | 24     | ME601-902     |
| <b>ME601-10</b> | 1-3/4" M. Acme x 1-1/4" MNPT Double Fill Valve w/ Cap & Lanyard | 22            | 36     | ME601-902     |

# VAPOR EQUALIZING VALVES

MEC vapor equalizing valves can be purchased in single or double check versions. The single check version can be used to facilitate pressure equalization of lines or containers but must not be installed directly into the container. A properly sized excess flow device must first be installed into container openings for compliance with NFPA Pamphlet #58. Double check versions consist of both an upper and lower check assembly. The upper check can be opened with vapor equalizing hose couplings equipped with projecting nozzle tips where the lower check is a normally open excess flow type. The lower excess flow check assembly automatically closes when flow out of the container exceeds its rated capacity. MEC double check vapor equalizing valves feature a two piece body construction where the upper check can be repaired while in service with minimal leakage from the container.

## FEATURES

- High Flow construction
- Resilient bonded main valve seal
- Integral break away feature leaves primary check intact in the event of delivery truck roll away
- Field repairable upper check seat



**ME664**  
Single Check Valve



**ME663**  
Double Check Valve

| Part No.     | Description   | Closing Flow   |
|--------------|---|----------------|
| <b>ME663</b> | Double Check Vapor Return Valve 3/4" MNPT x 1-1/4" M. ACME w/ Plastic Cap | 4,000 SCFH/LPG |
| <b>ME664</b> | Single Check Vapor Return Valve 3/4" MNPT x 1-1/4" M. ACME w/ Plastic Cap | N/A            |



# ASME/DOT CONTAINER SERVICE VALVES

Intended for use in vapor withdrawal service for ASME and DOT containers or as fuel line shutoff valves.

NOTE: These valves do not incorporate an integral pressure relief valve and are intended for use in containers that have a separate stand alone pressure relief valve sized to properly handle the container's capacity.

## FEATURES

- One piece forged brass body construction
- Dual O-ring packing design
- Easy to repair / replace bonnet assembly
- Universal bonnet assembly
- Industry best fill flow rate
- Factory applied thread sealant

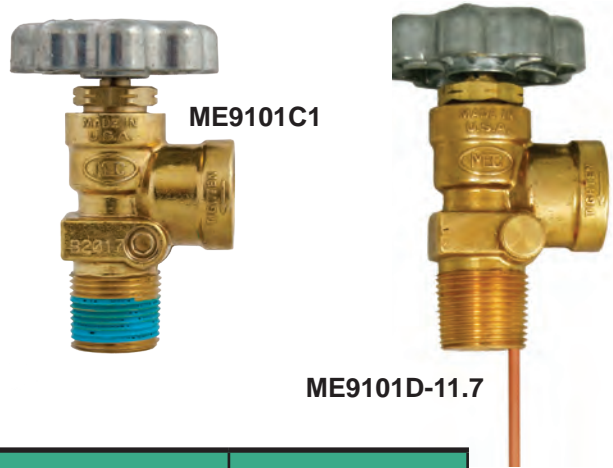

| Part No.     | Description  | Dip Tube Length |
|--------------|--|-----------------|
| ME9101C1     | 3/4" MNPT X F. POL ASME/ DOT Service Valve (No Dip Tube)   | N/A             |
| ME9101D-11.1 | 3/4" MNPT X F. POL ASME/ DOT Service Valve (with Dip Tube) | 11.1"           |
| ME9101D-11.7 | 3/4" MNPT X F. POL ASME/ DOT Service Valve (with Dip Tube) | 11.7"           |

# ASME TANK MANIFOLDING SERVICE VALVES

Intended for use in vapor withdrawal service for ASME tanks where more than one vessel is installed. The internal excess flow device at the inlet of the shutoff valve provides excess flow protection in the event of a downstream line break.

NOTE: These valves do not incorporate an integral pressure relief valve or double check fill valve and are intended for use in containers that have a stand-alone pressure relief valve sized to properly handle the container's capacity and a separate double check fill valve.

## FEATURES

- One piece forged brass body construction
- Dual O-ring packing design
- Easy to repair / replace bonnet assembly
- Universal bonnet assembly
- Industry best fill flow rate
- Factory applied thread sealant
- Heavy duty replaceable zinc hand wheel
- ASME Compliant

| Part No. | Description  | Excess Flow GPM |
|----------|--|-----------------|
| ME9101C5 | 3/4" MNPT X F. POL ASME/ DOT Container Service Valve | 2.6 GPM         |

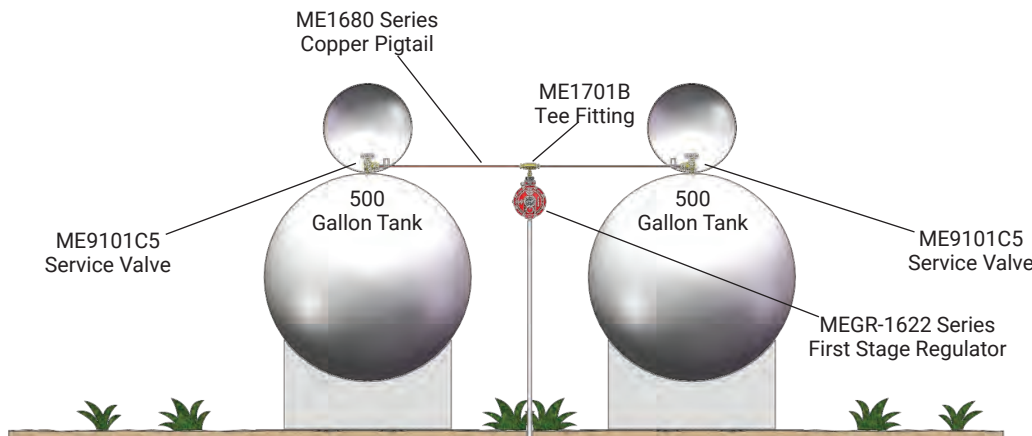

# MULTI-SERVICE VAPOR VALVES

## for ASME CYLINDERS

The **ME662 Series Multi-Service Valve** is intended for use in vapor withdrawal service for ASME containers or as fuel line shutoff valves in combination with an integral double check fill and vapor equalization valve.

| Part No.       | Inlet       | Outlet | Vent Type | Diptube Length |
|----------------|-------------|--------|-----------|----------------|
| <b>ME662</b>   | 1-1/2" MNPT | F. POL | MEJ401    | 16.0"          |
| <b>ME662SC</b> | 1-1/2" MNPT | F. POL | MEJ401SC  | 16.0"          |

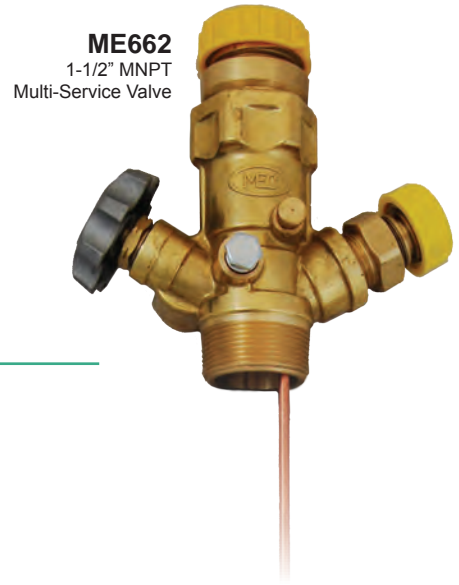

### FEATURES

- One piece forged brass body construction
- Dual o-ring packing design
- Easy to repair / replace bonnet assembly
- Universal bonnet assembly
- Heavy duty replaceable zinc hand wheel
- Plugged test port: ME662 Series - 1/4" FNPT  
ME665 Series - 1/8" FNPT
- SC model features optional self-cleaning LE thumb screw vent

The **ME665 Series Multi-Service Valve** is intended for use in vapor withdrawal service for ASME containers or as fuel line shutoff valves in combination with an integral double check vapor equalization valve.

| Part No.*      | Inlet     | Outlet | Vent Type | Diptube Length |
|----------------|-----------|--------|-----------|----------------|
| <b>ME665</b>   | 3/4" MNPT | F. POL | MEJ401    | 12.0"          |
| <b>ME665SC</b> | 3/4" MNPT | F. POL | MEJ401SC  | 12.0"          |



**ME665**  
3/4" MNPT Multi-Service Valve

NOTE: ME662 & ME665 series valves do not incorporate an integral pressure relief valve or double check fill valve and are intended for use in containers that have a stand-alone pressure relief valve sized to properly handle the container's capacity and a separate double check fill valve.



# VAPOR WITHDRAWAL VALVES

## for DOT 100 LB. CYLINDERS

Intended for use in vapor withdrawal service for DOT containers up to 100 lb. LPG capacity as fuel line shutoff valves in combination with a liquid fill and vapor relief valve.

### FEATURES

- One piece forged brass body construction
- Easy to repair / replace bonnet assembly
- Integral 375 PSI relief valve (Propylene service - 435 PSI)
- Heavy duty replaceable zinc hand wheel
- Optional MEJ401SC self-cleaning LE fixed liquid level vent screw
- F. POL vapor outlet with shutoff
- Available in vapor seal construction for propylene service
- Diptubes can be cut to length for specific tank needs

**MES-PVE3250CLG-10.6**  
100 LB. Vapor Service Valve



| Part No.*             | Descriptions                               | Container Type | Relief STD PSI | Vent Type | Diptube |
|-----------------------|--|----------------|----------------|-----------|---------|
| MES-PVE3250BC-312     | Service Vapor 3/4" NGT X F. POL (705 SCFM) | ASME           | 312            | N/A       | N/A     |
| MES-PVE3250C-375      | Service Vapor 3/4" NGT X F. POL            | DOT            | 375            | N/A       | N/A     |
| MES-PVE3250CV-435     | Propylene Service Vapor 3/4" NGT X F. POL  | DOT            | 435            | N/A       | N/A     |
| MES-PVE3250CLG-375    | Service Vapor 3/4" NGT X F. POL            | DOT            | 375            | MEJ401    | N/A     |
| MES-PVE3250CLGV-435   | Propylene Service Vapor 3/4" NGT X F. POL  | DOT            | 435            | MEJ401    | N/A     |
| MES-PVE3250CLGSC-375  | Service Vapor 3/4" NGT X F. POL            | DOT            | 375            | MEJ401SC  | N/A     |
| MES-PVE3250CLG-10.6   | Service Vapor 3/4" NGT X F. POL            | DOT            | 375            | MEJ401    | 10.6"   |
| MES-PVE3250CLGV-10.6  | Propylene Service Vapor 3/4" NGT X F. POL  | DOT            | 435            | MEJ401    | 10.6"   |
| MES-PVE3250CLGSC-10.6 | Service Vapor 3/4" NGT X F. POL            | DOT            | 375            | MEJ401SC  | 10.6"   |
| MES-PVE3250CLG-11.6   | Service Vapor 3/4" NGT X F. POL            | DOT            | 375            | MEJ401    | 11.6"   |
| MES-PVE3250CLGV-11.6  | Propylene Service Vapor 3/4" NGT X F. POL  | DOT            | 435            | MEJ401    | 11.6"   |
| MES-PVE3250CLGSC-11.6 | Service Vapor 3/4" NGT X F. POL            | DOT            | 375            | MEJ401SC  | 11.6"   |

# LIQUID WITHDRAWAL VALVES

## for DOT 100LB. CYLINDERS

Intended for use in liquid withdrawal service for DOT containers up to 100 lb. LPG capacity as fuel line shutoff valves in combination with a liquid fill and vapor relief valve.

**MES-PVE3250CLM-11.6**  
100 LB. Liquid Service Valve



### FEATURES

- One piece forged brass body construction
- Easy to repair / replace bonnet assembly
- Integral 375 PSI relief valve - 366 SCFM Air
- Heavy duty replaceable zinc hand wheel
- Optional MEJ401SC self-cleaning LE fixed liquid level vent screw
- Male CGA555 liquid outlet with shutoff
- Integral 1.0 GPM/LPG excess flow valve
- Diptubes can be cut to length for specific tank needs

| Part No.*              | Descriptions                        | Container Type | Relief STD PSI | Withdrawal Tube Width | Vent Type | Diptube |
|------------------------|-------------------------------------|----------------|----------------|-----------------------|-----------|---------|
| MES-PVE3250CLM-375     | Service Liquid 3/4" NGT X M. CGA555 | DOT            | 375            | 1/4"                  | MEJ401    | N/A     |
| MES-PVE3250CLM-11.6    | Service Liquid 3/4" NGT X M. CGA555 | DOT            | 375            | 1/4"                  | MEJ401    | 11.6"   |
| MES-PVE3250CLM-11.6SP* | Service Liquid 3/4" NGT X M. CGA555 | DOT            | 375            | 1/4"                  | MEJ401    | 11.6"   |
| MES-PVE3250CLMSC-11.6  | Service Liquid 3/4" NGT X M. CGA555 | DOT            | 375            | 1/4"                  | MEJ401SC  | 11.6"   |

\* Includes remote bleeder valve for butane



# MULTI-SERVICE VAPOR VALVES

## for DOT 200LB. CYLINDERS

Intended for use in vapor withdrawal service for DOT containers up to 200 lb. LPG capacity as fuel line shutoff valves in combination with a fill and vapor relief valve. Ideal for on-site filling without interruption of service by combining all functions into a single 3/4" NPT tank opening.

**MES-PVE2030BC** Multi-Service Valve



### FEATURES

- One piece forged brass body construction
- Integral Fill Valve
- Easy to repair / replace bonnet assembly
- Integral 375 PSI relief valve
- Heavy duty replaceable zinc hand wheel
- Liquid splash tube to prevent liquid in vapor opening
- Optional MEJ401SC self-cleaning LE fixed liquid level vent screw
- F. POL vapor outlet with shutoff

| Part No.*            | Fill Connection | Inlet    | Outlet            | Vent Type | Diptube Length | Relief STD PSI |
|----------------------|-----------------|----------|-------------------|-----------|----------------|----------------|
| MES-PVE2030BC-10.6   | 1-3/4" ACME     | 3/4" NGT | F. POL w/ Shutoff | –         | 10.6"          | 375            |
| MES-PVE2030BCSC-10.6 | 1-3/4" ACME     | 3/4" NGT |                   | MEJ401SC  | 10.6"          | 375            |
| MES-PVE2030BC-11.2   | 1-3/4" ACME     | 3/4" NGT |                   | –         | 11.2"          | 375            |
| MES-PVE2030BCSC-11.2 | 1-3/4" ACME     | 3/4" NGT |                   | MEJ401SC  | 11.2"          | 375            |
| MES-PVE2030BC-11.6   | 1-3/4" ACME     | 3/4" NGT |                   | –         | 11.6"          | 375            |
| MES-PVE2030BCSC-11.6 | 1-3/4" ACME     | 3/4" NGT |                   | MEJ401SC  | 11.6"          | 375            |
| MES-PVE2030BC-8.6    | 1-3/4" ACME     | 3/4" NGT |                   | –         | 8.6"           | 375            |
| MES-PVE2030BCSC-8.6  | 1-3/4" ACME     | 3/4" NGT |                   | MEJ401SC  | 8.6"           | 375            |

# MULTI-SERVICE VAPOR VALVES

Intended for use in vapor withdrawal service for DOT or ASME containers ranging from 420 lbs. to 100 gallons LPG capacity as fuel line shutoff valves in combination with a fill and vapor relief valve. Ideal for on-site filling without interruption of service by combining all functions into a single 1" tank opening.



**MES-PVE2035AT**  
Multi-Service Valve

## FEATURES

- One piece forged brass body construction
- Integral Fill Valve
- Easy to repair / replace bonnet assembly
- Integral 375 PSI or 250 PSI relief valve
- Heavy duty replaceable zinc hand wheel
- 1/8" FNPT plugged test port
- Optional MEJ401SC self-cleaning LE fixed liquid level vent screw
- Liquid splash tube to prevent liquid in vapor opening
- F. POL vapor outlet with shutoff

| Part No.*                | Filler Connection | Inlet  | Outlet | Diptube Length | Relief STD PSI | Vent Type |
|--------------------------|-------------------|--------|--------|----------------|----------------|-----------|
| MES-PVE2035AT-11.2       | 1-3/4" ACME       | 1" NGT | F. POL | 11.2"          | 375            | –         |
| MES-PVE2035ATSC-11.2     | 1-3/4" ACME       | 1" NGT | F. POL | 11.2"          | 375            | MEJ401SC  |
| MES-PVE2035AT-11.7       | 1-3/4" ACME       | 1" NGT | F. POL | 11.7"          | 375            | –         |
| MES-PVE2035ATSC-11.7     | 1-3/4" ACME       | 1" NGT | F. POL | 11.7"          | 375            | MEJ401SC  |
| MES-PVE2035AT-250-11.2   | 1-3/4" ACME       | 1" NGT | F. POL | 11.2"          | 250            | –         |
| MES-PVE2035ATSC-250-11.2 | 1-3/4" ACME       | 1" NGT | F. POL | 11.2"          | 250            | MEJ401SC  |
| MES-PVE2035AT-250-11.7   | 1-3/4" ACME       | 1" NGT | F. POL | 11.7"          | 250            | –         |
| MES-PVE2035ATSC-250-11.7 | 1-3/4" ACME       | 1" NGT | F. POL | 11.7"          | 250            | MEJ401SC  |
| MES-PVE2035AT-250-12.0   | 1-3/4" ACME       | 1" NGT | F. POL | 12.0"          | 250            | –         |
| MES-PVE2035ATSC-250-12.0 | 1-3/4" ACME       | 1" NGT | F. POL | 12.0"          | 250            | MEJ401SC  |



# DOT FORKLIFT CYLINDER & ENGINE FUEL VALVES

Intended for vapor or liquid withdrawal service on DOT forklift or engine fuel containers. Two closing flow rates are offered - 1.5 GPM for medium to light duty vehicles and 2.6 GPM for those with greater fuel demands.

NOTE: These valves do not incorporate an integral pressure relief valve and are intended for use in containers that have a separate pressure relief valve to adequately handle the container's capacity. Each of these valves incorporate an excess flow valve at the tanks inlet end to prevent excessive product loss in the event of a downstream fuel line failure. For the excess flow device to perform properly the service valve must be in the full open and back seated position.

## FEATURES

- One piece forged brass body construction
- Dual O-ring packing design
- Easy to repair / replace bonnet assembly
- Universal bonnet assembly
- Industry best fill flow rate
- Factory applied thread sealant
- Replaceable, heavy duty zinc hand wheel featuring a universal design



| Part No.  | Description  | Excess Flow GPM |
|-----------|--|-----------------|
| ME9101P5  | 3/4" MNPT X 3/8" MNPT Forklift Service Valve       | 1.6 GPM         |
| ME9101P5H | 3/4" MNPT X 3/8" MNPT Forklift Service Valve       | 2.6 GPM         |
| ME9101H4  | 3/4" MNPT X 3/8" M. Flare Motor Fuel Service Valve | 1.6 GPM         |
| ME9101H6  | 3/4" MNPT X 3/8" M. Flare Motor Fuel Service Valve | 2.6 GPM         |

This heavy duty designed wrench features a 1/2" drive socket extension for removing and installing motor fuel cylinder valves



# ENGINE FUEL REMOTE FILL VALVE

Specifically designed for remote filling applications where a standard tank type filler valve is not practical. Perfectly suited for motor fuel applications or other hard to reach remote tank applications. This single check fill valve is designed to provide maximum product fill rates along with an automatic shutoff once product flow ceases.

## FEATURES

- Single check design allows maximum product flow rate
- Integral break away feature leaves check valve intact in the event of a vehicle roll away during filling
- Resilient bonded main valve seal
- Rear bulkhead mounting with quarter panel jam nut and lock washer
- Single piece main valve body for maximum strength and durability



| Part No. | Description   | Accessories   |
|----------|---|---------------|
|          |   | Cap & Lanyard |
| ME602-8  | 1-3/4" M. Acme x 1/2" M. Flare Remote Fill Valve w/ Cap & Lanyard | ME602-902     |





# UNDERGROUND TANK CLUSTER MANIFOLD

These multi-purpose valves are designed for use on domestic ASME underground tanks that require a single opening except for a separate liquid withdrawal port.



**MES-PVE2098AT**

## FEATURES

- Epoxy coated ductile iron manifold
- Durable o-ring service valve packing
- Easy to repair / replace bonnet
- Supplied with 30" diptube that can be cut to length
- Standard 1/4" NPT plugged gauge port
- Optional LE vent valve available

| Part No.         | Container Connection | Filling Connection | Service Connection Size | Closing Flow        | Gauge Flange Opening | Pressure Relief Valve Setting | Relief Valve Capacity | Fixed Liquid Level Type |
|------------------|----------------------|--------------------|-------------------------|---------------------|----------------------|-------------------------------|-----------------------|-------------------------|
| MES-PVE2098AT    | 2-1/2" FNPT          | 1-3/4" ACME        | F. POL                  | 4000 CFH @ 100 PSIG | Fits "Junior" Size   | 250 PSIG                      | 1740 SCFM/air         | MEJ400C                 |
| MES-PVE2098ATSC  | 2-1/2" FNPT          | 1-3/4" ACME        | F. POL                  |                     |                      | 250 PSIG                      |                       | MEJ400SC                |
| MES-PVE2098PT*   | 2-1/2" FNPT          | 1-3/4" ACME        | F. POL                  | 4000 CFH @ 100 PSIG | Fits "Junior" Size   | 250 PSIG                      | 1740 SCFM/air         | MEJ400C                 |
| MES-PVE2098PTSC* | 2-1/2" FNPT          | 1-3/4" ACME        | F. POL                  |                     |                      | 250 PSIG                      |                       | MEJ400SC                |

\* Includes ME460 Liquid withdrawal valve packed separately in carton.

# UNDERGROUND TANK CLUSTER VALVE REMOVAL TOOL

Universal design for convenient removal of underground tank cluster valves using a standard 3/4" drive socket wrench.

## FEATURES

- Durable cast steel construction
- Powder coat finish for maximum corrosion protection
- 3/4" drive



**MEP126**

| Part No. | Description                                 |
|----------|---|
| MEP126   | Underground Tank Cluster Valve Removal Tool |



# ENGINE FUEL FILLER VALVES & CONNECTIONS

The CGA 790 quick closing couplings (ME220 Series) are designed to join the carburetion fuel line to the service valve on motor fuel type applications. The Acme threads allow for quick and repeated removal and connection with minimal product loss. The ME220M connects directly to the service valve outlet, while the ME220F Series connects to the motor fuel line. Both couplings have an internal safety check assembly that opens when the two are connected together. Spring force and pressure close both checks when disconnected to provide a leak free seal. The ME220M will fit any refill adapter on the market.

The ME790 Series is designed to provide a fast and reliable connection for filling motor fuel cylinders through the 1-1/4" male Acme service valve connector.

The Moto-Seal Low Emission Connector (ME220FSN) and Filler Valve (ME790SN) are the industry's leader in reducing product emissions without sacrificing flow emitting less than .3 CC during disconnect. The replaceable sealing tip allows the valve to make a bottom face seal when coupled with any mating motor fuel cylinder valve connector.

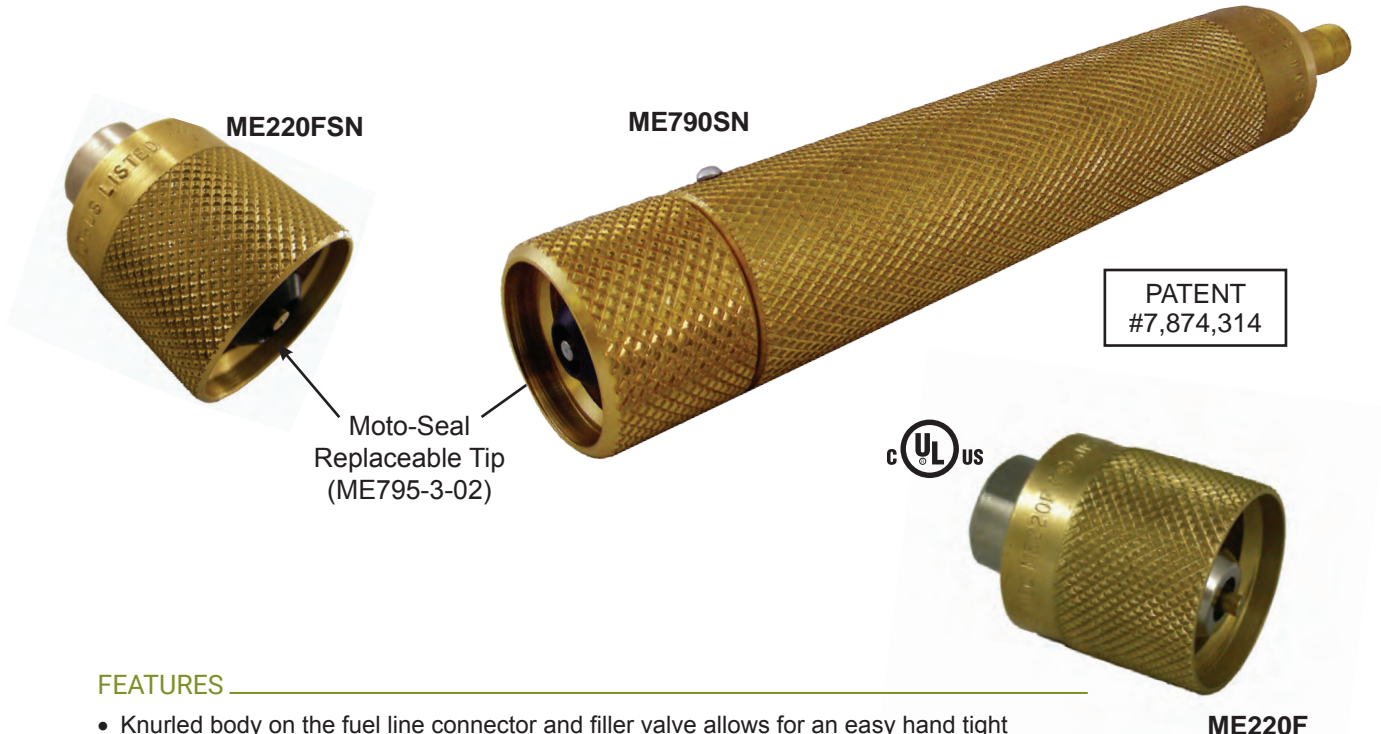

## FEATURES

- Knurled body on the fuel line connector and filler valve allows for an easy hand tight connection even under tank pressure
- Works in conjunction with all mating forklift connectors and filler valves
- ME220F series has a durable riveted valve stem, chrome plated body and wrench flats for easy installation
- ME220M has two seals—an O-ring to minimize product loss during connection and a gasket to seal the two connectors during filling operations
- Moto-Seal connector and filler offers
  - Replaceable tip for maximum service life
  - Positive seal every time with less than **.3 CC** product loss at disconnect
  - 3 layers of security against possible leaks or connection failures when the O-ring and flat gasket are intact on the male connector

| Part No. | Moto-Seal Part No. | Inlet              | Outlet           | Application   | Protective Brass Cap |
|----------|--------------------|--------------------|------------------|---------------|----------------------|
| ME220F   | ME220FSN           | 1-1/4" Female Acme | 1/4" FNPT        | Fuel Line     | —                    |
| ME220M   | —                  | 3/8" FNPT          | 1-1/4" Male Acme | Service Valve | ME220FP              |
| ME790    | ME790SN            | 1-1/4" Female Acme | 1/4" MNPT        | Filler Valve  | —                    |



**ME220M**



# VAPOR SERVICE ENGINE FUEL VALVES & CONNECTORS

These CGA 789 quick closing couplings are designed for use with vapor service motor fuel applications. Incorporates all the same features as the standard and Moto-Seal motor fuel filler valves and connectors. The left hand Acme thread allows service on outdoor motor fuel propane equipment including lawn mowers, etc.

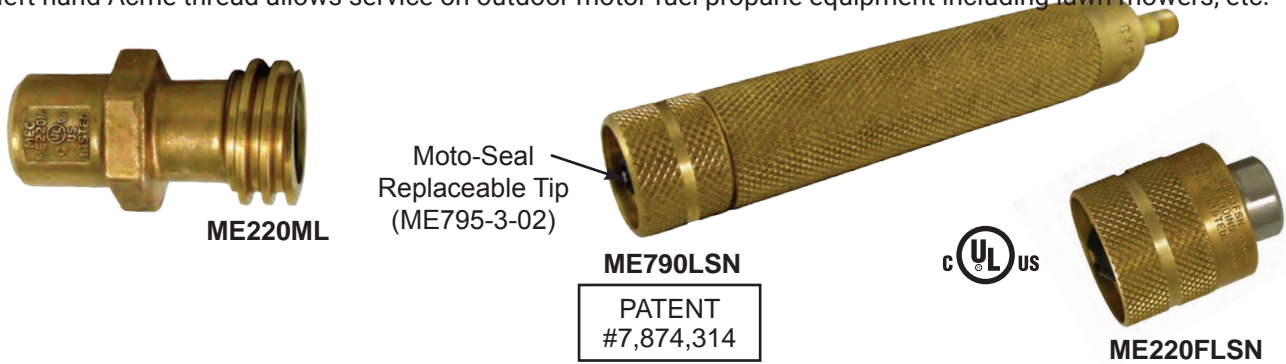

| Part No. | Moto-Seal Part No. | Inlet                        | Outlet                     | Application   | Protective Brass Cap |
|----------|--------------------|------------------------------|----------------------------|---------------|----------------------|
| ME220FL  | ME220FLSN          | 1-1/4" Female Left Hand Acme | 1/4" FNPT                  | Fuel Line     | —                    |
| ME220ML  | —                  | 3/8" FNPT                    | 1-1/4" Male Left Hand Acme | Service Valve | ME220FLP             |
| ME790L   | ME790LSN           | 1-1/4" Female Left Hand Acme | 1/4" MNPT                  | Filler Valve  | —                    |

## ENGINE FUEL BULKHEADS

These bulkheads provide a stationary point for motor fuel lines to pass thru sections of sheet metal.

| Part No. | Connection               | Connection          |
|----------|--------------------------|---------------------|
| MET443   | 3/8" Male Flare          | 1/4" FNPT (2 Ports) |
| MET444   | 3/4"-16 Male / 1/4" FNPT | 1/4" FNPT (2 Ports) |
| MET445   | 3/4"-16 Male / 1/4" FNPT | 1/4" FNPT (3 Ports) |



## CARBURATION FILTER & FITTINGS

The gas/air filter is used to filter foreign materials and/or particles from LP-Gas systems such as motor fuel/carburetion systems. Also designed to be used to filter air supply lines for internal and emergency shutoff valve actuator systems.

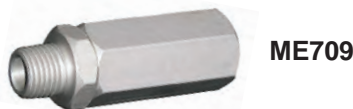

Allows connection of a motor fuel service line from 1-3/4" female Acme vapor outlet.



Enables the installation of a 1/4" MNPT hydrostatic relief valve in a safe, protected area. This two piece carburetion hose fitting fits all stainless steel braided LP-Gas hose with a 5/16" ID. The tank valve side has a 3/8" female flare swivel and zinc plated for maximum corrosion resistance.

| Part No. | Inlet          | Outlet            | Side Port |
|----------|----------------|-------------------|-----------|
| ME709    | 1/4" FNPT      | 1/4" MNPT         | —         |
| ME229-EL | 1-3/4" F. Acme | 1/2" Male Flare   | —         |
| ME8346   | 5/16" ID       | 3/8" Female Flare | 1/4" FNPT |



# QUICK ACTING HOSE END VALVES

## HIGH FLOW LOW EMISSION

These quick acting hose end valves are leading the industry in minimal product loss during disconnect without sacrificing flow. They have instant full-on flow with the added protection of a quick closing, self-locking handle to prevent accidental opening of the valve during handling or storage. They are designed to be used at the end of a filling hose on dispensing systems equipped for filling containers with QCC Type I OPD or F. POL type valves.

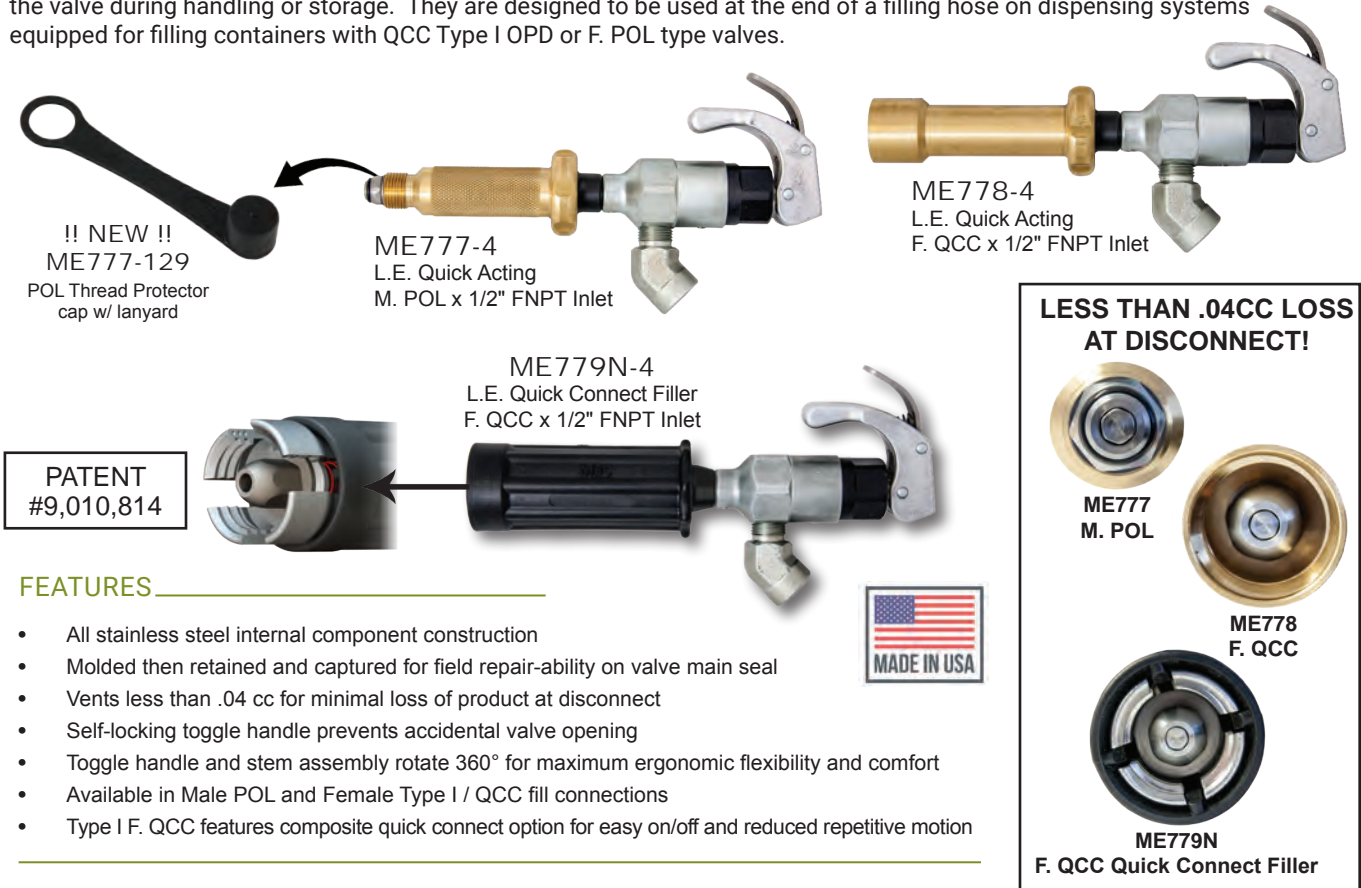

### FEATURES

- All stainless steel internal component construction
- Molded then retained and captured for field repair-ability on valve main seal
- Vents less than .04 cc for minimal loss of product at disconnect
- Self-locking toggle handle prevents accidental valve opening
- Toggle handle and stem assembly rotate 360° for maximum ergonomic flexibility and comfort
- Available in Male POL and Female Type I / QCC fill connections
- Type I F. QCC features composite quick connect option for easy on/off and reduced repetitive motion

| 1/2" High Flow Low Emission Quick Acting Hose End Valves |  |           |        |  |  |               |                 |                        |
|--|--|-----------|--------|--|--|---------------|-----------------|------------------------|
| Part No.   | Description                                      | Inlet     | Outlet | Propane Flow @ 10 PSIG Pressure Differential | Propane Flow @ 30 PSIG Pressure Differential | Handle Style  | Handle Material | Accessories            |
| ME777-4  | Male SN POL Filler Valve with thread cap         | 1/2" FNPT | M. POL | 5.2  | 10.4   | Spin on       | Brass           | ME777-129 thread cap   |
| ME778-4  | Female QCC (Type I) Filler Valve                 | 1/2" FNPT | F. QCC | 5.2  | 10.4   |               | Brass           | —                      |
| ME779-4  | Heavy Duty Female QCC Quick Connect Filler Valve | 1/2" FNPT | F. QCC | 5.2  | 10.4   | Quick Connect | Aluminum        | —                      |
| ME779N-4   | Female QCC Quick Connect Filler Valve            | 1/2" FNPT | F. QCC | 5.2  | 10.4   |               | Composite       | —                      |
| 3/4" High Flow Low Emission Quick Acting Hose End Valves |  |           |        |  |  |               |                 |                        |
| Part No.   | Description                                      | Inlet     | Outlet | Propane Flow @ 10 PSIG Pressure Differential | Propane Flow @ 30 PSIG Pressure Differential | Handle Style  | Handle Material | Accessories            |
| ME777-6  | Male SN POL Filler Valve with thread cap         | 3/4" FNPT | M. POL | 5.2  | 10.4   | Spin on       | Brass           | ME777-129<br>ME850SS-6 |
| ME778-6  | Female QCC (Type I) Filler Valve                 | 3/4" FNPT | F. QCC | 5.2  | 10.4   |               | Brass           | ME850SS-6 Swivel       |
| ME779-6  | Heavy Duty Female QCC Quick Connect Filler Valve | 3/4" FNPT | F. QCC | 5.2  | 10.4   | Quick Connect | Aluminum        |                        |
| ME779N-6   | Female QCC Quick Connect Filler Valve            | 3/4" FNPT | F. QCC | 5.2  | 10.4   |               | Composite       |                        |

# TYPE I (QCC) QUICK FILLER COUPLING

Designed to provide a fast, reliable connection for filling cylinders with Type I (QCC) style valves. The snap on/snap off design is intended to reduce labor and repetitive motion associated with threaded type filler couplings. This easy to operate filler coupling is durable, lightweight and will withstand the harshest working conditions while reducing cylinder valve thread wear.

NOTE: A quick closing shutoff valve must be used with this coupling.

PATENT  
#9,010,814



ME791CJ  
Not Included

## FEATURES

- Durable glass filled nylon handle
- Easy to use **snap on/snap off** action for quick fill operation
- All stainless steel internal components
- Large bore stainless steel stem for increased flow
- Right or left hand operation
- Universal filler connection for all Type I (QCC) service valves

| Part No. | Inlet     | Outlet                            |
|----------|-----------|-----------------------------------|
| ME796    | 1/4" MNPT | 1-5/16" Female Acme Quick Connect |

# TYPE I (QCC) QUICK FILLER COUPLINGS & ADAPTERS

These full size **Type I (QCC) filler couplings** make filling DOT propane cylinders with a QCC connection quick and easy. Just a few turns allows the filler to attach and remove the coupling with minimal effort and loss of product. A longer body allows the filler coupling handle to remain outside the fixed collar of a cylinder. Can be used on a manual, electric or hydraulic system. In a manual system a shutoff valve (ME791C, ME791CJ, ME792C or ME792CJ) should be used with the filler coupling.

WARNING: It is illegal to fill a 40 pound or less DOT propane cylinder that has a standard POL connection.

| Part No. | Inlet     | Outlet              | Handle Style      | Body/Nipple Material  | OAL |
|----------|-----------|---------------------|-------------------|-----------------------|-----|
| ME515    | 1/4" MNPT | 1-5/16" Female Acme | Knurled           | Brass/Brass           | 7"  |
| ME516    | 1/4" MNPT | 1-5/16" Female Acme | Heavy Duty Forged | Brass/Brass           | 6"  |
| ME516S   | 1/4" MNPT | 1-5/16" Female Acme | Heavy Duty Forged | Brass/Stainless Steel | 6"  |



ME516S

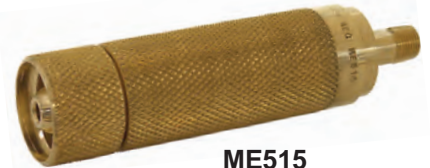

ME515

The Type I (QCC) thread replaces the POL connection on 40 pound or less DOT propane cylinders. Marshall Excelsior has developed numerous adapters to allow quick conversion from Type I (QCC) to different fill applications for retailers who fill both 40 pound or less and larger propane cylinders through the same line. Simply hand tighten the adapter to the Type I (QCC) filler coupling (ME515 or ME516 Series).

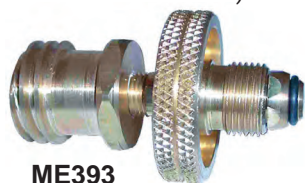

ME393



ME393HD



ME394



ME569

| Part No. | Inlet                        | Outlet             | Handle Style      | Converts Type 1 (QCC) Filler Coupling to |
|----------|------------------------------|--------------------|-------------------|--|
| ME393    | 1-5/16" Male Acme/Female POL | Male Soft Nose POL | Knurled           | POL Filler Coupling                      |
| ME393HD  | 1-5/16" Male Acme/Female POL | Male Soft Nose POL | Heavy Duty Forged | POL Filler Coupling                      |
| ME394    | 1-5/16" Male Acme/Female POL | 1-1/4" Female Acme | Knurled           | Motor Fuel Filler Coupling               |
| ME569    | 1-5/16" Male Acme/Female POL | 1-3/4" Female Acme | Knurled           | Tank Filler Coupling                     |



# POL FILLER COUPLINGS & ADAPTERS

These POL filler couplings make filling DOT propane cylinders with a POL connection quick and easy. A few turns allow the soft nose POL to seal and unseal from the mating POL connection with minimal effort and loss of product. The long body models allow the filler coupling handle to remain outside the fixed collar of the cylinder. Can be used on manual, electric or hydraulic system. In a manual system a shutoff valve (ME791C, ME791CJ, ME792C or ME792CJ) should be used with the filler coupling.



ME390

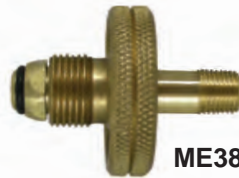

ME388



ME390S

| Part No. | Inlet     | Outlet             | Handle Style      | Body/Nipple Material  | OAL      | Accessories          |
|----------|-----------|--------------------|-------------------|-----------------------|----------|----------------------|
| ME388    | 1/4" MNPT | Male Soft Nose POL | Knurled - 2" Dia. | Bass/Brass            | 2-11/16" | —                    |
| ME390    | 1/4" MNPT | Male Soft Nose POL | Heavy Duty Forged | Brass/Brass           | 6"       | ME777-129 thread cap |
| ME390S   | 1/4" MNPT | Male Soft Nose POL | Heavy Duty Forged | Brass/Stainless Steel | 6"       |                      |

These adapters allow for quick conversion from a POL connection to various filling applications for retailers who fill multiple cylinder types through the same Type I (QCC) connection. Simply hand tighten the adapter to the POL filler connection (ME388 or ME390 Series).

The ME393-2 allows for quick conversion from M. QCC (ME516) or F. POL (ME390) Fill Adapter to a Male Type II / Quick Fill Connector.



ME392



ME394

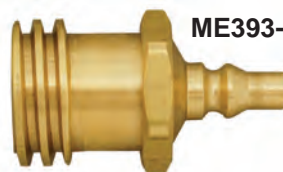

ME393-2



ME568

| Part No. | Inlet                        | Outlet              | Handle Style | Converts POL Filler Coupling to     |
|----------|------------------------------|---------------------|--------------|-------------------------------------|
| ME392    | Female POL                   | 1-5/16" Female Acme | Knurled      | Type I (QCC) Filler Coupling        |
| ME393-2  | Female POL                   | 1-5/16" Male Acme   | —            | Male Type II / Quick Fill Connector |
| ME394    | 1-5/16" Male Acme/Female POL | 1-1/4" Female Acme  | Knurled      | Motor Fuel Filler Coupling          |
| ME568    | Female POL                   | 1-3/4" Female Acme  | Knurled      | Tank Filler Coupling                |

\* Replacement M. QCC/F. POL gasket - Part No. MEW3

# CYLINDER VALVE WRENCHES

Designed to remove or install Type I (QCC)/OPD cylinder valves or POL service valves without damage to the valve base.



MEP121

| Part No. | Thread              | Style             |
|----------|---------------------|-------------------|
| MEP121   | Male POL            | POL               |
| MEP122   | 1-5/16" Female Acme | Type I (QCC)/ OPD |



MEP122



# QUICK ACTING TOGGLE VALVES

Designed for use primarily on cylinder filling operations and industrial applications where quick and precise on/off operation is necessary. Note: This valve flows in one direction. Installing the valve in the opposite direction of the arrow may cause the valve to not close properly and/or pump pressure may open the valve.

## FEATURES

- Positive shutoff
- Corrosion resistant brass construction
- One hand operation
- Optional factory installed vent valve for safe release of captured product



| Part No.    |         | Inlet     | Outlet    | Factory Installed Vent Valve |
|-------------|---------|-----------|-----------|------------------------------|
| Non-Locking | Locking |           |           |                              |
| ME791C      | ME792C  | 1/2" FNPT | 1/4" FNPT | No                           |
| ME791CJ     | ME792CJ | 1/2" FNPT | 1/4" FNPT | Yes                          |
| ME791D      | ME792D  | 1/2" FNPT | 1/2" FNPT | No                           |
| ME791DJ     | ME792DJ | 1/2" FNPT | 1/2" FNPT | Yes                          |

# LIQUID METHANOL INJECTOR

This gravity fed methanol injector provides a fast and efficient method to inject methanol into stationary ASME containers to help prevent condensation from freezing in the propane system.

**WARNING:** Never attempt to refill injector with methanol while connected to a propane container. In order for the tank and methanol injector vapor equalization to occur, no more than 42 ounces of methanol can be contained within the methanol injector.



## FEATURES

- Spark resistant brass connectors and valve
- Durable steel construction body
- Automotive grade powder coat finish for maximum corrosion resistance
- For use with all multi-valve applications or where vapor recovery systems are in place

Maximum Capacity = 42 Ounces  
Maximum Pressure = 250 PSIG

| Part No.  | Vapor Connection   | Description |
|-----------|--------------------|-------------|
| MEP700    | 1-1/4" Female Acme | Assembly    |
| MEP700-01 | --                 | Body Only   |



# COPPER PIGTAILS & HOGTAILS

These pigtail and hogtail assemblies come with two brass connectors brazed onto a heavy wall annealed copper tube with a 250 psig pressure rating. The 1/4" and 3/8" tube have a pull test rating of 500 and 750 pounds respectively. UL LISTED and tested in accordance with UL 569.

Different applications require specific pigtail and hogtail assemblies. Special attention is required when ordering to ensure the proper assembly is purchased for the intended application. Marshall Excelsior recommends every new installation or replacement regulator have a new pigtail installed.

**\*ME1600D Series Dielectric pigtails/ hogtails** are intended to isolate metallic piping from sources of electrical current and to help prevent galvanic corrosion when used on underground containers. The ME1600D dielectric pigtail/ hogtail would typically be installed at the ASME tank directly upstream of the first stage regulator prior to underground piping, isolating the underground metallic piping from electric current.

| Description   | Approx. Length | Part No.     |              |              |              |
|---|----------------|--------------|--------------|--------------|--------------|
|   |                | 1/4" Tube OD |              | 3/8" Tube OD |              |
|   |                | Long Nipple  | Short Nipple | Long Nipple  | Short Nipple |
| Male Hard Nose POL x Male Hard Nose POL, 7/8" Nut         | 6              | —            | ME1664-06    | ME1680L-06   | ME1680-06    |
|   | 12             | ME1662-12*   | ME1664-12*   | ME1680L-12*  | ME1680-12*   |
|   | 20             | ME1662-20*   | ME1664-20*   | ME1680L-20*  | ME1680-20*   |
|   | 30             | ME1662-30    | ME1664-30    | ME1680L-30   | ME1680-30    |
|   | 36             | ME1662-36    | ME1664-36    | ME1680L-36   | ME1680-36    |
|   | 48             | ME1662-48    | ME1664-48    | ME1680L-48   | ME1680-48    |
| Male Hard Nose POL x Male Hard Nose POL, 1-1/8" Nut       | 20             | ME1660-20    | —            | —            | ME1680HD-20  |
|   | 30             | ME1660-30    | —            | —            | —            |
|   | 36             | ME1660-36    | —            | —            | —            |
|   | 48             | ME1660-48    | —            | —            | —            |
| 1/4" Male Inverted Flare x Male Hard Nose POL, 7/8" Nut   | 15             | —            | ME1665-15    | —            | —            |
|   | 20             | ME1663-20    | ME1665-20    | —            | —            |
|   | 30             | ME1663-30    | ME1665-30    | —            | —            |
|   | 36             | ME1663-36    | ME1665-36    | —            | —            |
|   | 48             | ME1663-48    | ME1665-48    | —            | —            |
| 1/4" Male Inverted Flare x Male Hard Nose POL, 1-1/8" Nut | 20             | ME1661-20    | —            | —            | —            |
|   | 30             | ME1661-30    | —            | —            | —            |
|   | 36             | ME1661-36    | —            | —            | —            |
|   | 40             | ME1661-40    | —            | —            | —            |
|   | 48             | ME1661-48    | —            | —            | —            |
| 1/4" MNPT x Male Hard Nose POL, 7/8" Nut                  | 6              | ME1679-06    | ME1669-06    | —            | ME1689-06    |
|   | 12             | ME1679-12*   | ME1669-12*   | ME1689L-12   | ME1689-12    |
|   | 18             | ME1679-18    | ME1669-18*   | —            | —            |
|   | 20             | ME1679-20*   | ME1669-20    | ME1689L-20   | ME1689-20    |
|   | 30             | ME1679-30    | ME1669-30    | ME1689L-30   | ME1689-30    |
|   | 36             | ME1679-36    | ME1669-36    | —            | ME1689-36    |
|   | 48             | ME1679-48    | ME1669-48    | —            | ME1689-48    |
| 1/4" MNPT x Male Hard Nose POL, 1-1/8" Nut                | 20             | ME1679HD-20  | —            | —            | —            |
|   | 48             | ME1679HD-48  | —            | —            | —            |
| 1/2" MNPT x Male Hard Nose POL, 7/8" Nut                  | 12             | —            | —            | ME1684L-12   | ME1684-12    |
|   | 20             | —            | —            | ME1684L-20   | ME1684-20    |



Long Nipple



Short Nipple



1/4" Inverted Flare



1/4" MNPT



Male Hard Nose POL, 7/8" Nut



Dielectric version



\* Note: Dielectric option available. Add "D" after the prefix part number i.e. ME1662D-12





# BENT COPPER PIGTAILS & HOGTAILS



90° Bend



270° Bend Right Hand

| Part No.  | Approximate Length | 1/4" Tube OD Short Nipple | 3/8" Tube OD Short Nipple |                |               |
|---|--------------------|---------------------------|---------------------------|----------------|---------------|
|   |                    | 90°                       | 90°                       | 270° Right     | 360°          |
| Male Hard Nose POL x Male Hard Nose POL, 7/8" Nut | 12                 | —                         | ME1680-12B90              | ME1680-12B270R | ME1680-12B360 |
| 1/4" MNPT x Male Hard Nose POL, 7/8" Nut          | 5                  | ME1669-5B90               | ME1689-5B90               | —              | —             |
|   | 6                  | ME1669-6B90               | ME1689-6B90               | —              | —             |

# THERMOPLASTIC HOSES - 3/8" HOSE ID

Flexible thermoplastic UL and CGA approved hose. These hoses are rated up to 350 psig working pressure with a 400 pound pull test rating. Each hose comes with two ends and fully crimped brass ferrules.

**WARNING:** An excess flow valve will not activate if there is a break or leak downstream of the valve that does not equal or exceed the closing flow of the valve or if the excess flow valve installed exceeds the flow capacity of the system. See the Excess Flow Warning page (PG. 18) for more information regarding the use of excess flow devices.



MNPT



3/8" Female Swivel

| Part No.<br>3/8" Hose ID | Approximate Lengths<br>"X"*                         | Connection               | Connection               |
|--------------------------|---|--------------------------|--------------------------|
| MER610-"X"***            | 24, 30, 36, 48, 60, 120, 144, 240                   | 3/8" MNPT                | 3/8" Female Flare Swivel |
| MER611-"X"***            | 24, 30, 36, 40, 48, 60                              | 1/2" Female Flare Swivel | 3/8" MNPT                |
| MER613-"X"***            | 18, 24, 30, 36, 48, 60, 72, 120, 144, 180, 240, 300 | 3/8" Female Flare Swivel | 3/8" Female Flare Swivel |



\* Replace "X" with the desired hose length i.e. MER610-48

\*\* cULus Listed for lengths up to 60"



# HIGH FLOW THERMOPLASTIC HOSES - 1/4" HOSE ID

| Part No.<br>1/4" Hose ID | Approximate<br>Length<br>"X"*                     | Connection   | Connection                                      |
|--------------------------|---|--|---|
| MER409-"X"               | 15, 20, 24, 36, 60                                | Male Hard Nose POL, 7/8" Nut                               | Male Hard Nose POL, 7/8" Nut                    |
| MER428-"X"               | 60, 120   | Female QCC, Type I Connection                              | Male QCC, Type I Connection with Female POL     |
| MER412-"X"**             | 20  | .9 GPM Excess Flow Male Hard Nose POL, 7/8" Nut            | .9 GPM Excess Flow Male Hard Nose POL, 7/8" Nut |
| MER425-"X"**             | 12, 15, 18, 20, 24, 30, 36, 48, 60                | Female QCC, Type I Connection                              | 1/4" Male Inverted Flare                        |
| MER427-"X"               | 20  | Female QCC, Type I Connection                              | 3/8" Female Flare Swivel                        |
| MER403-"X"**             | 12, 15, 18, 20, 24, 30, 36, 48, 60, 72, 120, 240  | Male Hard Nose POL, 7/8" Nut                               | 1/4" Male Inverted Flare                        |
| MER401-"X"**             | 12, 15, 18, 20, 24, 30, 36, 48, 60                | .9 GPM Excess Flow Male POL, 7/8" Nut                      | 1/4" Male Inverted Flare                        |
| MER423-"X"               | 15, 20, 24, 30, 36                                | .9 GPM Excess Flow Male Soft Nose POL, Plastic Handwheel   | 1/4" Male Inverted Flare                        |
| MER404-"X"               | 15, 18, 20, 24, 36                                | #60 Orifice Hole Male Soft Nose POL, Plastic Handwheel     | 1/4" Male Inverted Flare                        |
| MER404AR-"X"             | 18, 24, 36  | #60 Orifice Hole Male Soft Nose POL, Brass Round Handwheel | 1/4" Male Inverted Flare                        |
| MER406AR-"X"             | 12, 24, 36, 48, 60                                | Male Soft Nose POL, Brass Round Handwheel                  | 1/4" MNPT                                       |
| MER405-"X"               | 12, 15, 18, 20, 24, 30, 36, 48, 60                | .9 GPM Excess Flow Male POL, 7/8" Nut                      | 1/4" MNPT                                       |
| MER414-"X"               | 10, 14, 120                                       | 1/4" MNPT  | 1/4" MNPT                                       |
| MER422-"X"               | 6, 240  | 1/4" Female Flare Swivel                                   | 1/4" MNPT                                       |
| MER434-"X"               | 36, 50  | 3/8" Female Flare Swivel                                   | 1/4" MNPT                                       |
| MER429-"X"               | 60,120  | Red Female QCC, Type I Connection                          | Male QCC, Type I Connection with Female POL     |
| MER426-"X"               | 12, 15, 20, 24, 36, 60                            | Female QCC, Type I Connection                              | 1/4" MNPT                                       |
| MER410-"X"**             | 10, 12, 20, 24, 30, 36, 48, 60, 72, 120, 144, 180 | 3/8" MNPT  | 3/8" Female Flare Swivel                        |
| MER413-"X"**             | 24, 36, 48, 60, 72, 96, 120, 144, 180             | 3/8" Female Flare Swivel                                   | 3/8" Female Flare Swivel                        |
| MER408-"X"               | 12, 36, 60, 72, 144, 288                          | 9/16"-18 Female Left Hand Swivel                           | 9/16"-18 Female Left Hand Swivel                |
| MER407-"X"               | 24, 36, 48, 60, 72, 120, 144                      | #60 Orifice Hole Male Soft Nose POL, Plastic Handwheel     | 1"-20 Male Swivel                               |
| MER421-"X"               | 24, 48, 60, 72, 144                               | 1"-20 Female Swivel  | 1"-20 Male Swivel                               |

\* Replace "X" with the desired hose length i.e. MER409-24

\*\* cULus Listed for lengths up to 60"

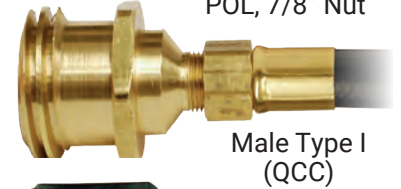

# HIGH FLOW THERMOPLASTIC HOSES - 1/4" HOSE ID

## for HIGH CAPACITY REGULATORS

The High Flow Series Hoses are specifically designed to meet the high demands of today's motorhomes, trailers and on demand water heaters.

Our new High Flow Type I 400,000 BTU (red nut) hoses are designed for those applications that require more than 200,000 BTU's. The new High Flow hoses are designed with both excess flow and thermal link safety features, just like the green nut Type I connector.

### FEATURES

- 400,000 BTU capacity
- Excess flow safety shut-off
- RVIA and NFPA 1192 Compliant
- Brass ferrules
- 1/4" ID High pressure thermoplastic hose
- 1/4" Inv. Flare and 1/4" MPT connection offered
- 100% Leak tested
- 350 PSIG working pressure



| Part No.    | Approximate Length "X" * | Connection                    | Connection               | Available Packaged** |
|-------------|--------------------------|-------------------------------|--------------------------|----------------------|
| MER425H-"X" | 12, 15, 18, 24           | Female QCC, Type I Connection | 1/4" Male Inverted Flare | Yes                  |
| MER426H-"X" | 15, 20                   | Female QCC, Type I Connection | 1/4" MNPT                | Yes                  |

\* Replace "X" with the desired hose length i.e. MER425H-15

# STAINLESS STEEL BRAIDED HOSES

MEC Stainless Steel braided hoses are for connecting propane cylinders to the propane regulator. The Stainless Steel braid provides added protection to the hose along with the safety features of thermal protection in case of fire and excess flow protection in case of broken gas line. Female QCC, Type I connection x 1/4" inverted male flare.

NOTE: MEC green Type I Nut for use on RV application ONLY.  
(200,000 BTU/H)  
MEC red Type I NUT approved for RV applications.  
(400,000 BTU/H)

### FEATURES

- Capacity: Standard - 200,000 BTU/H  
High Flow - 400,000 BTU/H
- Excess Flow Safety Shut-Off
- RVIA and NFPA 1192 Compliant
- Brass Ferrules
- 1/4" Inv. Flare and 1/4" MPT connection offered
- 100% Leak Tested
- 350 PSIG Working Pressure
- UL Recognized Components



| Part No.      | Approximate Length "X" * | Description                          |
|---------------|--------------------------|--------------------------------------|
| MER425SS-"X"  | 15, 24, 36               | Standard QCC w/ Braided SS Hose      |
| MER425HSS-"X" | 15,24                    | High Capacity QCC w/ Braided SS Hose |

\* Replace "X" with the desired hose length i.e. MER425SS-15



# FLOW-LONGER / FLOW-LONGER PLUS HOSE KITS

The Flow-Longer Propane Kits are designed to connect small, portable appliances, normally fueled by disposable LP-Gas cylinders, to the existing LP-Gas fuel supply of a recreational vehicle, cottage, backyard patio, etc. without interrupting the supply of regulated fuel to the system. Flow-Longer eliminates the need to purchase an extra LP-Gas cylinder or several small, disposable type cylinders.

## MER470 FLOW-LONGER PROPANE KIT INCLUDES

- Brass tee connection (ME415) .9 GPM excess flow male hard nose POL x female POL x 1"-20 male
- 12 foot hose (MER421-144) 1"-20 male x 1"-20 female

## MER471 FLOW-LONGER PLUS PROPANE KIT INCLUDES

- Brass elbow connection (ME423) .9 GPM excess flow male hard nose POL x 1-5/16" male Acme/female POL with quick closing poppet x 1"-20 female
- 12 foot hose (MER421-144) 1"-20 male x 1"-20 female



MER470



MER471

# STAY-LONGER / STAY-LONGER PLUS HOSE KITS

The Stay-Longer Propane Kits are designed to give you new flexibility on how you use your LP-Gas. You can stay longer by hooking up auxiliary LP-Gas cylinders, or you can tap into the RV's LP-Gas system to fuel portable high-pressure appliances.

## MER472 STAY-LONGER PROPANE KIT INCLUDES

- Brass tee connection (ME420) .9 GPM excess flow male hard nose POL x female POL x 1"-20 male x 1/4" female inverted flare
- 5 foot hose (MER401-60) .9 GPM excess flow male POL x 1/4" male inverted flare

## MER473 STAY-LONGER PLUS PROPANE KIT INCLUDES

- Brass tee connection (ME420) .9 GPM excess flow male hard nose POL x female POL x 1"-20 male x 1/4" female inverted flare
- 5 foot hose (MER401-60) .9 GPM excess flow male hard nose POL x 1/4" male inverted flare
- 12 foot hose (MER421-144) 1"-20 male x 1"-20 female



MER472

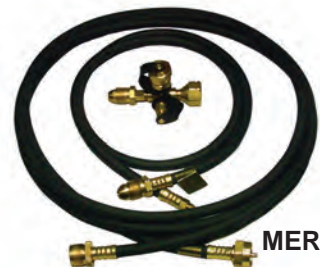

MER473

**All kits include installation instructions and a convenient reusable box for storage.**

NOTE: The tee fitting must be installed between the vapor withdrawal valve on your LP-Gas container and the pressure regulator. This properly places the tee fitting in the high pressure portion of the LP-Gas system. Gas connections to the tee fitting are not designed for movement or rotation after installation. Flexing, twisting, or vibration should be avoided.

WARNING: An excess flow valve will not activate if there is a break or leak downstream of the valve that does not equal or exceed the closing flow of the valve or if the excess flow valve installed exceeds the flow capacity of the system. See the Excess Flow Warning page for more information regarding the use of excess flow devices.

# TYPE I (QCC) / OPD VALVE CAP

Designed to protect the 1-5/16" male Acme threads on Type I (QCC) or OPD type cylinder valves. Using a cap will reduce the likelihood of inadvertent damage to the valve's threads, shutoff mechanisms and sealing surfaces during storage or refurbishment.

ME392P installed on 20 LB cylinder



ME392P

| Part No. |             | Fits              |
|----------|-------------|-------------------|
| Brass    | Black Vinyl |                   |
| ME392P   | ME952-07    | 1-5/16" Male Acme |



ME952-07

# TYPE I (QCC) CONNECTORS

The Type I (QCC) connectors (ME517, ME518 and ME519 Series) are designed with a built-in excess flow feature and a positive shutoff that will not allow gas to flow until the connector is fully engaged. In case of a fire the built-in thermal protection on the QCC connector melts allowing the nipple to disengage from the tank connection and stop the flow of propane. These QCC connectors also provide a positive back check seal at disconnect to eliminate the propane in the hose from being released into the atmosphere.

To connect a Type I (QCC) connector to a cylinder, close the cylinder valve and the control valves to all connected appliances. Hand tighten the QCC onto the cylinder and slowly open the cylinder valve. If the valve is opened too quickly, the excess flow device will be activated closing the flow of propane to the appliance. If the excess flow device is activated, close appliance control valves and wait 60 seconds to allow pressure in the line to equalize. Additional equalization time may be needed depending on the length of the hose. Turn on appliances by following the manufacturer's suggested lighting procedures.

NOTE: The Type I (QCC) thread replaces the POL connection on 40 pound or less DOT propane cylinders.



ME517



ME518-25H

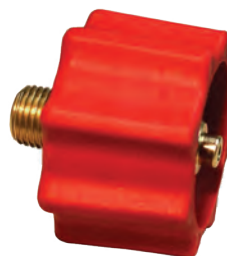

ME519



ME517EV

| Part No.  |                |                |                  | Inlet               | Flow Capacity             | Handwheel Color | Thermal Protection |
|-----------|----------------|----------------|------------------|---------------------|---------------------------|-----------------|--------------------|
| Outlet    |                |                |                  |                     |                           |                 |                    |
| 1/4" MNPT | 1/4" Hose Barb | 3/8" Hose Barb | 8.5 mm Hose Barb |                     |                           |                 |                    |
| ME517     | ME517-25H      | ME517-38H      | -                | 1-5/16" Female Acme | 50 SCFH Air/100,000 BTUH  | Black           | Yes                |
| ME518     | ME518-25H      | ME518-38H      | ME518-8.5H       | 1-5/16" Female Acme | 100 SCFH Air/200,000 BTUH | Green           | Yes                |
| ME519     | ME519-25H      | ME519-38H      | -                | 1-5/16" Female Acme | 200 SCFH Air/400,000 BTUH | Red             | Yes                |

U.S. PATENT #6,895,952



| Part No. | Inlet               | Flow Capacity | Handwheel Color | Thermal Protection | Description         |
|----------|---------------------|---------------|-----------------|--------------------|---------------------|
| ME517EV  | 1-5/16" Female Acme | Full Flow     | Black           | Yes                | Evacuation Coupling |

WARNING: An excess flow valve will not activate if there is a break or leak downstream of the valve that does not equal or exceed the closing flow of the valve or if the excess flow valve installed exceeds the flow capacity of the system. See the Excess Flow Warning page for more information regarding the use of excess flow devices.



# GAS BOX™ CONVENIENCE OUTLET

Designed to eliminate the need for a 20 LB cylinder or modifications generally needed to plumb an outdoor appliance to a DOT or ASME stationary tank. The Gas Box™ utilizes the standard LP-Gas outdoor appliance regulator and connector. Simply hard plumb a gas line from the first stage regulator into the Gas Box™. Then thread the standard Type I (QCC) or POL connector onto the Gas Box™, turn on the shutoff valve and enjoy continuous LP-Gas flow. Both models provide full capacity operation at 10 psig or higher inlet pressures for all outdoor appliances without modifications.

The Gas Box™ is an easy way to guarantee increased propane sales. It eliminates the need for 20 pound cylinders, allowing the customer to purchase any appliance without modifications.

## FEATURES

- Universal Type I (QCC) / female POL outlet connection
- Primary shutoff valve for each outlet connection
- Secondary safety shutoff poppet at each outlet for zero discharge at disconnect
- For use with 10-250 psig inlet pressure
- Universal mounting hardware
- Hinged cover with latching mechanism
- Weather resistant high density polyethylene case

PATENT  
#9,249,974

| Part No.        |                 |                 | Inlet     | Outlet                       | No. of Outlets | Accessories  |
|-----------------|-----------------|-----------------|-----------|------------------------------|----------------|--|
| Black           | Gray            | Ivory           |           |                              |                |  |
| <b>ME951BLK</b> | <b>ME951GRY</b> | <b>ME951IVY</b> | 1/2" FNPT | 1-5/16" Male Acme/Female POL | Single         | MER428-60 = 60" Extension Hose<br>MER428-120 = 120" Extension Hose<br>(Male QCC/Female POL x Female QCC)                   |
| <b>ME952BLK</b> | <b>ME952GRY</b> | <b>ME952IVY</b> | 1/2" FNPT | 1-5/16" Male Acme/Female POL | Dual           | MER429-60 = 60" Extension Hose<br>MER429-120 = 120" Extension Hose<br>(Male QCC/Female POL x Red Female QCC-400,000 BTU/H) |

## FLOW RATE / CAPACITY SPECIFICATIONS

### Model ME951 – Single outlet \*

- 750,000 BTU/HR – 100 psig inlet pressure / Outlet regulated @ 9.5 – 13 in. W.C. (11" nom.)
- 450,000 BTU/HR – 10 psig inlet pressure / Outlet regulated @ 9.5 – 13 in. W.C. (11" nom.)

### Model ME952 – Dual outlet \*

One outlet closed

- 750,000 BTU/HR – 100 psig inlet pressure / Outlet regulated @ 9.5 – 13 in. W.C. (11" nom.)
- 450,000 BTU/HR – 10 psig inlet pressure / Outlet regulated @ 9.5 – 13 in. W.C. (11" nom.)

Both outlets open (at each outlet)

- 750,000 BTU/HR – 100 psig inlet pressure / Outlet regulated @ 9.5 – 13 in. W.C. (11" nom.)
- 325,000 BTU/HR – 10 psig inlet pressure / Outlet regulated @ 9.5 – 13 in. W.C. (11" nom.)

\*These are average capacities and may change slightly due to pressure drop depending on individual installation conditions and length of gas supply runs for the service line. The BTU capacities shown will be further reduced by the flow limiting device in the female type I connection provided with the appliance being attached to the gas box.



ME951BLK



ME952GRY



ME952IVY



MER428



# TYPE I (QCC) INSTALLATION ADAPTERS

Designed to provide a safe permanent outlet when installed into the household LP-Gas system. This permanent outlet eliminates the need for smaller containers when operating outdoor LP-Gas equipment. It is recommended that a shutoff valve be installed upstream from the adapter inlet to facilitate future servicing.

NOTE: To use the female POL on the ME393 series, simply remove the internal gasket. The gasket must be in place to use the Type I (QCC) connection.

## FEATURES

- Can be used with both Type I (QCC) and male POL connections
- ME398 and ME399 include an internal shutoff valve which provides a leak free means for outdoor equipment to be safely connected and disconnected without shutting down the entire system



| Part No.   | Inlet              | Outlet                       | Shutoff Device       |
|------------|--------------------|------------------------------|----------------------|
| ME393-1    | 1/4" FNPT          | 1-5/16" Male Acme/Female POL | —                    |
| ME393EX    | 1/4" FNPT          | 1-5/16" Male Acme/Female POL | .9 GPM Excess Flow*  |
| ME393EX1.8 | 1/4" FNPT          | 1-5/16" Male Acme/Female POL | 1.8 GPM Excess Flow* |
| ME398      | Male Soft Nose POL | 1-5/16" Male Acme/Female POL | Quick Closing        |
| ME399      | 1/4" MNPT          | 1-5/16" Male Acme/Female POL | Quick Closing        |

\* An excess flow device does not provide a 100% shutoff, a small amount of propane may leak if disconnected

WARNING: An excess flow valve will not activate if there is a break or leak downstream of the valve that does not equal or exceed the closing flow of the valve or if the excess flow valve installed exceeds the flow capacity of the system. See the Excess Flow Warning page for more information regarding the use of excess flow devices.



# LOW PRESSURE QUICK DISCONNECT COUPLINGS

Designed to provide convenient quick connect and disconnect for low pressure gas appliances with 100% positive gas shut off at female coupler end of the connection. Maximum operating pressure 1/2 PSIG.

## FEATURES

- Convenient wrench flats for securing connection points
- One piece coupler body
- Approved for all low pressure gas applications
- Durable all brass construction
- For indoor & outdoor applications



| Part No.*  | Description   |
|------------|---|
| ME-GMC4    | Quick Disconnect Assy - 1/4" FNPT x 1/4" MNPT Nipple              |
| ME-GMCL-4  | 1/4" Quick Disconnect Ball Valve Coupler - 1/4" FNPT w/ Dust Cap  |
| ME-GMC4-02 | 1/4" Quick Disconnect Nipple x 1/4" MNPT Adapter                  |
| ME-GMC4-03 | 1/4" Quick Disconnect Nipple x 1/4" Hose Barb Adapter             |
| ME-GMC6    | 3/8" Quick Disconnect Assy - 3/8" FNPT Coupler x 3/8" FNPT Nipple |
| ME-RVSDC-4 | Replacement Dust Cap - 1/4" QD Coupler w/ Lanyard                 |



# CYLINDER COLLARS

These steel propane cylinder collars are designed to protect the valve installed on a cylinder. An automotive grade powder coat finish provides maximum corrosion resistance.

**WARNING:** It is illegal to fill a tank without a protective collar. Without a protective collar serious damage can occur to the cylinder valve which can lead to catastrophic events such as the tank becoming a dangerous projectile, an explosion and/or fire causing property damage, or personal injury or death.

| Part No.  | Size   | *Multi-Valve |
|-----------|--------|--------------|
| ME312-5MV | 3-1/8" | Yes          |
| ME350     | 3-1/2" | No           |
| ME350MV   | 3-1/2" | Yes          |

\* Multi-Valve style features cut-out in thread to provide clearance for assembly over container valve





# MALE POL X 1/4" MNPT

| Part No.           |                              |                    | Connection | Male POL Description                  |
|--------------------|------------------------------|--------------------|------------|---------------------------------------|
| Male Hard Nose POL | Male Hard Nose POL 90° Angle | Male Soft Nose POL |            |                                       |
| ME318              | ME345                        | ME1629             | 1/4" MNPT  | 7/8" Nut                              |
| ME322              | —                            | —                  | 1/4" MNPT  | 7/8" Nut, 3-1/2" OAL                  |
| —                  | —                            | ME1654             | 1/4" MNPT  | Plastic Handwheel                     |
| —                  | —                            | ME1654AH           | 1/4" MNPT  | Hex Handwheel                         |
| —                  | —                            | ME1654AR           | 1/4" MNPT  | Round Handwheel                       |
| ME319              | ME348                        | —                  | 1/4" MNPT  | 1-1/8" Nut                            |
| ME1690<br>ME1690P  | —                            | ME1641             | 1/4" MNPT  | .9 GPM Excess Flow, 7/8" Nut          |
| —                  | —                            | ME1653             | 1/4" MNPT  | .9 GPM Excess Flow, Plastic Handwheel |
| —                  | —                            | ME1653AH           | 1/4" MNPT  | .9 GPM Excess Flow, Hex Handwheel     |
| —                  | —                            | ME1653AR           | 1/4" MNPT  | .9 GPM Excess Flow, Round Handwheel   |
| ME1692             | —                            | —                  | 1/4" MNPT  | .9 GPM Excess Flow, 1-1/8" Nut        |
| ME1690-EX18        | —                            | ME1641EX18         | 1/4" MNPT  | 1.8 GPM Excess Flow, 7/8" Nut         |
| —                  | —                            | ME1638             | 1/4" MNPT  | #60 Orifice Hole, 7/8" Nut            |

Male Hard Nose POL

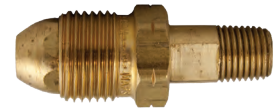

Male Soft Nose POL



Plastic Handwheel



ME345



# MALE POL X HOSE BARBS

| Part No.           |                    | Hose I.D. | Male POL Description                  |
|--------------------|--------------------|-----------|---------------------------------------|
| Male Hard Nose POL | Male Soft Nose POL |           |                                       |
| ME5930             | ME1656-78N         | 1/4"      | 7/8" Nut                              |
| ME5931-78N         | ME5931-78SN        | 3/8"      | 7/8" Nut                              |
| ME5930-118N        | ME1656-118N        | 1/4"      | 1-1/8" Nut                            |
| ME5931             | ME5931-SN          | 3/8"      | 1-1/8" Nut                            |
| —                  | ME1656             | 1/4"      | Plastic Handwheel                     |
| —                  | ME1656AH           | 1/4"      | Hex Handwheel                         |
| —                  | ME1656AR           | 1/4"      | Round Handwheel                       |
| ME1683             | ME1655-78N         | 1/4"      | .9 GPM Excess Flow, 7/8" Nut          |
| ME5931EX-78N       | ME5931SNEX-78N     | 3/8"      | .9 GPM Excess Flow, 7/8" Nut          |
| ME1684             | —                  | 1/4"      | .9 GPM Excess Flow, 1-1/8" Nut        |
| —                  | ME1655             | 1/4"      | .9 GPM Excess Flow, Plastic Handwheel |
| —                  | ME1655AH           | 1/4"      | .9 GPM Excess Flow, Hex Handwheel     |
| —                  | ME1655AR           | 1/4"      | .9 GPM Excess Flow, Round Handwheel   |
| —                  | ME1655EX18-78N     | 1/4"      | 1.8 GPM Excess Flow, 7/8" Nut         |
| —                  | ME1657             | 1/4"      | #60 Orifice Hole, 7/8" Nut            |

Hex Handwheel



Round Handwheel



**WARNING:** An excess flow valve will not activate if there is a break or leak downstream of the valve that does not equal or exceed the closing flow of the valve or if the excess flow valve installed exceeds the flow capacity of the system. See the Excess Flow Warning page for more information regarding the use of excess flow devices.



# SINGLE PIECE POL ADAPTERS

| POL x MNPT |                |             |      |
|------------|----------------|-------------|------|
| Part No.   | POL Connection | Excess Flow | MNPT |
| ME284      | Female         | —           | 1/4" |
| ME285      | Female         | —           | 3/8" |
| ME286      | Female         | —           | 1/2" |
| ME287      | Female         | —           | 3/4" |
| ME352      | Male Hard Nose | —           | 3/8" |
| ME354      | Male Hard Nose | —           | 1/2" |
| ME354EX9   | Male Hard Nose | .9 GPM      | 1/2" |
| ME354EX18  | Male Hard Nose | 1.8 GPM     | 1/2" |

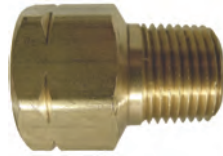

ME285



ME353EX18



ME353

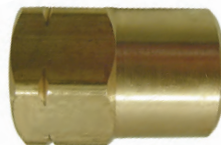

ME303

| POL x Male Flare |                |             |            |
|------------------|----------------|-------------|------------|
| Part No.         | POL Connection | Excess Flow | Male Flare |
| ME353            | Male Hard Nose | —           | 3/8"       |
| ME353-SN         | Male Soft Nose | —           | 3/8"       |
| ME353EX9         | Male Hard Nose | .9 GPM      | 3/8"       |
| ME353EX18        | Male Hard Nose | 1.8 GPM     | 3/8"       |
| ME355            | Male Hard Nose | —           | 1/2"       |
| ME355-SN         | Male Soft Nose | —           | 1/2"       |
| ME355EX18        | Male Hard Nose | 1.8 GPM     | 1/2"       |
| ME356            | Male Hard Nose | —           | 5/8"       |
| ME356-SN         | Male Soft Nose | —           | 5/8"       |
| ME356EX9         | Male Hard Nose | .9 GPM      | 5/8"       |
| ME356EX18        | Male Hard Nose | 1.8 GPM     | 5/8"       |

| POL x FNPT |                |      |
|------------|----------------|------|
| Part No.   | POL Connection | FNPT |
| ME301      | Female         | 1/4" |
| ME302      | Female         | 3/8" |
| ME303      | Female         | 1/2" |
| ME304      | Female         | 3/4" |
| ME351      | Male Hard Nose | 1/4" |
| ME357      | Male Hard Nose | 1/2" |

| POL x POL |                |                |
|-----------|----------------|----------------|
| Part No.  | POL Connection | POL Connection |
| ME305     | Female         | Female         |



WARNING: An excess flow valve will not activate if there is a break or leak downstream of the valve that does not equal or exceed the closing flow of the valve or if the excess flow valve installed exceeds the flow capacity of the system. See the Excess Flow Warning page for more information regarding the use of excess flow devices.

# POL CAP & PLUGS

| Part No.  |                 |           | Style                   |
|-----------|-----------------|-----------|-------------------------|
| Brass     |                 | Plastic   |                         |
| Body Only | Body With Chain | Body Only |                         |
| ME1691    | ME1691-1        | ME970P    | Male Hard Nose POL Plug |
| ME1699    | —               | —         | Female POL Cap          |



ME1691



ME1699



ME970P



# SAFE-T-LOCKS

Designed to prevent tampering, product theft and/or accidental discharge of product. This product is perfect for any size tank valve with a POL connection or 1-3/4" Acme connection or gas plumbing, such as a riser.

To install, securely screw the plug or cap to the valving or plumbing using the appropriate wrench. Snap locking mechanism into place over plug or cap. Locking mechanism will cover the installation hex or knurl and swivel freely until key is inserted and the lock is removed.

## FEATURES

- All brass body construction for maximum durability
- Locking mechanism and key features durable chrome plating
- Locking mechanism swivels 360° when installed to prevent tampering or removal
- Locking mechanism cannot be removed without key
- Universal key for all sizes and styles

| Part No. | Thread             | Packaging               | Additional Keys |
|----------|--------------------|-------------------------|-----------------|
| ME530    | Male Soft Nose POL | 12 Plugs & Locks, 1 Key | ME530-03        |
| ME530PL  | Male Soft Nose POL | 12 Caps & Locks, 1 Key  | ME530-03        |



(padlock not included)

# POL THREAD CLEAN OUT TOOL

Designed for use with any female POL thread or valve inlet opening. Allows operator to safely remove debris and other foreign material from female .880-14 NGO left hand threads (female POL) without damaging threads. Simply thread clean out tool into female POL threads using handwheel until the tool reaches the final thread. Reverse and remove tool carefully. Reverse tool and use attached 7/8" diameter bottle brush to perform final clean out operation. Blow out any remaining debris by using a compressed air line.

## FEATURES

- Constructed from hardened tool steel and plated for maximum product life
- Four clearance flutes to allow debris to be channeled away from threads
- Convenient 7/8" diameter wire brush for final clean out



**WARNING:** The POL thread clean out tool is strictly intended for use as a cleaning device and in no way should be used as a gauge to determine the usability of the thread. (Always refer to NFPA 58 and follow the appropriate guidelines prior to installing LP-Gas lines)



# TEE CHECK MANIFOLDS

These manifolds are designed to connect two cylinders. The check keeps the two tanks equalized and allows each tank to be changed without disrupting the flow of propane to appliances or dispensing large amounts of LP-Gas into the atmosphere from the other tank. When changing out a tank, simply close the tank valve and disconnect. The check will automatically move to the closed tank valve side to seal off the inlet of that tank allowing minimal LP-Gas discharge into the atmosphere. Primary uses are for mobile homes, single appliances, recreational vehicles or summer cottages.

The manual changeover works the same as the check except it requires the consumer to manually close the manifold valve on the side of the tank being changed over.

| Part No. | Inlet                      | Inlet                      | Outlet             | Nut Size |
|----------|----------------------------|----------------------------|--------------------|----------|
| ME1701A  | Female POL                 | Female POL                 | Male Hard Nose POL | 7/8"     |
| ME1702A  | Female POL                 | Female POL                 | Male Hard Nose POL | 1-1/8"   |
| ME1705A  | Female POL                 | Female POL                 | 1/4" MNPT          | —        |
| ME1700A  | 1/4" Female Inverted Flare | 1/4" Female Inverted Flare | 1/4" MNPT          | —        |
| MEP456A* | 1/4" Female Inverted Flare | 1/4" Female Inverted Flare | 1/4" MNPT          | —        |

\* Manual Change Over

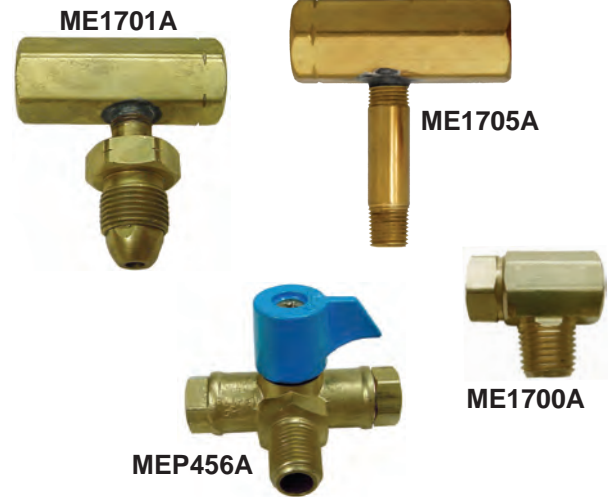

# MULTIPLE CYLINDER TEE BLOCK MANIFOLDS

These manifolds are designed to connect multiple cylinders to automatic changeover regulators. These manifolds have no check and are primarily for systems requiring more than one cylinder to be in operation at a time. The appropriate pigtail must be used to connect the manifold inlet to the service cylinder valve.

| Part No.     | Inlet                      | Inlet                      | Outlet                                | Nut Size |
|--------------|----------------------------|----------------------------|---------------------------------------|----------|
| ME1701       | Female POL                 | Female POL                 | 1/4" FNPT                             | —        |
| ME1701B      | Female POL                 | Female POL                 | Male Hard Nose POL                    | 7/8"     |
| ME1702B      | Female POL                 | Female POL                 | Male Hard Nose POL                    | 1-1/8"   |
| ME1701B-SN   | Female POL                 | Female POL                 | Male Soft Nose POL                    | 7/8"     |
| ME1701X      | Female POL                 | Female POL                 | Male .9 GPM Excess Flow Hard Nose POL | 7/8"     |
| ME1701B-X-SN | Female POL                 | Female POL                 | Male .9 GPM Excess Flow Soft Nose POL | 7/8"     |
| ME1704B      | Female POL                 | Female POL                 | Female POL                            | 1-1/8"   |
| ME1700B      | 1/4" Female Inverted Flare | 1/4" Female Inverted Flare | 1/4" MNPT                             | —        |
| ME-T9-444    | 1/4" FNPT                  | 1/4" FNPT                  | 1/4" MNPT                             | —        |



**WARNING:** An excess flow valve will not activate if there is a break or leak downstream of the valve that does not equal or exceed the closing flow of the valve or if the excess flow valve installed exceeds the flow capacity of the system. See the Excess Flow Warning page for more information regarding the use of excess flow devices.



# CAMPING TEES

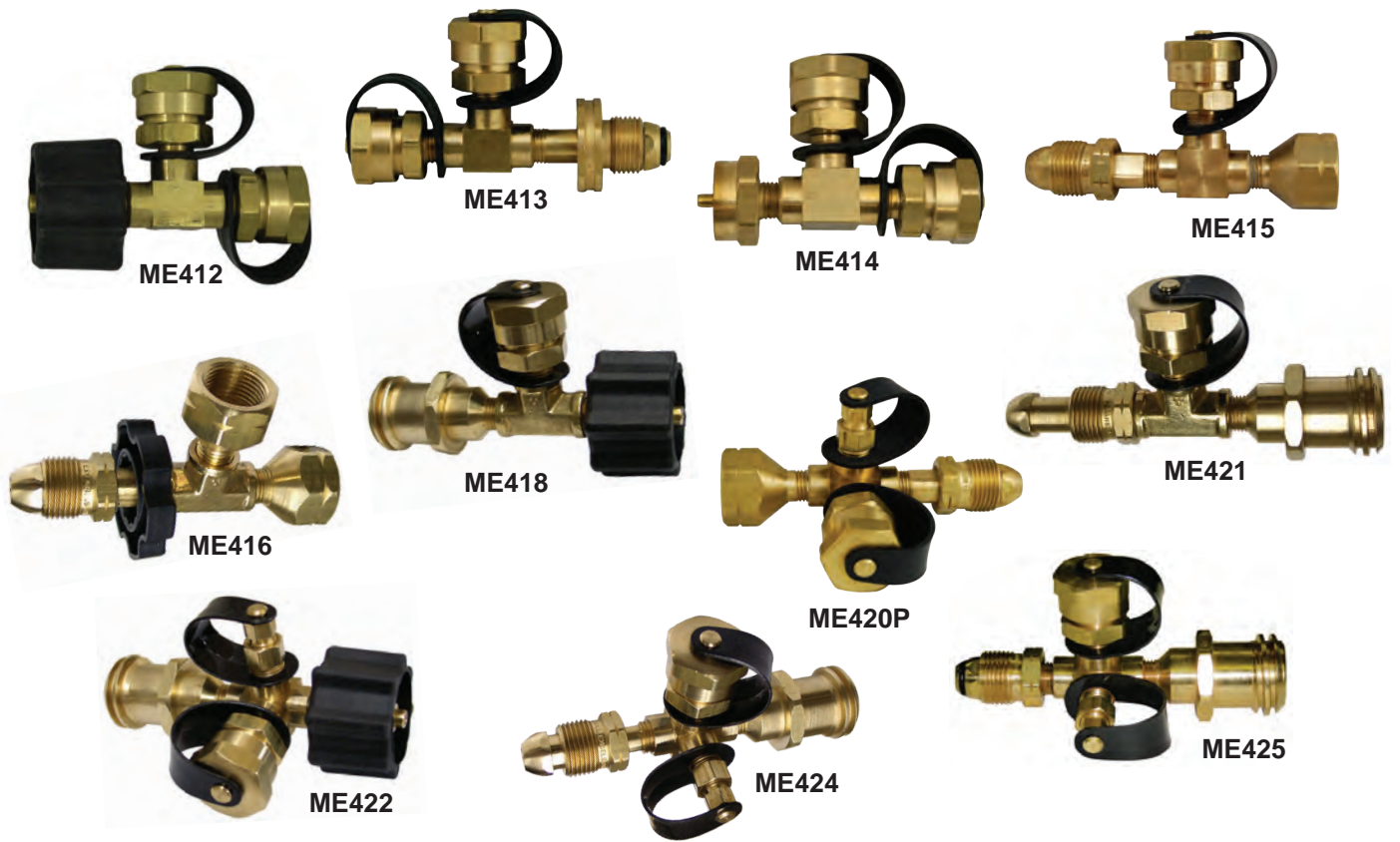

| Part No. | Inlet  | Auxiliary Inlet                       | Outlet   | Outlet     |
|----------|--|---------------------------------------|--|------------|
| ME412    | 1-5/16" Female Acme  | —                                     | 1"-20 Male   | 1"-20 Male |
| ME413    | #60 Male Soft Nose POL with Round Brass Handwheel            | —                                     | 1"-20 Male   | 1"-20 Male |
| ME414    | 1"-20 Female   | —                                     | 1"-20 Male   | 1"-20 Male |
| ME415    | .9 GPM Excess Flow Male Hard Nose POL                        | —                                     | Female POL   | 1"-20 Male |
| ME416    | .9 GPM Excess Flow Male Hard Nose POL with Plastic Handwheel | —                                     | Female POL   | Female POL |
| ME418    | 1-5/16" Female Acme  | —                                     | 1-5/16" Male Acme/Female POL with Quick Closing Poppet | 1"-20 Male |
| ME420    | .9 GPM Excess Flow Male Hard Nose POL                        | 1/4" Female Inverted Flare with Check | Female POL   | 1"-20 Male |
| ME421    | .9 GPM Excess Flow Male Hard Nose POL                        | —                                     | 1-5/16" Male Acme/Female POL with Quick Closing Poppet | 1"-20 Male |
| ME422    | 1-5/16" Female Acme  | 1/4" Female Inverted Flare            | 1-5/16" Male Acme/Female POL with Quick Closing Poppet | 1"-20 Male |
| ME424    | .9 GPM Excess Flow Male Hard Nose POL                        | 1/4" Female Inverted Flare with Check | 1-5/16" Male Acme/Female POL with Quick Closing Poppet | 1"-20 Male |
| ME425    | .9 GPM Excess Flow Male Soft Nose POL                        | 1/4" Female Inverted Flare with Check | 1-5/16" Male Acme/Female POL with Quick Closing Poppet | 1"-20 Male |

WARNING: An excess flow valve will not activate if there is a break or leak downstream of the valve that does not equal or exceed the closing flow of the valve or if the excess flow valve installed exceeds the flow capacity of the system. See the Excess Flow Warning page for more information regarding the use of excess flow devices.



# CAMPING ELBOWS & ASSEMBLIES



ME423



ME474



ME481



ME477



ME475AR



ME475



ME475B



ME497



ME497AR

| Part No. | Inlet  | Outlet  | Outlet     |
|----------|--|---|------------|
| ME423    | .9 GPM Excess Flow Male Hard Nose POL                        | 1-5/16" Male Acme/Female POL with Quick Closing Pop-pet | 1"-20 Male |
| ME474    | 1-5/6" Female Acme   | 1"-20 Male  | —          |
| ME475    | #60 Male Soft Nose POL with Plastic Handwheel                | 1"-20 Male  | —          |
| ME475AR  | #60 Male Soft Nose POL with Round Brass Handwheel            | 1"-20 Male  | —          |
| ME475B   | #60 Male Soft Nose POL                                       | 1"-20 Male  | —          |
| ME477    | .9 GPM Excess Flow Male Hard Nose POL with Plastic Handwheel | 1"-20 Male  | —          |
| ME481    | 1"-20 Female   | 1-5/16" Male Acme/Female POL with Quick Closing Pop-pet | —          |
| ME497    | Male Soft Nose POL with Plastic Handwheel                    | 1"-20 Male  | —          |
| ME497AR  | Male Soft Nose POL with Round Brass Handwheel                | 1"-20 Male  | —          |

WARNING: An excess flow valve will not activate if there is a break or leak downstream of the valve that does not equal or exceed the closing flow of the valve or if the excess flow valve installed exceeds the flow capacity of the system. See the Excess Flow Warning page for more information regarding the use of excess flow devices.

# CAMPING FITTINGS



**ME417**



**ME483**



**ME484**



**ME485**

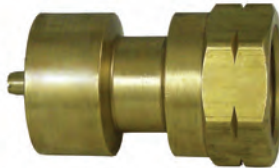

**ME487**



**ME488**



**ME491**



**ME492**



**ME493**

with check and o-ring

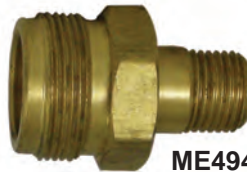

**ME494**

no check



**ME496**

| Part No.     | Inlet                       | Outlet                                     |
|--------------|-----------------------------|--|
| <b>ME417</b> | 1/4" MNPT                   | 1"-20 Male with Check & O-ring             |
| <b>ME483</b> | 1"-20 Female Cap with Strap | —  |
| <b>ME484</b> | 1"-20 Female                | 1/4" Hose Barb                             |
| <b>ME485</b> | 1"-20 Female                | 1/4" FNPT                                  |
| <b>ME487</b> | 1"-20 Female                | Female POL                                 |
| <b>ME488</b> | 1"-20 Female                | 1/4" MNPT                                  |
| <b>ME491</b> | 3/8" Male Flare             | 1"-20 Male with Check & O-ring             |
| <b>ME492</b> | 1/4" FNPT                   | 1"-20 Male - No Check                      |
| <b>ME493</b> | 9/16"-18 Male Left Hand     | 1"-20 Male with Check & O-ring             |
| <b>ME494</b> | 9/16"-18 Male Left Hand     | 1"-20 Male - No Check                      |
| <b>ME496</b> | 1/4" Hose Barb              | 1"-20 Male Swivel with Valve Stem & O-ring |



# LAST CHANCE ADAPTERS

Designed to provide a quick way to change from a 20 pound cylinder to a 1 pound disposable cylinder. Can be used to connect a small 1 pound disposable cylinder to a gas grill or other appliance.

NOTE: To use the female POL on the ME480 series, simply remove the internal gasket. The gasket must be in place to use the Type I (QCC) connection (reference pg. 183).



ME480EX



ME480



ME481P

| Part No.   | Inlet        | Outlet                       | Description         |
|------------|--------------|------------------------------|---------------------|
| ME480      | 1"-20 Female | 1-5/16" Male Acme/Female POL | Full Flow           |
| ME480EX    | 1"-20 Female | 1-5/16" Male Acme/Female POL | .9 GPM Excess Flow  |
| ME480EX1.8 | 1"-20 Female | 1-5/16" Male Acme/Female POL | 1.8 GPM Excess Flow |
| ME481      | 1"-20 Female | 1-5/16" Male Acme/Female POL | Shutoff Poppet      |

NOTE: An excess flow device does not provide a 100% shutoff, a small amount of propane may leak if disconnected

WARNING: An excess flow valve will not activate if there is a break or leak downstream of the valve that does not equal or exceed the closing flow of the valve or if the excess flow valve installed exceeds the flow capacity of the system. See the Excess Flow Warning page for more information regarding the use of excess flow devices.

# DIELECTRIC UNIONS

The ME690 series dielectric unions are intended to isolate metallic piping from sources of electrical current and to help prevent galvanic corrosion. The ME690 dielectric union would typically be installed at the ASME tank directly downstream of the first stage regulator but prior to underground piping and/or at the inlet of the second stage regulator above ground at the dwelling there by protecting the underground metallic piping from corrosion and electrical current.

## FEATURES

- Heavy duty brass construction
- Convenient male NPT x male SAE flare connection to minimize potential piping leak points and extra fittings
- Compact size for tight spaces
- Wide wrench flats for easy installation
- Will not conduct an electrical charge from one side of the union to the other



ME690-4-8

| Part No.   | Description                                  | OAL    |
|------------|--|--------|
| ME690-4-6  | Dielectric Union 1/2" MNPT x 3/8" Male Flare | 3-3/8" |
| ME690-6-6  | Dielectric Union 3/4" MNPT x 3/8" Male Flare | 3-1/2" |
| ME690-4-8  | Dielectric Union 1/2" MNPT x 1/2" Male Flare | 3-1/2" |
| ME690-6-8  | Dielectric Union 3/4" MNPT x 1/2" Male Flare | 3-5/8" |
| ME690-4-10 | Dielectric Union 1/2" MNPT x 5/8" Male Flare | 3-5/8" |
| ME690-6-10 | Dielectric Union 3/4" MNPT x 5/8" Male Flare | 3-3/4" |





# FLARE FITTINGS

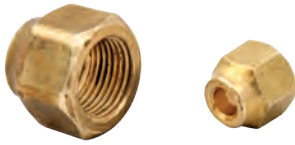

| Short Forged Nuts |                |
|-------------------|----------------|
| Part No.          | O.D. Tube Size |
| ME-NS4-4          | 1/4"           |
| ME-NS4-6          | 3/8"           |
| ME-NS4-8          | 1/2"           |
| ME-NS4-10         | 5/8"           |
| ME-NS4-12         | 3/4"           |



| Reducing Forged Nuts |                |
|----------------------|----------------|
| Part No.             | O.D. Tube Size |
| ME-NS4-6-4           | 3/8" x 1/4"    |
| ME-NS4-8-4           | 1/2" x 1/4"    |
| ME-NS4-8-6           | 1/2" x 3/8"    |
| ME-NS4-10-8          | 5/8" x 1/2"    |



| Forged Swivel Nuts |                |
|--------------------|----------------|
| Part No.           | O.D. Tube Size |
| ME-US4-6           | 3/8"           |
| ME-US4-8           | 1/2"           |
| ME-US4-10          | 5/8"           |

| Reducing Forged Swivel Nuts |                |
|-----------------------------|----------------|
| Part No.                    | O.D. Tube Size |
| ME-US4-8-6                  | 1/2" x 3/8"    |
| ME-US4-10-8                 | 5/8" x 1/2"    |



| Full Unions |                |
|-------------|----------------|
| Part No.    | O.D. Tube Size |
| MEF42-4-4   | 1/4"           |
| MEF42-6-6   | 3/8"           |
| MEF42-8-8   | 1/2"           |
| MEF42-10-10 | 5/8"           |



| Reducing Unions |                |
|-----------------|----------------|
| Part No.        | O.D. Tube Size |
| MEF42-8-6       | 1/2" x 3/8"    |
| MEF42-10-6      | 5/8" x 3/8"    |
| MEF42-10-8      | 5/8" x 1/2"    |



| Female Connectors |                |      |
|-------------------|----------------|------|
| Part No.          | O.D. Tube Size | FNPT |
| MEF46-4-4         | 1/4"           | 1/4" |
| MEF46-6-4         | 3/8"           | 1/4" |
| MEF46-6-6         | 3/8"           | 3/8" |
| MEF46-6-8         | 3/8"           | 1/2" |
| MEF46-6-12        | 3/8"           | 3/4" |
| MEF46-8-6         | 1/2"           | 3/8" |
| MEF46-8-8         | 1/2"           | 1/2" |
| MEF46-8-12        | 1/2"           | 3/4" |
| MEF46-10-6        | 5/8"           | 3/8" |
| MEF46-10-8        | 5/8"           | 1/2" |
| MEF46-10-12       | 5/8"           | 3/4" |



| Male Connectors |                |      |
|-----------------|----------------|------|
| Part No.        | O.D. Tube Size | MNPT |
| MEF48-4-2       | 1/4"           | 1/8" |
| MEF48-4-4       | 1/4"           | 1/4" |
| MEF48-6-2       | 3/8"           | 1/8" |
| MEF48-6-4       | 3/8"           | 1/4" |
| MEF48-6-6       | 3/8"           | 3/8" |
| MEF48-6-8       | 3/8"           | 1/2" |
| MEF48-6-12      | 3/8"           | 3/4" |
| MEF48-8-4       | 1/2"           | 1/4" |
| MEF48-8-6       | 1/2"           | 3/8" |
| MEF48-8-8       | 1/2"           | 1/2" |
| MEF48-8-12      | 1/2"           | 3/4" |
| MEF48-10-6      | 5/8"           | 3/8" |
| MEF48-10-8      | 5/8"           | 1/2" |
| MEF48-10-12     | 5/8"           | 3/4" |
| MEF48-12-8      | 3/4"           | 1/2" |
| MEF48-12-12     | 3/4"           | 3/4" |



| Forged Female Elbows |                |      |
|----------------------|----------------|------|
| Part No.             | O.D. Tube Size | FNPT |
| MEF54-6-6            | 3/8"           | 3/8" |
| MEF54-6-8            | 3/8"           | 1/2" |
| MEF54-6-12           | 3/8"           | 3/4" |
| MEF54-8-6            | 1/2"           | 3/8" |
| MEF54-8-8            | 1/2"           | 1/2" |
| MEF54-8-12           | 1/2"           | 3/4" |
| MEF54-10-8           | 5/8"           | 1/2" |
| MEF54-10-12          | 5/8"           | 3/4" |



# FLARE FITTINGS & PIPE THREAD ADAPTERS



| Forged Male Elbows |                |      |
|--------------------|----------------|------|
| Part No.           | O.D. Tube Size | MNPT |
| MEF49-4-6          | 1/4"           | 3/8" |
| MEF49-6-4          | 3/8"           | 1/4" |
| MEF49-6-6          | 3/8"           | 3/8" |
| MEF49-6-8          | 3/8"           | 1/2" |
| MEF49-6-12         | 3/8"           | 3/4" |
| MEF49-8-4          | 1/2"           | 1/4" |
| MEF49-8-6          | 1/2"           | 3/8" |
| MEF49-8-8          | 1/2"           | 1/2" |
| MEF49-8-12         | 1/2"           | 3/4" |
| MEF49-10-8         | 5/8"           | 1/2" |
| MEF49-10-12        | 5/8"           | 3/4" |



| 2 Way Forged Elbows |                |
|---------------------|----------------|
| Part No.            | O.D. Tube Size |
| MEF55-6             | 3/8"           |
| MEF55-8             | 1/2"           |
| MEF55-10            | 5/8"           |
| MEF55-12            | 3/4"           |



| Male Tee       |                |
|----------------|----------------|
| Part No.       | O.D. Tube Size |
| MEF44-6-6-6    | 3/8"           |
| MEF44-8-8-8    | 1/2"           |
| MEF44-10-10-10 | 5/8"           |

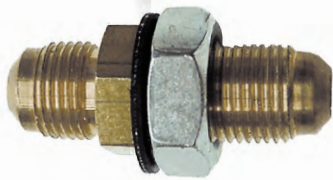

| RV Bulkhead |                               |
|-------------|-------------------------------|
| Part No.    | Description                   |
| MESTF33     | 3/8" M. Flare x 3/8" M. Flare |

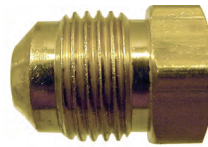

| Flare Plugs |                |
|-------------|----------------|
| Part No.    | O.D. Tube Size |
| MEP2-4      | 1/4"           |
| MEP2-6      | 3/8"           |
| MEP2-8      | 1/2"           |
| MEP2-12     | 3/4"           |

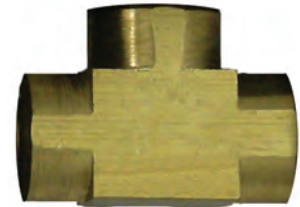

| Female Tee |      |
|------------|------|
| Part No.   | FNPT |
| ME415-01   | 1/4" |



| Flare Caps |                |
|------------|----------------|
| Part No.   | O.D. Tube Size |
| ME1695-4   | 1/4"           |
| ME1695-6   | 3/8"           |
| ME1695-8   | 1/2"           |
| ME1695-12  | 3/4"           |



| Pipe Threads Unions |      |      |
|---------------------|------|------|
| Part No.            | MNPT | MNPT |
| MEF216-2            | 1/8" | 1/8" |
| MEF216-4            | 1/4" | 1/4" |
| MEF216-6            | 3/8" | 3/8" |
| MEF216-6-8          | 3/8" | 1/2" |
| MEF216-8            | 1/2" | 1/2" |
| MEF216-8-4          | 1/2" | 1/4" |
| MEF216-12           | 3/4" | 3/4" |

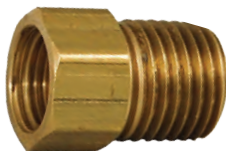

| Inverted Flare Adapter |                                |                                    |
|------------------------|--------------------------------|------------------------------------|
| Part No.               | Description                    | Accessory                          |
| ME2132                 | 1/4" F. Inv. Flare x 1/4" MNPT | ME2131<br>1/4" Inverted Flare Plug |



| Tube Nut |                |
|----------|----------------|
| Part No. | O.D. Tube Size |
| MEF41-6  | 3/8"           |



# CGA 555 FITTINGS

CGA 555 adapters are standard cylinder valve outlet connections for liquid butane or propane withdrawal. They are designed to withstand pressures up to 3,000 psig.

| Part No. | Inlet          | Outlet                  |
|----------|----------------|-------------------------|
| ME306    | Female CGA 555 | 1/4" MNPT               |
| ME307    | Female CGA 555 | 9/16"-18 Male Left Hand |
| ME308    | Female CGA 555 | Female POL              |



ME306



ME308

| Part No. | Cap with Chain |
|----------|----------------|
| ME309-1  | CGA 555        |



ME309-1

# HIGH PRESSURE GAS CONNECTIONS

| Part No.           |                |          | Hose I.D. | Threads                   |
|--------------------|----------------|----------|-----------|---------------------------|
| Hose Barb Assembly | Hose Barb Only | Nut Only |           |                           |
| ME23C              | ME23C-1        | ME23C-2  | 1/4"      | 9/16"-18 Female Left Hand |
| ME23E              | ME23E-1        | ME23C-2  | 3/8"      | 9/16"-18 Female Left Hand |



ME23C

| Part No.           |                    | Connection              | POL Description                        |
|--------------------|--------------------|-------------------------|--|
| Male Hard Nose POL | Male Soft Nose POL |                         |  |
| ME1650             | ME1650SN           | 9/16"-18 Male Left Hand | 7/8" Nut                               |
| ME1651             | -                  | 9/16"-18 Male Left Hand | 1-1/8" Nut                             |
| ME1689             | ME1645-78N         | 9/16"-18 Male Left Hand | .9 GPM Excess Flow, 7/8" Nut           |
| -                  | ME1645             | 9/16"-18 Male Left Hand | .9 GPM Excess Flow, Plastic Hand-wheel |
| ME1687             | -                  | 9/16"-18 Male Left Hand | .9 GPM Excess Flow, 1-1/8" Nut         |
| ME1689-EX18        | -                  | 9/16"-18 Male Left Hand | 1.8 GPM Excess Flow, 7/8" Nut          |

Soft Nose POL



Hard Nose POL



| Outlet Bushings |                       |                         |
|-----------------|-----------------------|-------------------------|
| Part No.        | Male Left Hand Thread | Thread                  |
| ME24C           | 9/16"-18              | 1/4" MNPT               |
| ME24E           | 9/16"-18              | 3/8" MNPT               |
| ME24F           | 9/16"-18              | 1/2" MNPT               |
| ME26C           | 9/16"-18              | 9/16"-18 Male Left Hand |



ME24C

**WARNING:** An excess flow valve will not activate if there is a break or leak downstream of the valve that does not equal or exceed the closing flow of the valve or if the excess flow valve installed exceeds the flow capacity of the system. See the Excess Flow Warning page for more information regarding the use of excess flow devices.



# HOSE BARBS

| Part No.               |                                 |                    |                                   | Hose I.D. | Threads                  |
|------------------------|---------------------------------|--------------------|-----------------------------------|-----------|--------------------------|
| Brass                  |                                 | Steel <sup>1</sup> |                                   |           |                          |
| Four Barb Low Pressure | Seven Barb High Pressure        | Four Barb          | Four Barb with 3/64" Orifice Hole |           |                          |
| ME4631                 | —                               | —                  | —                                 | 1/4"      | 1/8" FNPT                |
| ME4632                 | ME5632                          | —                  | —                                 | 1/4"      | 1/4" FNPT                |
| ME4633                 | ME5633                          | —                  | —                                 | 1/4"      | 3/8" FNPT                |
| ME4652                 | —                               | —                  | —                                 | 3/8"      | 1/4" FNPT                |
| ME4653                 | ME5653                          | —                  | —                                 | 3/8"      | 3/8" FNPT                |
| ME4654                 | —                               | —                  | —                                 | 3/8"      | 1/2" FNPT                |
| ME4231                 | ME5231                          | —                  | —                                 | 1/4"      | 1/8" MNPT                |
| ME4232                 | ME5232                          | —                  | —                                 | 1/4"      | 1/4" MNPT                |
| ME4233                 | ME5233                          | —                  | —                                 | 1/4"      | 3/8" MNPT                |
| —                      | —                               | A6132              | A6133                             | 3/8"      | 1/8" MNPT                |
| ME4252                 | —                               | A1132              | A1133                             | 3/8"      | 1/4" MNPT                |
| ME4253                 | ME5253                          | —                  | —                                 | 3/8"      | 3/8" MNPT                |
| ME4254                 | —                               | —                  | —                                 | 3/8"      | 1/2" MNPT                |
| —                      | —                               | A6138              | A6139                             | 1/2"      | 1/8" MNPT                |
| —                      | —                               | A1138              | A1139                             | 1/2"      | 1/4" MNPT                |
| ME4273                 | —                               | —                  | —                                 | 1/2"      | 3/8" MNPT                |
| ME4274                 | ME5274                          | —                  | —                                 | 1/2"      | 1/2" MNPT                |
| ME4293                 | —                               | —                  | —                                 | 5/8"      | 3/8" MNPT                |
| ME4835                 | ME5835                          | —                  | —                                 | 1/4"      | 3/8" Male Flare          |
| ME4855                 | —                               | —                  | —                                 | 3/8"      | 3/8" Male Flare          |
| ME4857                 | —                               | —                  | —                                 | 3/8"      | 1/2" Male Flare          |
| —                      | ME5133                          | —                  | —                                 | 1/4"      | 1/4" Male Inverted Flare |
| ME4333                 | —                               | —                  | —                                 | 1/4"      | 1/4" Female Flare Swivel |
| ME4335 <sup>2</sup>    | ME5334 <sup>5,6</sup><br>ME5335 | —                  | —                                 | 1/4"      | 3/8" Female Flare Swivel |
| ME4355 <sup>3</sup>    | ME5336 <sup>6</sup><br>ME5355   | —                  | —                                 | 3/8"      | 3/8" Female Flare Swivel |
| ME4357                 | ME5357                          | —                  | —                                 | 3/8"      | 1/2" Female Flare Swivel |
| ME4377 <sup>4</sup>    | ME5377                          | —                  | —                                 | 1/2"      | 1/2" Female Flare Swivel |

(1) Rated for LP-Gas & NH<sub>3</sub> (4) ME4377-1 (barb only); ME4377-2 (nut only)  
 (2) ME4335-1 (barb only); ME4335-2 (nut only) (5) ME5334-1 (barb only)  
 (3) ME4355-1 (barb only); ME4335-2 (nut only) (6) Forged Nut



# HOSE FERRULES & HOSE MENDERS



ME7327



ME27C



ME27E

| Part No. | I.D.  | OAL |
|----------|-------|-----|
| ME7323   | .525" | 1"  |
| ME7324   | .531" | 1"  |
| ME7325   | .562" | 1"  |
| ME7326   | .593" | 1"  |
| ME7327   | .625" | 1"  |

| Part No. | I.D.  | OAL |
|----------|-------|-----|
| ME7329   | .687" | 1"  |
| ME7330   | .718" | 1"  |
| ME7331   | .750" | 1"  |
| ME7332   | .781" | 1"  |
| ME7333   | .812" | 1"  |

| Part No. | Hose I.D.   |
|----------|-------------|
| ME27C    | 1/4" x 1/4" |
| ME27E    | 3/8" x 3/8" |

## LOW TEMPERATURE LEAK DETECTOR

General purpose leak detector for all pressurized gases. Designed to detect joint leaks within 5 seconds of proper application at temperatures down to -40° F.

| Part No. | Size      | Description    |
|----------|-----------|----------------|
| ME-LD02  | 2 Ounces  | Spray Bottle   |
| ME-LD1   | 8 Ounces  | Cap and Dauber |
| ME-LD16  | 16 Ounces | Cap and Brush  |
| ME-LD2   | 1 Gallon  | Container      |



ME-LD02



ME-LD16



ME-LD2

## HIGH PRESSURE TEST BLOCKS

Designed to test high pressure lines downstream of the container valve for system leaks. The optional bleeder valve enables the line pressure to be adjusted to the desired test pressure.



MEJ600



MEJ601

| Part No.    | Inlet              | Outlet     | PSIG  | Factory Installed Vent Valve |
|-------------|--------------------|------------|-------|------------------------------|
| MEJ600      | Male Hard Nose POL | Female POL | 0-300 | No                           |
| MEJ601      | Male Hard Nose POL | Female POL | 0-300 | Yes                          |
| MEJ601-WOG* | Male Hard Nose POL | Female POL | —     | Yes                          |

\* Without gauge



# LOW PRESSURE TEST KIT & ADAPTERS

These kits are designed to check for gas leaks by verifying the line pressure of an appliance. Each kit includes a case, gauge, and rubber hose with a bell on the end.

## FEATURES

- Capacity 0 - 35" water column
- Adjustable gauge models can be reset to zero with provided screwdriver
- Three foot rubber hose with bell



ME50-2



ME50P-5



ME60P-2



ME50P-2



ME1332

| Kit with Case | Part No.          |                              |                              | Adjustable Gauge | Manometer Adapter                    |
|---------------|-------------------|------------------------------|------------------------------|------------------|--------------------------------------|
|               | Gauge & Hose Only | Gauge & Hose Barb Connection | Gauge & 1/4" MNPT Connection |                  |                                      |
| ME60P-2       | ME60P-5           | —                            | ME60-2                       | Yes              | ME1328 (3/8" OD)<br>ME1331 (1/2" OD) |
| ME50P-2       | ME50P-5           | ME50-2                       | ME50-2-01                    | No               | ME1332 (5/8" OD)                     |

# SERVICEMAN'S FRIEND

The serviceman's friend (METL051 & METL052) eliminates the hassle of carrying numerous bushing and fittings to each job site. It has three threads on one end with a hose barb and an 1/8" MNPT on the other end. A hose can easily be attached to either end and can be connected to a manometer or other flow meters to check line pressure on an appliance.

| Part No. | Connection                               | Connection                           |
|----------|--|--------------------------------------|
| METL051  | 5/16"-32 Male / 1/8" MNPT / 1/2"-24 Male | Standard test hose fitting/1/8" MNPT |
| METL052  | 5/16"-32 Male / 1/8" MNPT / 1/4" MNPT    | Standard test hose fitting/1/8" MNPT |



METL051

# LOW PRESSURE TEST BLOCK



MEJ610/30

Designed to test low pressure lines for system leaks. The factory installed check valve allows the line to be pressurized and adjusted to the desired test pressure.

| Part No.   | Inlet     | PSIG  |
|------------|-----------|-------|
| MEJ610/15  | 3/4" FNPT | 0-15  |
| MEJ610/30  | 3/4" FNPT | 0-30  |
| MEJ610/60  | 3/4" FNPT | 0-60  |
| MEJ610/100 | 3/4" FNPT | 0-100 |



# K&A SAFETY TEST EQUIPMENT

## LEAK CHECK AND REGULATOR TESTING KITS

Intended for bobtail drivers who are trained to conduct out of gas leak check tests. The ME-SQTG Series gauge assembly give the service technician what is needed to test pressure regulators for flow set point and lock-up pressure in addition to leak check testing.

NOTE: Model number suffix A or B designates which type of pressure tap valve will be used. The A designates the type VA valve (Schrader) and B designates the type VB valve (1/4" flare).



ME-QTG16B

**ME-QTG127A and ME-QTG128B Dual Gauge Kits** are used for leak check tests at intermediate pressure using the 30 PSI gauge and also leak check tests at tank pressure using the 300 PSI gauge and the high pressure test block supplied with the kit. The hose assembly connection to the system pressure tap valve incorporates a quick disconnect fitting to either pressure gauge. Kit includes six pressure tap valves, either type A or type B depending on which kit is specified.

**ME-QTG16A and ME-QTG16B Dual Gauge Kits** are used for leak check test at intermediate pressure using the 30 PSI gauge and testing first stage regulator. The 35" water column gauge is used for testing low pressure second stage regulator set point and lock up press.

**ME-SQTG4A and ME-SQTG4B Four Gauge Kits** include a 30 PSI gauge, a 300 PSI gauge, a 5 PSI gauge, a 35" water column gauge, and a high pressure test block plus six pressure tap valves either type A or type B depending on which kit is specified. The hose quick disconnect allows for attachment of any one of the gauges. A leak check pressure tap valve can be anywhere in the system with the proper gauge attached for leak check testing. This kit also allows the service technician to test all pressure regulators, including the first stage, using the 30 PSI gauge, a 2 PSI regulator using the 5 PSI gauge, and low pressure 11' W.C. regulators or appliance manifold pressure using the 35" WC gauge.



ME-SQTG-4B

| Part No.   | Description  |
|------------|--|
| ME-QTG127A | Dual Gauge Leak Check Kit - 30 and 300 PSI Gauges with Type A Valves (6)           |
| ME-QTG128B | Dual Gauge Leak Check Kit - 30 and 300 PSI Gauges with Type B Valves (6)           |
| ME-QTG16A  | Dual Gauge Leak Check Kit - 30 PSI and 35" WC Gauges with Type A Valves (6)        |
| ME-QTG16B  | Dual Gauge Leak Check Kit - 30 PSI and 35" WC Gauges with Type B Valves (6)        |
| ME-SQTG-4A | Four Gauge Kits (Includes 5, 30, 300 PSI and 35" WC Gauges) with Type A Valves (6) |
| ME-SQTG-4B | Four Gauge Kits (Includes 5, 30, 300 PSI and 35" WC Gauges) with Type B Valves (6) |

## REPLACEMENT GAUGES AND ADAPTERS



ME-GA30N



ME-AD-BA

| Adapters                |  |  |
|-------------------------|--|--|
| Part No.                | Description  |  |
| ME-AD-AB                | Adapter - Connects Type A hose swivel connector to type B pressure tap valve |  |
| ME-AD-BA                | Adapter - Connects Type B hose swivel connector to type A pressure tap valve |  |
| Gauges                  |  |  |
| w/ 1/4" MNPT Connection | w/ Quick Disconnect Nipple   | Description                                    |
| MEJ501                  | ME-GA30N   | 0-30 PSI Bourdon tube gauge - 1/4" MNPT Inlet  |
| MEJ600-02               | ME-GA300N  | 0-300 PSI Bourdon tube gauge - 1/4" MNPT Inlet |
| ME50ECO-2               | ME-GA35WCN   | 35 inch water column, diaphragm capsule gauge  |
| ME-GA5                  | ME-GA5N  | 5 PSI diaphragm capsule gauge                  |



# GAUGE ASSEMBLIES AND VALVES

Intended for bobtail drivers who are trained to conduct out of gas leak check tests. The SQTG Series gauge assembly give the service technician what is needed to test pressure regulators for flow set point and lock-up pressure in addition to leak check testing.

NOTE: Model number suffix A or B designates which type of pressure tap valve will be used. The A designates the type VA valve (Schrader) and B designates the type VB valve (1/4" flare).



ME-TGA  
or  
ME-TGB

**ME-TGA and ME-TGB Single Point Gauge Assemblies** come with a 30 PSIG gauge and are used for leak check tests at intermediate pressure at outlet of first stage regulator or inlet to second stage regulator.

**ME-KVA and ME-KVB Multi Point Kits** are gauge assemblies with 30 PSI gauges and built in regulators that limit the pressure to the gauge to 12 PSI so the gauge can be used for leak check testing at intermediate pressure taps or at tank pressure using the high pressure test block. Kit includes twelve 1/8" NPT valves and six 1/4" NPT pressure tap valves.



ME-KVB

| Part No. | Description                                     | Pressure Setting |
|----------|---|------------------|
| ME-TGA   | Type A (Schrader) Single Point Gauge Assembly   | 30 PSIG          |
| ME-TGB   | Type B (1/4" Flare) Single Point Gauge Assembly | 30 PSIG          |
| ME-KVA   | Type A Multi Point Test Kit                     | 30 PSIG          |
| ME-KVB   | Type B Multi Point Test Kit                     | 30 PSIG          |
| ME-SKVA  | Type A Universal Test Kit                       | 35" WC           |
| ME-SKVB  | Type B Universal Test Kit                       | 35" WC           |



ME-SKVA or ME-SKVB

ME-SKVA and ME-SKVB Universal Kits are gauge assemblies with 35" W.C. gauges and built-in regulators that limit the pressure to the gauge to 21" W.C. so the gauge can be used for leak check testing anywhere in the system. It can also be used to measure second stage, low pressure regulator set point and lock up pressure or appliance manifold pressure. Kit includes twelve 1/8 npt and six 1/4" NPT pressure tap valves.

# GAUGE ASSEMBLY PRESSURE TAP VALVES



ME-HSA

| Part No. | Description  |
|----------|--|
| ME-HSA   | Hose End Swivel Connector x Type A Pressure Tap Valve        |
| ME-HSB-S | Straight Hose End Swivel Connector 1/4" FNPT x 1/4" F/ Flare |
| ME-HSB   | Hose End Swivel Connector x Type B Pressure Tap Valve        |
| ME-HRS   | Gasket for ME-HSB (A) - Pkg of 25pc                          |



ME-VA2



ME-VB2

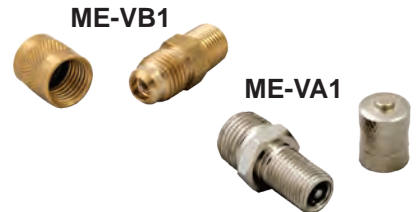

ME-VB1

ME-VA1

| Part No. | Description               | Connection | Connection |
|----------|---------------------------|------------|------------|
| ME-VA1   | Type A Pressure Tap Valve | 1/8" MNPT  | Schrader   |
| ME-VA2   |                           | 1/4" MNPT  |            |
| ME-VB1   | Type B Pressure Tap Valve | 1/8" MNPT  | 1/4" Flare |
| ME-VB2   |                           | 1/4" MNPT  |            |





# PRESSURE TEST ACCESSORIES

These accessories are easily adaptable to industry standard pressure test equipment and provide a very reliable, inexpensive, permanent way to test both high and low pressure lines in domestic tank installations.

## FEATURES

- Reliable method to test high and low pressure tap installations
- Provides an effective method to bleed vapor for pressure equalization and more accurate gauge readings
- Allows for an effective method to bleed vapor from the testing equipment prior to disconnect
- High quality liquid filled pressure gauge



**MEJ603HP**

| Part No.        | Outlet    | Inlet     | PSIG  | Factory Installed Vent Valve |
|-----------------|-----------|-----------|-------|------------------------------|
| <b>MEJ602*</b>  | 1/4" FNPT | 1/4" MNPT | —     | Yes                          |
| <b>MEJ603LP</b> | 1/4" FNPT | 1/4" MNPT | 0-15  | Yes                          |
| <b>MEJ603HP</b> | 1/4" FNPT | 1/4" MNPT | 0-300 | Yes                          |

\* Without gauge

These accessories are intended for first stage regulators with pressure taps in either the upstream or downstream positions.

| Part No.         | Connection | Connection | Approx. Length |
|------------------|------------|------------|----------------|
| 1/4" Hose ID     |            |            |                |
| <b>MER432-6</b>  | 1/8" MNPT  | 1/4" FNPT  | 6"             |
| <b>MER432-12</b> | 1/8" MNPT  | 1/4" FNPT  | 12"            |



**MER432 Series**

Designed to provide an inexpensive way to permanently install a pressure tap upstream or downstream from the first stage regulator. The #54 orifice port provides controlled line pressure for more accurate readings and protects test equipment from pressure spikes while allowing easy installation of pressure test monitoring devices.

| Part No.       |                  | Connection         | Connection | Port Hole with #54 Orifice |
|----------------|------------------|--------------------|------------|----------------------------|
| With Plug      | Without Plug     |                    |            |                            |
| <b>ME295</b>   | <b>ME295-1</b>   | Male Hard Nose POL | Female POL | 1/8" FNPT                  |
| <b>ME295SN</b> | <b>ME295SN-1</b> | Male Soft Nose POL | Female POL | 1/8" FNPT                  |
| <b>ME296</b>   | <b>ME296-1</b>   | 1/4" MNPT          | 1/4" FNPT  | 1/8" FNPT                  |
| <b>ME297</b>   | <b>ME297-1</b>   | 3/8" MNPT          | 3/8" FNPT  | 1/8" FNPT                  |
| <b>ME298</b>   | <b>ME298-1</b>   | 1/2" MNPT          | 1/2" FNPT  | 1/8" FNPT                  |
| —              | <b>MEJ595</b>    | 1/2" MNPT          | 1/2" FNPT  | 1/4" FNPT with no Orifice  |
| <b>ME299</b>   | <b>ME299-1</b>   | 3/4" MNPT          | 3/4" FNPT  | 1/8" FNPT                  |

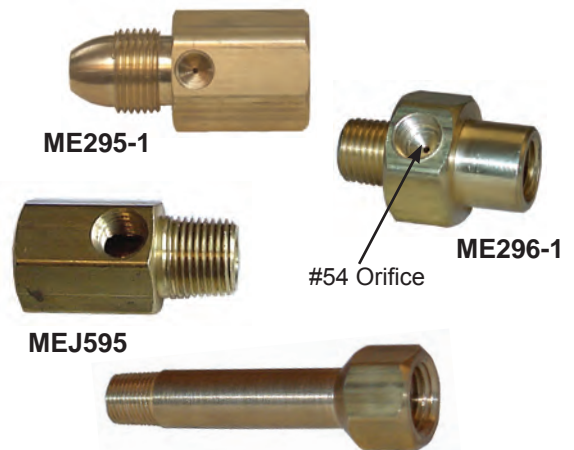

| Part No.      | Connection | Connection | Description |
|---------------|------------|------------|-------------|
| <b>MEJ604</b> | 1/4" FNPT  | 1/8" MNPT  | Extension   |

This check valve allows the line to be pressurized and adjusted to the desired pressure through the same valve.

NOTE: To help eliminate valve failure, the valve cap should remain on the valve when line is not be pressurized or adjusted. Any dirt, debris, water or other contaminants can potentially jam the valve or compromise the sealing surface causing the valve to leak.



| Part No.            | Connection | Connection      |
|---------------------|------------|-----------------|
| <b>ME10BTK-1-01</b> | 1/8" FNPT  | 5/16"-32 Female |



| Part No.          | Connection | Connection    | Thread Sealant |
|-------------------|------------|---------------|----------------|
| <b>ME-VA2</b>     | 1/4" MNPT  | 5/16"-32 Male | No             |
| <b>ME-VA1</b>     | 1/8" MNPT  | 5/16"-32 Male | No             |
| <b>MEJ608B-02</b> | 1/8" MNPT  | 5/16"-32 Male | Yes            |



|  | Part No.                             | Description   |
|--|--------------------------------------|---|
| Acme Adapters                              | ME251-02                             | 3-1/4" Acme Screen  |
|  | ME251-03                             | 3-1/4" Acme Retaining Ring for Screen   |
| Acme Gaskets                               | MEW4                                 | 1-1/4" Acme Flat Gasket for Motor Fuel  |
|  | MEW3                                 | 1-1/4" Acme Flat Gasket   |
|  | MEW2                                 | 1-3/4" Acme Flat Gasket   |
|  | MEW5                                 | 2-1/4" Acme Flat Gasket   |
|  | MEW6                                 | 3-1/4" Acme Flat Gasket   |
|  | MEW7                                 | 4-1/4" Acme Flat Gasket   |
| Back Check Valves                          | ME868-16-05                          | Universal 1-1/4" - 2" Replacement Excelsa-Flange™ O-Ring                                |
|  | ME870-6-06                           | 3/4" Back Check Valves O-ring   |
|  | ME870-10-06                          | 1-1/4" Back Check Valves O-ring   |
|  | ME870-16-06                          | 2" Back Check Valves O-ring   |
|  | ME870-24-06                          | 3" Back Check Valves O-ring   |
| Bypass Valves<br>(High Flow)               | ME840-6K                             | 3/4" & 1" High Flow Bypass Complete Repair Kit - Less Spring                            |
|  | ME840-6SRK                           | 3/4" & 1" High Flow Bypass Complete Seal Repair Kit                                     |
|  | ME840-8-108-60                       | 3/4" & 1" High Flow Bypass Valve Replacement Spring 25-60 PSI (Blue)                    |
|  | ME840-8-108-150                      | 3/4" & 1" High Flow Bypass Valve Replacement Spring 50-150 PSI (Green)                  |
|  | ME840-8-108-225                      | 3/4" & 1" High Flow Bypass Valve Replacement Spring 100-225 PSI (Red)                   |
|  | ME870-24-06                          | 3/4" & 1" High Flow Bypass Valve Replacement Bonnet O-Ring                              |
|  | ME840CK                              | 1-1/4" - 2" Classic Poppet with Nitrile O-rings Complete Repair Kit                     |
|  | ME840CVK                             | 1-1/4" - 2" Classic Poppet with FKM O-rings Complete Repair Kit                         |
|  | ME840K                               | 1-1/4" - 2" Standard Poppet with Nitrile O-rings Complete Repair Kit                    |
|  | ME840VK                              | 1-1/4" - 2" Standard Poppet with FKM O-rings Complete Repair Kit                        |
|  | ME840SRK                             | 1-1/4" - 2" High Flow Bypass Seal Repair Kit  |
|  | ME840-16-108-40                      | 1-1/4" - 2" High Flow Bypass Valve Spring 20-40 PSI (Blue)                              |
|  | ME840-16-108-70                      | 1-1/4" - 2" High Flow Bypass Valve Spring 41-70 PSI (Green)                             |
|  | ME840-16-108-90                      | 1-1/4" - 2" High Flow Bypass Valve Spring 71-90 PSI (Yellow)                            |
|  | ME840-16-108-125                     | 1-1/4" - 2" High Flow Bypass Valve Spring 91-125 PSI (Orange)                           |
|  | ME840-16-108-150                     | 1-1/4" - 2" High Flow Bypass Valve Spring 126-150 PSI (Red)                             |
|  | ME868-16-05                          | 1-1/4" - 2" Universal 4 Bolt Flange O-Ring  |
|  | ME840-16-109                         | 1-1/4" - 2" Universal Bonnet O-Ring   |
|  | ME840-16-110                         | 1-1/4" - 2" Universal Spring Guide O-Ring   |
|  | ME840-16-104                         | 1-1/4" - 2" Universal Valve Poppet - Stainless Steel                                    |
|  | ME840C-16-104                        | 1-1/4" - 2" Classic Style Valve Poppet - Stainless Steel                                |
|  | ME840-24K                            | 3" High Flow Bypass Complete Repair Kit - Less Spring                                   |
|  | ME840-24SRK                          | 3" High Flow Bypass Seal Repair Kit   |
|  | ME840-24-105-75                      | 3" High Flow Bypass Valve Spring 25-75 PSI  |
|  | ME840-24-105-100                     | 3" High Flow Bypass Valve Spring 0-100 PSI  |
|  | ME840-24-105-200                     | 3" High Flow Bypass Valve Spring 100-200 PSI  |
|  | ME904SK-24                           | 3"-300# Bypass Valve Spiral Ring Flange Gasket - Carbon Steel                           |
| ME980SK-24                                 | 3"-300# Bypass Valve Flange Stud Kit |   |
| Combination Valves                         | ME815K                               | Bonnet Assembly for ME830   |
|  | MEP449S-101                          | Replacement Protective Weather Boot   |
| Container Fill Valves                      | ME601-902                            | Replacement 1-3/4" F. Acme Cap w/ Lanyard - Plastic                                     |
|  | ME601-6SRK                           | Complete Seal Repair Kit For ME601-6 Fill Valve   |
|  | ME601-10SRK                          | Complete Seal Repair Kit For ME601-10 Fill Valve  |
|  | ME601-10-108                         | Replacement Nylon Body Gasket For ME601-10  |
|  | ME601-10-901                         | Replacement Molded Valve Poppet For ME601-10  |
| Dispensing Filter<br>(LPG/NH3 - High Flow) | ME680-8-ERK                          | 1" High Capacity Replacement Filter Element Kit - includes element, o-rings & lubricant |

REPLACEMENT PARTS & REPAIR KITS

|   | Part No.  | Description   |
|---|---|---|
| Dispensing Filter (LPG/NH3 - High Flow)   | ME680-8-ERK   | 1" High Capacity Replacement Filter Element Kit - includes element, o-rings & lubricant |
| Dispensing Valves (Quick-Acting)  | ME800-HRK   | ME800, ME810, and ME820 Series Handle Repair Kit  |
| ESV<br>Emergency<br>Shutoff<br>Valves   | ME980-903K  | 1-1/4"-3" ESV Cable Latch Assembly  |
|   | ME980-904K  | 1-1/4"-3" ESV Pneumatic Latch Assembly  |
|   | ME980-905   | Universal Thermally Activated Remote Cable Release Mechanism                            |
|   | ME980-905-25  | Universal Thermally Activated Remote Cable Release Mechanism w/ 25' Cable               |
|   | ME980-905-50  | Universal Thermally Activated Remote Cable Release Mechanism w/ 50' Cable               |
|   | ME980-906-25  | Universal Remote Release Cable - 25'  |
|   | ME980-906-50  | Universal Remote Release Cable - 50'  |
|   | ME980-907   | Remote Thermally Activated Elbow 1/4" CC Inlet - For Pneumatic Latch Systems            |
|   | ME980HRK  | 1-1/4"-3" ESV Replacement Handle Assy.  |
|   | ME980PGA  | 1-1/4"-3" ESV Packing Gland Assembly  |
|   | ME980-6K  | 3/4" - 1" ESV Complete Repair Kit   |
|   | ME980-6SRK  | 3/4" - 1" ESV Valve Seal Repair Kit   |
|   | ME980-6-902   | ESV Valve Pneumatic Release Replacement Kit   |
|   | ME980-6-903   | ESV Valve Cable Release Replacement Kit   |
|   | ME980-10-901  | 1-1/4" Replacement (ESV) & Back Check Valve Clapper Assy.                               |
|   | ME980-16-901  | 2" Replacement (ESV) & Back Check Valve Clapper Assy.                                   |
|   | ME980-24-901  | 3" Replacement (ESV) & Back Check Valve Clapper Assy.                                   |
|   | ME980-10K   | 1-1/4" (ESV) Complete Valve Repair Kit  |
|   | ME980-16K   | 2" (ESV) Complete Valve Repair Kit  |
|   | ME980-24K   | 3" (ESV) Complete Valve Repair Kit  |
|   | ME980-10SRK   | 1-1/4" (ESV) Seal Repair Kit  |
| ME980-16SRK   | 2" (ESV) Seal Repair Kit                                |   |
| ME980-24SRK   | 3" (ESV) Seal Repair Kit                                |   |
| <i>Excelerator</i> <sup>™</sup><br>Internal Combination<br>Valves 1-1/4"          | ME1000F-101-40  | Replacement 20 Mesh Screen  |
| <i>Excelerator</i> <sup>™</sup><br>Internal Valves<br>1-1/4" Threaded             | ME990-10-VRK  | Excelerator 1-1/4" Internal Valve Rebuild Kit   |
|   | ME990-10-SRK  | Excelerator 1-1/4" Internal Valve Seal Repair Kit                                       |
|   | ME990-10-PRK  | Excelerator 1-1/4" - 1-1/2" Internal Valve Stem Packing Repair Kit                      |
|   | ME990-10-PGA  | Excelerator 1-1/4" - 1-1/2" Internal Valve Stem Packing Gland Assy.                     |
|   | ME990-10-106-35   | Excelerator 1-1/4" Internal Valve Excess Flow Spring - 35 GPM (Blue)                    |
|   | ME990-10-106-55   | Excelerator 1-1/4" Internal Valve Excess Flow Spring - 55 GPM (Green)                   |
|   | ME990-10-106-85   | Excelerator 1-1/4" Internal Valve Excess Flow Spring - 85 GPM (Orange)                  |
|   | ME990-10-129  | Excelerator 1-1/4" Internal Valve Manual Lever  |
|   | MEP147-01   | 1-1/4" Plated Steel Cable Connector Ring For 1-1/4"-3" Internal Valves                  |
| <i>Excelerator</i> <sup>™</sup><br>Internal Valves<br>1-1/2" Threaded<br>Tee Body | ME990-12-VRK  | 1-1/2" Internal Valve Complete Repair Kit   |
|   | ME990-12-SRK  | 1-1/2" Internal Valve Seal Repair Kit   |
|   | ME990-10-PGA  | 1-1/4" - 1-1/2" Internal Valve Packing Gland Assembly                                   |
|   | ME990-10-PRK  | 1-1/4" - 1-1/2" Internal Valve Stem Packing Repair Kit                                  |
|   | MEP147-01   | Cable Connector Ring for 1-1/4" - 3" Excelerator <sup>™</sup> Internal Valves           |
|   | ME990-10-129  | Manual Operating Lever  |
|   | ME990-160   | Universal Internal Valve Fusible Link - 212° F.   |
|   | ME992-12-106-45   | 1-1/2" Internal Valve Excess Flow Spring - 45 GPM (Orange)                              |
| ME992-12-106-60   | 1-1/2" Internal Valve Excess Flow Spring - 60 GPM (Red) |   |

|   | Part No.   | Description  |
|---|--|--|
| <b>Excellerator™</b><br>Internal Valves<br>1-1/2" Threaded Tee Body                     | ME992-12-106-85                                    | 1-1/2" Internal Valve Excess Flow Spring - 85 GPM (Yellow)                     |
|   | ME992-12-106-110                                   | 1-1/2" Internal Valve Excess Flow Spring - 110 GPM (Purple)                    |
|   | ME992-12-106-125                                   | 1-1/2" Internal Valve Excess Flow Spring - 125 GPM (Brown)                     |
| <b>Excellerator™</b><br>Internal Valves<br>2" & 3" Threaded<br>&<br>Threaded Tee Body   | ME990-140  | 2"-3" Manual Operating Lever - Standard  |
|   | ME990-160  | Universal Internal Valve Fusible Link 212 Degrees                              |
|   | ME990-16-VRK                                       | 2" Internal Valve Rebuild Kit  |
|   | ME990-16-SRK                                       | 2" Internal Valve Seal Repair Kit  |
|   | ME990-24-VRK                                       | 3", 3"DF, 3"DFM Internal Valve Rebuild Kit                                     |
|   | ME990-24-SRK                                       | 3", 3"DF, 3"DFM Internal Valve Seal Repair Kit                                 |
|   | ME990-PRK  | 2" & 3" Internal Valve Stem Packing Repair Kit                                 |
|   | ME990-PGA  | 2" & 3" Internal Valve Stem Packing Gland Assy.                                |
|   | ME990-16-106-110                                   | 2" Internal Valve Excess Flow Spring - 110GPM (Yellow)                         |
|   | ME990-16-106-160                                   | 2" Internal Valve Excess Flow Spring - 160GPM (Green)                          |
|   | ME990-16-106-260                                   | 2" Internal Valve Excess Flow Spring - 260GPM (Blue)                           |
|   | ME990-106-175                                      | 3" Internal Valve Excess Flow Spring - 175GPM (Purple)                         |
|   | ME990-106-250                                      | 3" Internal Valve Excess Flow Spring - 250GPM (Black)                          |
|   | ME990-106-300                                      | 3" Internal Valve Excess Flow Spring - 300GPM (Green)                          |
|   | ME990-106-375                                      | 3" Internal Valve Excess Flow Spring - 375GPM (Yellow)                         |
|   | ME990-106-400                                      | 3" Internal Valve Excess Flow Spring - 400GPM (Red)                            |
|   | ME990-106-475                                      | 3" Internal Valve Excess Flow Spring - 475GPM (Silver)                         |
|   | ME990-106-500                                      | 3" Internal Valve Excess Flow Spring - 500GPM (White)                          |
| MEP147-01   | Cable Connector Ring for 1-1/4"-3" Internal Valves |  |
| <b>Excellerator™</b><br>Internal Valves<br>3" Flanged<br>&<br>Double Flanged<br>Off-Set | ME990-24-SRK                                       | Internal Valve Seal Repair Kit (less ME990-3F Series)                          |
|   | ME990-24-VRK                                       | 3", 3DF, 3DFM Internal Valve Complete Rebuild Kit (less ME990-3F Series)       |
|   | ME990-3DF-121                                      | 3" Double Flange Self-Guiding Poppet Retaining Nut                             |
|   | ME990-3DF-122                                      | 3" Double Flange Retaining Nut Roll Pin  |
|   | ME990-3DF-138                                      | 3" Double Flange Screen Mounting Post  |
|   | ME990-3DF-144                                      | 3" Double Flange Filter Screen Perforated - Stainless Steel                    |
|   | ME990-3DF-145                                      | 3" Double Flange Filter Cap Perforated - Stainless Steel                       |
|   | ME990-3DF-146                                      | 3" Double Flange Screen Mounting Post - Locknut                                |
|   | ME990-3DF-148                                      | 3" Double Flange Stem Guide Bracket  |
|   | ME990-3DF-153                                      | 3" Single & Double Flange Internal Valve Inlet Flange Gasket - Stainless Steel |
|   | ME990-3F-VRK                                       | 3" Single Flange Internal Valve Complete Rebuild Kit                           |
|   | ME990-3F-SRK                                       | 3" Single Flange Internal Valve Seal Repair Kit                                |
|   | ME990-3F-PRK                                       | 3" Single Flange Internal Valve Stem Packing Repair Kit                        |
|   | ME990-3F-PGA                                       | 3" Single Flange Internal Valve Stem Packing Gland Assembly.                   |
|   | ME990-3F-109                                       | 3" Single Flange Internal Valve Outlet Flange Gasket - Stainless Steel         |
|   | ME990-3F-110                                       | 3" Single Flange Internal Valve Mounting Stud (5-3/4" OAL B7 Xylan Coated)     |
|   | ME990-3F-24-140                                    | 3" Modified Single & Double Flange Manual Operating Lever - Short              |
|   | ME990-3F-24-150                                    | 3" & 4" Internal Valve Mounting Sleeve / Bushing                               |
|   | ME990-PRK  | 2" & 3" Internal Valve Stem Packing Repair Kit (less ME990-3F Series)          |
|   | ME990-PGA  | 2" & 3" Internal Valve Packing Gland Assy. (less ME990-3F Series)              |
|   | ME990-106-175                                      | 3" Internal Valve Excess Flow Spring - 175GPM (Purple)                         |
|   | ME990-106-250                                      | 3" Internal Valve Excess Flow Spring - 250GPM (Black)                          |
|   | ME990-106-300                                      | 3" Internal Valve Excess Flow Spring - 300GPM (Green)                          |
|   | ME990-106-375                                      | 3" Internal Valve Excess Flow Spring - 375GPM (Yellow)                         |
|   | ME990-106-400                                      | 3" Internal Valve Excess Flow Spring - 400GPM (Red)                            |
|   | ME990-106-475                                      | 3" Internal Valve Excess Flow Spring - 475GPM (Silver)                         |
|   | ME990-106-500                                      | 3" Internal Valve Excess Flow Spring - 500GPM (White)                          |

|  | Part No.                                      | Description  |
|--|---|--|
| <b>Excelerator™</b><br>Internal Valves<br>3" Flanged<br>&<br>Double Flanged<br>Off-Set | ME990-140                                     | 3" Manual Operating Lever - Standard   |
|  | ME990-151                                     | 3" Internal Valve Tank Side Mounting Stud 3-1/2" OAL B7                            |
|  | ME990-160                                     | Universal Internal Valve Fusible Link - 212° F.                                    |
|  | ME930-244                                     | 3" Double Flange Stem Guide Bracket Screw #10-32                                   |
|  | ME904SK-01                                    | 3" Modified Single & Double Flange Internal Valve Tank Side Mount Stud 3" OAL - B7 |
|  | ME904SK-02                                    | 3" Internal Valve Mounting Stud Standard Hex Nut 3/4-10 B8                         |
|  | ME904S-3F-027                                 | Excelerator 3" Double Flange Outlet/3" Modified Inlet Flange Gasket                |
|  | ME990-3DFO-102                                | Offset Stand-Off 1/2-13UNC-2A x 5/16-24UNF-2A x 1.67"OAL - SS                      |
|  | ME990-3DFO-103                                | Offset Gland Plug 1-3/8-12UNF-2A x 1-5/8"HX - SS                                   |
|  | MEP147-01                                     | Cable Connector Ring for 1-1/4" - 3" Internal Valves                               |
| <b>Excelerator™</b><br>Internal Valves<br>4" Flanged                                   | MEP990-4F                                     | Manual Latch For 4" Internal Valves  |
|  | ME990-4F-VRK                                  | 4" Internal Valve Rebuild Kit  |
|  | ME990-4F-SRK                                  | 4" Internal Valve Seal Repair Kit  |
|  | ME990-4F-PRK                                  | 4" Internal Valve Stem Packing Repair Kit  |
|  | ME990-4F-PGA                                  | 4" Internal Valve Stem Packing Gland Assy.   |
|  | ME990-4F-146                                  | 4" Internal Valve Filter Screen Retain Bolt - 1/4-28                               |
|  | ME990-4F-153                                  | 4" Internal Valve Inlet Flange Gasket  |
|  | ME990-4F-172                                  | 4" Internal Valve Outlet Flange Gasket   |
|  | ME990-4F-106-375                              | 4" Internal Valve Excess Flow Spring - 375GPM (Cyan)                               |
|  | ME990-4F-106-500                              | 4" Internal Valve Excess Flow Spring - 500GPM (Black)                              |
|  | ME990-4F-106-650                              | 4" Internal Valve Excess Flow Spring - 650GPM (Green)                              |
|  | ME990-4F-106-850                              | 4" Internal Valve Excess Flow Spring - 850GPM (Yellow)                             |
|  | ME990-4F-106-1250                             | 4" Internal Valve Excess Flow Spring - 1250GPM (Red)                               |
|  | ME990-4F-106-1500                             | 4" Internal Valve Excess Flow Spring - 1500GPM (White)                             |
|  | ME990-4F-144                                  | 4" Internal Valve Filter Screen Perforated - Stainless Steel                       |
|  | ME990-4F-145                                  | 4" Internal Valve Filter Cap Perforated - Stainless Steel                          |
|  | ME990-4F-162                                  | 4" Internal Valve Filter Screen/Cap #5 MESH  |
|  | ME990-4F-151                                  | 4" Internal Valve Mounting Stud 6-3/4"OAL B7 Xylan Coated                          |
|  | ME990-152                                     | 3" Modified & 4" Internal Valve Mounting Stud Heavy Hex Nut 3/4-10 B8              |
| ME990-3F-24-150  | 3 & 4" Internal Valve Mounting Sleeve/Bushing |  |
| <b>Excelsa-Flange™</b> Series<br>Excess Flow Valves                                    | MEP183-102                                    | Replacement Torque Posts   |
| External Pressure<br>Relief Valves   | MEPS-UT12X                                    | Replacement Poly Cap for MEVS-PVE431 & 431B  |
|  | MEPS-431                                      | 1" FNPT Pipeaway Adapter for MEVS-PVE431 & 431B                                    |
|  | MEV250-015                                    | MEV250 Series Stainless Steel Weep Hole Deflector                                  |
|  | MEV250-013                                    | Relief Valve Dust Cap with Lanyard   |
| Fill Check Adapters  | ME571-06                                      | Replacement Plastic Spacer Ring For ME571  |
|  | ME571-2-03                                    | Replacement Nose Gasket For ME571  |
| Float Gauges<br>(Accu-Max)   | MES-1284-21-1                                 | Universal ASME/DOT lift truck float gauge dial screw                               |
|  | MES-1284-21-2                                 | Junion float gauge head gasket   |
|  | ME930-905                                     | ME930 Series 4" DOT Dial—Glow/Black  |
|  | ME930C-905                                    | ME930 Series 4" DOT Dial—Silver/Black  |
|  | ME940-905                                     | ME940 Series 8" ASME Dial—Glow/Black   |
|  | ME940C-905                                    | ME940 Series 8" ASME Dial—Silver/Black   |
| Flow Indicating<br>Check Valve   | ME981-901                                     | 1-1/4" - 3" Replacement Swing Check Indicator Dial                                 |
| Fuse Plugs   | ME205-013                                     | 1/8" MPT Thermal Safety Plug   |
|  | ME206-09                                      | 3/8 MPT Thermal Safety Plug 212 Deg  |
| Gas Box  | ME952-07                                      | ME951 and ME952 Series Dust Cap  |

|                                       | Part No.   | Description   |
|---------------------------------------|--|---|
| Globe & Angle Valves                  | ME815K   | 1/2", 3/4" & 1" Angle & Globe Valve Complete Bonnet Assembly                  |
|                                       | ME815-10BRK  | 1-1/4" & 1-1/2" Angle & Globe Valve Complete Bonnet Assembly                  |
|                                       | ME815-10SRK  | 1-1/4" & 1-1/2" Angle & Globe Valve Replacement Seal Repair Kit               |
|                                       | ME815-10/16HRK   | 1-1/4", 1-1/2" & 2" Angle & Globe Valve Replacement Handle & Retaining Nut    |
|                                       | ME815-16BRK  | 2" Angle & Globe Valve Complete Bonnet Assembly                               |
|                                       | ME815IBC-16BRK   | 2" Angle & Globe Valve with Integrated Back Check Complete Bonnet Assembly    |
|                                       | ME815P-16BRK   | 2" Angle & Globe Valve with Pilot Complete Bonnet Assembly                    |
|                                       | ME815-16SRK  | 2" Angle & Globe Valve Replacement Seal Repair Kit                            |
|                                       | ME815IBC-16SRK   | 2" Angle & Globe Valve with Integrated Back Check Replacement Seal Repair Kit |
|                                       | ME815P-16SRK   | 2" Angle & Globe Valve with Pilot Replacement Seal Repair Kit                 |
|                                       | ME815-24BRK  | 3" Angle & Globe Valve Replacement Bonnet Assembly                            |
|                                       | ME815-24SRK  | 3" Angle & Globe Valve Replacement Seal Kit                                   |
|                                       | ME815-24HRK  | 3" Angle & Globe Valve Replacement Handle Kit                                 |
|                                       | ME825-3F-BRK   | 3" Flanged Globe Valve Complete Bonnet Repair Kit                             |
|                                       | ME825-3F-SRK   | 3" Flanged Globe Valve Seal Repair Kit  |
|                                       | ME825-4F-BRK   | 4" Flanged Globe Valve Complete Bonnet Repair Kit                             |
|                                       | ME825-4F-SRK   | 4" Flanged Globe Valve Seal Repair Kit  |
|                                       | ME980SK-24   | 3" & 4"-300LB ESV & Globe Valve Flange Stud Kit                               |
|                                       | ME904S-3F-027  | 3"-300 LB Spiral Ring Flange Gasket-Carbon Steel                              |
|                                       | ME904S-4F-027  | 4"-300 LB Spiral Ring Flange Gasket-Carbon Steel                              |
| Hose Clamps                           | ME3162-08-02K  | 1 Pair 1/2" Hose Clamps & Bolts   |
|                                       | ME3162-12-02K  | 1 Pair 3/4" Hose Clamps & Bolts   |
|                                       | ME3162-16-02K  | 1 Pair 1" Hose Clamps & Bolts   |
|                                       | ME3162-20-02K  | 1 Pair 1-1/4" Hose Clamps & Bolts   |
|                                       | ME3162-24-02K  | 1 Pair 1-1/2" Hose Clamps & Bolts   |
|                                       | ME3162-32-02K  | 1 Pair 2" Hose Clamps & Bolts   |
| Hose End Holster                      | MEP801-03  | MEP801 Series Black Urethane Holster Sleeve                                   |
|                                       | MEP801-04  | MEP801 Series Black Urethane Holster Strap                                    |
| Hose End Swivel                       | ME850SS-K  | Seal Repair Kit   |
| Hose End Valves                       | ME800-HRK  | ME800 and ME800EXT Series Handle Repair Kit                                   |
|                                       | ME800-LSRK   | ME800 and ME800EXT Series Lower Seal Repair Kit                               |
|                                       | ME800-SARK   | ME800 and ME800EXT Series Stem Assembly Repair Kit                            |
|                                       | ME800-USRK   | ME800 and ME800EXT Series Upper Seal Repair Kit                               |
| Industrial Regulator MEGR-1133 Series | MEGR-1133H-01/05   | 2-5PSI Spring For MEGR-1133H Series   |
| Industrial Regulator MEGR-164 Series  | MEGR-164-01/125  | Replacement 1-125PSI Spring for MEGR-164 Series                               |
|                                       | MEGR-164-03  | Replacement Diaphragm for MEGR-164 Series                                     |
| Industrial Regulator MEGR-198H Series | MEGR-198H-03   | Replacement Diaphragm for MEGR-198H Series                                    |
| Industrial Regulator MEGR-199 Series  | MEGR-199-01/10   | Replacement Spring For MEGR-199 Series 2-10PSI - Blue                         |
|                                       | MEGR-199-01/15   | Replacement Spring For MEGR-199 Series 5-15PSI - Brown                        |
|                                       | MEGR-199-01/20   | Replacement Spring For MEGR-199 Series 10-20PSI - Green                       |
|                                       | MEGR-199-01/5  | Replacement Spring For MEGR-199 Series 1-5PSI - Yellow                        |
|                                       | MEGR-199-01/65   | Replacement Spring For MEGR-199 Series 10-65PSI - Green Stripe                |
|                                       | MEGR-199-02/1.125  | Replacement Main Orifice For MEGR-199 Series 1-1/8"                           |
|                                       | MEGR-199-03  | Replacement Diaphragm For MEGR-199 Series                                     |
|                                       | MEGR-199-05  | Replacement Body Housing Gasket For MEGR-199 Series                           |
| MEGR-199-06                           | Replacement Main Seat Disc For MEGR-199 Series - Nitrile |   |

|  | Part No.                                 | Description  |
|--|--|--|
| Industrial Regulator<br>MEGR-CS1200 Series | MEGR-CS1200-02/25                        | 1/4" Orifice for MEGR-CS1200 Series                  |
|  | MEGR-CS1200-02/312                       | 5/16" Orifice for MEGR-CS1200 Series                 |
|  | MEGR-CS1200-02/38                        | 3/8" Orifice for MEGR-CS1200 Series                  |
|  | MEGR-CS1200-02/50                        | 1/2" Orifice for MEGR-CS1200 Series                  |
|  | MEGR-CS1200-02/625                       | 5/8" Orifice for MEGR-CS1200 Series                  |
|  | MEGR-CS1200-01/6.5                       | 3.5-6.5"WC Spring for MEGR-CS1200 Series (Red)       |
|  | MEGR-CS1200-01/14                        | 6-14"WC Spring for MEGR-CS1200 Series (Green)        |
|  | MEGR-CS1200-01/33                        | 12-33"WC Spring for MEGR-CS1200 Series (Orange)      |
|  | MEGR-CS1200-04                           | Replacement seat assembly for MEGR-CS1200 Series     |
| Industrial Regulator<br>MEGR-S1202 Series  | MEGR-S1202-RK                            | MEGR-S1202 GH Series Complete Rebuild Kit            |
|  | MEGR-S1202-01/9                          | 5-9"WC Spring for MEGR-S1202G Series (Black)         |
|  | MEGR-S1202-01/18                         | 8.5-18"WC Spring for MEGR-S1202H Series (White)      |
|  | MEGR-S1202-01/30                         | 14-30"WC Spring for MEGR-S1202H Series (Green)       |
|  | MEGR-S1202-01/2                          | 1-2 PSI Spring for MEGR-S1202H Series (Blue)         |
|  | MEGR-S1202-01/3.25                       | 1.5-3.25PSI Spring for MEGR-S1202H Series (Orange)   |
|  | MEGR-S1202-01/5                          | 2-5PSI Spring for MEGR-S1202H-"XX"L only (Yellow)    |
|  | MEGR-S1202-02/50                         | 1/2" Orifice for MEGR-S1202 Series                   |
|  | MEGR-S1202-02/75                         | 3/4" Orifice for MEGR-S1202 Series                   |
|  | MEGR-S1202-02/250                        | 1/4" Orifice for MEGR-S1202 Series                   |
|  | MEGR-S1202-02/375                        | 3/8" Orifice for MEGR-S1202 Series                   |
|  | MEGR-S1202-02/100                        | 1" Orifice for MEGR-S1202 Series                     |
|  | MEGR-S1202-02/1187                       | 1-3/16" Orifice for MEGR-S1202 Series                |
|  | Industrial Regulator<br>MEGR-1289 Series | MEGR-1289-8-01/4.5                                   |
| MEGR-1289-8-01/15                          |  | 4-15 PSI Spring For MEGR-1289 1" Series (Red)        |
| MEGR-1289-8-01/20                          |  | 10-20 PSI Spring For MEGR-1289 1" Series (Silver)    |
| MEGR-1289-8-01/50                          |  | 15-50 PSI Spring For MEGR-1289 1" Series (Green)     |
| MEGR-1289-16-01/18                         |  | 7-18"WC Spring For MEGR-1289 2" Series (Blue)        |
| MEGR-1289-16-01/2.25                       |  | .5-2.25PSI Spring For MEGR-1289 2" Series (Grey)     |
| MEGR-1289-16-01/7                          |  | 1.75-7 PSI Spring For MEGR-1289 2" Series (Green)    |
| MEGR-1289-16-01/10                         |  | 4-10 PSI Spring For MEGR-1289 2" Series (Red)        |
| MEGR-1289-16-04                            |  | Replacement seal gasket for MEGR-1289 2" Series      |
| MEGR-1289-16-05                            |  | Replacement dust cap for MEGR-1289 2" Series         |
| Industrial Regulator<br>MEGR-1627 Series   | MEGR-1627-01/20                          | 5-20 PSI Spring For MEGR-1627 Series (Yellow)        |
|  | MEGR-1627-01/40                          | 15-40 PSI Spring For MEGR-1627 Series (Green)        |
|  | MEGR-1627-01/95                          | 10-95 PSI Spring For MEGR-1627 Series (Blue)         |
|  | MEGR-1627-02/25                          | 1/4" Aluminum Orifice For MEGR-1627 Series           |
|  | MEGR-1627-02/38                          | 3/8" Aluminum Orifice For MEGR-1627 Series           |
|  | MEGR-1627-02/50                          | 1/2" Alum Orifice For MEGR-1627 Series               |
|  | MEGR-1627-04                             | Vent Assembly For MEGR-1627 Series                   |
|  | MEGR-1627-05                             | Adjusting Screw Cover - Plastic For MEGR-1627 Series |
|  | MEGR-1627-03                             | Replacement Diaphragm For MEGR-1627 Series           |
|  | MEGR-1627-03R                            | Replacement Diaphragm For MEGR-1627R Series          |
| Industrial Regulator<br>MEGR-1630 Series   | MEGR-1630-01/10                          | 3-10 PSI Spring For MEGR-1630 Series (Red stripe)    |
|  | MEGR-1630-01/20                          | 8-20 PSI Spring For MEGR-1630 Series (Olive drab)    |
|  | MEGR-1630-01/30                          | 17-30 PSI Spring For MEGR-1630 Series (Silver)       |
|  | MEGR-1630-02/25                          | 1/4" Orifice For MEGR-1630 Series                    |
|  | MEGR-1630-02/38                          | 3/8" Orifice For MEGR-1630 Series                    |
|  | MEGR-1630-02/50                          | 1/2" Orifice For MEGR-1630 Series                    |
|  | MEGR-1630-04                             | Vent Assembly For MEGR-1630 Series                   |
|  | MEGR-1630-03                             | Replacement Diaphragm For MEGR-1630 Series           |

|   | Part No.          | Description   |
|---|-------------------|---|
| Internal Valve Actuators                  | ME205-013         | 212° F. Thermal Safety Plug for ME205, ME205R, ME225, ME226, ME227, ME228, ME552, ME710             |
|   | ME206-09          | 212° F. Thermal Safety Plug for ME206, ME207, ME207SF, ME208SF                                      |
| Keys                                      | ME530-03          | ME530, ME531, ME532 and ME533 Series Key  |
|   | ME578-02          | ME578 and ME600 Series Key  |
| Liquid Withdrawal Adapters & Tank Valves  | ME461             | 1-5/8" UNS Female Thread Replacement Cap and Gasket for ME460 & ME462                               |
|   | ME461S            | 1-5/8" UNS Female Thread Replacement Cap and Gasket for ME462S                                      |
|   | ME461SS           | 1-5/8" UNS Female Thread Replacement Cap and Gasket for ME462SS                                     |
|   | ME458-03          | ME458, ME460 and ME462 Series Nylon Gasket  |
|   | ME458-04          | ME458 Series Nitrile O-ring   |
|   | MEP449S-101       | ME449EXS/22 Replacement Protective Weather Boot   |
| Low Pressure Test Kits                    | ME50-H            | ME50P-2 and ME60P-2 Hose and Bell Assembly  |
|   | ME60P-2-01        | ME60P-2 Screw Driver to Adjust Gauge  |
| Manifold (Relief Valves)                  | ME904S-3F-027     | Replacement Excelerator 3" Double Flange Outlet/3" Modified Inlet Flange Gasket                     |
|   | ME904S-4F-027     | Replacement 4" Modified Flange Flexatalic Gasket For ME904S-4F                                      |
|   | ME904SK           | Quad-Port, 3/4-10UNC Mounting Stud Kit W/Nuts - 8Studs  |
|   | ME904SK-02        | Replacement 3" Internal Valve Mounting Stud Standard Hex Nut 3/4-10 B8                              |
|   | MEV125-109        | Replacement Plastic Rain Cap for MEV125 Series Relief Valves - Black                                |
| Moto-Seal                                 | ME795-3-02        | Replacement Tip Seal  |
| Multipurpose Withdrawal Valves            | ME670-BRK         | Replacement Bonnet Assembly for ME670, ME671, ME672 & ME673 Series Valves                           |
|   | ME670-SRK         | Replacement Seal Repair Kit for ME670, ME671, ME672 & ME673 Series Valves                           |
|   | ME670-USRK        | Replacement Upper Stem Seal Repair Kit for ME670, ME671, ME672 & ME673 Series                       |
|   | ME670-HRK         | Replacement Handle Repair Kit for ME670, ME671, ME672 & ME673 Series Valves                         |
|   | ME671IBC-BRK      | Replacement Bonnet Assembly for ME671IBC Series Valves  |
|   | ME671IBC-SRK      | Replacement Seal Repair Kit for ME671IBC Series Valves  |
|   | ME670-107         | Replacement Data Plate for ME670DEX   |
|   | ME670-108         | Replacement Data Plate for ME670DBC   |
| Multi-Service ASME Container Vapor Valves | ME9101C1BRK       | Complete ASME/DOT Valve Replacement Bonnet Assembly w/ Handwheel                                    |
|   | ME9101BRK         | Replacement Universal Bonnet Repair Assembly, Less Handwheel - Fits all MEC Service Valves          |
|   | ME9101C1-102      | ASME/DOT Replacement Service Valve Handwheel - Zinc   |
|   | ME9101P5BRK       | Bonnet Repair Kit, 3/4"MNPT Motor Fuel Service Valve  |
|   | ME9101P5-109      | Universal Replacement Handwheel Retaining Screw #10-32  |
|   | ME9101P5-114      | Universal Replacement Service Valve Bonnet Seal   |
|   | MES-1901S         | Replacement Handle for MES-PVE3250C, 3250CLG. ALG7T, ADT-7, CLM, 1427B, 1447B & 2035A Series Valves |
|   | ME662-102         | Replacement Handle for ME662, 665, MES-3329, 3250BC, 2034CLT, 1447C & 1449 Series Valves            |
| Multi-Service ASME Container Vapor Valves | ME662-901K        | Replacement Double Check Fill Valve Kit for ME662   |
|   | ME663             | Replacement Double Check Vapor Return Valve 3/4" MNPT x 1-1/4" ACME                                 |
|   | MES-2030-100KIT   | Fill Valve Repair Kit for MES-PVE2030BC Series Valves   |
|   | MES-3329-13LH-KIT | Replacement Bonnet Kit for MES-PVE3329, 3250BC, 2030BC, 2033CLT, 2034CLT, 1447C & 1449 Series       |
|   | MES-3429-RK       | Dual Bonnet O-Ring Repair Kit for MES-PVE2033CLDB, DLBD, 3250ALG7DB & 3329 Series Valves            |
| O-rings                                   | 568-110-01        | POL O-ring  |
|   | ME220M-02         | Motor Fuel Service Valve ME220M O-ring  |
| POL Adapters                              | ME1002A           | Male Hard Nose POL x 1/4" MNPT-Tailpiece Only   |
|   | ME1002B           | 7/8" POL Nut  |
|   | ME1002BLH         | 1-1/8" POL Nut  |
|   | ME1600AH          | POL Hex Brass Handwheel   |
|   | ME1600AR          | POL Round Brass Handwheel   |
|   | ME1630-02         | Plastic Handwheel for 7/8" POL Nut  |
|   | ME1630-03         | Plastic Handwheel Spring  |



|  | Part No.          | Description   |
|--|-------------------|---|
| Quick Acting Cylinder Hose End Valves  | ME777-129         |   |
| Railcar ESV<br>( <i>Excelsator</i> <sup>™</sup> )<br>High Flow                 | ME983-SRK         | Excelsator High Flow Railcar ESV - Seal Repair Kit - Nitrile                      |
|  | ME983-VRK         | Excelsator High Flow Railcar ESV - Complete Valve Repair Kit - Nitrile            |
|  | ME983-119-150     | Excelsator High Flow Railcar ESV - Replacement Excess Flow Spring 150 GPM (Black) |
|  | ME983-119-250     | Excelsator High Flow Railcar ESV - Replacement Excess Flow Spring 250 GPM (Black) |
|  | ME983-119-500     | Excelsator High Flow Railcar ESV - Replacement Excess Flow Spring 500 GPM (Black) |
|  | ME983-121         | Excelsator High Flow Railcar ESV - Replacement Quick Disconnect Nipple            |
| Regulator Vent Kit<br>( <i>Flex-Vent</i> <sup>™</sup> )                        | ME900-6           | 90° Regulator Vent Assembly w/ Filter   |
|  | ME960-106         | Hose Clamp  |
|  | ME960-107         | Anchor Screw  |
| Service Valves   | ME9101BRK         | MEC Universal Bonnet Replacement Assembly w/o Handwheel                           |
|  | ME9101C1BRK       | MEC 100LB. Service Valve Bonnet Assy. w/ Handwheel                                |
|  | ME9101P5BRK       | MEC Engine Fuel Service Valve Bonnet Assy. w/ Handwheel                           |
|  | ME9101C1-102      | Universal Replacement POL Service Valve Handwheel                                 |
|  | ME9101P5-105      | Universal Replacement Motor Fuel Service Valve Handwheel                          |
|  | ME9101P5-109      | Replacement Handwheel Screw #10-32 - Stainless Steel                              |
|  | ME9101P5-113      | Replacement Engine Fuel Service Valve Name Plate                                  |
|  | ME9101P5-114      | Universal Replacement Bonnet Seal - Nylon   |
| Sight Flow Swing Check Valves  | ME875S-16-05      | ME875S-16 Glass   |
|  | ME875S-16-06      | ME875S-16 Glass Gasket  |
|  | ME875S-16-07      | ME875S-16 Nitrile O-ring Seal   |
|  | ME875S-24-05      | ME875S-24 Glass   |
|  | ME875S-24-06      | ME875S-24 Glass Gasket  |
|  | ME875S-24-07      | ME875S-24 Nitrile O-ring Seal   |
| Toggle Valves<br>(Quick-Acting)  | ME791K            | Non-Locking Series Bonnet Repair Kit  |
|  | ME792K            | Locking Series Bonnet Repair Kit  |
| Transfer Angle Valves  | ME815K            | ME449S and ME449EXS Series Bonnet Assembly  |
| <i>Turbo-Flo LE</i> <sup>™</sup><br>Transfer / Shutoff Valve<br>(ME807, ME808) | ME807CRK          | ME807/ME808 Coupling Repair Kit - Brass   |
|  | ME807SCRK         | ME807/ME808 Coupling Repair Kit - Steel   |
|  | ME807HRK          | ME807/808 Handle Repair Kit - Black   |
|  | ME807VRK          | ME807-16 Valve Repair Kit   |
| <i>Turbo-Flo LE</i> <sup>™</sup><br>Transfer Valve<br>(ME806)                  | ME185             | 3-1/4" ACME Dust Plug with Lanyard  |
|  | ME806CRK          | ME806 Coupling Repair Kit   |
|  | ME806HRK          | ME806 Handle Repair Kit   |
|  | ME807VRK          | ME806 Valve Repair Kit  |
| Type I Filler Couplings  | ME515-3           | 7" Male Hard Nose POL x 1/4" MNPT Stem—Brass                                      |
|  | ME516-1           | 6" Male Hard Nose POL x 1/4" MNPT Stem—Brass                                      |
|  | ME516S-01         | 6" Male Hard Nose POL x 1/4" MNPT Stem—Stainless Steel                            |
|  | ME516-2H          | 1-5/16" F. Acme Extension with Forged Handle                                      |
| POL Filler Couplings   | ME390WR-1         | 6" Soft Nose Male Soft Nose POL with O-ring x 1/4" MNPT Stem—Brass                |
|  | ME390SWR-1        | 6" Soft Nose Male Soft Nose POL with O-ring x 1/4" MNPT Stem—Stainless Steel      |
|  | ME390-2H          | .880 Left Handed Male Thread Extension with Forged Handle                         |
| Vapor Service Valves   | ME663SRK          | Replacement Upper Seal Repair Kit for ME663                                       |
|  | MES-1901S         | MES-3250 Series Valve Shutoff Handwheel .375" ID x 2.00" OD - Aluminum            |
|  | MES-3250-8LH-KIT  | Bonnet Assy Kit for MES-PVE3250 & 2035A Series                                    |
|  | MES-3329-13LH-KIT | Bonnet Assy Kit for MES-PVE3250BC & PVE2030 Series                                |



|                              | Part No.         | Description  |
|------------------------------|------------------|--|
| Vapor Equalizing Valves      | ME663SRK         | Replacement Upper Seal Repair Kit for ME663                          |
| Versa-Fill™<br>Bypass Valves | ME840CK          | 1-1/4" - 2" Classic Poppet with Nitrile O-rings Complete Repair Kit  |
|                              | ME840CVK         | 1-1/4" - 2" Classic Poppet with FKM O-rings Complete Repair Kit      |
|                              | ME840K           | 1-1/4" - 2" Standard Poppet with Nitrile O-rings Complete Repair Kit |
|                              | ME840VK          | 1-1/4" - 2" Standard Poppet with FKM O-rings Complete Repair Kit     |
|                              | ME840-16-108-40  | Bypass Valve Spring 20-40 PSI (Blue)                                 |
|                              | ME840-16-108-70  | Bypass Valve Spring 40-70 PSI (Green)                                |
|                              | ME840-16-108-90  | Bypass Valve Spring 70-90 PSI (Yellow)                               |
|                              | ME840-16-108-125 | Bypass Valve Spring 90-125 PSI (Orange)                              |
|                              | ME840-16-108-150 | Bypass Valve Spring 125-150 PSI (Red)                                |
|                              | ME845-HRK        | Versa-Fill Bypass Handle Repair Kit                                  |
|                              | ME845-PGA        | Versa-Fill Bypass Packing Gland Assembly                             |
|                              | ME845-SRK        | Versa-Fill Bypass Seal Repair Kit                                    |
|                              | ME845-VRK        | Versa-Fill Bypass Complete Valve Repair Kit                          |
| Wheel Chock Bracket          | ME200B-103       | Replacement Rubber Bumper Pad  |
|                              | ME200EXT         | Wheel Chock Block 6" Standoff Extension Kit                          |
| Y-Strainers                  | ME650-03/20      | 1/2" & 3/4" Y-Strainers 20 Mesh Screen                               |
|                              | ME650-03         | 1/2" & 3/4" Y-Strainers 40 Mesh Screen                               |
|                              | ME650-03/80      | 1/2" & 3/4" Y-Strainers 80 Mesh Screen                               |
|                              | ME652-03/20      | 1" Y-Strainer 20 Mesh Screen   |
|                              | ME652-03         | 1" Y-Strainer 40 Mesh Screen   |
|                              | ME652-03/80      | 1" Y-Strainer 80 Mesh Screen   |
|                              | ME653-02/20      | 1-1/4" Y-Strainer 20 Mesh Screen                                     |
|                              | ME653-02         | 1-1/4" Y-Strainer 40 Mesh Screen                                     |
|                              | ME653-02/80      | 1-1/4" Y-Strainer 80 Mesh Screen                                     |
|                              | ME654-03         | 1-1/2" Y-Strainer 40 Mesh Screen                                     |
|                              | ME655-03/20      | 2" Y-Strainer 20 Mesh Screen   |
|                              | ME655-03         | 2" Y-Strainer 40 Mesh Screen   |
|                              | ME655-03/80      | 2" Y-Strainer 80 Mesh Screen   |
|                              | ME656-03         | 3" Y-Strainer 40 Mesh Screen   |
|                              | ME656-03/80      | 3" Y-Strainer 80 Mesh Screen   |
|                              | ME656S-3F-109    | Replacement 3" Filter Flange Gasket                                  |
|                              | ME656S-3F-110    | Replacement 3" Filter Flange O-Ring                                  |
|                              | ME656S-3F-901    | Replacement 3" Flange Y-Strainer Filter                              |
|                              | ME656S-4F-108    | Replacement 4" Filter Flange Gasket                                  |
|                              | ME656S-4F-110    | Replacement 4" Filter Flange O-Ring                                  |
|                              | ME656S-4F-901    | Replacement 4" Flange Y-Strainer Filter                              |
|                              | ME980SK-16       | 2" -300LB Flange Stud & Nut Kit                                      |
|                              | ME980SK-24       | 3" & 4"-300LB Flange Stud & Nut Kit                                  |
|                              | ME980SK-16-103   | 2"-300 LB Flange Spiral Wound Gasket                                 |
|                              | ME904S-3F-027    | 3"-300 LB Flange Spiral Wound Gasket                                 |
|                              | ME904S-4F-027    | 4"-300 LB Flange Spiral Wound Gasket                                 |



# PRODUCTS BY PART NUMBER

|                       |          |                      |         |                        |          |                         |               |
|-----------------------|----------|----------------------|---------|------------------------|----------|-------------------------|---------------|
| 568-110-01.....       | 138      | ME220M-02.....       | 138     | ME418.....             | 196      | ME614 Series.....       | 133           |
| A1132.....            | 203      | ME225.....           | 111     | ME420.....             | 196      | ME623.....              | 133           |
| A1133.....            | 203      | ME226.....           | 111     | ME421.....             | 196      | ME625-34.....           | 134           |
| A1138.....            | 203      | ME227.....           | 111     | ME422.....             | 196      | ME634-24.....           | 130           |
| A1139.....            | 203      | ME228.....           | 111     | ME423.....             | 197      | ME635 Series.....       | 130           |
| A6132.....            | 203      | ME229 Series.....    | 134     | ME424.....             | 196      | ME645G Series.....      | 130           |
| A6133.....            | 203      | ME229-EL.....        | 178     | ME425.....             | 196      | ME646 Series.....       | 130           |
| A6138.....            | 203      | ME233 Series.....    | 133     | ME431 Series.....      | 134      | ME650S-656S Series..... | 126           |
| A6139.....            | 203      | ME239.....           | 135     | ME441 Series.....      | 134-135  | ME662.....              | 170           |
| ME4H.....             | 76       | ME250 Series.....    | 132     | ME442 Series.....      | 133      | ME663.....              | 168           |
| ME10BTK-04.....       | 137      | ME251 Series.....    | 132     | ME449 Series.....      | 141-142  | ME664.....              | 168           |
| ME10BTK-1-01.....     | 208      | ME252-16 Series..... | 132     | ME450.....             | 141-142  | ME664-24.....           | 130           |
| ME23 Series.....      | 202      | ME262 Series.....    | 133     | ME453.....             | 143      | ME665.....              | 170           |
| ME24 Series.....      | 202      | ME270.....           | 133     | ME455.....             | 143      | ME670 Series.....       | 166           |
| ME26C.....            | 202      | ME273 Series.....    | 133     | ME458 Series.....      | 141-143  | ME671D Series.....      | 166           |
| ME27 Series.....      | 204      | ME275 Series.....    | 133     | ME460.....             | 142      | ME672D.....             | 166           |
| ME50ECO-2.....        | 206      | ME277 Series.....    | 133     | ME461.....             | 141      | ME673 Series.....       | 167           |
| ME50P Series.....     | 205      | ME284.....           | 193     | ME462 Series.....      | 141-142  | ME673DEX-6SP.....       | 165           |
| ME60-2.....           | 205      | ME285.....           | 193     | ME474.....             | 197      | ME680-8.....            | 127           |
| ME60P Series.....     | 205      | ME286.....           | 193     | ME475 Series.....      | 197      | ME690 Series.....       | 199           |
| ME100.....            | 130      | ME287.....           | 193     | ME477.....             | 197      | ME691 Series.....       | 88            |
| ME101.....            | 130      | ME295 Series.....    | 208     | ME480 Series.....      | 199      | ME693 Series.....       | 88            |
| ME106 Series.....     | 134      | ME296 Series.....    | 208     | ME481.....             | 197, 199 | ME707.....              | 111           |
| ME108 Series.....     | 134      | ME297 Series.....    | 208     | ME483.....             | 198      | ME708.....              | 111           |
| ME109 Series.....     | 134      | ME298 Series.....    | 208     | ME484.....             | 198      | ME709.....              | 111, 127, 178 |
| ME110 Series.....     | 130      | ME299 Series.....    | 208     | ME485.....             | 198      | ME710.....              | 112           |
| ME111 Series.....     | 130      | ME301.....           | 193     | ME487.....             | 198      | ME777 Series.....       | 179           |
| ME112 Series.....     | 130      | ME302.....           | 193     | ME488.....             | 198      | ME778 Series.....       | 179           |
| ME120 Series.....     | 130      | ME303.....           | 193     | ME491.....             | 198      | ME779 Series.....       | 179           |
| ME121S Series.....    | 130      | ME304.....           | 193     | ME492.....             | 198      | ME790.....              | 177           |
| ME130 Series.....     | 130      | ME305.....           | 193     | ME493.....             | 198      | ME790SN.....            | 177           |
| ME134WR/ME134SWR..... | 54       | ME306.....           | 202     | ME494.....             | 198      | ME790L.....             | 178           |
| ME135.....            | 54       | ME307.....           | 202     | ME496.....             | 198      | ME791 Series.....       | 182           |
| ME140.....            | 130      | ME308.....           | 202     | ME497 Series.....      | 197      | ME792 Series.....       | 182           |
| ME141 Series.....     | 130      | ME309-1.....         | 202     | ME498 Series.....      | 132-133  | ME796.....              | 180           |
| ME150 Series.....     | 130      | ME312-5MV.....       | 191     | ME502 Series.....      | 132-133  | ME800 Series.....       | 74            |
| ME151 Series.....     | 130      | ME318.....           | 192     | ME503-16 Series.....   | 132-133  | ME806-16 Series.....    | 53            |
| ME160 Series.....     | 130      | ME319.....           | 192     | ME503JT-16 Series..... | 131      | ME807-16 Series.....    | 53-54         |
| ME178 Series.....     | 135      | ME322.....           | 192     | ME503PIB.....          | 77       | ME807PIB.....           | 54-55, 77     |
| ME179 Series.....     | 135      | ME345.....           | 192     | ME504-24.....          | 133      | ME808-16 Series.....    | 53, 55        |
| ME180 Series.....     | 135      | ME348.....           | 192     | ME508-24 Series.....   | 132      | ME808PIB.....           | 77            |
| ME181 Series.....     | 135      | ME350 Series.....    | 191     | ME515.....             | 180      | ME810 Series.....       | 78            |
| ME192.....            | 132      | ME351.....           | 193     | ME516 Series.....      | 180      | ME810FSV Series.....    | 122           |
| ME193.....            | 132      | ME352.....           | 193     | ME517 Series.....      | 188      | ME813 Series.....       | 59-60         |
| ME200 Series.....     | 136      | ME353 Series.....    | 193     | ME518 Series.....      | 188      | ME815 Series.....       | 58            |
| ME200PIB.....         | 77       | ME354 Series.....    | 193     | ME519 Series.....      | 188      | ME815-16LHK.....        | 63            |
| ME200PIBK.....        | 77       | ME355 Series.....    | 193     | ME520S-8.....          | 133      | ME815IBC-16.....        | 61            |
| ME202 Series.....     | 138      | ME356 Series.....    | 193     | ME521S-4.....          | 133      | ME815P-16.....          | 61            |
| ME204.....            | 127, 138 | ME357.....           | 193     | ME524-24.....          | 133      | ME818 Series.....       | 59-60, 62     |
| ME205 Series.....     | 112      | ME388.....           | 181     | ME530 Series.....      | 194      | ME819 Series.....       | 59-60, 62     |
| ME205-013.....        | 138      | ME390 Series.....    | 181     | ME540.....             | 75       | ME820 Series.....       | 78            |
| ME206.....            | 112      | ME392.....           | 181     | ME551.....             | 114      | ME820FSV Series.....    | 122           |
| ME206-09.....         | 138      | ME392P.....          | 188     | ME552.....             | 114      | ME821 Series.....       | 78            |
| ME207.....            | 112      | ME393 Series.....    | 180     | ME568.....             | 181      | ME822 Series.....       | 59, 62        |
| ME207SF.....          | 112      | ME393-1.....         | 190     | ME569.....             | 180      | ME823 Series.....       | 59, 62        |
| ME208SF.....          | 112      | ME393-2.....         | 181     | ME570.....             | 79       | ME824 Series.....       | 58            |
| ME209 Series.....     | 132      | ME393EX Series.....  | 190     | ME571 Series.....      | 79       | ME824IBC-16.....        | 61            |
| ME210.....            | 132      | ME394.....           | 180-181 | ME572 Series.....      | 79       | ME824P-16.....          | 61            |
| ME211.....            | 132      | ME398.....           | 190     | ME574 Series.....      | 79       | ME825 Series.....       | 58            |
| ME212.....            | 132      | ME399.....           | 190     | ME578 Series.....      | 79       | ME825-3F.....           | 64            |
| ME213 Series.....     | 132      | ME412.....           | 196     | ME600 Series.....      | 167      | ME825-4F.....           | 64            |
| ME214 Series.....     | 132      | ME413.....           | 196     | ME601 Series.....      | 168      | ME825IBC-16.....        | 61            |
| ME215 Series.....     | 133      | ME414.....           | 196     | ME602-8.....           | 175      | ME825P-16.....          | 61            |
| ME216 Series.....     | 133      | ME415.....           | 196     | ME605-34.....          | 134      | ME825P-16-4 Series..... | 63            |
| ME217 Series.....     | 133      | ME415-01.....        | 201     | ME611 Series.....      | 133      | ME829.....              | 58, 61, 64    |
| ME217PIB.....         | 77       | ME416.....           | 196     | ME612 Series.....      | 133      | ME830 Series.....       | 143           |
| ME220 Series.....     | 177-178  | ME417.....           | 198     | ME613.....             | 133      | ME831 Series.....       | 139           |

|                           |           |                        |             |                         |            |                         |          |
|---------------------------|-----------|------------------------|-------------|-------------------------|------------|-------------------------|----------|
| ME832.....                | 139       | ME991-24 Series.....   | 97          | ME7323.....             | 204        | MEGR-1252D Series.....  | 18       |
| ME833.....                | 139       | ME992-10 Series.....   | 93          | ME7324.....             | 204        | MEGR-1252H Series.....  | 14       |
| ME834.....                | 139       | ME992-12 Series.....   | 94          | ME7325.....             | 204        | MEGR-1289H Series.....  | 49       |
| ME840 Series.....         | 67, 72-73 | ME992-16 Series.....   | 98          | ME7326.....             | 204        | MEGR-1290H Series.....  | 49       |
| ME841 Series.....         | 67, 72-73 | ME992-24 Series.....   | 98          | ME7327.....             | 204        | MEGR-1584 Series.....   | 44       |
| ME842 Series.....         | 67, 81    | ME992S-2F Series.....  | 99          | ME7329.....             | 204        | MEGR-1586 Series.....   | 44       |
| ME843 Series.....         | 67, 81    | ME992S-3F Series.....  | 99          | ME7330.....             | 204        | MEGR-1622 Series.....   | 20, 21   |
| ME845 Series.....         | 70-71     | ME993S-16 Series.....  | 100         | ME7331.....             | 204        | MEGR-1622C Series.....  | 23       |
| ME846 Series.....         | 70-71     | ME994S-2F Series.....  | 101         | ME7332.....             | 204        | MEGR-1622D Series.....  | 18       |
| ME850SS Series.....       | 76        | ME994S-3F Series.....  | 104         | ME7333.....             | 204        | MEGR-1622E Series.....  | 25       |
| ME860S Series.....        | 129       | ME1000 Series.....     | 90          | ME8346.....             | 178        | MEGR-1622ED Series..... | 25       |
| ME861S Series.....        | 129       | ME1328.....            | 205         | ME9101C Series.....     | 169        | MEGR-1622H Series.....  | 15-16    |
| ME866-868 Series.....     | 56        | ME1331.....            | 205         | ME9101D Series.....     | 169        | MEGR-1622HT Series..... | 16       |
| ME868MIB.....             | 56        | ME1332.....            | 205         | ME9101H Series.....     | 175        | MEGR-1627 Series.....   | 46       |
| ME868PIB.....             | 56, 76-77 | ME1629.....            | 192         | ME9101P Series.....     | 175        | MEGR-1630.....          | 46       |
| ME869 Series.....         | 89        | ME1638.....            | 192         | ME-AD-AB.....           | 206        | MEGR-1632 Series.....   | 29       |
| ME870 Series.....         | 86        | ME1641 Series.....     | 192         | ME-AD-BA.....           | 206        | MEGR-1632E Series.....  | 33       |
| ME870-10-1.....           | 128       | ME1645.....            | 202         | MEF41-6.....            | 201        | MEGR-1632T Series.....  | 32       |
| ME870-16-01.....          | 128       | ME1645-78N.....        | 202         | MEF42 Series.....       | 200        | MEGR-1642-DFF.....      | 22       |
| ME870-6-1.....            | 128       | ME1650 Series.....     | 202         | MEF44 Series.....       | 201        | MEGR-1642D-DFF.....     | 18       |
| ME870SW-16.....           | 88        | ME1651.....            | 202         | MEF46 Series.....       | 200        | MEGR-1652 Series.....   | 20       |
| ME872 Series.....         | 86        | ME1653 Series.....     | 192         | MEF48 Series.....       | 200        | MEGR-1652D Series.....  | 18       |
| ME873S Series.....        | 85        | ME1654 Series.....     | 192         | MEF49 Series.....       | 201        | MEGR-1652E-DFH.....     | 26       |
| ME874S-16.....            | 124       | ME1655 Series.....     | 192         | MEF54 Series.....       | 200        | MEGR-1652ED-DFH.....    | 25       |
| ME875S Series.....        | 125       | ME1656 Series.....     | 192         | MEF55 Series.....       | 201        | MEGR-1912 Series.....   | 40       |
| ME880 Series.....         | 82        | ME1657.....            | 192         | MEF216 Series.....      | 201        | MEGR-6120 Series.....   | 42       |
| ME882S Series.....        | 82        | ME1660 Series.....     | 183         | ME-GA-30N.....          | 206        | MEGR-6121 Series.....   | 42       |
| ME883S Series.....        | 81        | ME1661 Series.....     | 183         | ME-GA-300N.....         | 206        | MEGR-11301F.....        | 45       |
| ME890PIB.....             | 77        | ME1662 Series.....     | 183         | ME-GA35WCN.....         | 206        | MEGR-CS1200 Series..... | 47       |
| ME902S Series.....        | 155-156   | ME1663 Series.....     | 183         | ME-GA5.....             | 206        | MEGR-RVB.....           | 37-38    |
| ME903S Series.....        | 154-156   | ME1664 Series.....     | 183         | ME-GA5N.....            | 206        | MEGR-S1202 Series.....  | 47       |
| ME904S Series.....        | 154-156   | ME1665 Series.....     | 183         | ME-GMC4 Series.....     | 191        | ME-HSA.....             | 207      |
| ME904SK.....              | 154       | ME1669 Series.....     | 183-184     | ME-GMC6.....            | 191        | MEH25 Series.....       | 142,164  |
| ME930 Series.....         | 147-150   | ME1679 Series.....     | 183         | ME-GMCL4.....           | 191        | MEH50 Series.....       | 164      |
| ME931.....                | 147       | ME1680 Series.....     | 183         | MEGR-1HSRL Series.....  | 47         | MEH75 Series.....       | 164      |
| ME932.....                | 147       | ME1680-12B Series..... | 184         | MEGR-100C.....          | 24         | MEH225 Series.....      | 142, 164 |
| ME940 Series.....         | 147-150   | ME1683.....            | 192         | MEGR-130 Series.....    | 41         | MEH501 Series.....      | 164      |
| ME951 Series.....         | 189       | ME1684.....            | 192         | MEGR-130-50.....        | 41, 111    | M-HSB.....              | 207      |
| ME952 Series.....         | 189       | ME1684-"X".....        | 183         | MEGR-164 Series.....    | 43         | MEH502.....             | 162      |
| ME952-07.....             | 188       | ME1687.....            | 202         | MEGR-175CS Series.....  | 36         | MEH503.....             | 162      |
| ME960 Series.....         | 31        | ME1689.....            | 202         | MEGR-198H Series.....   | 45         | MEJ2.5GB.....           | 137      |
| ME970P.....               | 193       | ME1689-"X" Series..... | 183         | MEGR-199 Series.....    | 50         | MEJ400 Series.....      | 131,140  |
| ME980 Series.....         | 119       | ME1689-5B90.....       | 184         | MEGR-218.....           | 39         | MEJ401Series.....       | 140      |
| ME980-905.....            | 113       | ME1689-6B90.....       | 184         | MEGR-230 Series.....    | 39         | MEJ402S.....            | 131,140  |
| ME980-906-"X".....        | 113       | ME1690 Series.....     | 192         | MEGR-231.....           | 39         | MEJ402S-120.....        | 140      |
| ME980C Series.....        | 119       | ME1691 Series.....     | 193         | MEGR-253 Series.....    | 37         | MEJ410 Series.....      | 140      |
| ME980SAR-4DFM.....        | 120       | ME1692.....            | 192         | MEGR-291 Series.....    | 38         | MEJ415 Series.....      | 143      |
| ME980SAR-6DFM.....        | 120       | ME1695 Series.....     | 201         | MEGR-295 Series.....    | 38         | MEJ500.....             | 137      |
| ME981 Series.....         | 123       | ME1699.....            | 193         | MEGR-298 Series.....    | 38         | MEJ501.....             | 137, 206 |
| ME982 Series.....         | 123       | ME1700 Series.....     | 195         | MEGR-300 Series.....    | 35         | MEJ502.....             | 137      |
| ME983-16 Series.....      | 121       | ME1701 Series.....     | 195         | MEGR-350 Series.....    | 41         | MEJ503.....             | 137      |
| ME990-10 Series.....      | 91        | ME1702 Series.....     | 195         | MEGR-351.....           | 41         | MEJ504.....             | 137      |
| ME990-10-902.....         | 113       | ME1704B.....           | 195         | MEGR-360.....           | 41         | MEJ505.....             | 137      |
| ME990-16 Series.....      | 95        | ME1705A.....           | 195         | MEGR-861.....           | 35, 38     | MEJ510.....             | 137      |
| ME990-24 Series.....      | 95        | ME2130.....            | 28,29,32,33 | MEGR-862.....           | 35, 37, 38 | MEJ511.....             | 137      |
| ME990-3F Series.....      | 102       | ME2131.....            | 201         | MEGR-900.....           | 35, 37, 38 | MEJ512.....             | 137      |
| ME990-4F Series.....      | 106       | ME2132.....            | 201         | MEGR-1122H Series.....  | 13         | MEJ513.....             | 137      |
| ME990S-2DFM Series.....   | 96        | ME3162 Series.....     | 128         | MEGR-1222H Series.....  | 13         | MEJ516.....             | 137      |
| ME990S-2F-16 Series.....  | 96        | ME3194C.....           | 89          | MEGR-1133 Series.....   | 48         | MEJ520.....             | 137      |
| ME990S-3DF.....           | 103       | ME3197C.....           | 89          | MEGR-1222 Series.....   | 19         | MEJ524.....             | 137      |
| ME990S-3DFM Series.....   | 103       | ME3400 Series.....     | 87          | MEGR-1222D Series.....  | 18         | MEJ526.....             | 137,143  |
| ME990S-3DF0 Series.....   | 105       | ME3500 Series.....     | 83          | MEGR-1222HT Series..... | 16         | MEJ542.....             | 137,143  |
| ME990S-3F Series.....     | 102       | ME3600 Series.....     | 84          | MEGR-1232 Series.....   | 28         | MEJ552.....             | 137      |
| ME990SAR-4DFM Series..... | 107       | ME4231-4857.....       | 203         | MEGR-1232-DEMO.....     | 33         | MEJ580.....             | 137      |
| ME990SAR-6DFM Series..... | 107       | ME5231-ME5835.....     | 203         | MEGR-1232E Series.....  | 32         | MEJ595.....             | 208      |
| ME991-10 Series.....      | 92        | ME5930 Series.....     | 192         | MEGR-1232T Series.....  | 31         | MEJ600.....             | 204      |
| ME991-16 Series.....      | 97        | ME5931 Series.....     | 192         | MEGR-1252 Series.....   | 19         | MEJ600-02.....          | 137, 206 |

# PRODUCTS BY PART NUMBER

|                       |          |                         |          |                           |              |
|-----------------------|----------|-------------------------|----------|---------------------------|--------------|
| MEJ601 Series.....    | 204      | MEP873.....             | 81       | ME-SKVA.....              | 207          |
| MEJ602.....           | 208      | MEP889 Series.....      | 116      | ME-SKVB.....              | 207          |
| MEJ602H.....          | 140,164  | MEP930WG.....           | 150      | MES-PVE10ARF.....         | 140          |
| MEJ603HP.....         | 208      | MEP960.....             | 31       | MES-PVE2030BC Series..... | 173          |
| MEJ603HP-01.....      | 137      | MEP980PN-100.....       | 115      | MES-PVE2035AT Series..... | 174          |
| MEJ603LP.....         | 208      | MEP990-24.....          | 113      | MES-PVE2098 Series.....   | 176          |
| MEJ603LP-01.....      | 137      | MEP990-2DFM & 3DFM..... | 117      | MES-PVE3250 Series.....   | 171-172      |
| MEJ604.....           | 208      | MEP990-4DFM & 6DFM..... | 117      | ME-SQTG-4A.....           | 206          |
| MEJ606.....           | 140      | MEP990-4DFM/3DFM.....   | 118, 154 | ME-SQTG-4B.....           | 206          |
| MEJ607-02.....        | 208      | MEP990-4F.....          | 113      | ME-TGA.....               | 207          |
| MEJ608B-02.....       | 208      | MEP994-2F.....          | 101      | ME-TGB.....               | 207          |
| MEJ610 Series.....    | 205      | MEP995S Series.....     | 65       | MESTF33.....              | 201          |
| MEJ700.....           | 137      | MEP996S Series.....     | 65       | MET443.....               | 178          |
| MEJ701.....           | 137      | MEP997S-24/16.....      | 66       | MET444.....               | 178          |
| MEJ702.....           | 137      | MEP998.....             | 69       | MET445.....               | 178          |
| MEJ703.....           | 137      | MEP999S Series.....     | 65       | ME-T9-444.....            | 195          |
| ME-KVA.....           | 207      | MEP999SPE-16.....       | 66       | METL051.....              | 205          |
| ME-KVB.....           | 207      | MEP1600 Series.....     | 24       | METL052.....              | 205          |
| ME-LD Series.....     | 204      | MEP1632.....            | 29       | ME-US4 Series.....        | 200          |
| ME-NS4 Series.....    | 200      | MEP-GMC1.....           | 139      | ME-VA1.....               | 207-208      |
| MEP2 Series.....      | 201      | MEP-RDC1.....           | 139      | ME-VA2.....               | 207-208      |
| MEP082.....           | 136      | MEPS-433-45A.....       | 162      | ME-VB1.....               | 207          |
| MEP100.....           | 194      | MEPS-443-45A.....       | 162      | ME-VB2.....               | 207          |
| MEP104-24.....        | 128      | MEPS-445-21.....        | 159      | MEV25 Series.....         | 157          |
| MEP104-95.....        | 139      | MEPS-453-45A.....       | 162      | MEV50 Series.....         | 157          |
| MEP105.....           | 56       | MER401 Series.....      | 185      | MEV75 Series.....         | 157          |
| MEP120 Series.....    | 135      | MER403 Series.....      | 185      | MEV75FIR.....             | 159          |
| MEP121.....           | 181      | MER404 Series.....      | 185      | MEV125 Series.....        | 155-156, 158 |
| MEP122.....           | 181      | MER405 Series.....      | 185      | MEV200FIR Series.....     | 160          |
| MEP123.....           | 155      | MER406AR Series.....    | 185      | MEV200SIR Series.....     | 163          |
| MEP125.....           | 175      | MER407 Series.....      | 185      | MEV250 Series.....        | 154, 158     |
| MEP126.....           | 176      | MER408 Series.....      | 185      | MEV250-013.....           | 164          |
| MEP123.....           | 155, 158 | MER409 Series.....      | 185      | MEV300FIR Series.....     | 160          |
| MEP147.....           | 134      | MER410 Series.....      | 185      | MEV300FIR-3F Series.....  | 161          |
| MEP148.....           | 134-135  | MER412 Series.....      | 185      | MEVS-PVE431 Series.....   | 157          |
| MEP167.....           | 134-135  | MER413 Series.....      | 185      | MEVS-PVE445 Series.....   | 159          |
| MEP168.....           | 134-135  | MER414 Series.....      | 185      | MEVS-UVE433 Series.....   | 162          |
| MEP170.....           | 148, 158 | MER421 Series.....      | 185      | MEVS-UVE443 Series.....   | 162          |
| MEP173.....           | 157      | MER422 Series.....      | 185      | MEVS-UVE445 Series.....   | 159          |
| MEP174.....           | 157      | MER423 Series.....      | 185      | MEVS-UVE453 Series.....   | 162          |
| MEP175C.....          | 159      | MER425 Series.....      | 185      | MEW1-MEW6.....            | 138          |
| MEP175P.....          | 159      | MER425H Series.....     | 186      |                           |              |
| MEP175-45.....        | 159      | MER425HSS Series.....   | 186      |                           |              |
| MEP175-90.....        | 159      | MER425SS Series.....    | 186      |                           |              |
| MEP178 Series.....    | 155, 158 | MER426 Series.....      | 185      |                           |              |
| MEP183.....           | 135      | MER426H Series.....     | 186      |                           |              |
| MEP183-102.....       | 81       | MER427 Series.....      | 185      |                           |              |
| MEP200FIR.....        | 88, 160  | MER428 Series.....      | 185      |                           |              |
| MEP250.....           | 158, 160 | MER429 Series.....      | 185      |                           |              |
| MEP300FIR.....        | 88, 160  | MER432 Series.....      | 208      |                           |              |
| MEP456A.....          | 195      | MER434 Series.....      | 185      |                           |              |
| MEP502.....           | 133      | MER470-MER473.....      | 187      |                           |              |
| MEP503.....           | 133      | MER610 Series.....      | 184      |                           |              |
| MEP650.....           | 113      | MER611 Series.....      | 184      |                           |              |
| MEP651.....           | 113      | MER613 Series.....      | 184      |                           |              |
| MEP700.....           | 182      | ME-RVSDC-4.....         | 191      |                           |              |
| MEP801 Series.....    | 75,77    | ME-QTG127A.....         | 206      |                           |              |
| MEP802 Series.....    | 75,77    | ME-QTG128B.....         | 206      |                           |              |
| MEP803PCK Series..... | 77       | ME-QTG16A.....          | 206      |                           |              |
| MEP804 Series.....    | 75,77    | ME-QTG16B.....          | 206      |                           |              |
| MEP840 Series.....    | 67       | MES-FG1280 Series.....  | 145      |                           |              |
| MEP840H.....          | 68       | MES-FG1281 Series.....  | 146      |                           |              |
| MEP840HC Series.....  | 64       | MES-FG1284-001U.....    | 144      |                           |              |
| MEP841 Series.....    | 67       | MES-FG2184-001U.....    | 144      |                           |              |
| MEP841H.....          | 68       | MES-FG2281 Series.....  | 145      |                           |              |
| MEP841H-24/16.....    | 69       | MES-FG2284-001U.....    | 144      |                           |              |
| MEP841HC Series.....  | 68       | MES-FG3981 Series.....  | 144      |                           |              |

# PRODUCTS BY SECTION

 EXCELA-FLO REGULATORS

 TRUCK & PLANT EQUIPMENT

 ACCU-MAX FLOAT GAUGES

 PRESSURE RELIEF VALVES & MANIFOLDS

 DOT/ASME CONTAINER VALVES

 DISPENSING VALVES & ADAPTERS

 PIGTAILS, HOGTAILS & HOSE ASSEMBLIES

 FITTINGS & ACCESSORIES

 REPLACEMENT PARTS & REPAIR KITS

## A

Acme Adapters & Reducers  
Acme Caps, Flanges & Plugs  
Acme Spanner Wrenches  
Actuators & Accessories

## B

Back Check Valves  
Back Check Fill Valves (Single and Double)  
Back Pressure Regulator Relief Valves  
Breakaway Couplings & Accessories  
Bulkheads  
Bypass Valves

## C

Camping Elbows, Fittings & Tees  
Camping Kits & Adapters  
Carburetion Equipment  
CGA 555 Fittings  
Combination Valves  
Companion Flanges  
Container Fill Valves  
Container Service Valves  
Cross-Over Self Load Intake Adapter  
Cylinder Collars  
Cylinder Valve Wrenches (OPD/QCC & POL)

## D

Dielectric Pigtailes  
Dielectric Unions  
Dispensing Filter (for LPG/NH3)  
Dispensing Valves (Quick Acting)  
Double Back Check Valves  
Double Check Filler Valves

## E

Engine Fuel Valves & Accessories  
Emergency Shutoff Valves & Accessories  
Equalizing Valves (Vapor)  
Excess Flow Adapters  
Excess Flow Valves (Container)

## F

Filler Couplings  
Fill Check Adapters (Hose End)  
Ferrules & Menders (Hose)  
Fixed Maximum Liquid Level Gauges  
Flange Unions  
Flange Adapters  
Flare Fittings  
Flex-Vent Regulator Vent Kit  
Float Gauges & Accessories  
Flow Indicating Check Valve  
Four Bolt Flange Union  
Fuse Plugs

## G

Gas Box (Convenience Outlet)  
Globe & Angle Valves  
Grounding Stud

## H

High Pressure Gas Connections  
High Pressure Test Blocks & Accessories  
Hogtails (Copper)  
Hose Barbs  
Hoses (Thermoplastic)  
Hose End Delivery Valves & Accessories  
Hose End Valve Holster  
Hose End Swivel Connectors  
Hose Clamp Couplings  
Hose Reel Control Switch Covers

## I

Internal Valves & Accessories

## L

Leak Detector  
Leak Check and Regulator Testing Kits  
LED Light Strip  
Liquid Transfer Valves & Adapters  
Locking Handwheel Kit  
Low Emission Products  
Low Pressure Test Blocks, Kits & Accessories

## M

Manifolds (Relief Valves)  
Methanol Injector  
Multi-Purpose Valves  
Multi-Service Valves

## N

Needle Valves

## P

Pigtailes (Copper)  
Pipeaway Adapters  
Pipe Thread Adapters  
POL Filler Couplings  
POL Fittings  
POL Thread Clean Out Tool  
Pressure Gauges & Accessories  
Pressure Test Kits, Blocks & Accessories  
Pump Auxiliary Suction Intake Flange Adapters

## Q

Quick Acting Hose End Valves (Low Emission)

Quick Connect Filler Coupling  
Quick Disconnect Couplings

## R

Railcar ESV  
Regulators & Accessories  
Relief Valves & Accessories (Hydrostatic)  
Relief Valves & Accessories (Pressure)

## S

Safe-T-Locks  
Seal Gasket Kit  
Serviceman's Friend  
Service Valves  
Sight Flow Valves  
Single Check Remote Fill Valve  
Smart Interlock Technologies & Accessories  
Socket Weld Bodies  
Strainers  
Stainless Steel Braided Pigtailes  
Swivel Connectors (Hose End)

## T

Tank Filler Valves  
Tee Check & Block Manifolds  
Thermometers (Container)  
Toggle Valves (Quick Acting)  
Turbo-Flo LE Excelsa-Flange Dry Break Transfer Valves  
Turbo-Flo LE Transfer System & Accessories  
Turbo-Flo LE Shutoff Valve & Accessories  
Type I (QCC) Filler Couplings & Adapters  
Type I (QCC) Connectors

## U

Underground Tank Cluster Manifold  
Underground Tank Cluster Removal Tool  
Utility Bracket

## V

Vapor Couplings  
Vapor Equalizing Valves  
Vent Valves

## W

Wheel Chocks & Accessories  
Withdrawal Valves

## Y

Y-Strainers

# Warranty Information

## WARNING

Marshall Excelsior's products are mechanical devices made of materials such as rubber and metal, and are subject to wear, the effects of contaminants, corrosion, and aging, and these devices will eventually become inoperative. Regular inspection and maintenance is essential. Marshall Excelsior's products have a long record of quality and service, and therefore LP-Gas dealers may forget hazards that can arise from using aging devices that have outlived their safe service life. The safe service life of these products will be affected by the environment and the conditions of their use. The LP-Gas dealer knows better than anyone what this environment and the conditions of use are.

There are developing trends in state legislation and proposed national legislation making the owner of products responsible for replacing products before they outlive their safe service life. LP-Gas dealers should be aware of such legislation as it affects them.

All Marshall Excelsior products must be installed, inspected and maintained by a trained and experienced professional adhering to all installation instructions, product and safety warnings, local, state, and federal regulations, codes and standards and any other standards set by, but not limited to, NFPA, DOT or ANSI.

LP-Gas is a highly explosive and flammable gas that should never be vented near a possible ignition source.

## LIMITED WARRANTY

THIS WARRANTY for Marshall Excelsior manufactured products is provided by Marshall Excelsior, Inc., 1506 George Brown Drive, Marshall, MI 49068. Marshall Excelsior, unless otherwise specified in writing, warrants to the original buyer that for a period of five (5) years from the date of manufacture its products and repair kits will be free from defects in material and workmanship under normal service and use. This warranty covers manufacturing defects only, and does not cover defects and product non-compliance due to, misuse, alteration, neglect, accident, fire, or other external causes, alterations, or repairs. This limited warranty also does not cover normal wear and tear. During this warranty period, if a defect arises in the product, and you follow the instructions for returning the product, Marshall Excelsior will, at its option, to the extent permitted by law, either (i) repair the product using either new or refurbished parts, (ii) replace the product with a new or refurbished product that is equivalent to the product that is to be replaced, or (iii) refund to you all or part of the purchase price of the product. This limited warranty applies to the extent permitted by law, to any repair, replacement part or replacement device for the remainder of the original warranty period or for ninety (90) days whichever period is longer. All replaced parts and products for which a refund is given shall become the property of Marshall Excelsior. This is the only warranty or representation made by Marshall Excelsior, and the sole basis for liability respecting quality, performance, defects, repair, delivery, and replacement of products and repair kits. The foregoing shall constitute Marshall Excelsior's sole liability.

Marshall Excelsior does not warrant any product or part that has been altered, accidentally damaged, disassembled, modified, misused, neglected, not properly maintained or installed. Marshall Excelsior does not warrant cosmetic issues including but not limited to dents, scratches, product discoloration, color fading or any other imperfection that does not affect the functionality of the product. Marshall Excelsior does not warranty any product or part not installed according to Marshall Excelsior's installation instructions or installed in violation of any regulation or warning by state, local, or federal regulators, or in violation of any standard

or code set by, but not limited to, NFPA, DOT or ANSI requirements. The foregoing shall constitute Marshall Excelsior's sole liability to distributors, vendees and end users.

## K&A PRODUCT LIMITED WARRANTY

Marshall Excelsior warrants K&A products and repair kits to the original buyer to be free of defects in material and workmanship under normal service and use for one year from manufactured date

## LIMITATIONS

TO THE EXTENT PERMITTED BY LAW, THE WARRANTY AND REMEDIES SET FORTH ABOVE ARE EXCLUSIVE AND IN LIEU OF ALL OTHER WARRANTIES AND REMEDIES, AND MARSHALL EXCELSIOR SPECIFICALLY DISCLAIMS ALL STATUTORY OR IMPLIED WARRANTIES, INCLUDING, BUT NOT LIMITED TO, WARRANTIES OF MERCHANTABILITY, FITNESS FOR A PARTICULAR PURPOSE AND AGAINST HIDDEN OR LATENT DEFECTS. IF MARSHALL EXCELSIOR CANNOT LAWFULLY DISCLAIM STATUTORY OR IMPLIED WARRANTIES, THEN TO THE EXTENT PERMITTED BY LAW, ALL SUCH WARRANTIES SHALL BE LIMITED IN DURATION TO THE DURATION OF THIS EXPRESS LIMITED WARRANTY AND TO REPAIR OR REPLACEMENT AND SERVICE.

MARSHALL EXCELSIOR IS NOT RESPONSIBLE FOR DIRECT, SPECIAL, INCIDENTAL OR CONSEQUENTIAL DAMAGES RESULTING FROM ANY BREACH OF WARRANTY OR UNDER ANY OTHER LEGAL THEORY.

MARSHALL EXCELSIOR'S LIABILITY (EXCEPT AS TO TITLE) ARISING OUT OF THE SALE, USE OR OPERATION OF PRODUCTS OR REPAIR KITS, WHETHER ON CLAIMS FOR BREACH OF WARRANTY, CONTRACT, NEGLIGENCE OR OTHERWISE (INCLUDING CLAIMS OF CONSEQUENTIAL OR INCIDENTAL DAMAGES) SHALL NOT IN ANY EVENT EXCEED THE COST OF FURNISHING OR REPLACEMENT OF THE DEFECTIVE PRODUCT OR REPAIR KIT.

## WARRANTY CLAIMS AND NOTICE

Warranty claims shall be made in writing to Marshall Excelsior's Home Office at 1506 George Brown Drive, Marshall, Michigan 49068 by the distributor, vendee or end user within twenty (20) days of discovery of the defect and the product must be postmarked and shipped F.O.B. origin to Marshall Excelsior's Home Office within thirty (30) days of the discovery of the defect. Marshall Excelsior will not accept any products or repair kits that does not have a Return Material Authorization (RMA) number from the Home Office in Marshall, Michigan. After Marshall Excelsior has inspected the product and deemed the product to be defective, at its discretion, Marshall Excelsior will repair, replace or refund the purchase price of the defective product or repair kit. If the buyer does not comply with the above stated requirements the buyer will waive unconditionally and absolutely any and all claims arising out of the alleged defect.

## COMPLIANCE

Marshall Excelsior manufactures all of our products to the highest industry standards. All of our products meet or exceed the requirements of the Compressed Gas Association (CGA), the National Fire Protection Association (NFPA), American National Standards Institute (ANSI), American Society of Mechanical Engineers (ASME) or Underwriters Laboratories, Inc. (UL) where indicated.

## PRODUCT CHANGES

Marshall Excelsior reserves the right to change product specifications at any time. We are constantly evaluating our products and incorporating engineering advances to ensure our products perform and comply with changes in market conditions, government mandates, and code changes. Marshall Excelsior shall not be required to modify any equipment already sold or in service.

## FILTERS

Marshall Excelsior develops products to be used in a debris, dirt and contamination free system. Installing an in-line filter may be necessary in a system that contains unclean product or when the system contains debris, dirt, scale, rust or other contaminants.

## PRODUCT AGE

Marshall Excelsior products are mechanical devices that are subject to wear, contaminants, corrosion, and aging of components made of materials such as rubber and metal. Over time these devices will eventually become inoperative. The safe service life of these products will reflect the environment and conditions of use that they are subjected to. Regular inspection and maintenance is essential. Marshall Excelsior products have a long record of quality and service, so LP-Gas dealers may forget hazards that can arise from using aging devices that have outlived their safe service life. The length of a device's life is determined by the environment in which it is used, and the LP-Gas dealer knows better than anyone about this environment.

There are developing trends in state legislation and proposed national legislation making the owner of products responsible for replacing products before they outlive their safe service life. LP-Gas dealers should be aware of such legislation as it affects them.

To determine the product's age, check the product for a date code consisting of a series of letters and numbers.

|             |              |               |
|-------------|--------------|---------------|
| A = January | B = February | C = March     |
| D = April   | E = May      | F = June      |
| G = July    | H = August   | I = September |
| J = October | K = November | L = December  |

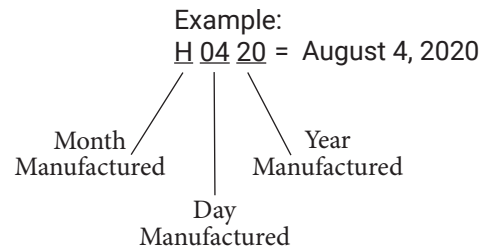

NOTE: Internal relief valves feature a different date code system.

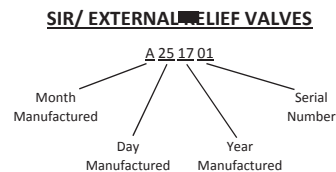
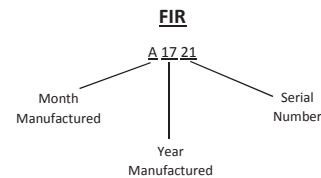



# NOTES

---



A series of horizontal lines for taking notes, overlaid on a blurred background image of a white tanker truck. The truck is viewed from the driver's perspective, showing the steering wheel and the front of the vehicle. The tank has some red markings on it. The background is a bright, outdoor setting with some greenery and a blue structure visible in the distance.



# innovation made simple

## MARSHALL EXCELSIOR COMPANY

1506 GEORGE BROWN DRIVE . MARSHALL, MI  
UNITED STATES . 49068

PHONE 1.269.789.6700

FAX 269.781.2770

E-MAIL SALES@MARSHALLEXCELSIOR.COM

WEBSITE MARSHALLEXCELSIOR.COM

