

*“I need a  
door that’s  
weather  
proof!”*



**Stylish. Secure. Solidor®**

[solidor.co.uk](https://solidor.co.uk)





*“What does your front door say about you..?”*



**Solidor®**

Leading the way in secure  
composite doors

# Introduction

The Solidor Collection is an outstanding range of industry leading, solid timber core composite doors. Each Solidor exceeds building regulation requirements and combines traditional and contemporary styling with a full range of Secured by Design locking which provides a stunning, high quality and secure entrance to any home.

With a thickness of 48mm, a Solidor door is nearly 10% thicker than most alternatives. Each unique solid timber core is completely encapsulated within a highly durable plastic edge banding and two thermo plastic door skins. This means that your customer will never have to worry about painting or varnishing their Solidor.

These doors are exclusively available in the widest range of styles and frame colour options, (23 colours available, please see page 8) with the option of a mobility threshold, making it the perfect solution for easy wheel or push chair access. We offer a comprehensive range of matching coloured frames, that are available with either glass, composite side panel or quarter panel to compliment the look of any property.

Solidor composite doors are manufactured to the highest standards. We hold BSI Kite mark accreditation BSI ISO 9001 for quality management, BSI EN1279 for insulating glass units.

We are also PAS24:2016 certified, hold CE Marking and Secured by design licences, and are members of the prestigious GGF and Association of Composite Door Manufacturers.



## Contents

- 05. Choosing Solidor
- 06. The Contemporary Collection
- 14. Security
- 16. Colour Options
- 19. The Italia Collection
- 27. Italia Collection Accessories
- 28. The Traditional Collection
- 42. Solidor French Doors
- 44. Solidor Stable Doors
- 46. Side Panels
- 48. Furniture & Accessories
- 53. Glazing Options
- 54. Jo Downs Range
- 56. Art Deco Range
- 58. Decorative Glass
- 60. Traditional Range Glass Matrix
- 62. Italia Collection Glass Matrix

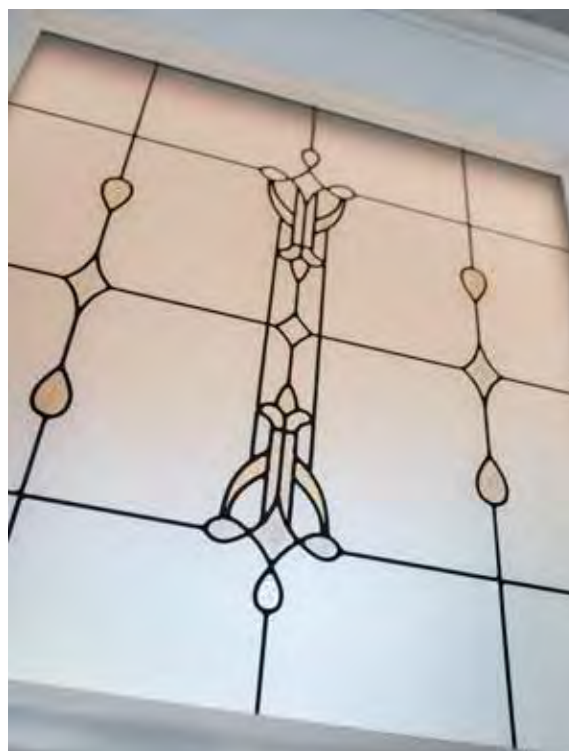

PLEASE NOTE THE IMAGES SHOWN WITHIN THIS BROCHURE ARE FOR ILLUSTRATION PURPOSES ONLY. PLEASE USE THIS BROCHURE A REFERENCE, SLIGHT CHANGES CAN OCCUR DUE CONTINUOUS IMPROVEMENT.

# Choosing Solidor®

**We understand that knowing your home and family are protected is a major factor when choosing a new door.**

You can rest assured that with our door construction, coupled with our unique, reinforced door frame and Secured by Design locking systems, your home will be as safe as can be when you choose Solidor.

## A typical foam filled door construction

## Solidor's unique solid timber construction

**40mm Foam Filled Centre** performs thermally, but because this is a foam fill it is neither solid, nor secure.

**44mm Solid Timber Core** that is thermally efficient and extremely secure.

**Visible Edge Banding** as a result you will often see a different coloured line running the length of the door.

**Hidden Edge Banding** so the front of your door remains a solid, glorious slab of colour.

**Gel Coated GRP Outer Skin** may offer protection but can be easily cut through. Also, because every door is a white blank that is surface painted they show scratches very easily.

**'Through' Colour ABS Skins** made from the same durable plastic as Lego®. Also, because the entire skin is made of a solid colour, any scratches are practically hidden.

**3 Chamber Profile** which use valuable steel or aluminium reinforcements. Also, you should check if they are lead free.

**Lead Free, 5 Chamber Profile** which uses 100% recycled reinforcing. Generally, the more chambers that a profile uses, the stronger and more thermally efficient they are.

**Wood Grain Effect Skin** that gives all of the aesthetics of timber, but without the time consuming maintenance.

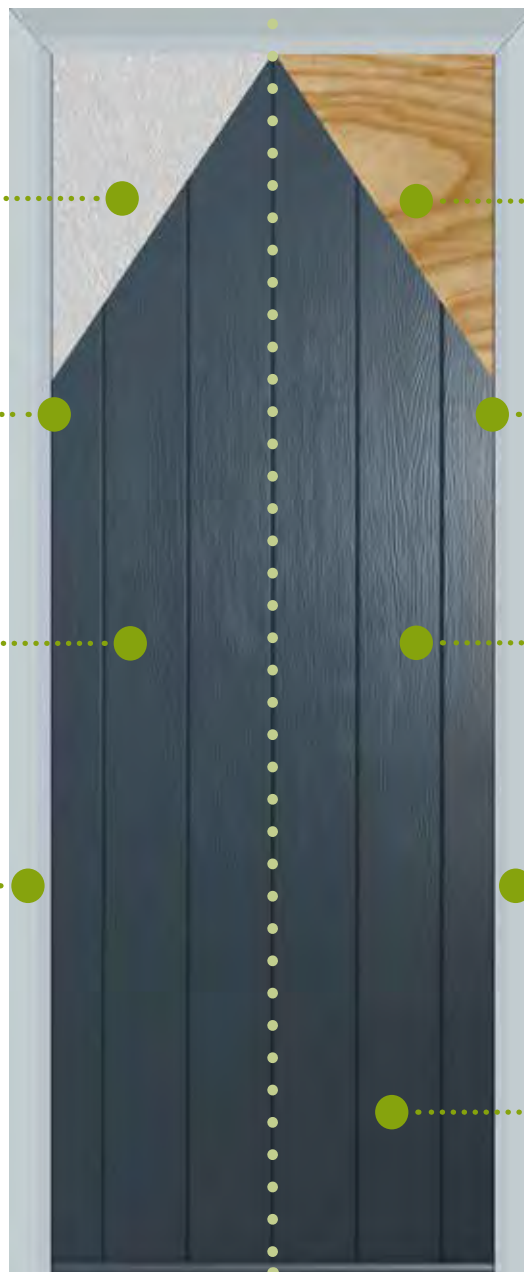

To see our security test video visit [www.solidor.co.uk/tv](http://www.solidor.co.uk/tv)



**NEW**  
for  
**2019**

Acer  
House  
9A

THE  
**Contemporary**  
RANGE

---

The Contemporary Range from Solidor is a *new and exclusive* collection of ultra sleek composite doors. Unique designs, clean lines, and a metallic aesthetic add a feel of real luxury to your home.



## Colour Options

*Four different colour options with matching outer frames, all of which are exclusive to **Solidor**.* \*Internal/external slab & frame colours are not interchangeable.

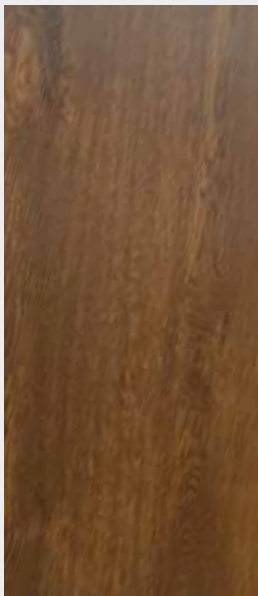

Walnut



Titan

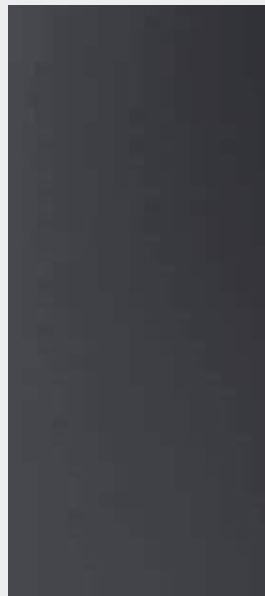

Onyx



Sapphire

\*Colours are exclusive to the Contemporary range and therefore not available within the Traditional and Italia collections.

# Avalon

A unique design with real appeal

All Contemporary doors come with satin glass



**Avalon**  
Walnut



**Avalon**  
Titan



**Avalon**  
Sapphire

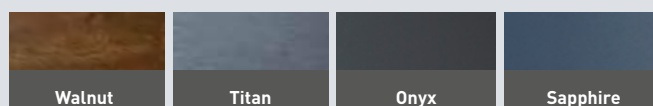



# Infinity

Understated, sleek and so very stylish



**Infinity**  
Walnut



**Infinity**  
Sapphire

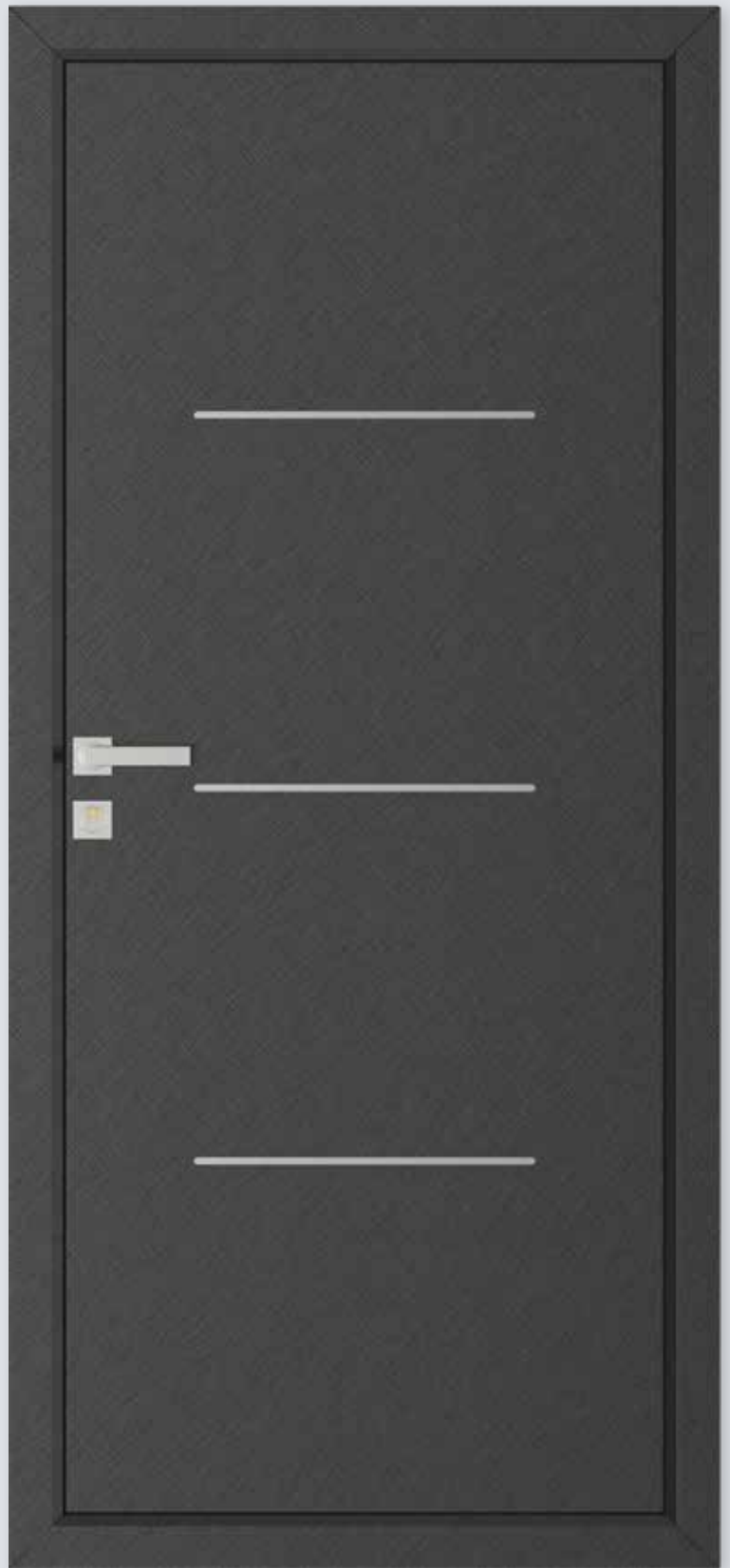

**Infinity**  
Onyx



Walnut

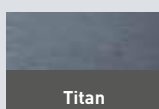

Titan

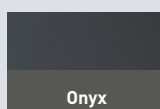

Onyx



Sapphire

# Serenity

A minimalist style that provides the ultimate statement



**Serenity**  
Onyx



**Serenity**  
Sapphire

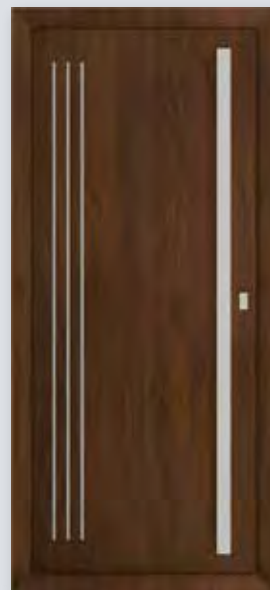

**Serenity**  
Walnut

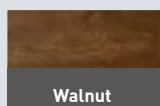

Walnut

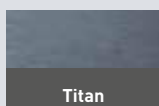

Titan

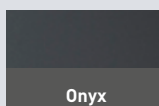

Onyx



Sapphire

# Olympus

A modernistic take on a traditional door design

All Contemporary doors come with satin glass



Olympus  
Onyx



Olympus  
Sapphire



Olympus  
Walnut

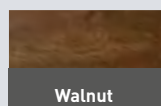

Walnut

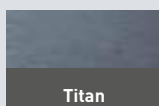

Titan

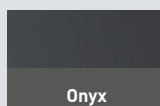

Onyx



Sapphire

# Orion

Eye-catching, ultra chic and beautifully engineered

All Contemporary doors come with satin glass



**Orion**  
Walnut



**Orion**  
Titan



**Orion**  
Sapphire

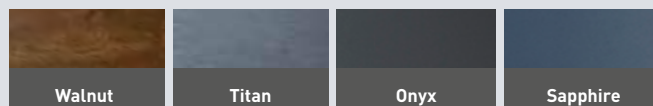

# Contemporary Accessories

An exclusive range of stainless steel furniture that will look amazing on your choice of door.

\*All Hardware is exclusive to the Contemporary range with the exception of the ES3 and EK570 handles

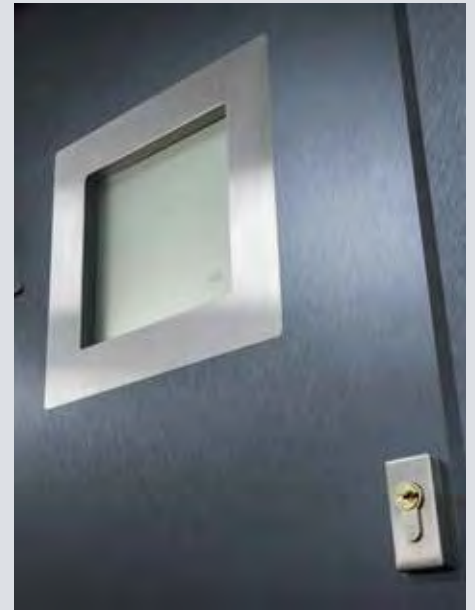

## Handles



London Lever  
on Rose

## Escutcheon Plate



EZ Escutcheon

## Pull Knob

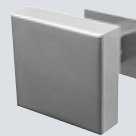

EK570

## Bar Handles



ES46 400



ES2 400



ES51 400

## Wall Mounted Letter Box



\*Must be ordered separately



ES3 1800



ES3 800

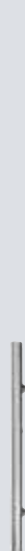

ES3 400



1S200 1800



1S200 800

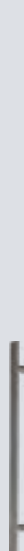

1S200 400

# Security



# The most secure composite door on the market

## Lock options

### The Largest Deadbolt in the UK!

On lever handle doors we fit our Avantis Secured by Design lock. This has the industry's largest 25.4mm deadbolt for added security.

It also has built in compression and dampeners to give the smoothest operation on the market.

### Automatic AV2 Mech Lock

The automatic AV2 mechanical lock operates as a slam secure lock as soon as the door is closed.

AV2 B allows home owners to unlock the door from a distance using a remote control device. (Only available with a lever/lever handle)

### Automatic AV3 Mech Lock

The new autoLock AV3 automatic multi-point locking system has a magnetic trigger in the frame. Two self-locking sturdy hooks provide security and two sealing elements ensure correct closure.

A daytime release function is integrated as standard with easy one-handed operation or motorised release.

## Lock Positioning



### Standard Slam Shut Auto lock

The Slam Shut lock is an automatic multi-point locking system. It features two self-locking hooks to provide additional security and two sealing elements ensure correct closure.



### Heritage Slam Shut Lock

The aesthetics of a traditional rim latch, but incorporates the latest high security slam shut technology. The lock automatically engages as the door closes.



### Key Operated Multi-Point Lock

Customers who do not want handles can upgrade to our key operated multi-point lock.

## Supreme Security Accreditations





Solidor®

5 STAR  
SECURITY



# £5000 *Home Owner* GUARANTEE



A Solidor fitted with a **3 Star Security** Ultion cylinder and **2 Star Security** LockLock handle qualifies for our **£5,000 Homeowner Guarantee**.

\*LockLock is not a requirement for Secure by Design



Offering you *real* peace of mind

**ALSO, EVERY SOLIDOR IS FITTED WITH ULTION AS STANDARD THAT MEANS IF AN INTRUDER BREAKS INTO YOUR HOME AS A RESULT OF SNAPPING ULTION, ULTION WILL PAY YOU £1000**



£1000  
GUARANTEE

Molybdenum Alloy Core  
25% denser than Iron

Resistance Sections  
Sacrificed when snapped



# A Colourful Entrance

We offer the **largest** range of colours from stock in the UK.

Choose from **23 colours** inside and/or outside for the door with **18 frame** colour options.

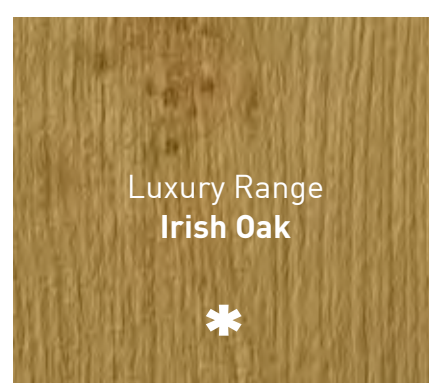
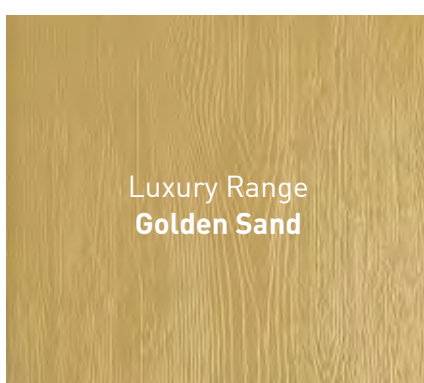
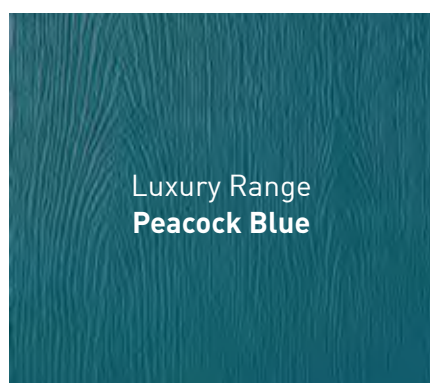
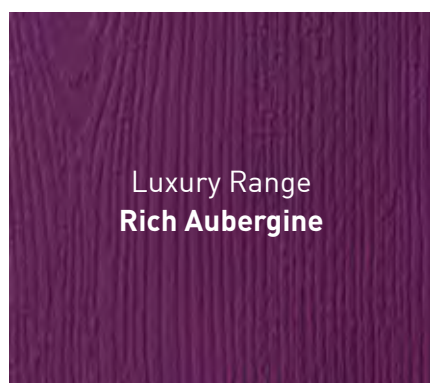
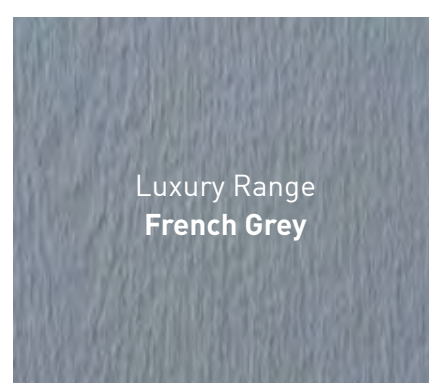
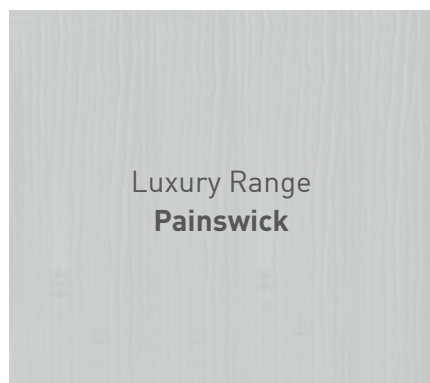

\* Available as a door and/or a frame option



\*Due to the limitations of the lithographic printing process, colour samples may not be an exact match to actual doors.

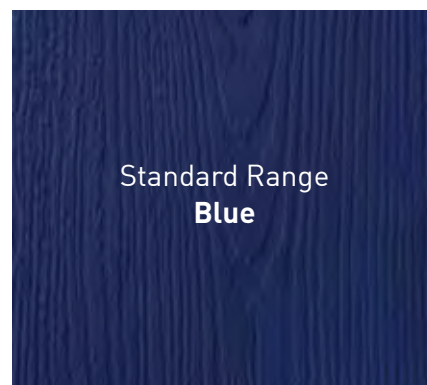
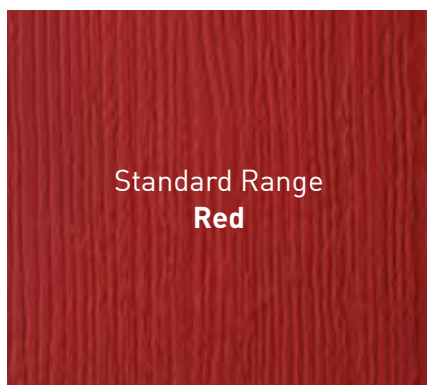
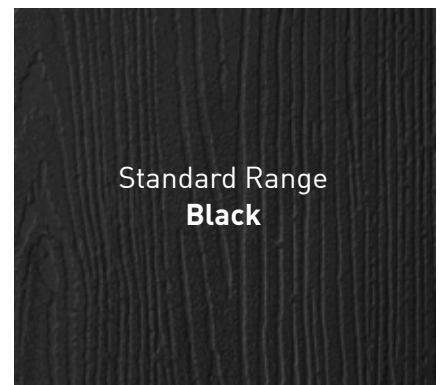
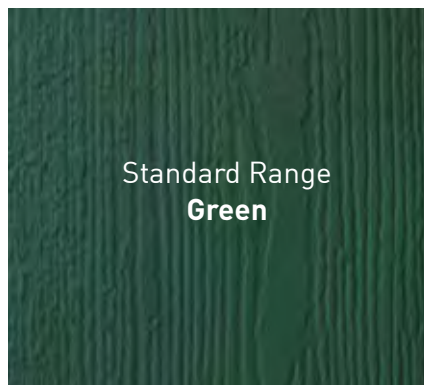
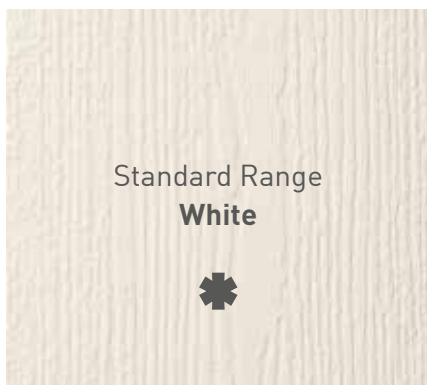
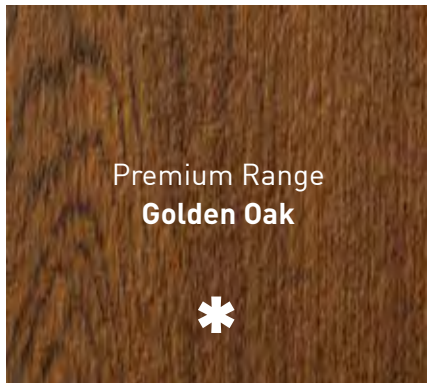
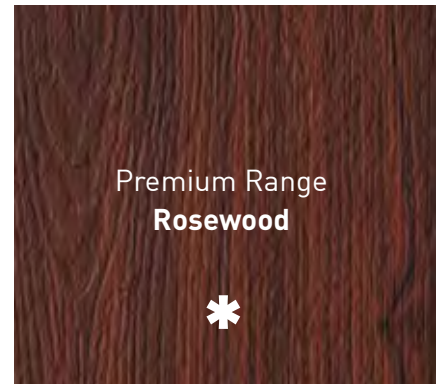
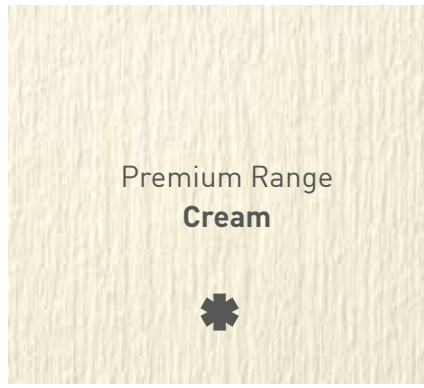

## RAL Colour Match for Solidor Door Skins

**White Skins** - RAL 9016

**Black** - RAL 9005

**Anthracite Grey** - RAL 7016

**Cream** - RAL 9001

**Rosewood** - Foiled Material

**Cobalt Blue** - Pantone 7683

**Duck Egg Blue** BRITISH STANDARD RANGE 4800/5252 REF 20-C-33

**Blue Skins** - RAL 5011

**French Grey** - RAL 7001

**Rich Aubergine** - RAL 4007

**Foiled White** - RAL 9010

**Twilight Grey** - Pantone 7544

**Chartwell Green** RAL 6021 (not a perfect match)

**Green Skins** - RAL 6009

**Painswick** - RAL 7038

**Irish Oak** - Foiled Material

**Golden Oak** - Foiled Material

**Lavender** - Pantone 5285

**Red Skins** - RAL 3011

**Schwarzbraun** - RAL 8022

**Walnut** - Foiled Material

**Peacock Blue** - BS381C103

**Golden Sand** - RAL 1002

Please note that all RAL colours are LAB matched and a slight difference in colour can occur. If you are matching paint to one of our doors it is advised that you ask for a colour swatch.





# THE Italia Collection

The Italia collection from Solidor is a new generation of truly contemporary designs which will add a touch of style to your home. Carefully designed and crafted from the finest materials, every door in the Italia collection has a definite style inspired by the Italian passion for design.

Each door is handmade in Staffordshire, ensuring the finished product is of an outstanding quality and made as individual as can be. Choose from a range of glass styles and door furniture which have been carefully chosen with the latest fashion and designs in mind. All of the doors in the Italia Collection are also available with Warwick Glass - hand made so no two pieces are ever the same.

# Trieste

Trieste in Peacock Blue with lever /  
lever and key only security locking  
option



All Italia doors are available  
with or without grooves



Colour - Anthracite Grey  
Glass - Park Lane



Colour - Green  
Glass -Dorchester

Red	Green	Blue	Black	White	Duck Egg Blue	Walnut	Irish Oak	Rich Aubergine	Chartwell Green	Cobalt Blue	Twilight Grey
French Grey	Foiled White	Anthracite Grey	Golden Oak	Schwarzbraun	Rosewood	Cream	Peacock Blue	Golden Sand	Painswick	Lavender	

# Milano

Milano in Anthracite Grey with ES3 1800 door handle and key only security locking option



See the full range of glass options from page 55

# Rimini

Rimini in Irish Oak, with ES3 1800 door handle, Satin glass and key only security locking option

Bar handles will be at least 110mm from the edge of the door slab.



## Messina



Colour - Rosewood  
Handle - ES3 400mm

## Brescia



Colour - French Grey  
Handle - ES3 1800mm

## Ancona



Colour - Cream  
Handle - EK53  
Glass - CFT 18.1

## Ancona Solid



Colour - Golden Oak  
Handle - ES3 1800mm

See the full range of glass options from page 55

# Parma

Parma in Schwarzbraun, with ES3 1800 door handle, Potomac glass and key only security locking option



## Sorrento Biella



Colour - Cream  
Handle - ES3 400mm



Colour - Foiled White  
Handle - Lever/Lever

## Venice Garda



Colour - Peacock Blue  
Handle - ES3 1800mm



Colour - Painswick  
Handle - ES24

Red	Green	Blue	Black	White	Duck Egg Blue	Walnut	Irish Oak	Rich Aubergine	Chartwell Green	Cobalt Blue	Twilight Grey
French Grey	Foiled White	Anthracite Grey	Golden Oak	Schwarzbraun	Rosewood	Cream	Peacock Blue	Golden Sand	Painswick	Lavender	

# Amalfi

Amalfi in Golden Sand with Matrix glass and ES21 door handle



## Modena



Colour - Anthracite Grey  
Handle - ES24

## Genoa



Colour - Golden Oak  
Handle - ES3 400mm

## Siena



Colour - Walnut  
Handle - ES23  
Glass - Abstract

## Pisa



Colour - Chartwell Green  
Handle - ES23  
Glass - Abstract

Red	Green	Blue	Black	White	Duck Egg Blue	Walnut	Irish Oak	Rich Aubergine	Chartwell Green	Cobalt Blue	Twilight Grey
French Grey	Foiled White	Anthracite Grey	Golden Oak	Schwarzbraun	Rosewood	Cream	Peacock Blue	Golden Sand	Painswick	Lavender	



# Bologna

Bologna in Painswick with Bullseye glass, ES 24 door handle and key only security locking option

All Italia doors are available with or without grooves



## Roma



Colour - Golden Sand  
Handle - ES21

## Monza



Colour - Painswick  
Handle - ES21

## Verona



Colour - Duck Egg Blue  
Handle - ES3 1800mm

## Naples



Colour - Schwarzbraun  
Handle - Lever/Lever

See the full range of glass options from page 55

# Palermo

Palermo in Luxury Walnut with ES3 1800 door handle

Bar handles will be at least 110mm from the edge of the door slab.



## Turin

## Monza



Colour - Chartwell Green  
Handle - Lever/Lever



Colour - Painswick  
Handle - ES21

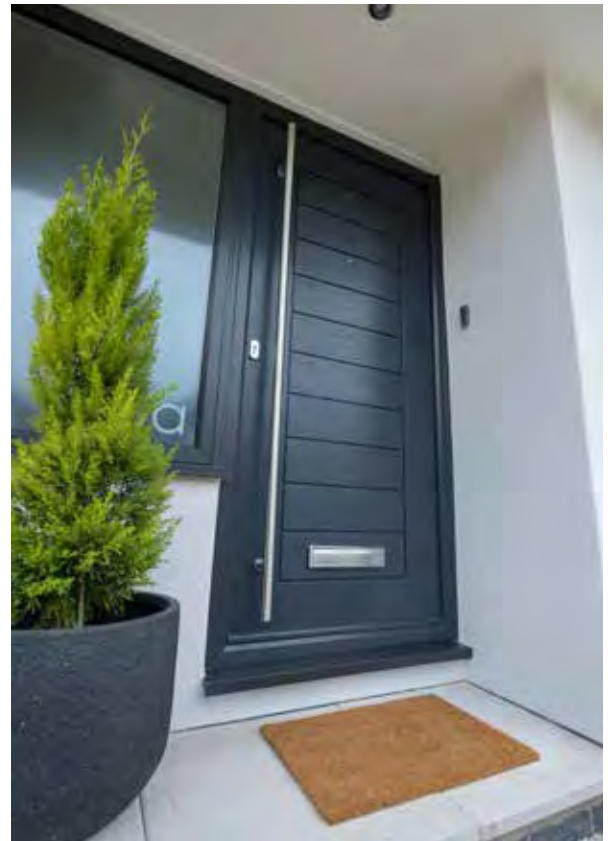

Red	Green	Blue	Black	White	Duck Egg Blue	Walnut	Irish Oak	Rich Aubergine	Chartwell Green	Cobalt Blue	Twilight Grey
French Grey	Foiled White	Anthracite Grey	Golden Oak	Schwarzbraun	Rosewood	Cream	Peacock Blue	Golden Sand	Painswick	Lavender	

## Italia Accessories

Designer handle range for our key only operated and slam shut auto locks



ES3 800mm



ES24



ES23



ES3 1800mm

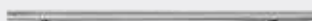

ES3 800mm

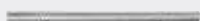

ES3 400mm

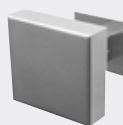

EK570



ES21



ES24



EK53



ES23

Bar handles will be at least 110mm from the edge of the door slab.

## Pilkington Texture Glass Warwick™

This design is unique amongst our patterns because it is produced using a different manufacturing method. Pilkington Texture Glass Warwick™ is a random pattern that is added along the central portion of the pane and this has implications when cutting the glass down into finished sizes. It is possible, if a pane is small enough, it could be cut with no evidence of the pattern at all.

None of the Pilkington patterns are designed to have an orientation (an up side) but care needs to be taken with adjacent panes that the pattern direction is maintained. There is a linear nature to Pilkington Texture Glass Warwick™ and so householders should be aware that there could be aesthetic implications when choosing this design. Also, for the glass supplier the result may be that this pattern is less accommodating when cutting and may result in a greater proportion of seldge from the original glass plate.



Warwick Glass available in all of our Italia doors



Abstract Glass available in the Pisa, Turin and Siena



Satin Glass available in all of our doors

This information is intended for illustration purposes only and may be subject to change for reasons beyond our control. As a consequence this brochure should be used for guidance only.



# THE Traditional Collection

The Traditional collection from Solidor, brings classic designs into the modern era. Each door design is suited to both traditional and modern properties alike, and will add a touch of elegance to every home.

# Stirling



Colour - Lavender  
Glass - Satin  
Handle - Lever/Lever



Colour - Twilight Grey  
Glass - Caledonian Rose  
Handle - Lever/Lever



Colour - Blue  
Glass - Oceanic  
Handle - Lever/Lever

Red	Green	Blue	Black	White	Duck Egg Blue	Walnut	Irish Oak	Rich Aubergine	Chartwell Green	Cobalt Blue	Twilight Grey
French Grey	Foiled White	Anthracite Grey	Golden Oak	Schwarzbraun	Rosewood	Cream	Peacock Blue	Golden Sand	Painswick	Lavender	

# London



Colour - French Grey  
Glass - Park Lane



Colour - Peacock Blue  
Glass - Caledonian Rose



Colour - Golden Oak  
Glass - Dorchester

# Berkeley



Colour - Red  
Glass - Matrix



Colour - Golden Oak  
Glass - Caledonian Rose



Colour - Duck Egg Blue  
Glass - Dorchester

See the full range of glass options from page 55

# Edinburgh



Colour - Golden Sand  
Glass - Park Lane



Colour - Peacock Blue  
Glass - Satin



Colour - Cream

# Alnwick



Colour - Anthracite Grey  
Glass - Satin



Colour - Chartwell Green  
Glass - Modena



Colour - Schwarzbraun  
Glass - Park Lane

Red	Green	Blue	Black	White	Duck Egg Blue	Walnut	Irish Oak	Rich Aubergine	Chartwell Green	Cobalt Blue	Twilight Grey
French Grey	Foiled White	Anthracite Grey	Golden Oak	Schwarzbraun	Rosewood	Cream	Peacock Blue	Golden Sand	Painswick	Lavender	

# Conway



Colour - Foiled White  
Glass - Caledonian Rose



Colour - Cobalt Blue  
Glass - Elegance



Colour - Rosewood

# Nottingham



Colour - Red  
Glass - Quad Black



Colour - French Grey  
Glass - Brilliance



Colour - Schwarzbraun  
Glass - CTB19.2

Red	Green	Blue	Black	White	Duck Egg Blue	Walnut	Irish Oak	Rich Aubergine	Chartwell Green	Cobalt Blue	Twilight Grey
French Grey	Foiled White	Anthraccite Grey	Golden Oak	Schwarzbraun	Rosewood	Cream	Peacock Blue	Golden Sand	Painswick	Lavender	



# Harlech



Colour - Black  
Glass - Black Diamond



Colour - Peacock Blue  
Glass - Jewel



Colour - Walnut  
Glass - CTB 17.2

# Tenby



Colour - Painswick  
Glass - Quad Grey



Colour - Rich Aubergine  
Glass - Reflections



Colour - Duck Egg Blue  
Glass - Caledonian Rose

See the full range of glass options from page 55

# Ludlow



Colour - Painswick  
Glass - London Etch Border



Colour - Peacock Blue  
Glass - Dorchester

See the full range of glass options from page 55



Colour - Cobalt Blue  
Glass - Fairmount



Colour - Anthracite Grey  
Glass - Brilliante



Colour - French Grey  
Glass - Paramount

Red	Green	Blue	Black	White	Duck Egg Blue	Walnut	Irish Oak	Rich Aubergine	Chartwell Green	Cobalt Blue	Twilight Grey
French Grey	Foiled White	Anthracite Grey	Golden Oak	Schwarzbraun	Rosewood	Cream	Peacock Blue	Golden Sand	Painswick	Lavender	

# Beeston



Colour - Duck Egg Blue  
Glass - Satin



Colour - Rosewood  
Glass - Integrated Blind  
\*White Blind with clear glass only



Colour - Black  
Glass - Elegance

# Stafford



Colour - French Grey  
Glass - Royale



Colour - Foiled White  
Glass - Elegance



Colour - Rich Aubergine  
Glass - Clarity (Gold Only)

Red	Green	Blue	Black	White	Duck Egg Blue	Walnut	Irish Oak	Rich Aubergine	Chartwell Green	Cobalt Blue	Twilight Grey
French Grey	Foiled White	Anthracite Grey	Golden Oak	Schwarzbraun	Rosewood	Cream	Peacock Blue	Golden Sand	Painswick	Lavender	

# Windsor

# Thornbury



Colour - Golden Sand



Colour - Anthracite Grey



Colour -Schwarzbraun



See the full range of glass options from page 55

# The Flint Range



Flint Solid  
Colour - Duck Egg Blue



Flint 1  
Colour - Anthracite Grey  
Glass - Bullseye



Flint 2  
Colour - Golden Sand  
Glass - CTB 18.1



Flint 3  
Colour - Chartwell Green  
Glass - Trio Square Green



Flint 4  
Colour - Golden Oak  
Glass - Diamond Lead



Flint 5  
Colour - Painswick  
Glass - Modena

See the full range of glass options from page 55



Flint Beeston  
Colour - Red  
Glass - Brilliante



Flint Square  
Colour - Rich Aubergine  
Glass - Bullseye



Red	Green	Blue	Black	White	Duck Egg Blue	Walnut	Irish Oak	Rich Aubergine	Chartwell Green	Cobalt Blue	Twilight Grey
French Grey	Foiled White	Anthraccite Grey	Golden Oak	Schwarzbraun	Rosewood	Cream	Peacock Blue	Golden Sand	Painswick	Lavender	



## IDEA

Use wall spaces to display an alternative classic letterbox, in a style to complement your door.

*TIP: Make a statement and frame the doorway with a walled path for a truly grand entrance!*

# Classic

British design



# Ludlow

With a truly natural looking woodgrain effect, our classic British door designs are *timeless*.

Achieve an authentic Victorian look with the Ludlow, fast becoming **Britain's most popular door**.

With simple clean lines, the Ludlow has the power to create either a modern or a traditional entrance for your home. Available as a solid door for added privacy, or with two glazed panels, the Ludlow combines classic Victorian design with modern materials. Either option will create a polished and sophisticated entry.

## ▼ *Lighten it up*

Open up your front entry with glazed panels on both sides of your door. They will flood your hallway with light, make your entry seem larger, and enhance your home's architectural style.



## ◀ *All in the detail*

Our elegantly shaped handles and accessories in sleek chrome suit this Ludlow perfectly.

Visit [www.solidor.co.uk/accessories](http://www.solidor.co.uk/accessories) to view our range of hardware



## ▲ *Back to basics*

Keep it simple by adding ornate planters either side of the door or a hard wearing welcome mat - enough to complete the subtle look in smaller spaces.

## Which Colour?

Choose Schwarzbraun with stained glass and traditional door furniture to retain the door's original Victorian charm, or give it a contemporary edge by opting for French Grey with polished chrome accessories.

Choose your colour from our new and updated range on page 18 →→

Schwarzbraun

French Grey

# French Doors



All of our designs, in all of our colours are available in a French Door option, with a range of handle options, encompassing a high security, adjustable, multipoint locking system.



Available as inward or outward opening doors. Because our French door range is so vast, please contact us for the minimum and maximum sizes before you order your set.

**NOTE:** Available with UPVC and aluminium threshold on inward opening sets, and UPVC only on outward opening sets.

Flush, integrated two way lever, which throws the shootbolts and removes the need for a lever handle and cylinder to give the option to use our Italia Collection handles on both leaves, alternatively, go for lever operated!

Standard option is both doors to be lever handle operated.

# Stable Doors

The majority of our standard and many of the Italia Collection door styles are available as open in (only) stable doors. Available in any colour on any side.

(contact us for more details)

**Solidor**<sup>®</sup>  
EXCLUSIVE

Secured by Design



Police Preferred Specification



All of our stable doors come with a high security, fully adjustable multi-point locking system. They are also keyed alike, benefit from an internal thumb turn cylinder on the top and bottom half and have a latching security bolt as standard.





# Side Panels



**Complement your property with a full range of matching full height and half side panels.**

(contact us for details on the full range of side panels available)



Half Moulded



Half Flat Grain



Quarter Moulded



Milano Side Panel



Milano



Brescia



Thornbury

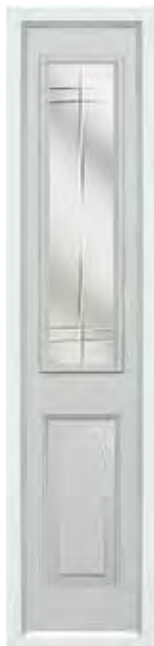

Ludlow



Harlech



Available in all of our colour options!

Tenby



Nottingham







# Furniture & Accessories

A selection of beautiful accessories and high security locks to perfectly compliment your choice of door. Whether contemporary or traditional you will find an accessory to really make your door stand out.

## Door Knockers



Doctor



-  Chrome
-  Gold
-  Brushed
-  Black Chrome
-  White
-  Black

Premium 7" Doctor









-  Chrome
-  Gold

Urn







Available with or without spyhole



-  Chrome
-  Gold
-  Brushed
-  Black Chrome
-  White
-  Black
-  Antique Black

Pony Tail



-  Chrome
-  Gold
-  Brushed
-  Black Chrome
-  White
-  Black

Stainless Steel









-  Steel

Lion





Not available on Tenby 4, Conway 3, Ludlow, Edinburgh, Harlech or Nottingham



-  Chrome
-  Gold
-  Black Chrome
-  White
-  Black
-  Brushed Ali







## Viewer



-  Chrome
-  Gold
-  White
-  Black

## Letterplates



-  Chrome
-  Gold
-  Brushed
-  Black Chrome
-  White
-  Black
-  Antique Black



## The Architectural Range

Knocker

Brushed



Lever / Lever inline handle

Brushed



Letterplate (Opens inwards)

Brushed



## The Classical Range

Bullring Knocker

Chrome

Gold

Antique Black



Lever / Lever inline handle

Chrome

Gold

Antique Black



Pull Knob

Chrome

Gold

Antique Black



Letterplate (opens inwards)

Chrome



Gold

Antique Black



## Butt Hinge









-  Gold
-  White
-  Black

## Hinges

Our new slimline, PAS 23-24 tested, face fixed flag hinge is sleek and modern.







-  Chrome
-  Gold
-  Brushed
-  Black Chrome
-  White
-  Black

## Handles

A large range of premium quality handles to complement our doors. Available with a choice of a standard lever or one of the three exclusive options across the whole range of finishes.







### Swan Hardex



-  Chrome
-  Gold
-  Brushed
-  Black Chrome
-  Antique Black







### Lever Hardex



-  Chrome
-  Gold
-  Brushed
-  Black Chrome
-  White
-  Black
-  Antique Black



### Lever Pad



-  Chrome
-  Gold
-  Brushed
-  Black Chrome
-  White
-  Black
-  Antique Black



## Door Knob



-  Chrome
-  Brushed

## Trojan Letterplates

Stainless steel specifically for coastal properties

-  Chrome
-  Brushed
-  Gold

Standard



TS008 SBD Only (White internal)



## Trojan Urn

Stainless steel specifically for coastal properties





-  Gold
-  Chrome
-  Brushed



## Trojan Handles

Stainless steel specifically for coastal properties







-  Gold
-  Chrome
-  Brushed



## Extra Security





### Security Door Guard



-  Chrome
-  Gold
-  Brushed
-  White
-  Black

### Stable Door Latch Suited where possible





-  Chrome
-  Gold
-  Brushed
-  Black

## Ironmongery

We have a range of stunning traditional knockers and handles that add a real touch of class.



### Traditional Avon Slimline



-  Black
-  Pewter



### Traditional Monkey Tail



-  Black
-  Pewter



### Traditional Cottage



-  Black
-  Pewter

### Traditional Pull Knob





-  Pewter
-  Black

### Teardrop Knocker

Not available on Tenby 4, Conway 3, Ludlow, Edinburgh, Harlech or Nottingham





-  Pewter
-  Black

### Handmade Ring

Not available on Tenby 4, Conway 3, Ludlow, Edinburgh, Harlech or Nottingham





-  Pewter
-  Black

### Traditional Letterplate

Letterplate for illustrative purposes only  
Opens outwards









-  Pewter
-  Black

## Finger pulls

Available with the heritage lock



-  Chrome
-  Gold
-  Satin
-  Antique Black
-  Black Chrome
-  White
-  Black

# Finishing Options

## OUTER FRAME OPTIONS

Which frame would you like? Choose from Kömmerling Chamfered C70 or Sculptured O70 outer frame.



## EDGE BANDING COLOURS

White as standard, brown on Rosewood / Walnut, Anthracite Grey on Schwarzbraun, Black, and Anthracite Grey when coloured both sides, caramel on Golden Oak and Irish Oak when coloured both sides. For all other dual colour combination white edge band is use.

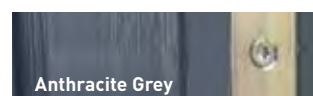
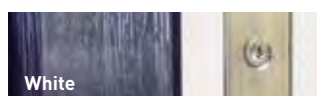

## Thresholds

To allow for every circumstance we offer the largest range of door thresholds. The AM3 and AM5EX aluminium threshold are both Part 'M' compliant within the latest Building Regulations for easy access.

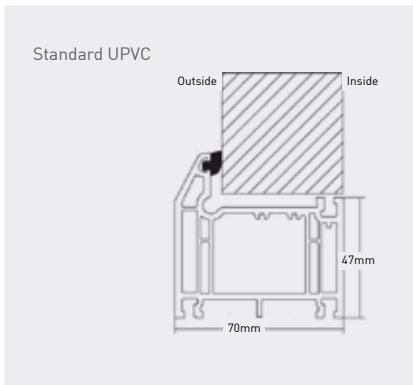
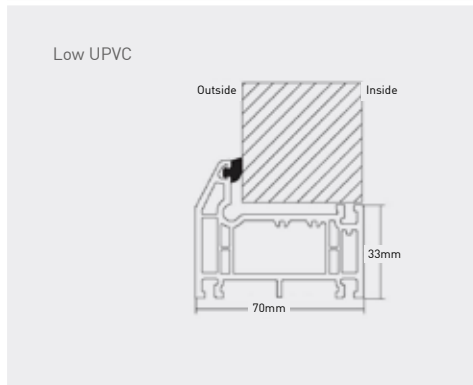
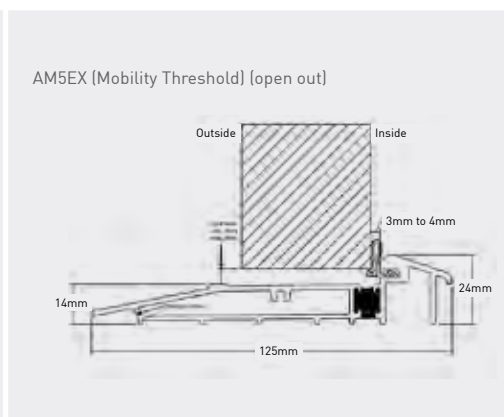
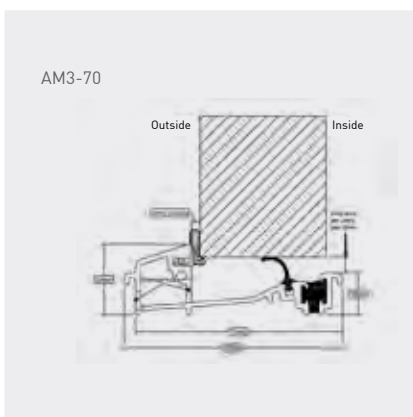
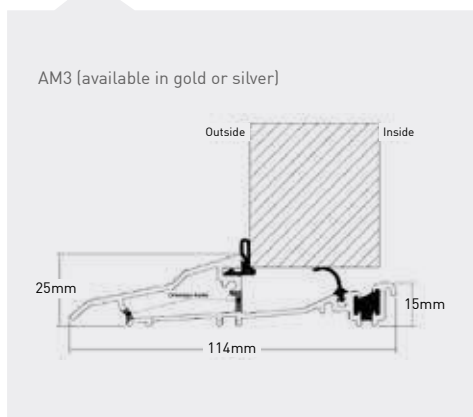

AM3/AM5 not compatible with PVC cill



# Amazing Glazing

A fine selection of beautiful glass to perfectly complement your choice of door. Whether modern or traditional you will find a glass style to really make your door stand out.

# Jo Downs

HANDMADE GLASS



**Solidor**<sup>®</sup>  
EXCLUSIVE

Jo Downs is one of the world's most respected fused glass designers. Working from her Cornwall studio, Jo's work draws inspiration from the beautiful coastal landscape while her advanced fusion techniques allow for the creation of abstract designs of great individuality and depth.

\*Please be aware that each piece is individually hand crafted and therefore no two pieces are the same.

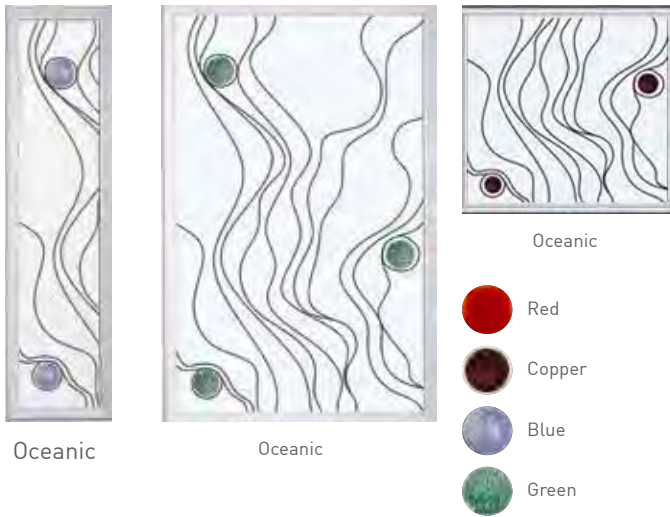

The stunning Cornish landscape that inspires Jo's work

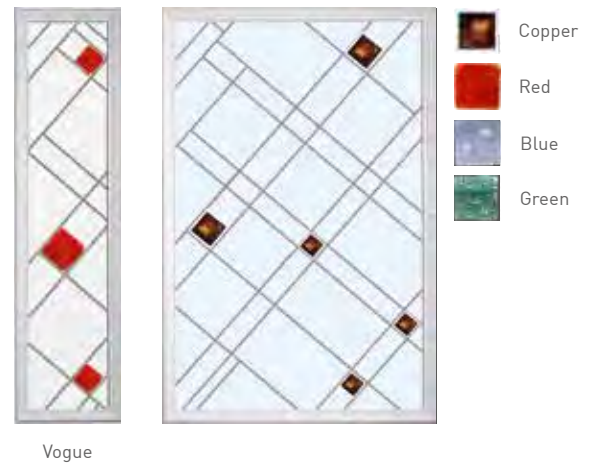
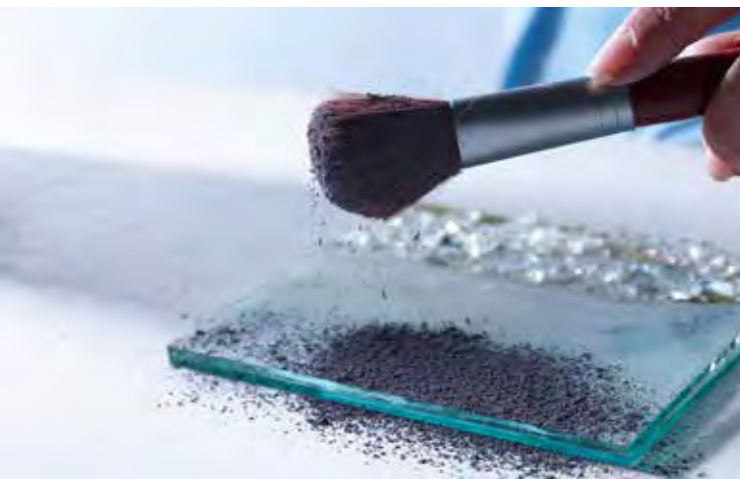

Using carefully selected materials, the glass tiles are laid out and then baked in a kiln, producing really eye catching results.

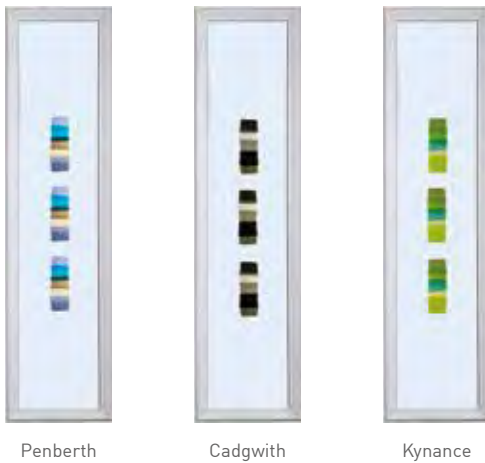

Hand crafted, each piece of glass is unique, turning the door to your home into a stunning work of art.

**Solidor**<sup>®</sup>  
EXCLUSIVE

# Artistic Glass



Inspired by classical artistic styles, such as art deco, minimalism, and the impressionist movement, The Modernist Range of glass is unique to Solidor.

(Featured hinge is no longer available, please see page 40 for new hinge option)



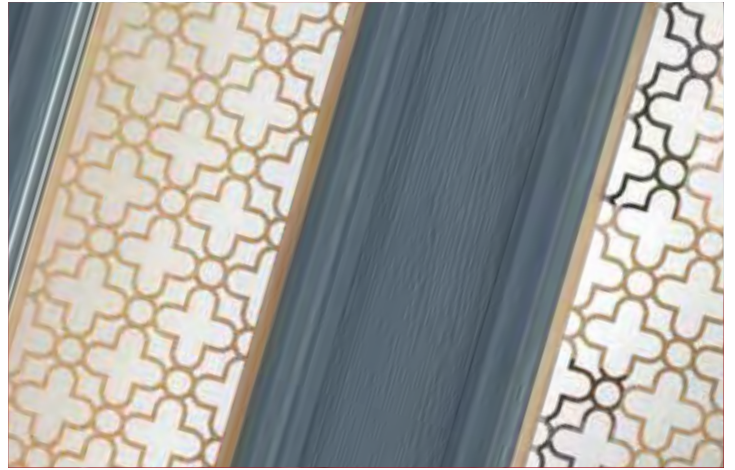

Fairmont



Paramount



Wiltren



Gaumont



Tate



Fairmont



Paramount

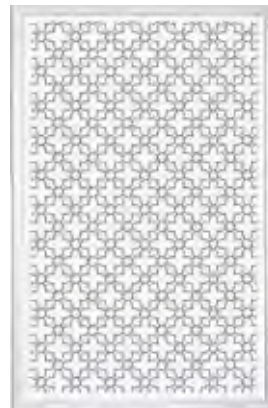

Wiltren



Tate

# Traditional Range Backing glass required



**Trio Square**  
Black



**Trio Square**  
Blue



**Trio Square**  
Butterscotch



**Trio Square**  
Green



**Trio Square**  
Grey



**Trio Square**  
Red



**Trio Square**  
Sea Green



**Diamond**  
Black



**Diamond**  
Black & White

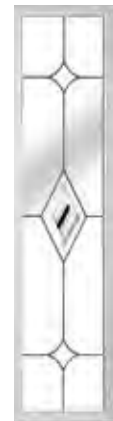

**Diamond**  
Butterscotch



**Diamond**  
Red



**Quad**  
Black



**Quad**  
Blue



**Quad**  
Grey



**Quad**  
Red



**CSB 5.1FT**



**CGB-F**  
Cassette only not internal glass



**CTL 6.1**



**Open Blind**  
Clear glass only



**Closed Blind**



**CGB-F**  
Clear bevels available



**CTB 18.1**

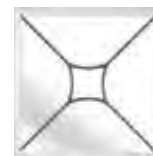

**Star Clear**



**Star Black**

Decorative Glass Backing glass not optional.



Matrix



Modena  
End result dependent  
on door style



Park Lane  
Bespoke



Victorian



Zinc Art Star



Caledonian  
Rose Handed



Dorchester



Etched Squares



Linear



London Etch  
Border



Abstract



Brilliante



Clarity - GOLD



Elegance



Simplicity



Potomac

Backing glass required



Prairie



Reflections



Royale



CFT 2.1



CTB 17.2



CTB 19.2



CTL 31.2B



Jewel

# Traditional Range Matrix

	Gaumont	Jo Downs - Kymene, Clapham, Penlith	Vogue	Oceanic	Fairmont	Paramount	Wiltren	Tate	Victorian	CRL 2.1	CRL 2.3	CTB 18.1	Trio Square Sea Green/Green	London Etch	Clear/Black Star	Dorchester	Zinc Art Star	Trio Square Butterscotch	Caladonian Rose	Park Lane Bespoke	Modena	Potomac	Reflections	Trio Squ Red	Trio Squ Grey	Trio Squ Blue	Trio Squ Black	Simplicity	Royale	
London															✓				✓	✓										
Alnwick																				✓	✓									
Edinburgh																				✓										
Berkeley																✓	✓				✓		✓						✓	
Conway 1										✓						✓	✓			✓			✓	✓	✓	✓	✓	✓	✓	✓
Conway 3											✓					✓	✓			✓			✓	✓	✓	✓	✓	✓	✓	✓
Ludlow	✓	✓	✓	✓	✓	✓	✓	✓	✓					✓		✓	✓			✓	✓	✓	✓	✓	✓	✓	✓	✓	✓	
Nottingham	✓	✓	✓	✓	✓	✓	✓	✓									✓			✓	✓		✓	✓	✓	✓	✓	✓	✓	
Harlech	✓	✓	✓	✓	✓	✓	✓	✓									✓			✓	✓		✓	✓	✓	✓	✓	✓	✓	
Tenby 2																✓	✓			✓			✓						✓	
Tenby 4																✓	✓			✓			✓						✓	
Beeston	✓		✓	✓	✓	✓	✓	✓					✓	✓					✓	✓		✓							✓	
Flint 1													✓	✓	✓				✓											
Flint 2												✓																		
Flint 3													✓		✓															
Flint 4		✓	✓	✓	✓	✓	✓	✓	✓											✓			✓	✓	✓	✓	✓	✓	✓	
Flint 5																				✓	✓	✓	✓							
Flint Squ													✓	✓	✓															
Stafford													✓				✓	✓		✓	✓		✓					✓	✓	
Stirling				✓					✓					✓		✓			✓	✓										

	Etch Square	Linear	Matrix	Bullseye	Abstract	Brilliant	CTF 2.1/2	Clarity - Gold Only	CTB12.3 B6	CTL 6.1	CTB 17.1/17.2	CTB12.3 Clear	CSB 5.1 FT	CTL 31.2B	CTB 19.1/19.2	Diamond Black	Diamond B&W	Diamond Butterscotch	Diamond Red	Elegance	Jewel	Prairie	Quad Black	Quad Blue	Quad Grey	Quad Red	
London																											
Alnwick																											
Edinburgh																											
Berkeley																											
Conway 1																											
Conway 3																											
Ludlow																											
Nottingham																											
Harlech																											
Tenby 2																											
Tenby 4																											
Beeston																											
Flint 1																											
Flint 2																											
Flint 3																											
Flint 4																											
Flint 5																											
Flint Squ																											
Stafford																											
Stirling																											

# Italia Range Matrix

	Gaumont	Wish Stick	Vogue	Oceanic	Fairmont	Paramount	Wiltorn	Tate	Victorian	CRL 2.1	CRL 2.3	CTB 18.1	Trio Square Sea Green	CTB 19.2	CTB 17.2	London Etch	Clear/Black Star	Dorchester	Zinc Art Star	Trio Square Butter/Scotch	Caladonian Rose	Park Lane	Modena	Potomac	Reflections	Trio Squ Red	Trio Squ Grey	Trio Squ Ble	Simply
Amalfi																													
Brescia																													
Milano																								✓					
Naples																													
Pisa																								✓					
Roma																													
Sienna																								✓					
Turin	✓	✓	✓	✓	✓	✓	✓	✓		✓														✓	✓	✓	✓	✓	✓
Monza																							✓	✓	✓	✓			
Parma																								✓					
Trieste																✓		✓					✓	✓					



Trio Square  
Black



Trio Square  
Blue



Trio Square  
Butterscotch



Trio Square  
Green



Trio Square  
Grey



Trio Square  
Red



Trio Square  
Sea Green



Potomac



Bullseye

	Matrix	CTF 2.2	Linear	Bullseye	Abstract	Brilliant	Clarity - Gold Only	CTB12.1	CTB12.3 BG	CTL 6.1	CTB17.1	CTB12.3 Clear	OSB 5.1 FT	CTL 31.2B	CTB 19.1	Diamond Black	Diamond B&W	Diamond Butterscotch	Diamond Red	Elegance	Jewel	Prairie	Quad Black	Quad Blue	Quad Grey	Quad Red	Royale
Amalfi	✓		✓																								
Brescia	✓		✓																								
Milano																											
Naples				✓																							
Pisa					✓																						
Roma																											
Sienna					✓																						
Turin					✓	✓	✓				✓				✓	✓	✓	✓	✓	✓	✓	✓	✓	✓	✓	✓	✓
Monza																											
Parma				✓																							
Trieste																											



CTB 17.2

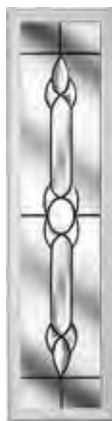

CTB 19.2



Abstract



Brilliant



Clarity - GOLD



Elegance



Prairie



Reflections

Tie the vintage look together with wicker or ceramic hanging baskets.

**Selina Says**

*“Solidor gave me the realistic wood grain effect I was looking for, but they use modern materials for absolute piece of mind”*

*Style guru*  
**Selina Lake**  
*chooses Solidor®*



# Beeston Stable

Vintage farmhouse or chic and contemporary, the style is as adjustable as the door itself.

Suited to both period and modern properties alike, the **Beeston Stable Door** allows you to bring the outside into your home.

## ► *Bring the outside in*

*"They're a great option for a side or rear door" says Selina. "The two independently operating doors bring the outdoors inside, increase the flow of natural light, help with air circulation during the warm summer months, and all the while keep your children and pets safely contained."*



## *Make a feature* ▲

Selina decorated her door with a wreath (they aren't just for Christmas you know!) Keep your door looking fresh all year round by replacing the door wreath with the changing seasons.

**All of our standard, and many of our Italia Collection, door styles can be converted into a stable door.**

## ▼ *Create a landing spot*

Give your outdoor space or porch area a sense of comfort by placing a piece or two of weather-resistant furniture near the entry. A bistro set is an easy addition for any patio size, and a perfect spot to relax outdoors with a cup of coffee!



## Selina Says

*"It took a while for us to decide what colour to choose, but their design your own door application was fantastic, I'm so happy we went for Anthracite Grey."*

**Selina used our online door designer to create her dream door. Try it for yourself here:**

<http://doordesigner.solidor.co.uk/>



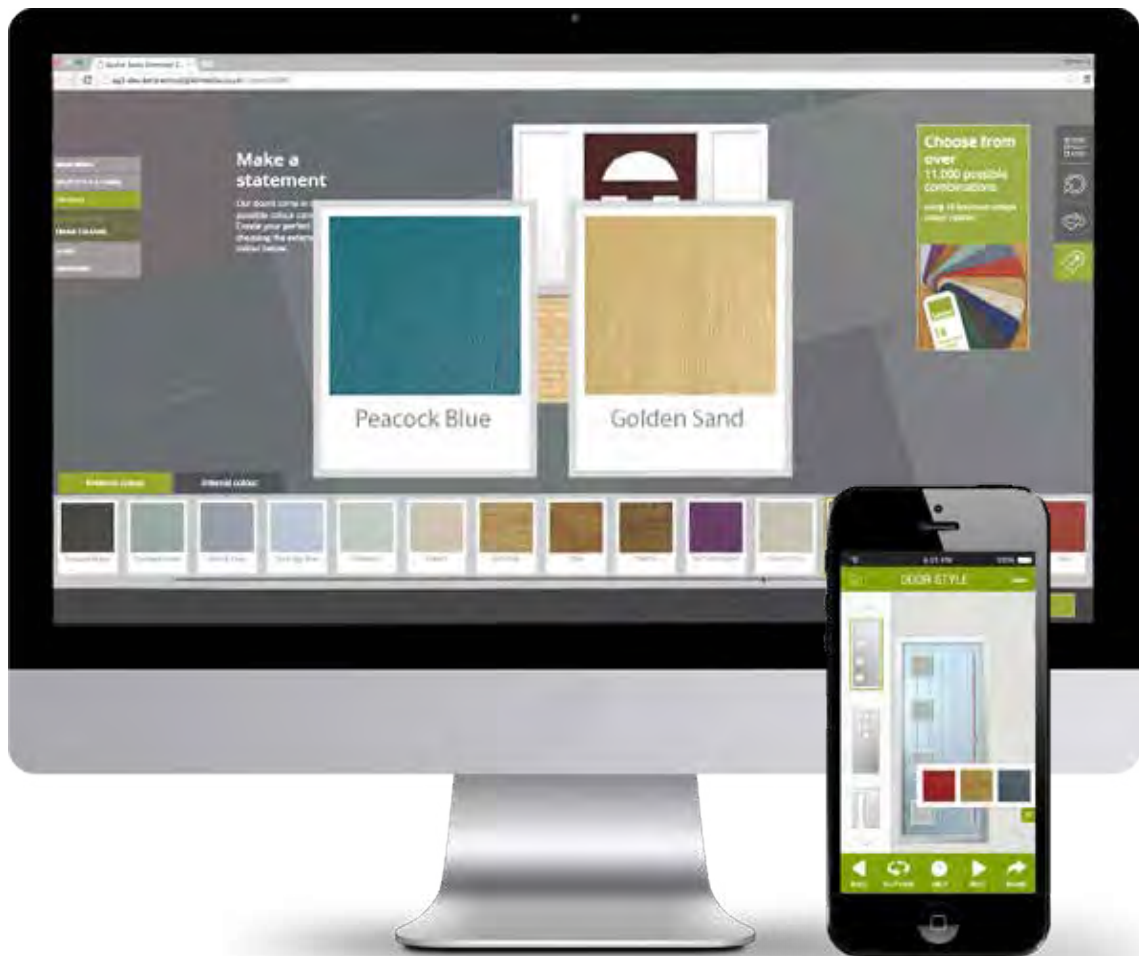

To create your perfect Solidor go online

[www.doordesigner.solidor.co.uk](http://www.doordesigner.solidor.co.uk)



**MASONITE®**

