

maier

Rotary joints
Solutions for safe transfer of fluids

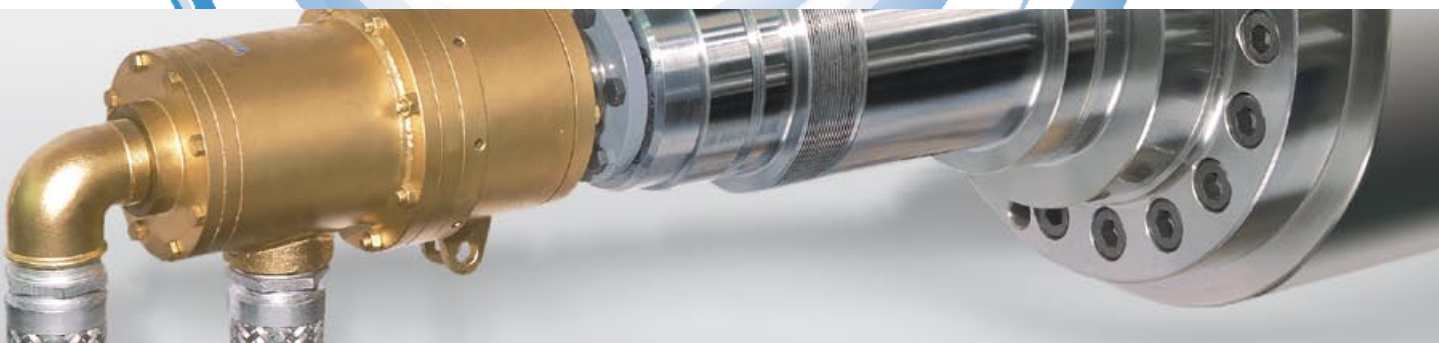



Our Solutions at a Glance

This overview illustrates the benefits, application areas and performance ranges of the Maier rotary joints.

Series

DA	DC	DP	DQ	DX
Shaft-supported rotary joint with maintenance-free, metal-impregnated sealing rings.	Rotary joint for hot water and steam at high pressures and speeds. Balanced mechanical seal with external water cooling. Meets the special requirements of paper and fleece calendars, fiber and corrugated cardboard systems. Suitable for large, steam-heated driers. Patented system.	Universal rotary joint for water and thermal oil with balanced mechanical seal and ball bearings. Various seal combinations can be selected, depending on the application. Meets the special requirements of the printing and plastics industries.	Rotary joint for thermal oil with high temperature and speed ranges, balanced mechanical seal. DQ, DQT, DQTX with additional cooling circuit for cooling and lubrication of bearings and seal. Meets the requirements of calenders operating at high speeds and temperatures. Patented system.	Universal rotary joint for water, equipped with mechanical seal and ball bearings. DXS with highly resistant, ceramics-coated sealing surface for higher temperatures and speeds as well as prolonged service life.

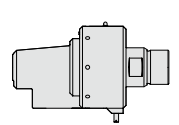
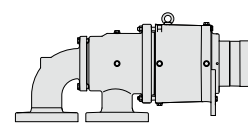
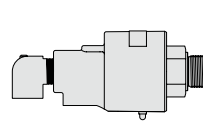
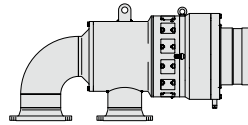
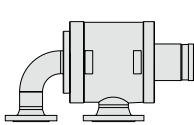

Series	DA	DC		DP		DQ				
Type		DC	DCL	DP	DP-800	DQL	DQ	DQT	DQTX	DQ5
Medium										
Cooling water	●			●						
Hot water	●		●	●						
Steam	●	●								
Cooling lubricant										
Air										
Vacuum										
Hydraulic oil										
Thermal oil	●				●	●	●	●	●	●
Dry-run										
Minimal quantity lubrication										
Operating conditions										
PN max (bar)	40	40	16	10	10	10	10	10	13	10
T max (°C)	320	250	180	160	160	230	300	350	400	300
Speed max...min ⁻¹	$\frac{100000}{DN \times PN}$	$\frac{1000000}{DN \times PN}$	$\frac{1000000}{DN \times PN}$	$\frac{55000}{DN}$	$\frac{55000}{DN}$	$\frac{50000}{DN}$	$\frac{100000}{DN}$	$\frac{100000}{DN}$	$\frac{100000}{DN}$	$\frac{130000}{DN}$
DN (mm) min...max	50–300	25–370	25–150	10–100	10–100	25–125	25–200	25–150	25–150	
Technical specifications										
Catalog number	D144	D143	D143	D132	D132	D134	D134	D134	D134	D134

DZ

Rotary joint series for compressed air. Several channels for different pressures, large and small volumes. Stainless steel version with special sealing rings and counter surfaces made of ceramics or other hard materials. Extremely resistant.

H

Universal rotary joint with maintenance-free carbon sealing rings and carbon bushings. Metal-impregnated sealing rings for thermal oil and higher pressure loads when used for hot water and steam. H3 features an integrated vacuum valve for steam cylinders. Many different versions.

K

High-performance series for internal supply of cooling lubrication (coolant) to machine tools. Suitable for permanent dry-run and for minimal quantity lubrication. Patented system.

M

Sturdy rotary joint for polluted media at low speeds.

MP

Multi-passage rotary joint for simultaneous supply of up to ten different media. For turntables, tools and forms.

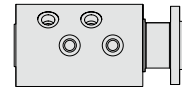
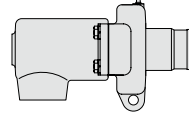
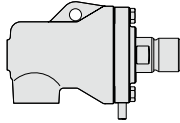
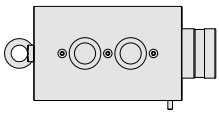

DX			DZ	H		K	M	MP
DX	DXS	DX-Special		H	HW			
●	●	●		●	●		●	●
	●			●	●		●	
				●	●		●	
			●			●		●
	●	●	●					●
		●			●			●
						●		
						●		
8	10	8	40	20	40	80/120	20	200
80	150	120	20	250	320	40	160	80
<u>50000</u> DN	<u>55000</u> DN	Upon inquiry	30	<u>50000</u> DN*PN	<u>100000</u> DN*PN	16000/24000 /36000	<u>8000</u> DN	200
10-80	10-200	...150	200	15-100	25-300	3-10	15-100	
D146	D146	D146		D145	D145	D147	D144	D142

● suitable

Primary Choice in Many Industries



Dear Reader,

Superior and proven product and service quality, safety and reliability as well as a track record of more than 80 years of experience since the foundation for our technology leadership in the area of rotary joints. Our formula of success for optimum rotary joint solutions: extensive research and development, combined with solid laboratory and field testing - for maximum machine and system performance in a great variety of industries.

We provide many lines of products, more than a thousand standard types and numerous special solutions which safely connect pressurized pipes and rotating systems – for heating or cooling with water, steam or thermal oil, for the passage of cooling lubricants or for controlling production processes with hydraulic oil or compressed air. Our products are available worldwide via our representations and a wide spread dealer network.

With this brochure we invite you to take a tour of our company and provide you with an overview of our range of products and services. If you need more information, visit our website at www.maier-heidenheim.de or contact us directly.

Erich Maier.

Erich Maier
CEO, Managing Director, Christian Maier GmbH & Co. KG

Maier Rotary Joints – Solutions for safe transfer of fluids.

Plastics industry
Paper industry
Chemical/pharmaceutical industry
Food industry
General machine construction
Textile industry
Machine tools

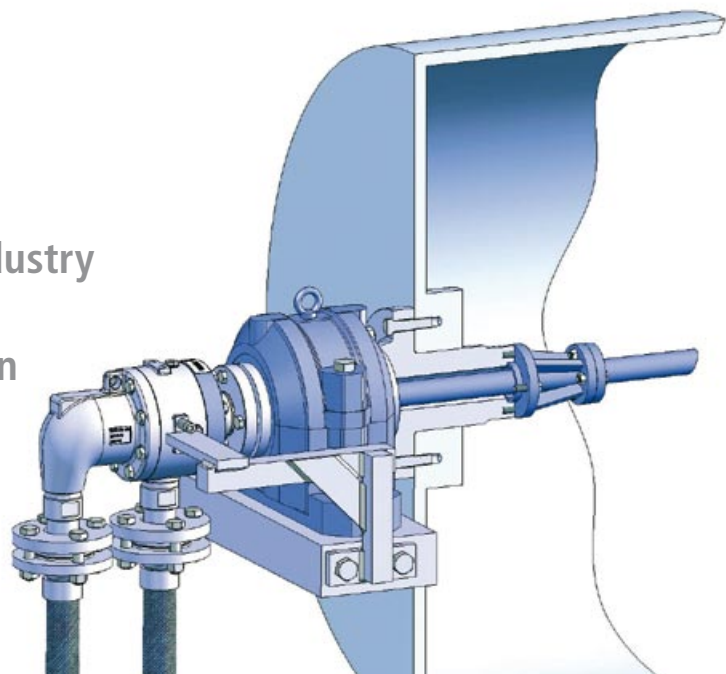

A Great Variety of Rotary Joint Solutions for Many Applications

Whether plastic, paper or food, whether low or high speeds – our wide range of rotary joints offers solutions for many applications. For example, our pressure-dependent designs with slide bearings are maintenance-free with limited speeds. Pressure-relieved solutions with balanced mechanical seals and ball bearings - such as series DX and DP rotary joints – allow considerably higher speeds. Series DQ and DC feature special sealing technologies and allow for high speeds and temperatures.

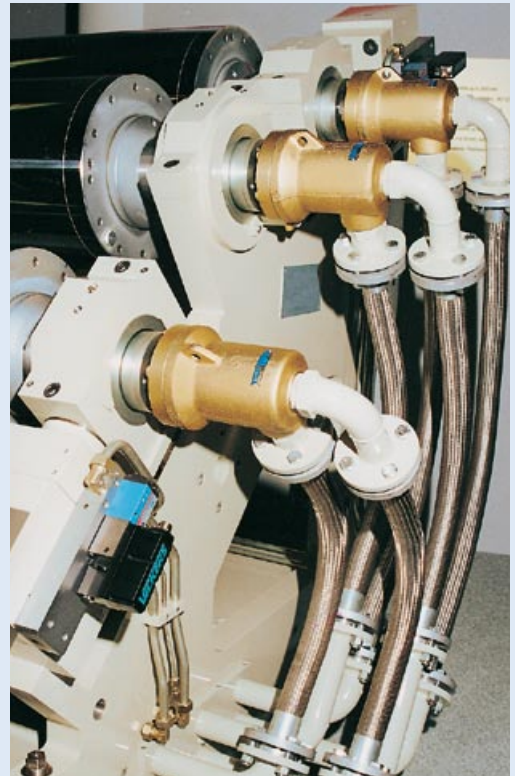
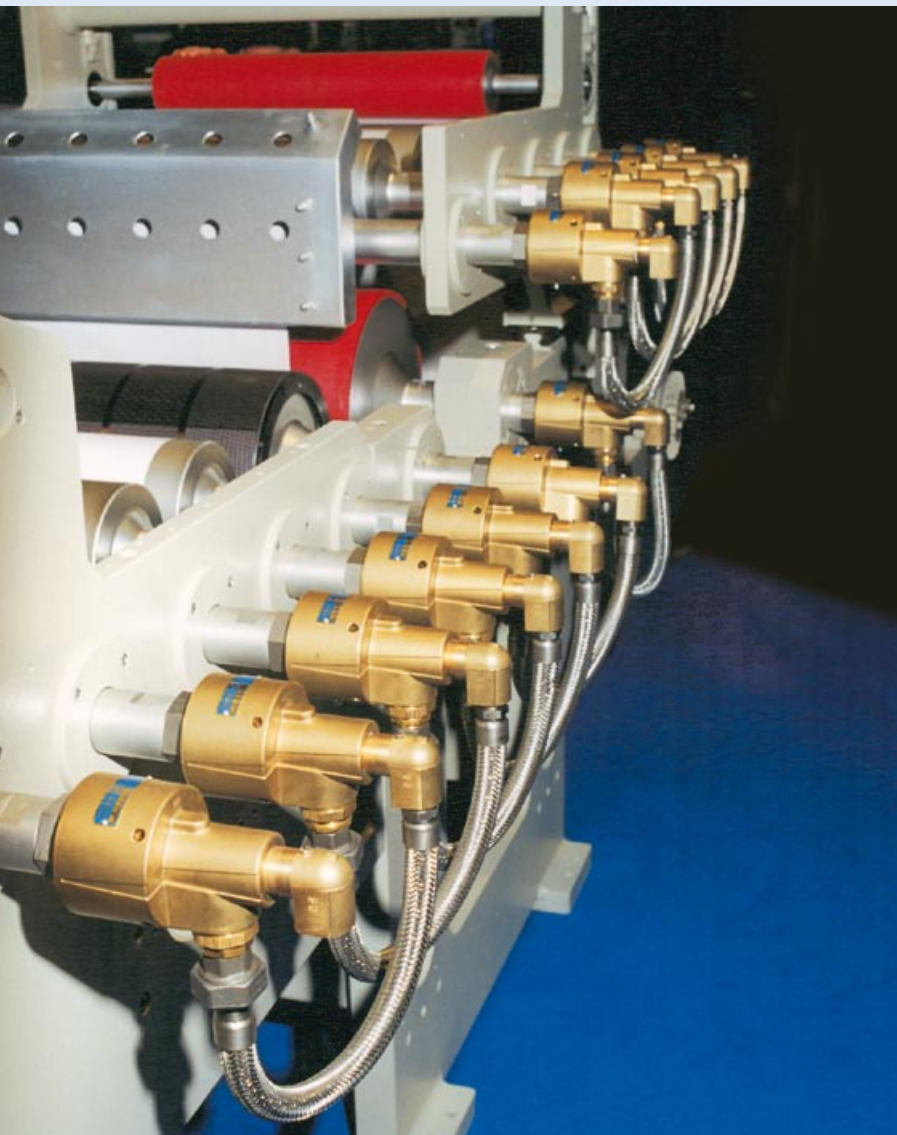

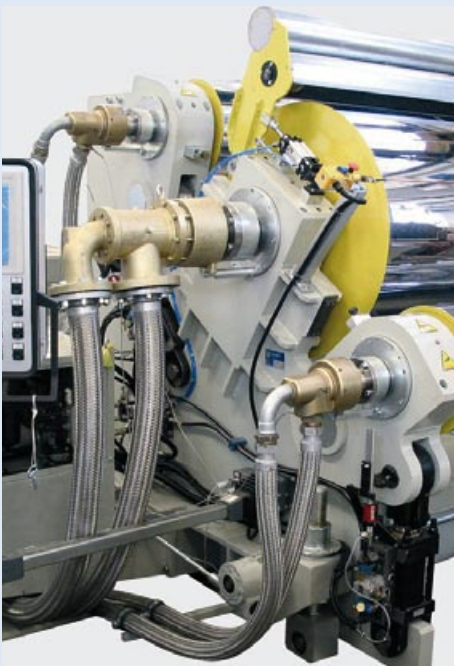
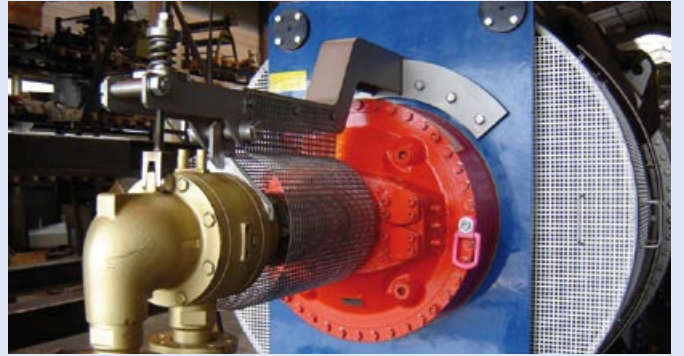
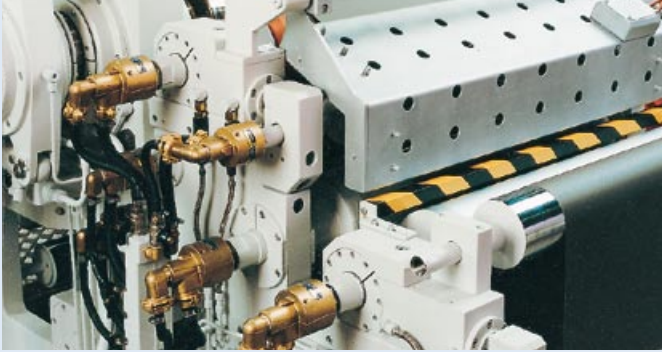

Proven Competence in Many Areas

The competence of our staff is the result of decades of experience in the development and production of rotary joints. Competence takes centre stage at Maier Heidenheim – it is the driving force for our staff members and is reflected in the products we manufacture and the services we provide. The installation of our rotary joints adds this competence to your company – contributing to your success.

Quality

High-grade materials for steel, cast and drop forged parts, bearings and seals as well as state-of-the-art machining centres, measuring systems and devices, assembly lines and test equipment ensure the superior quality of Maier rotary joint solutions.



Certification

Our products comply with many standards to ensure maximum safety.

Reliability

Our customers trust in the reliability of our products and staff. Our rotary joints exceed standard service life in the field by a wide margin, and we enjoy decades of customer loyalty.

Fast Delivery

Good products = satisfied customers? This is just one part of the equation. Added availability and fast delivery achieve real satisfaction. At Maier Heidenheim all processes are streamlined to ensure rapid delivery. If necessary, we deliver within 24 hours.



Worldwide Service

Our customers appreciate our comprehensive and competent service, if desired on site at your location.

Development from Practical Experience for Professional Use

We listen to our customers and understand their needs, starting at development, all the way through to service. A pragmatic oriented development in our own laboratory in close cooperation with the design department is prerequisite and a guarantee for customer-oriented developments and adaptations.

In our fully equipped development centre, we run computer controlled simulation programs on numerous test benches for long-term endurance testing of our rotary joints; with water and steam up to 40 bar and 250 degrees Celsius, with thermal oil up to 350 degrees Celsius, with hydraulic oil up to 200 bar and compressed air up to 80 bar, with cooling lubricant up to 120 bar and 40,000 rpm. Statistical evaluation programs verify the data. And what does that mean for you? Maximum safety and reliability in the application of our rotary joints.

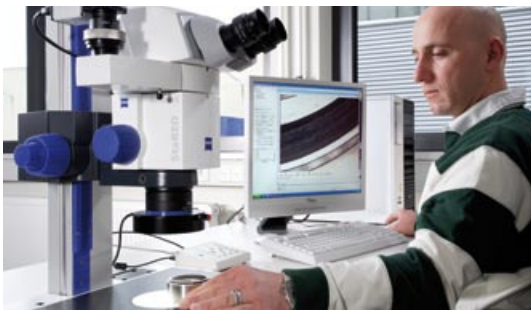

A mechanical seal under the microscope





*R&D laboratory –
heating center for media*



Production with High Manufacturing Quality

The superior manufacturing quality of Maier Heidenheim is the result of many factors. We use highly advanced machining centres equipped with state-of-the-art processes. A staff of highly skilled experts and CNC specialists achieves superior performance with these machines. All critical dimensions are tested with measuring machines and important sealing surfaces are lapped. The units are assembled at special assembly lines. At the end of this process, each rotary joint undergoes a leakage test.



Final assembly line



Measuring machine for quality control



Lapping of sealing surfaces



Machining

Machining centre

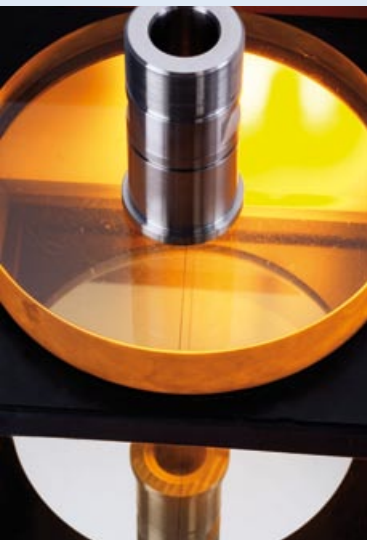

Promptness is Top Priority - Delivery

Fast delivery is essential, especially in case of spare parts requirements. Considering our broad range of products, a comprehensive warehouse is required so that we can deliver "just in time". We stock rotary joints in different nominal sizes as well as various seal combinations and materials. Large parts are stored in a high bay warehouse, small parts in computer controlled racks. The entire shipping process is computer and bar code controlled. This ensures that all parts are readily available and that spare parts or new units are shipped to you on time.

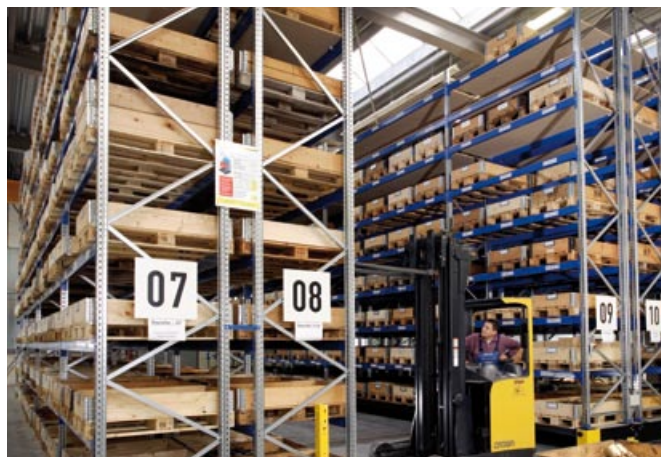

Computer controlled warehouse



Everything under Control - Service

Just like all parts which are subject to heavy mechanical loads, rotary joints must be serviced at regular intervals. Our team of highly skilled service technicians is prepared to provide assistance anywhere round the globe. In case of customized and technologically sophisticated solutions, we recommend to make use of our service offer at your site. Our service specialists are capable of mastering any challenge. Benefit from our flexible service and from the long service life of our rotary joints.

After years of continuous operation, parts which are subject to mechanical load and which have seals and mechanically wearing bearings must also be repaired. The competent Maier Heidenheim repair service includes cost estimates prior to repair and precise handling of the repair orders. Repairs are channeled into the regular assembly process. This ensures a one hundred percent control of the completed repairs. The bonus: We honor the same warranty for a repaired rotary joint as for a new product.



Our service team

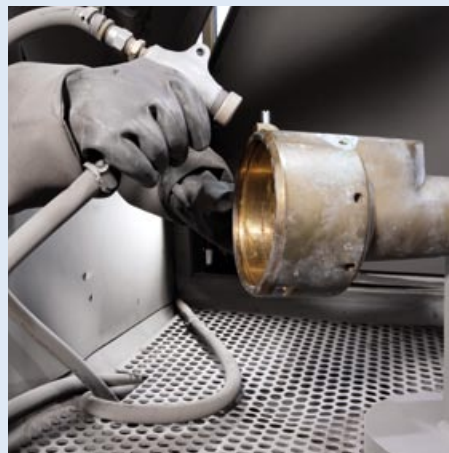

Repair workstation



Safety Guaranteed – Certification

You can fully rely on our products: all rotary joints provided by Maier Heidenheim fully comply in design and manufacture with the European Pressure Equipment Directive 97/23/EC. We are certified as manufacturers according to the German AD2000-HP0 (Association for Pressurized Vessels) and TRD201 (Technical Directive for Steam Boilers) in connection with DIN EN 729-3. Prerequisite for this accreditation is quality management as per ISO 9001. Products up to category three are available with TÜV (third party) certificate and declaration of conformity.

Upon request we also deliver solutions which comply with the standards of the Canadian Standards Association (CSA) – we are approved according to the Canadian "Boiler, Pressure Vessel, and Pressure Piping Code".



ATEX directives are European directives for explosion protection. In particular in the chemical industry certain systems not only require electrical, but also mechanical explosion protection according to ATEX directive 94/9/EC. Rotary joint solutions by Maier Heidenheim meet these requirements as well. Some standard series such as DX and DP are approved according to ATEX directive EX II 2G T3. If required, we provide custom designed rotary joints for you according to the EX protection group D (dust) with respective certification.

maier
heidenheim



Type

FW 280 K

DN(mm) 80

PS(bar) 20/10/1

PT(bar) 30.5

TS(°C)

Fabr.-Nr.

CHRISTIAN MAIER GMBH & CO
D - 89520 HEIDENHEIM
www.maier-heidenheim.de

Baujahr

**Christian Maier GmbH & Co. KG
Maschinenfabrik**

Wuerzburger Straße 67-69
D-89520 Heidenheim, Germany

P.O.Box 1609
D-89506 Heidenheim, Germany

Phone +49 7321 317-0
Fax +49 7321 317-139 (Export)
Fax +49 7321 317-239

vkd@maier-heidenheim.de
www.maier-heidenheim.de

Branch Offices & Service Stations:

Maier Italia Srl

Via Enrico Toti 3
I-21040 Gerenzano (VA), Italy

Phone +39 02 96248288
Fax +39 02 96369695

info@maier-italia.com
www.maier-italia.com



Maier America LLC

6649 Peachtree Industrial Blvd., Suite O
Norcross, GA 30092 - USA

Phone +1 770 4090022
Fax +1 770 4090069

info@maieramerica.com
www.maieramerica.com



novasys group pty ltd

po box 1150 mountain gate 3156 australia
31/756 burwood hwy ferntree gully 3156 australia
t: +61 3 9752 3766
f: +61 3 9752 3977
email: sales@novasys.com.au
website: www.novasys.com.au

