

Leading
Interactive
Playground manufacturer

playNETIC



← All our products are



Playnetic, playing with energy!

We learn while playing, by trial and error!
Playing is an essential part of childrens development.
The Playground is the ideal place to just be a child, the place to grow up!
Get children outdoors again!

With the development of fun interactive outdoor play equipment, we get children exercising again. That is our mission and that's what we are good at!
Playnetic develops and manufactures sustainable interactive play equipment which is sold to dealers all over the world.

Have you played outside before on interactive play equipment?
In all likelihood, it was made by Playnetic!

AudioNetic

Page 4

MusicBall / **Story**Ball

Page 8

KineticWheel

Page 12

DJ Post

Page 16

JumpStone

Page 20

GameNetic

Page 24

AudioZone

Page 28

Connect-IT

Page 32

AudioSense

Page 36



Great games
that stimulate
exercise and collaboration

AudioNetic



Our AudioNetic is





i Makes it
fun to play
Stimulates *exercise*

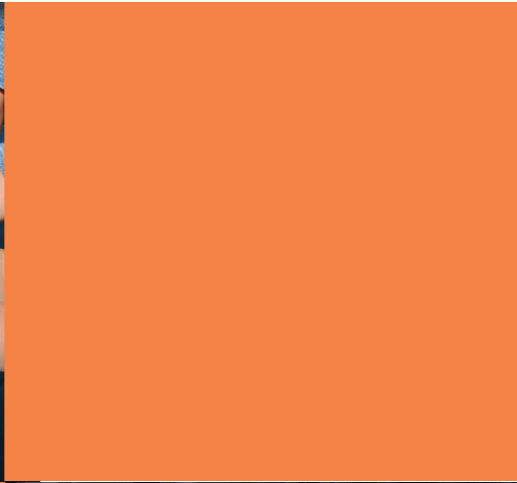

i Makes **you** laugh
really loudly

How does it work?

Great games that stimulate exercise and collaboration!

By pumping the foot pedal children generate energy. Powered up? Press the push button and a selection of games will follow.

The AudioNetic randomly selects a game! All commands are focused on physical movement and interaction.

Hopscotch, tag, hide and go seek, everything is covered. Did you know that there are over 50 different variants of tag?!

Want to laugh? There are also jokes and riddles included! Laughing is super healthy!

With Professor Yellowsnow you will become aware of many interesting scientific facts. Move, listen, learn and have lots of fun!

The AudioNetic comes with a USB stick full of fun!
Other audio? Or your own (recorded) audio?
Simply change the USB stick!

Human Powered

- No external power
- Easy to install
- Durable
- Safe

Audience:	4+
Certification:	NEN EN1176-1:2008
Height:	908 mm
Diameter:	300 mm
Weight:	23 kg

User friendly:	✓
Registration use:	✓
Human powered:	✓
Audio:	✓
Time lock:	optional

Where?

- Schoolyard
- Playground
- Camping

- Playfield
- Amusement parks
- Swimming pool

Every public space

Safety zone should be at least 150 cm



High quality, durable coating, high quality materials



Do you
want to
dance *and* **sing?**

MusicBall



Our MusicBall is





i

Sing along
as loud as
you can



i

Dance
Wildly

How does it work?

This playful Ball is super durable, because by turning the hand crank children will generate energy by themselves! The USB stick determines whether you purchase a MusicBall or StoryBall.

MusicBall:
After you turn the crank, the Music Ball will play well-known children's songs, so everyone can sing along. An essential element in the development of children is in fact music. Music helps the development of physical, emotional, social and cognitive skills. The MusicBall will make you want to dance and sing, so it's a cheerful way for children to develop!

Singing and dancing are more than just fun!

StoryBall:
By listening your imagination is activated. Fantasy makes flexible thinking possible, which creates an imagination. Imagination is the basis for inspiration, new ideas and development.

The MusicBall & StoryBall are available in different colours.

Human Powered

No external power
Easy to install
Durable
Safe

Audience: 3+
Certification: NEN EN1176-1:2008
Height: 635 mm
Diameter: 395 mm
Weight: 28 kg

User friendly: ✓
Registration use: ✓
Human powered: ✓
Audio: ✓
Time lock: optional

Where?

Schoolyard
Playground
Camping

Playfield
Amusement parks
Swimming pool

Every public space

Safety zone should be at least 150 cm

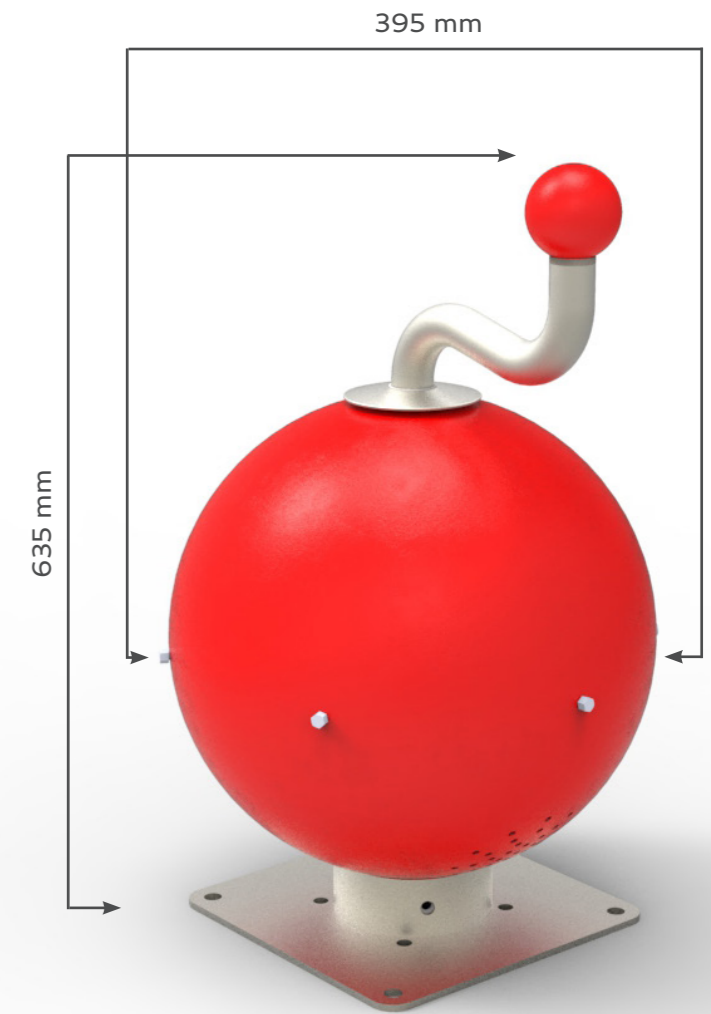

High quality, durable coating, high quality materials



Spin the wheel
and you will
generate electricity

KineticWheel



Our KineticWheel is





i

Interactive outdoor Games



i

Experience and pleasure

How does it work?

Spin the wheel and energize the KineticWheel. You will (randomly) hear an audio clip full of experience.

All three of the steering wheel variants come with a USB stick with their own sound! Always wanted to be a pilot? Sail the seas like a pirate? Experience the feeling of a driver in the cockpit? It's all possible by using the KineticWheel.

These steering wheels are also very nice as a addition to an existing playset. The KineticWheel comes with a wooden steering wheel.

Would you rather play your own sound on the USB stick? Then simply record your own MP3 file(s)!

Available with one specific steering wheel or all three steering wheels in one set!

Human Powered

- No external power
- Easy to install
- Durable
- Safe

Audience:	3+
Certification:	NEN EN1176-1:2008
Height:	1000 mm
Width:	300 mm
Weight:	42 kg

User friendly:	✓
Registration use:	✓
Human powered:	✓
Audio:	✓
Time lock:	optional

Where?

Schoolyard
Playground
Camping

Playfield
Amusement parks
Swimming pool

Every public space

Safety zone should be at least 150 cm

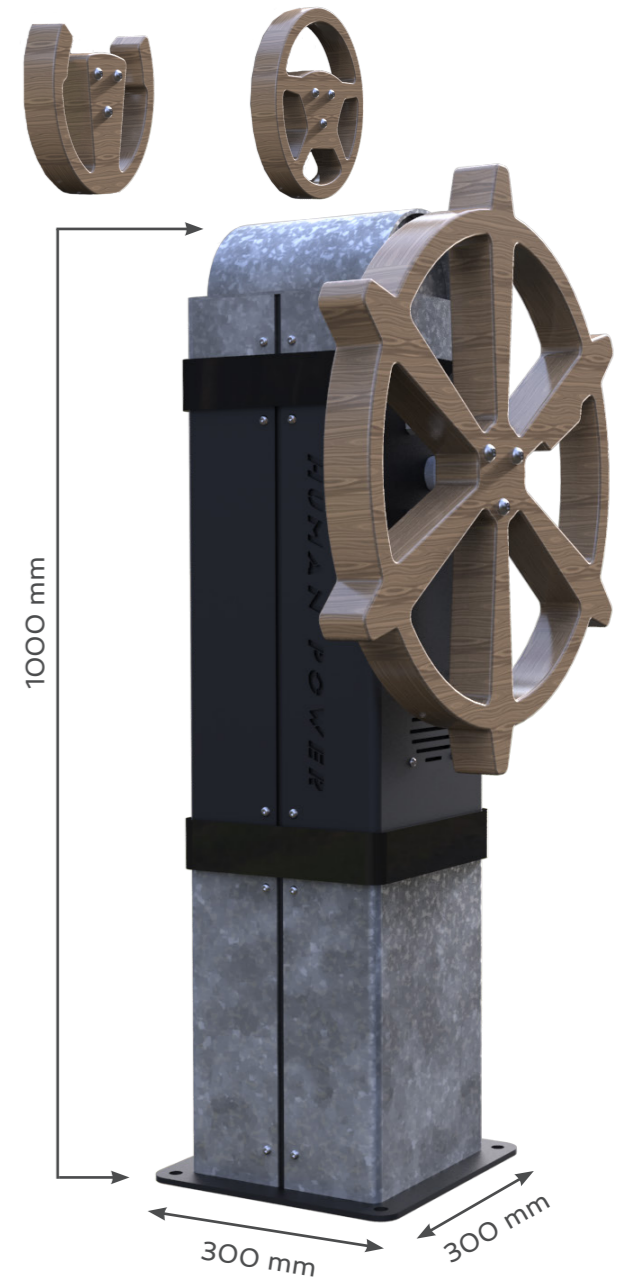

High quality, durable coating, high quality materials



Listen to your
own music in your
favourite hangout

DJ Post



Our DJ Post is





i

Amplify
your
Smartphone



i

No cables
no electricity
necessary

How does it work?

Turn the disc, keep turning! This generates energy. Put your phone on loudspeaker and put it in the designated area, under the protective hood.

The DJ Post amplifies the sound from your Smartphone!

No Bluetooth, no cables! The built-in tech picks up the sound of your Smartphone automatically.

It is always nice to listen to your own music. Every hangout needs one!

Solid? Without a doubt the most solid product we have. Afraid of (noise) disturbance? Not necessary! The DJ Post comes with a time lock.

Human Powered

- No external power
- Easy to install
- Durable
- Safe

Audience:	10+
Certification:	EN 1176-7:2008
Height:	975 mm
Width:	300 mm
Weight:	50 kg

User friendly:	✓
Registration use:	✓
Human powered:	✓
Audio:	✓
Time lock:	optional

Where?

Schoolyard
Playground
Camping

Playfield
Amusement parks
Swimming pool

Every public space

Safety zone should be at least 150 cm

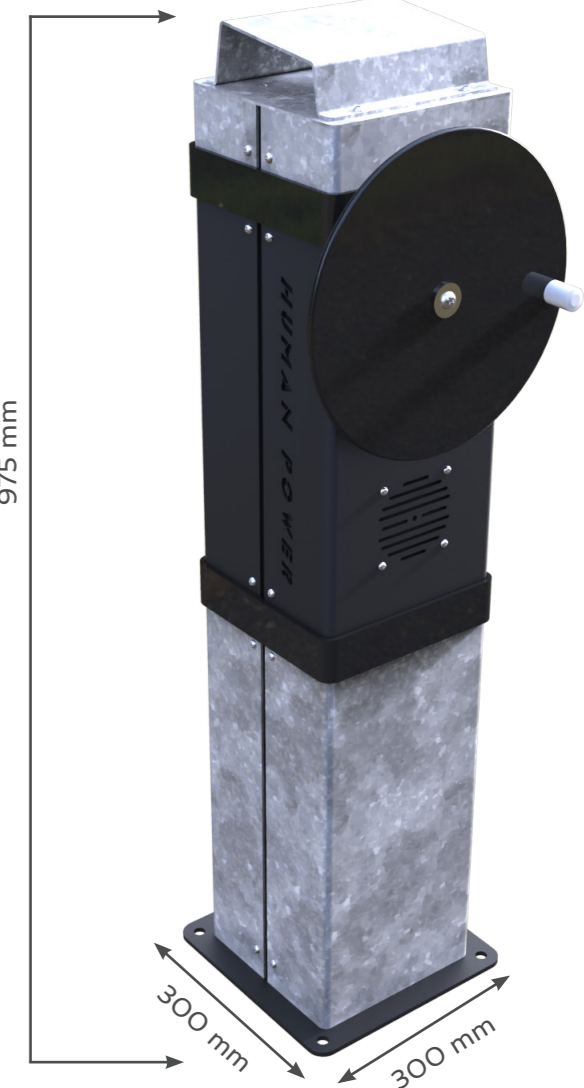

High quality, durable coating, high quality materials



By jumping
you will
generate electricity

JumpStone



Our JumpStone is





i

Very intensive Exercise

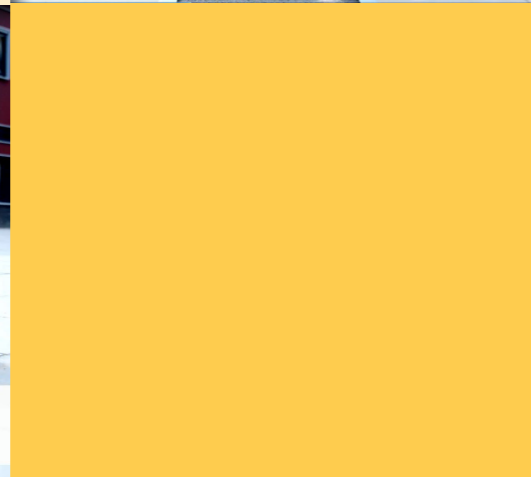

Digital Sound quality

How does it work?

By jumping, you will generate energy and a randomly selected song will play.

You have to keep jumping in order to let the audio continue. Very intense, but luckily you have time to swap with someone to keep the songs going.

Jumping is a very intensive form of movement and contributes to an improved condition and coordination.

Studies have shown that music is not only fun but also stimulates your intelligence and will reduce concentration problems.

The JumpStone comes with a collection of American children's songs.

Human Powered

- No external power
- Easy to install
- Durable
- Safe

Audience:	3+
Certification:	NEN EN1176-1:2008
Height:	252 mm
Width:	511 mm
Weight:	35 kg

User friendly:	✓
Registration use:	✓
Human powered:	✓
Audio:	✓
Time lock:	optional

Where?

Schoolyard
Playground
Camping

Playfield
Amusement parks
Swimming pool

Every public space

Safety zone should be at least 150 cm



22

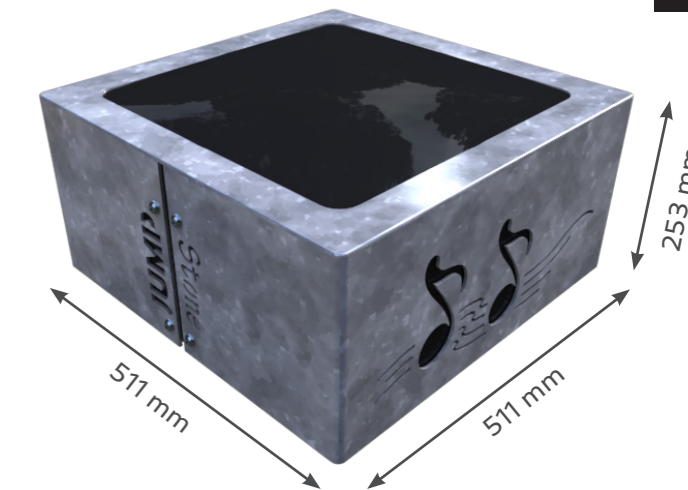

High quality, durable coating, high quality materials



Outdoor
gaming at
its best

GameNetic

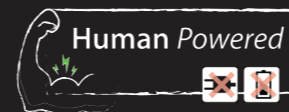

Our GameNetic is





Outdoor gaming



Challenging and Cool games

How does it work?

Let's start with a workout! Keep working the foot pedal until the GameNetic tells you to stop. Now, "let the games begin!"

The GameNetic is a game console designed specifically for the public space. The pillar, provided with a foot pedal, two buttons and a display, is very safe and user-friendly.

The score is obtained and determined by a clever combination of reaction time and the number of correct answers. This makes the GameNetic suitable for children within the age group of 8 to 12 years.

The constantly varying questions and tasks provide long-lasting fun. Speed, memory and numeracy skills are all covered. The combination of light and sound will make children experience the real game feeling. Outdoor gaming at its best!

The GameNetic comes with 4 interactive games, and now...
CHECK YOUR HIGH SCORE!

Human Powered

- No external power
- Easy to install
- Durable
- Safe

- Audience: 8+
- Certification: NEN EN1176-1:2008
- Height: 908 mm
- Diameter: 300 mm
- Weight: 23 kg

- User friendly: ✓
- Registration use: ✓
- Human powered: ✓
- Audiovisual: ✓
- Time lock: optional

Where?

- Schoolyard
- Playground
- Camping

- Playfield
- Amusement parks
- Swimming pool

Every public space

Safety zone should be at least 150 cm



26

High quality, durable coating, high quality materials



Play the
game with
the sidekicks

Audiozone



Our AudioZone is





Four sidekicks
are you
fast enough?

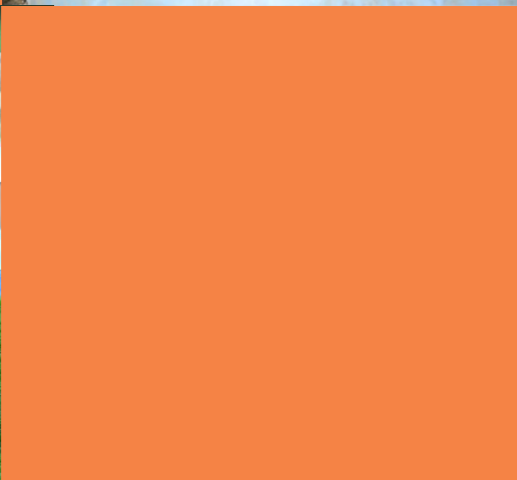

Test your
Reaction *time*

How does *it work?*

Turn the crank and energize the AudioZone. Did you generate enough electricity? Then you can play the game using the sidekicks.

Do you know the right answer? Then sprint to the illuminated sidekick and kick it. Using your hands, feet, with a ball or whatever you come up with.

4 games included: memory, speed test, the BOMB, and.....

These 4 different games will test
your skills to the max!

Human *Powered*

No external power
Easy to install
Durable
Safe

Audience: 6+
Certification: NEN EN1176
Height crank: 635 mm
Height sidekick: 215 mm
Diameter crank: 395 mm
Diameter sidekick: 395 mm
Weight: 90 kg

Registration use: ✓
Audiovisual: ✓
Time lock: optional

Where?

Schoolyard
Playground
Camping

Playfield
Amusement parks
Swimming pool

Every public space

Safety zone should be at least 150 cm

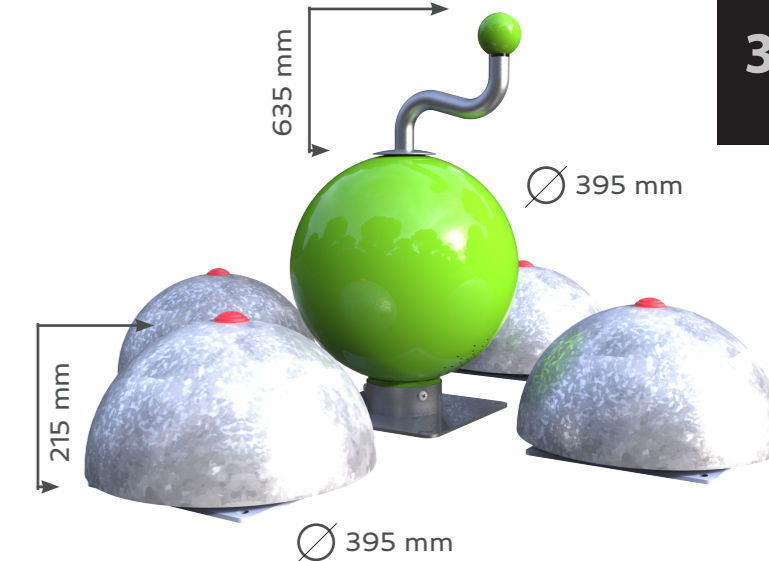

High quality, durable coating, high quality materials



Press the button
and
start chatting

Connect-IT

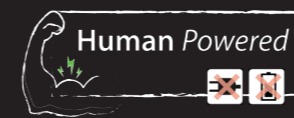

Our Connect-IT is





i

Connection Sharing Secrets?



i

Together by remote control



How does it work?

Do you wish to chat too? With the Connect-IT, you generate electricity by turning the hand crank. Press the button and start chatting.

Tell fun interesting facts, jokes or secrets, it's all possible!
Give each other tasks and see what happens....

Have you finished your story and do you want to hear what your friend has or friends have to say? Don't forget to end with the words 'over and out'.

Do you want to let several Connect-IT's communicate with each other? No problem!

Curious about how far the Connect-IT can reach?
Up to 1 kilometre!

Human Powered

No external power
Easy to install
Durable
Safe

Audience: 5+
Certification: NEN EN1176-1:2008
Height: 1084 mm
Diameter: 220 mm
Weight: 35 kg

User friendly: ✓
Registration use: ✓
Human powered: ✓
Audiovisual: ✓
Time lock: optional

Where?

Schoolyard
Playground
Camping

Playfield
Amusement parks
Swimming pool

Every public space

Safety zone should be at least 150 cm

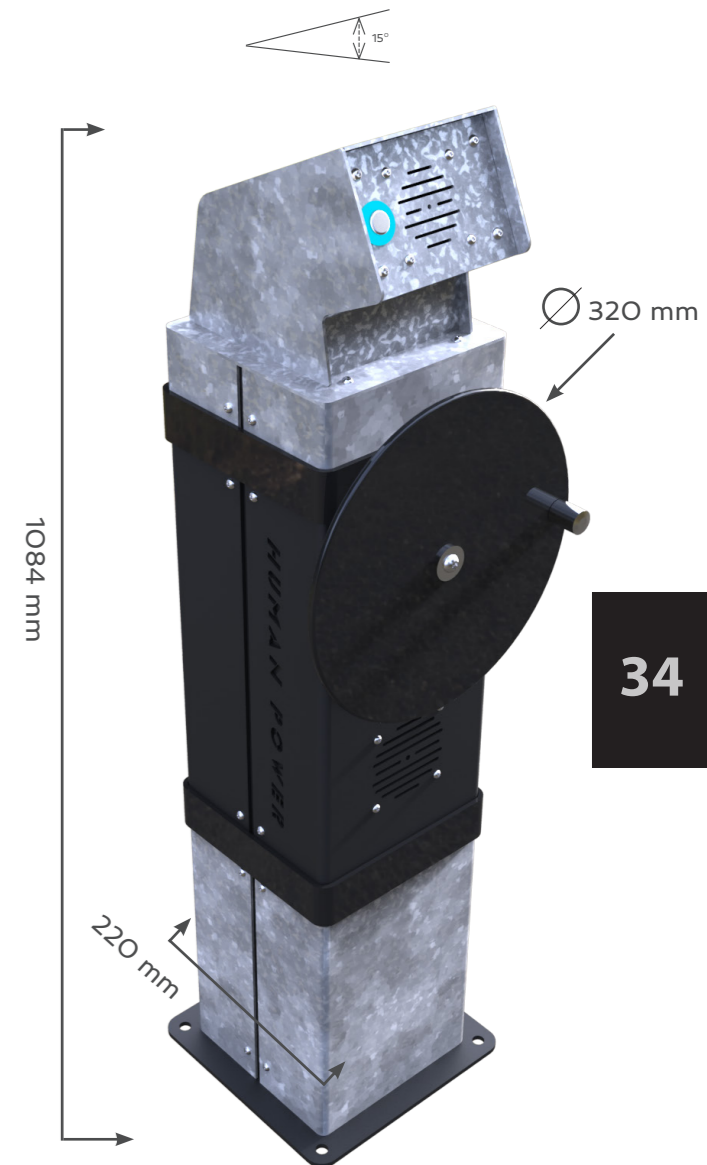

34

High quality, durable coating, high quality materials



Sound and smell
stimulate all
Your senses

AudioSense



Our AudioSense is





i

Smell
Sounds
Senses

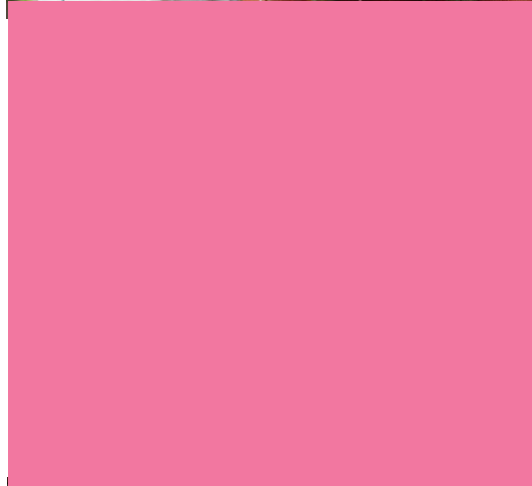

i

Use your
own
imagination

How does it work?

Spin to generate electricity! No batteries, no external power supply! Human powered! The AudioSense is specially designed for outdoor use: wind, rain, sun and snow proof!

Music, stories, sounds, whatever you like!
Unbelievable sound quality!

Tip:
Use this AudioSense as a stand-alone item, add it to an existing play structure or design your own concept!

You won't believe this:
The AudioSense is equipped with a smell generator!
You can choose one of the existing smells we offer.
You can also change it into any smell you desire.

You will become the AudioSense with one flavour/smell out of our standard range of odor.

Human Powered

No external power
Easy to install
Durable
Safe

Audience: 3+
Certification: NEN EN1176-1:2008
Width: 170 mm
Diameter: 340 mm
Weight: 23 kg

User friendly: ✓
Registration use: ✓
Human powered: ✓
Audiovisual: ✓
Time lock: optional

Where?

Schoolyard
Playground
Camping

Playfield
Amusement parks
Swimming pool

Every public space

Safety zone should be at least 150 cm

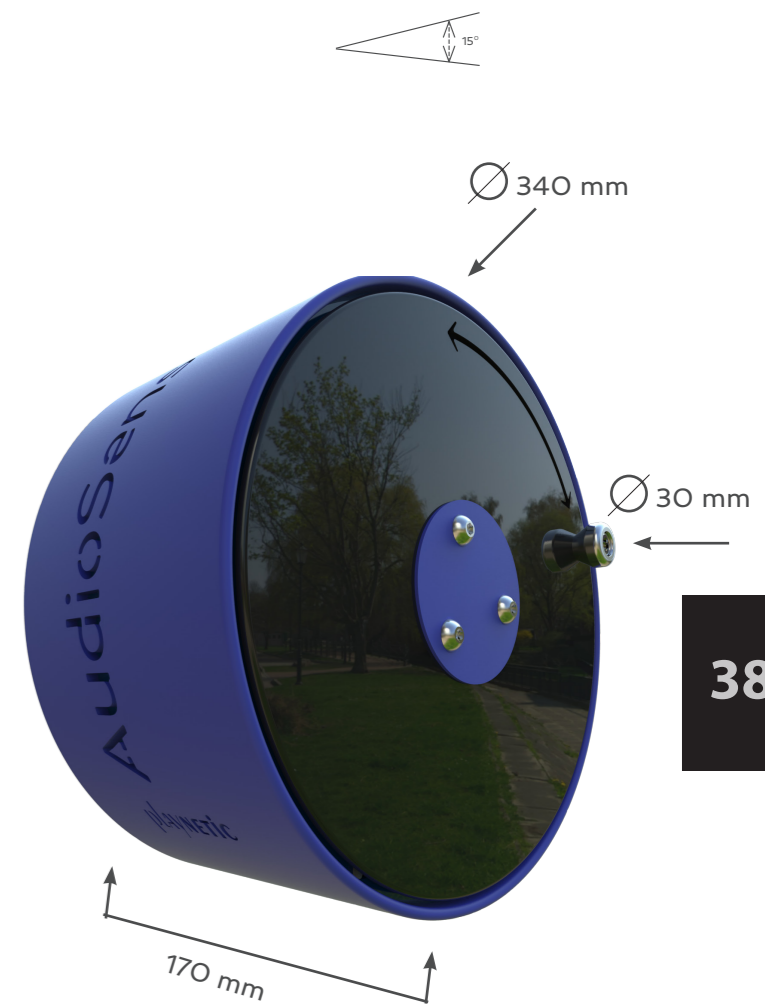

38

High quality, durable coating, high quality materials



“Young children learn the most important things not by being told but by constructing knowledge for themselves in interaction with the physical world and with other children – and the way they do this is by playing.”

(Jones & Reynolds, 1992, p. 1)

