



SUN  
PROTECTION





**5** YEAR  
BRUSTOR-  
GUARANTEE

More info see page 37

INSPIRATION	2
FEATURES AND OPTIONS	6
B24 ELITE, B24 PRESTIGE	8
B25, B25 ELITE, B25 PRESTIGE	10
B27, B27 ELITE, B27 PRESTIGE	12
B35, B35 PRESTIGE	14
B38, B38 PRESTIGE	15
B50	16
B50 XL	17
B34 (XL)	18
B40	19
B20, B21	20
TWINSTOR	21
TOPSCREEN	22
B126	23
B127 VERANDA	24
B128 VERANDA	25
B128 PERGOLA	26
ZIPSCREEN	28
B1100 & B1350 SOLAR SCREEN	30
B1200 ZIP	31
CORNER SCREEN	32
STANDARD SCREEN	33
INDOOR SCREEN	33
B2100 DROP ARM AWNING	34
WINDBLOCKER	35
OPTIONS AND TECHNICAL INFO	37



B38





B25



Create a  
*comfortable atmosphere*  
inside and out





# FEATURES AND OPTIONS

## PERSONALIZE YOUR AWNING

Do you want more comfort or to personalise your awning? Choose from our wide range of options. For example add some LED lighting for an atmospheric effect or a patio heater which will warm your guests on cooler evenings. Or increase the shading on your patio by adding an extra valance.

You can add your ultimate personal touch by choosing your favourite colour for your awning. Beside the standard colours, it's possible to choose from every available RAL colour. Perfectly adapted to your home and garden. Finally, you can also choose from some practical options like a remote control, ceiling fix brackets, wind protection or lead rail support for an instant added value!



CHOICE OF ARMS	STANDARD	ELITE	PRESTIGE
Max. load elbow	100 kg casted alu parts	105 kg casted alu parts	130 kg alu in drop forged alu parts
Height of the arm	66 mm	71 mm	73 mm
Thickness of profile	2,5 mm	2,5 mm	3 mm
Wind resistance	till 39 km/h	till 39 km/h	till 49 km/h
Possible for	B21, B25, B27, B50	B24, B25, B27 Elite, B35, B38, B50 XL	B24, B25, B27, B35, B38 Prestige
LED lighting	beneath the cassette	LED in the upper and lower section of the arm	LED spot in arm elbow

### Choice of retractable arms

No parts are as important as the folding arms. They support the fabric, they roll it in and out and even host LED lights. Wind, large projection: each application has its specific retractable arm.

10 Years Brustor guarantee on the moving parts of the awning.



### Guarantee

- 5 years on the cassette and parts.
- 10 years on the moving parts of the awning.
- 2 years on LED lighting and heaters.

### Lead rail support

(Depending on the type of awning) When the awning is rolled out and the front profile has reached its furthest position, that's the point where the awning faces the downward pulling force the most. In order to give the awning more stability and resistance, two integrated support legs can be optionally mounted.

### Heating

When the temperature drops, a pleasant radiant heat can bring comfort. A 2000W patio heater makes it appealing to enjoy outdoor life until even long after the warm summer days.

### LED lighting

An ambient LED lighting can be added to almost every awning and even lights up your terrace when closed.



### Valance

Sometimes the projection is insufficient to create the desired shadow. An extra valance on the front increases the shadow surface extensively.



### Remote control

Each awning is equipped with a motor that controls the respective parts. You can also control your awnings on your smartphone via Tahoma or Connexoon by Somfy.



### Wide choice of colours

The awnings are available in a range of standard colours. Brustor offers its customers additional choice between all RAL colours.





# B24 ELITE B24 PRESTIGE

Are you searching for a robust awning? The B24 Elite and especially the B24 Prestige will fit your needs. The B24 Prestige is resistant to a wind force of 6 Beaufort and offers shade and shelter under various weather conditions.

B24 Elite and the B24 Prestige are equipped with powerful folding arms fitted with 4 steel cables, providing a shadow range up to 3,75 m. In addition to comfort, these awnings also create an ambient place. And what do you think of optional LED lighting and heating?

**More options and specifications on page 37**

- Elegant finish with aluminum side plates without visible screws
- Fully enclosed cassette for optimal protection during various weather conditions
- Maximum width of 7 m and 14 m when coupled
- Compact and contemporary design



**B24 Elite**

- 4 cables in the folding arms
- Projection up to 3,75 m
- Option: LED strip in upper and lower arm or under the cassette



**B24 Prestige**

- Most robust solution
- Projection up to 3,75 m
- Option: LED spot in elbow of the folding arm or under the cassette

## Dimensions

	B24 Elite	B24 Prestige
Width:	min. 2,05 m - max. 14,00 m (coupled from 7,01 m)	min. 3,49 m - max. 14,00 m (coupled from 7,01 m)
Projection*:	1,50 m - 2,00 m - 2,50 m 3,00 m - 3,50 m - 3,75 m	3,00 m - 3,50 m - 3,75 m
Cassette:	22,0 cm high x 14,7 cm deep	
Operation:	Somfy IO or RTS motor with wireless transmitter	

### Standard colours Elite



All other RAL colours optional.

### Standard colours Prestige

All RAL colours.



B24 ELITE /  
PRESTIGE



B24 ELITE /  
PRESTIGE







Move the luxury  
from inside out

# B25 B25 ELITE B25 PRESTIGE

The B25 family is available in 3 different versions. In addition, you have the opportunity to add a fully automatic valance to the B25 Elite. The B25 series fits any facade because of its compact design.

More options and specifications on page 37

- Elegant finish with aluminum side plates without visible screws
- Maximum width of 14 m when coupled.
- Fully enclosed cassette
- Compact design
- B25 Valance max width 6m



- 5<sup>Bt</sup>** B25 Standard
- 2 cables in the folding arms
  - Projection up to 3 m
  - Option: LED strip under the cassette

- 5<sup>Bt</sup>** B25 Elite
- 4 cables in the folding arms
  - Projection up to 3,75 m
  - Option: LED strip in upper and lower arm or LED strip under the cassette
  - Option: Motorised valance

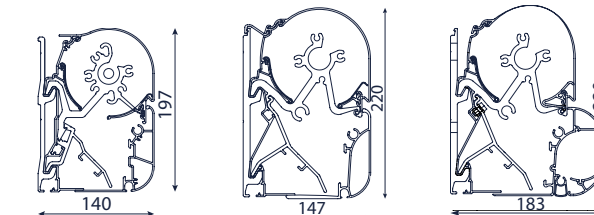

B25 B25 ELITE / PRESTIGE B25 ELITE / PRESTIGE VALANCE

- 6<sup>Bt</sup>** B25 Prestige
- 4 cables and elbow in drop forged alu parts
  - Most robust solution
  - Projection up to 3,75 m
  - Option: LED spot in elbow of the folding arm or LED strip under the cassette
  - Option: Motorised valance

## Dimensions

	Standard	Elite	Prestige
Width:	min. 2,05 m - max. 14,00 m (coupled from 7 m)		min. 3,49 m - max. 14,00 m (coupled from 7 m)
Projection*:	1,50 m - 2,00 m - 2,50 m - 3,00 m	1,50 m - 2,00 m - 2,50 m - 3,00 m - 3,50 m - 3,75 m	3,00 m - 3,50 m - 3,75 m
Cassette:	19,7 cm high x 14,0 cm deep		22,0 cm high x 14,7 cm deep
Operation:	Somfy IO or RTS motor with wireless transmitter		

### Standard colours Standard & Elite



All other RAL colours optional.

### Standard colours Prestige

All RAL colours.



\*Possible projection depends on the width of the awning



# B27 B27 ELITE B27 PRESTIGE

Retractable awnings B27 Standard, Elite and Prestige stand out with their contemporary rectangular shape. All three models are very suitable for modern houses and can also be built into the facade. They are technically identical to the B25 models in Standard, Elite and Prestige. There are five standard colours, while 200 other RAL colours are available as an option to find the colour of your dreams.

More options and specifications on page 37

- Contemporary, rectangular shape
- Can be built into the facade
- Elegant finish with aluminum side plates without visible screws

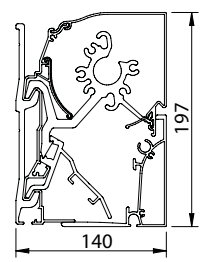

B27

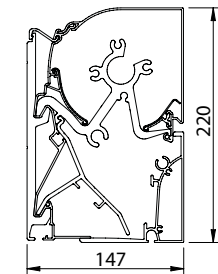

B27 ELITE / PRESTIGE



- 5<sup>Bft</sup>** B27 Standard
- 2 cables in the folding arms
  - Projection up to 3 m
  - Option: LED strip under the cassette

- 5<sup>Bft</sup>** B27 Elite
- 4 cables in the folding arms
  - Projection up to 3,75 m
  - Option: LED strip in upper and lower arm or under the cassette

- 6<sup>Bft</sup>** B27 Prestige
- Most robust solution
  - Elbow in drop forged alu parts
  - Option: LED spot in elbow of the folding arm or LED strip under the cassette

## Dimensions

	Standard	Elite	Prestige
Width:	min. 2,05 m - max. 14,00 m (coupled from 7 m)		min. 3,49 m - max. 14,00 m (coupled from 7 m)
Projection*:	1,50 m - 2,00 m - 2,50 m - 3,00 m	1,50 m - 2,00 m - 2,50 m - 3,00 m - 3,50 m - 3,75 m	3,00 m - 3,50 m - 3,75 m
Cassette:	19,7 cm high x 14,0 cm deep		22,0 cm high x 14,7 cm deep
Operation:	Somfy IO or RTS motor with wireless transmitter		

### Standard colours Standard & Elite



All other RAL colours optional.

### Standard colours Prestige

All RAL colours.





# B35 B35 PRESTIGE

The B35 and B35 Prestige are wind resistant retractable awnings. The Prestige version can resist up to 6 Beaufort, with a projection of 4 meter.

Retractable awning B35 Prestige has been developed with a bar system which meets the highest quality standards (EN 13561). The Brustor B35 can resist to a wind force up to 6 Beaufort and has a projection of 4 m, even when the fabric consist of 15 m in one part. You will be sitting very comfortable under the awning even with a strong wind.

As an option, this awning can be equipped with built-in LED lights and heating. As an alternative for the 5 standard colours, you can choose from 200 optional RAL variations and some hundreds of different high quality acrylic fabrics.

### More options and specifications on page 37

- Strong awning with 4 cables
- Bar system with reinforced support tube
- Maximum width of 15 m when 2 awnings are coupled.
- Up to 4 m extension
- The 'heavy duty' awning



- 5<sup>Bit</sup>** B35
  - The standard gutter profile ensures a better fabric support
  - Option: LED strip in upper and lower arm or under the cassette
- 6<sup>Bit</sup>** B35 Prestige
  - Standard with Somfy RTS or IO motor with remote control
  - Option: LED spot in elbow or under the cassette

The B35 awning is available in several versions, varying from an open system (type A) to a fully enclosed cassette casing (type K). Awning B35 Prestige is available with fully enclosed cassette (type K) or semi-closed (type I).

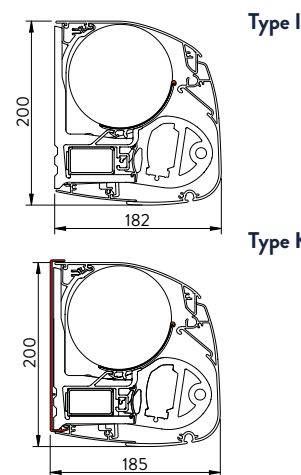

Dimensions		B35 Elite	B35 Prestige
Width:		min. 2,05 m - max. 15,0 m (coupled from 7,5 m)	min. 3,53 m - max. 15,0 m (coupled from 7,5 m)
Projection*:		1,50 m - 2,00 m - 2,50 m - 3,00 m - 3,50 m - 4,00 m	3,00 m - 3,50 m - 4,00 m
Cassette:		20,0 cm high x 18,2 cm deep	
Operation:		IO or RTS motor with transmitter	

**Standard colours Elite**

All other RAL colours optional.

**Standard colours Prestige**

All RAL colours.

\*Possible projection depends on the width of the awning

# B38 B38 PRESTIGE

Are you looking for an optimal protection against the sun, wind or insight? The B38 and B38 Prestige are folding arm awnings that provide a maximum amount of shading. The B38 is an exclusive awning that can resist wind forces up to 6 Beaufort. The variable valance offers a perfect protection against the low sun and offers extra privacy. When not in use, the valance disappears completely into the lead rail. The awning and variable valance can be controlled with one single remote control. Optionally, this remote can also control built-in LED lighting and electric heater.

### More options and specifications on page 37

- Perfect for protection against the low sun or for houses with south-west orientation
- Folding arm awning up to max. 6 m width
- Projection up to 3,5 m
- With roll-up motorised valance up to 1,3 m
- Strong awning with 4 cables



- 5<sup>Bit</sup>** B38
  - The standard gutter profile ensures a better fabric support
  - Option: LED strip in upper and lower arm or under the cassette
- 6<sup>Bit</sup>** B38 Prestige
  - Standard with Somfy RTS or IO motor with remote control
  - Option: LED spot in elbow or under the cassette



Dimensions		B38	B38 Prestige
Width:		min. 2,05 m - max. 6,0 m	min. 3,50 m - max. 6,0 m
Projection*:		1,50 m - 2,00 m - 2,50 m - 3,00 m - 3,50 m	3,00 m - 3,50 m
Cassette:		20,2 cm high x 21,2 cm deep	
Operation:		motor RTS or IO with transmitter	
Valance:		variable, up to 1,30 m	

**Standard colours Elite**

All other RAL colours optional.

**Standard colours Prestige**

All RAL colours.

\*Possible projection depends on the width of the awning

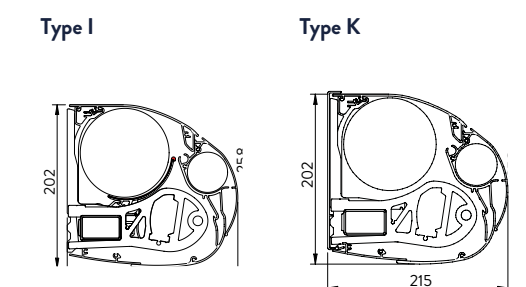



# B50

The Brustor B50 has a compact and fully enclosed cassette casing which excels not only aesthetically but also technically.

The B50 is available up to 5,50 m width, with a maximum projection of 3 m. The awning can easily be mounted by simply hooking the awning into the wall or ceiling fix brackets. With an easy adjustable nut the inclination can effortlessly be altered up to 45°. The B50 can optionally be equipped with a remote control, LED lighting, valance and heating.

More options and specifications on page 37



- Awning up to 5,5 m width
- Easy mounting with wall or ceiling brackets

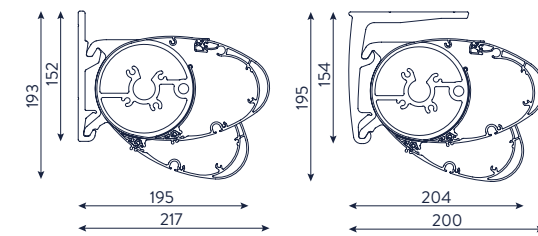

## Dimensions

Width: min. 2,05 m - max. 5,50 m

Projection\*: 1,50 m - 2,00 m - 2,50 m - 3,00 m

Operation: Somfy RTS or IO motor

Cassette: 15,2 cm high x 21,7 cm deep

## Standard colours



All other RAL colours optional.

\*Possible projection depends on the width of the awning



# B50 XL

New generation of awnings with extra strong casing and LED strip under the cassette.

The Brustor B50 XL is the big brother of the compact B50. Thanks to the more robust cassette, the B50 XL is available up to 6 m wide and has a maximum projection of 3,50 m. Add optional LED lighting in the arms or integrated in the cassette for even more atmosphere in the evening.

More options and specifications on page 37

- Extra strong cassette
- Easy assembly with wall or ceiling bracket
- Max. 6 x 3 m or 5,50 x 3,50 m
- Optional LED in folding arms or under the cassette

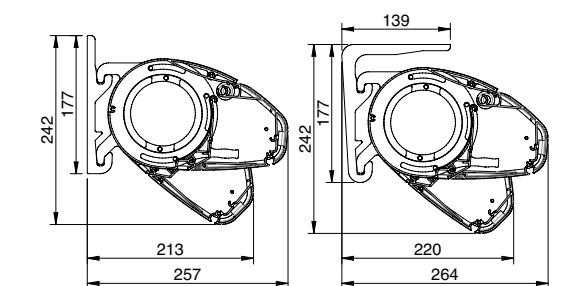

## Dimensions

Width: min. 2,05 m - max. 6 m

Projection\*: 1,50 m - 2,00 m - 2,50 m - 3,00 m - 3,50 m

Operation: Somfy IO or RTS motor with remote control

Cassette: 17,7 cm high x 25,7 cm deep

## Standard colours



All other RAL colours optional.

\*Possible projection depends on the width of the awning

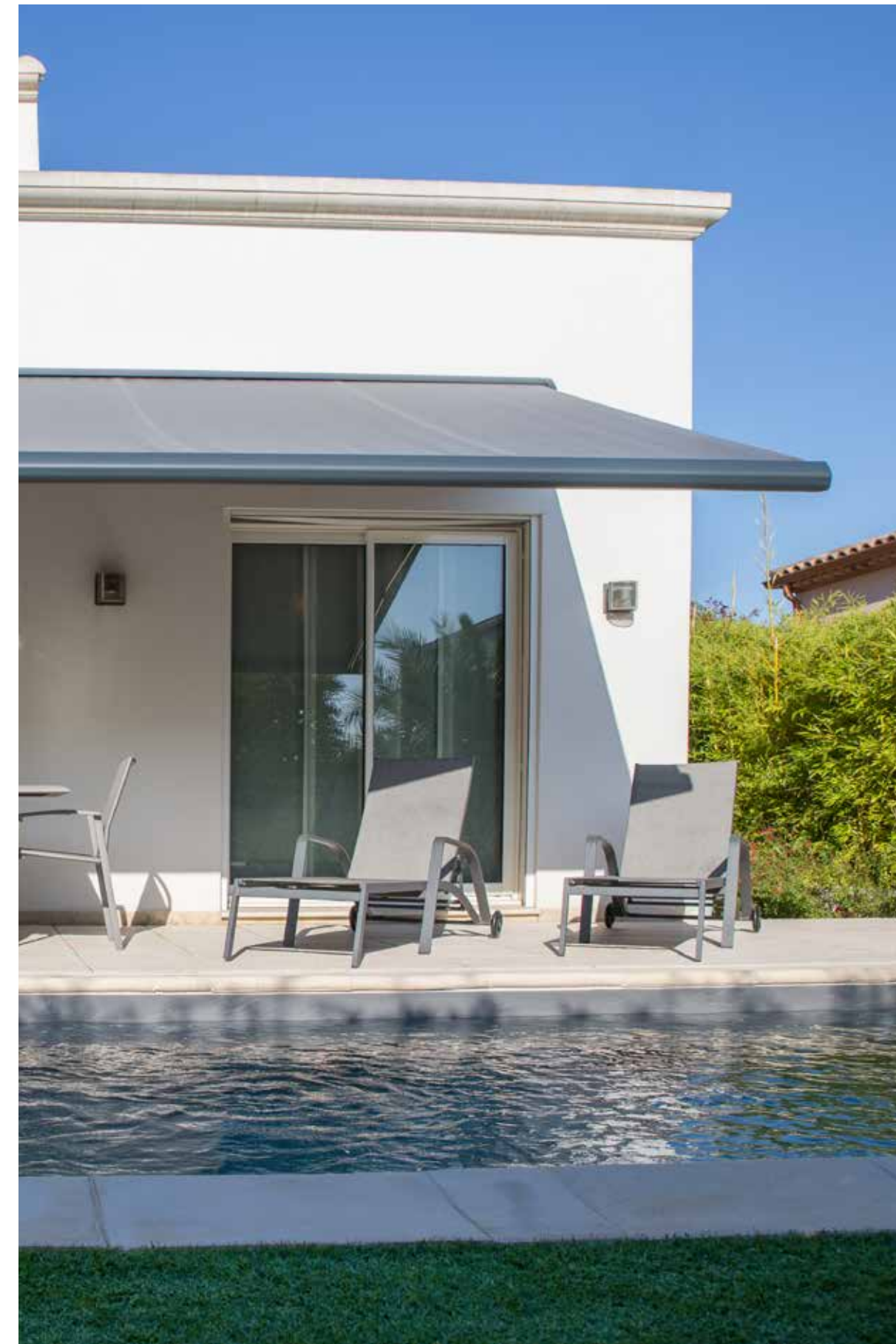





# B34 B34 XL

The B34 is a budget friendly awning with a maximum width of 6 m and projection of 3 m. The integrated tubular motor is standard, but can be equipped with gear operation (optional).

**More options and specifications on page 37**

- Limited width, large projection
- Max. width of 6 m
- Projection up to 3 m

Thanks to the crossed arms it is possible to have a large projection even when the width is limited.

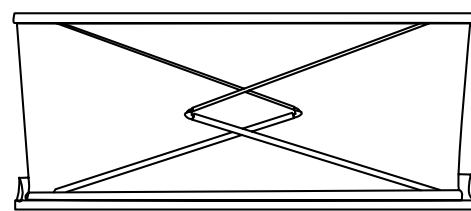

### Dimensions

**Width:** min. 1,25 m with crossed arms - max. 6,00 m

**Projection\*:** 1,50 m - 2,00 m - 2,50 m - 3,00 m

**Operation:** Somfy IO or RTS motor with remote control

**Cassette:** 17,8 cm high x 22 cm deep

### Standard colours



All other RAL colours optional.

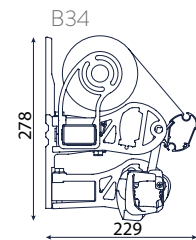
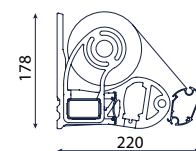

\*Possible projection depends on the width of the awning

# B40

The B40 awning is extremely suitable for the project market. Based upon the B35 family, this awning has a round design. Two types are available: it can be mounted directly to the wall (type I) or with the help of special supports +/- 10 cm from the wall (type K).

**More options and specifications on page 37**

- Folding arms with 4 cables
- Suitable for the project market
- Available in 2 mounting types

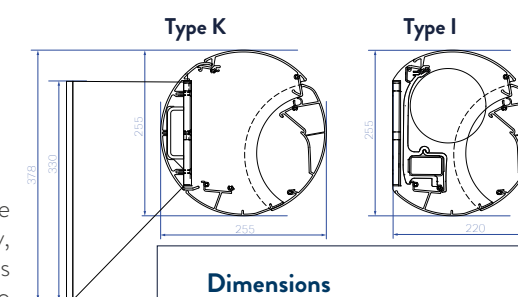

### Dimensions

**Width:** min. 2,05 m - max. 7,00 m

**Projection\*:** 1,50 m - 2,00 m - 2,50 m - 3,00 m - 3,50 m

**Operation:** Somfy RTS or IO motor

**Cassette:** 22,5 cm high x 25,5 cm deep

### Standard colours



All other RAL colours optional.

\*Possible projection depends on the width of the awning



Type K





# B20 B21

Are you looking for sun protection for your balcony? The semi-enclosed cassette awning B20 with retractable arms for ceiling installation is available with an inclination between 5° and 40°. The almost identical B21 can be mounted between 20° and 60°, the ideal solution for more privacy and extra shadow. Both awnings are available with a maximum projection of 3 m and a maximum width of 5,5 m. Because of its compact 13,5 cm height, the cassette of these awnings is extremely suitable to be fitted under a balcony.

More options and specifications on page 37

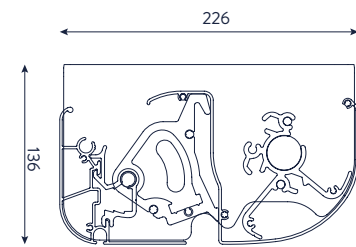
- Semi-closed cassette
- Projection up to 3 m
- Max. width 5,50 m



-  B20:
  - Ceiling fixation
  - Inclination between 5 and 40°
-  B21:
  - Inclination between 20 and 60°
  - More shade and privacy

**Dimensions**  
 Width: min. 2,05 m - max. 5,50 m  
 Projection\*: 1,50 m - 2,00 m - 2,50 m - 3,00 m  
 Operation: Somfy IO or RTS + remote control  
 Cassette: 13,5 cm high x 22,5 cm deep

**Standard colours**

BRUSTOR White    RAL 9001

All other RAL colours optional.

\*Possible projection depends on the width of the awning

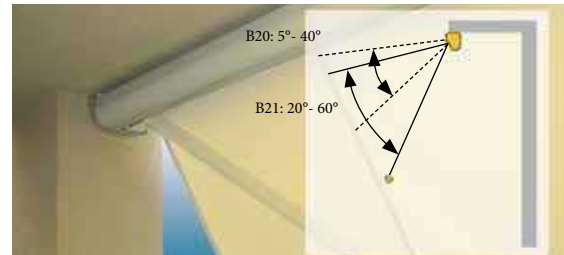

# TWINSTOR

The Brustor Twinstor creates shadow wherever you prefer: with two ground anchors or freestanding galvanised steel flowerboxes, this autonomous awning is anchored in the garden or on the terrace without attachment to an existing wall or porch. The fabric and the mechanical parts are protected in an optimal way thanks to the two fully enclosed cassette casings. The arms are electrically controlled with a remote control.

LED lighting and a patio heater operated by a remote control are convenient when you want to enjoy your Twinstor on cooler evenings.

- Self-supporting structure composed of two B25 awnings, also available with B25 Elite
- The eye-catcher of every terrace
- Autonomous awning
- Electrically controlled
- Fully enclosed cassette
- Shadow surface up to 42 m<sup>2</sup>

**Dimensions**  
 Width: min. 2,05 m - max. 7,00 m  
 Projection: 2 x 2,0 m or 2 x 2,5 m or 2 x 3,0 m  
 Height: standard 2,7 m, in option up to 3,0 m  
 Operation: Motor with remote control

**Standard colours awnings**

BRUSTOR White    RAL 7016 TX    RAL 9001    ANO 20 µm

**Standard colours frame**

RAL 9007 TX

All other RAL colours optional.

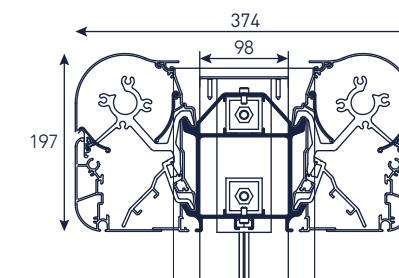

Beside ground anchors, the Twinstor can alternatively be fixed in flowerboxes with reinforcement braces.







# TOPSCREEN

The Topscreen is a windproof and anti-insect screen which covers skylights and other horizontal or inclined glass roof structures, compact porches and greenhouses. The combination of the ZIP screen technology with the tension spring system ensures the fabric stays under perfect tension in any position, even at a wind force of 6 Beaufort. The screen can be equipped with a blackout fabric.

- Compact conservatory awning with ZIP screen technology
- For horizontal or inclined glass structures
- Withstands wind forces up to 6 Bft
- High-quality anti-solar or blackout fabric
- Possible to couple up to 6 m

### Dimensions

Type of fabric: Soltis 86 - Soltis 92 - Blockout Lunar (Blackout)

Fabric height: up to 3 m / coupled up to 6 m

Projection: up to 3 m

Max inclination: 0 - 90°

Operation: motor with switch or with transmitter

Cassette: 11 cm x 11 cm

### Standard colours



All other RAL colours optional.

# B126

The B126 is a motorized awning with lateral guides for conservatories, greenhouses and inclined glass roofs. The lateral guide system offers an extension up to 1m25 over the front of your conservatory. The specially designed cassette casing prevents leaves and dirt from getting rolled up in the fabric. The conservatory awning B126 provides shade up to 5 m wide and 6 m projection with a maximum fabric surface area of 19 m<sup>2</sup>. A coupled version creates shade up to 10 m wide with a maximum fabric surface area of 38 m<sup>2</sup> (acryl fabric) or 36 m<sup>2</sup> (Soltis fabric).

- Motorised conservatory awning
- Optional extension up to 1,25 m
- Up to 19 m<sup>2</sup> shade, coupled up to 38 m<sup>2</sup>

### Dimensions

	B126	B126 coupled
Width:	max 5 m	max 10 m
Projection:	max 6 m	max 6 m
Motor:	1 x	

### Max. fabric surface

Acryl	max 19 m <sup>2</sup>	max 38 m <sup>2</sup>
Soltis 86	max 19 m <sup>2</sup>	max 38 m <sup>2</sup>
Soltis 92	max 18 m <sup>2</sup>	max 36 m <sup>2</sup>

### Standard colours



All other RAL colours optional.



Extendable up to 1,25 m

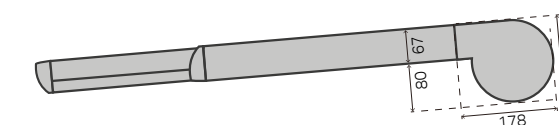





The B127 can be equipped with an extension up to 1,25 m, which provides additional shading into your veranda.



# B127 VERANDA

The B127 Veranda is a flexible conservatory awning system where the guides can be installed up to 1 m in from the edges of the conservatory. Thanks to the unique design of the B127, conservatories with bevelled corners can be completely covered.

The B127 is also available with an extension up to 1,25 m over the front of the conservatory, which provides as an added benefit frontal sun protection. The motorised conservatory awning B127 offers a maximum width of 6 m, projection of 5 m and fabric surface area of 22 m<sup>2</sup>.

- Motorised conservatory awning
- Extension up to 1,25 m
- Flexible awning

### Dimensions

Width: max. 6 m

Projection: max 5 m

Operation: Somfy RTS or IO motor

### Fabric surface

Acryl: 22 m<sup>2</sup>

Soltis 86: 19 m<sup>2</sup>

Soltis 92: 18 m<sup>2</sup>

### Standard colours



All other RAL colours optional.

\* until end of stock



# B128 VERANDA

The B128 veranda, just like the B128 pergola, consists of a tightly stretched canvas based on ZIP-screen technology. The canvas with the B128 veranda is only sun-shading. The supports are directly fastened to the veranda roof. The guides are then fixed to the supports.

- Extremely wind resistant conservatory awning
- Regulate the perfect amount of light and shading

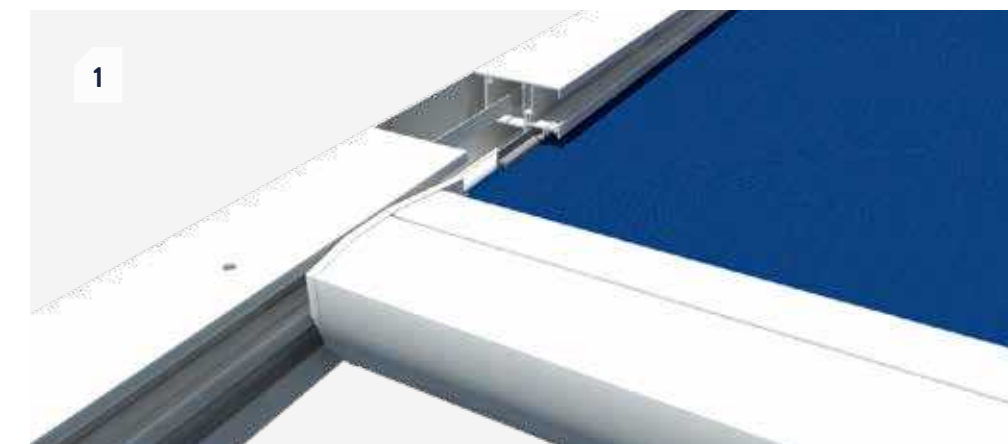

Thanks to the ZIP-screen technology the fabric is kept secure in the guide.

### Dimensions

Width: max. 6 m

Projection: max. 5 m

Operation: Somfy RTS or IO motor

### Standard colours



All other RAL colours optional.

Selection of fabrics to choose from: Soltis 86/92 and acryl fabrics.





Minimalism  
is its asset!

## B128 coupled

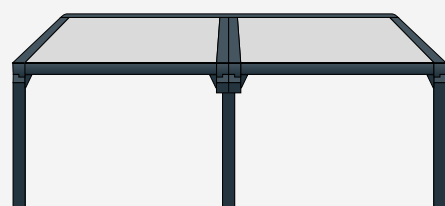

### Max dimensions

- Single pole in the middle but always two beams.
- Water drainage from both roofs is possible through the couple pole.
- No LED strip possible in the couple pole.

## B128 Screens

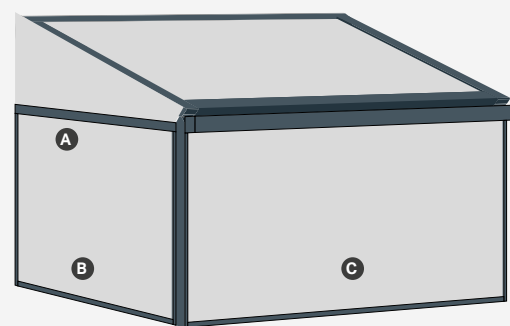

- A** For more privacy, you can close the sides of the B128 entirely with a fixed side canvas
- B** ZIP-screen with maximum projection of 4m.
- C** B1100/B1350 Solar as screen at the frontside.



Optional adjustable foot

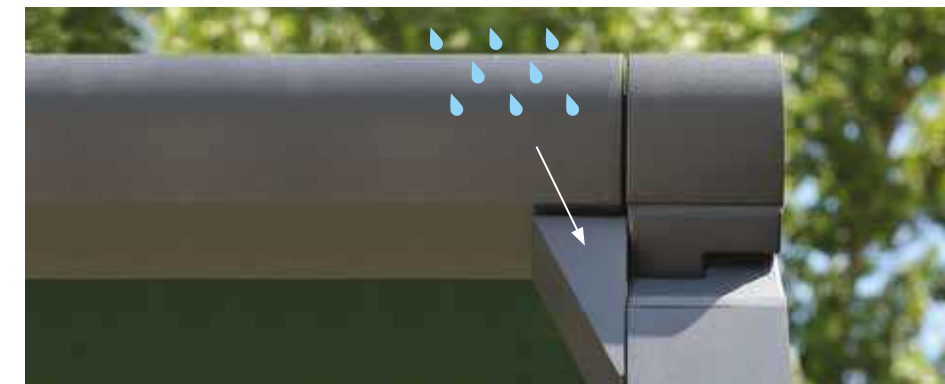

Water drainage through supporting posts



LED lighting options possible in the side guides, the supporting posts or under the support beam



Valance of 1m (Soltis 86/92). The motor runs on a battery which is charged by a small solar panel.

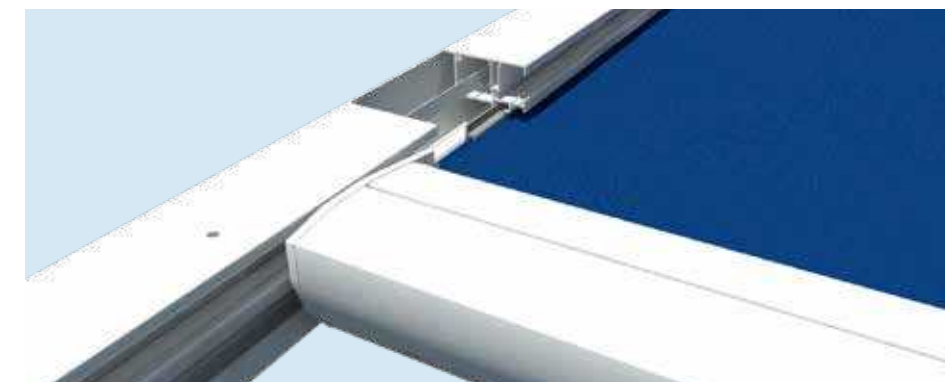

The fabric roof is held tightly into the guides thanks to the continuous tension of the ZIP screen technology

# B128

 Remote control included

The B128 pergola is a minimalistic aluminum terrace cover with a sun and rain resistant roof that uses ZIP-screen technology. The system keeps the canvas tightly stretched with efficient tension mechanisms in the side guides for wind resistance, so without sides flapping up. This smooth surface and the minimal slope of 15cm/m ensures that every drop of rain quickly flows into the invisibly integrated gutter in the front profile.

When closed it offers all the advantages of a real roof, when fully open the B128 pergola disappears and is as good as invisible. The B128 has also a lot of LED lighting options. You can even change the height of the roof thanks to an optional manually operated supporting pole.

- Light yet robust frame
- Regulate the perfect amount of light, sun shading and ventilation

### Options



- LED lighting in the side guides, the supporting posts or under the support beam
- Possibility to manually adjust the height on one side
- Water-repellent wall connection
- Wind- / sunsensor



B128

- Aluminum terrace cover with a rain resistant fabric
- Canvas based on ZIP-screen technology
- Overhang possible at 1/3 from the extension to max 1 m
- Poles and guides both 8 x 8 cm
- Motorised valance of 1m with RTS motor works on solar panel + battery.

### Max dimensions

-  6 m x 5 m
-  5 m x 5 m (with valance)

### Standard colours



Wide selection of watertight fabrics.





Create a comfortable indoor climate whilst maintaining the view

# ZIPSCREEN

The B1085, B1100 and B1350 ZIP are wind resistant screens and at the same time act as an insect repellent. The unique zip system keeps the fabric locked in the side guides at every position. The ZIP screen passes the highest wind speed classification and is available with a round or square cassette, depending on the height of the screen. The maximum surface area can be 18m<sup>2</sup>. The ZIP screen is also available in a coupled version.

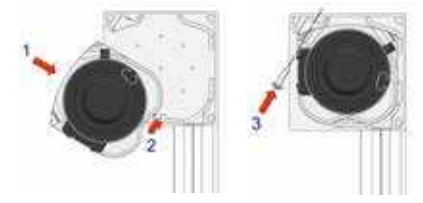

For all standard and ZIP screens, the rolltube can be removed very easily from the cassette without having to disassemble the screen.

- Wind resistant screen
- Insect repellent screen
- Resistant to high wind speeds
- Round or square housing

Round Cassette



Square Cassette



Locking system for a better tension of the fabric.

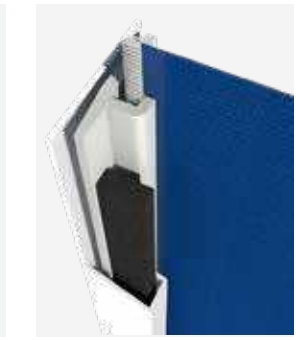

Optional motor on solar-energy. see page 30



Dimensions	B1085 SR/C ZIP	B1100 SR/C ZIP	B1350 C ZIP
Type of fabric:	Screen fabric (Sergé 600) - Soltis 86 - Soltis 92 - Blockout Lunar (Blackout)		
Height:	max 1,8 m	max 3,5 m	max 6,0 m
Width:	0,8 - 3,6 m	0,8 - 4,0 m	0,8 - 6,0 m
Width when coupled:	1,6 m - 7,2 m		not possible
Surface:	6,5 m <sup>2</sup> - 13 m <sup>2</sup>	14 m <sup>2</sup> - 25,2 m <sup>2</sup>	max 18 m <sup>2</sup>
Cassette:	8,5 cm x 8,5 cm	11 cm x 11 cm	13,5 cm x 13,5 cm
Operation:	Somfy motor with switch (or manual*)		Somfy motor with switch
Guide:	Clips or screwed rail		

\* With limited dimensions the motor can be replaced by a gear

### Standard colours

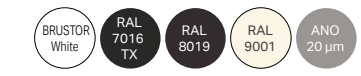

All other RAL colours optional.





# B1100 & B1350 ZIP SOLAR

Discover our solar-powered screens, a sustainable solution where we use a natural energy source to make the screen work. Also ideal for spaces where no power supply is possible. The motor of the screen is powered by a battery which in turn is charged by sunlight. A solar panel provides the battery with the required energy.

The energy stored in the battery guarantees the continuous functioning of the B1100 / B1350 ZIP Solar in sunny and slightly cloudy weather.

## Dimensions

Type of fabric: Soltis 86 - Soltis 92 - Blockout Lunar (Blackout)

Height: up to 3 m

Width: up to 5 m (B1350)

Operation: Somfy motor with remote (IO of RTS)

## Standard colours

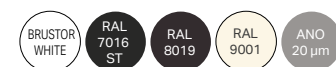

All other RAL colours optional.



# B1200 ZIP

The B 1200 is fully integrated into the wall cavity and forms a seamless transition between the wall and the window. No disturbing elements that restrict visibility. According to the Brustor ZIP screen technology the screen slides fully automatically and tightly through the side guides. The heavy front profile keeps the cloth tight in the side guides. The ZIP screens are the guarantee for wind resistant, sun filtering and insect-repellent window screens. The B1200 can be delivered in a whole range of screen fabrics. Replacing the fabric roller tube happens in a very simple way.

- Screen cassette and side guides can be integrated
- The lead rail disappears into the cassette
- Screen to be mounted together with the windows
- Easy access to the roller tube and fabric

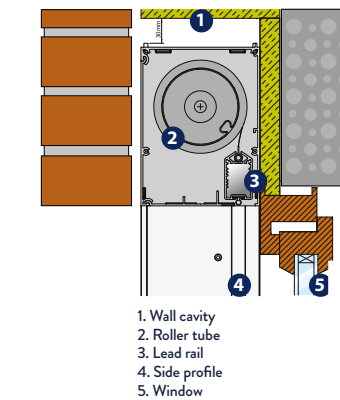

## Dimensions

Type of fabric: Soltis 86 - Soltis 92 - Blockout Lunar (Blackout) - Screen Sergé 600

Maximum height: up to 3,5 m

Maximum width: up to 5 m (coupled up to 7,2 m)

Operation: Somfy motor with switch (RTS or IO)

## Standard colours



All other RAL colours optional.



# CORNER SCREEN

Our Brustor Corner screen is based on the strong, wind resistant technology of the B1350 C built-on screen with square cassette. It is a fully automatic, panoramic screen that slides up and down in a straight angle evenly in the outer side guides. There are no disturbing profiles in the screen itself. An ideal solution for situations where the stained-glass windows without support profile meet in the corner. This will provide a wide unobstructed view, while the shade will be obtained evenly in the living area.

You can command the screen by an electric motor LT, RTS or IO. With the latter one you can easily control the screen with your smartphone. The motor is always located on the longest side.

- Perfect for angular constructions where the stained glass windows are connected to each other without corner profile

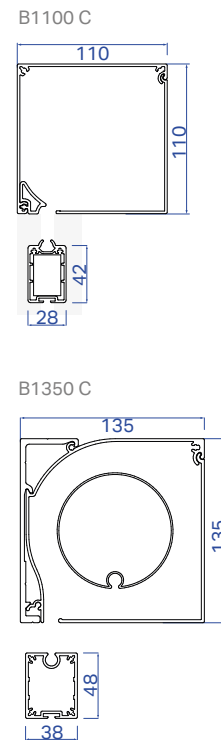

Dimensions	B1100 C ZIP	B1350 C ZIP
Maximum height	up to 3 m	up to 3 m
Maximum width	up to 4 m (6m both screens)	up to 4 m (7m both screens)
Operation	Somfy motor with switch (RTS or IO)	

**Standard colours**

BRUSTOR White, RAL 7016 TX, RAL 9019, RAL 9001, ANO 20 µm

All other RAL colours optional.



# STANDARD SCREEN

The vertical screens B1085 and the B1100 are in a compact and elegant casing, depending on the height of the window. The maximum width is 4 m and 7,20 m when coupled. The maximum height of the screen is 4 m. The small, discrete cassette makes sure that the Brustor screens matches perfectly on every facade. The screens can be produced in any RAL colour. In addition to the default screen. A built-in version is also available.

- Vertical screens
- Maximum privacy
- With integrated motor
- Max. width 4 m / Coupled max. 7,2m



Dimensions	B1085 SR/C	B1100 SR/C
Type of fabric:	screen fabric (Sergé 600), Soltis 86 - Soltis 92 - Blockout Lunar (blackout)	
Height fabric	max 3,5 m	max 4,0 m
Width	0,8 - 3,6 m	0,8 - 4,0 m
Width coupled:	1,61 m - 7,2 m	
Surface:	8 m <sup>2</sup> - 16 m <sup>2</sup>	
Cassette dimensions:	8,5 cm x 8,5 cm	11 cm x 11 cm
Operation:	IO or RTS motor (or gear*)	

### Standard colours



All other RAL colours optional.

\*With limited dimensions the motor can be replaced by a gear.

# INDOOR SCREEN



If a screen cannot be mounted outside, an Indoor Screen can provide a maximum possible protection against solar heat and harsh light levels. Even equipped with a motor, they will remain discrete and stylish. They are also available with remote control or gear.

- Elegant and functional
- Indoors

Dimensions	
Type of fabric:	screen fabric (Sergé 600), Soltis 86 - Soltis 92 - Blockout Lunar (Blackout)
Height fabric:	max. 6 m
Width:	0,8 m - 6 m (not possible to couple)
Max surface:	18 m <sup>2</sup>
Operation:	motor / manual*

**Standard Colours**

BRUSTOR WHITE, RAL 7016 ST, RAL 9019, RAL 9001, ANO 20 µm

All other RAL colours optional.

\*With limited dimensions the motor can be replaced by a gear.





## B2100 DROP ARM AWNING

The Brustor B2100 is a drop arm awning with wind resistant side arms. The fabric is covered in an extruded aluminum, powdercoated, full cassette casing. Thanks to the heavy duty springs in the arms, the fabric stays taut at every position. The B2100 awning can drop up to 90° or 135°. The maximum width is 5 m for a single unit and 6 m for a coupled one. The standard motor can be replaced by an optional gear.

- Wind resistant drop arm awning
- Inclination up to 90° or 135°
- Max. width 5 m, coupled up to 6 m

### Dimensions

Type of fabric: Screen, Soltis, Acrylic fabric

Width fabric: 0,65 m - 5 m (coupled up to 6 m)

Projection: 0,80 m - 1 m - 1,20 m - 1,40 m (depending on width and fabric)

Max inclination: up to 90° or 135°

Operation: motor (gear optional)

Cassette: 12,8 cm x 13,2 cm

### Standard colours



All other RAL colours optional.

## WINDBLOCKER

This horizontal tensioned blind is the ideal solution for a windy terrace and to provide maximum privacy in exposed locations. The Windblocker can also be used to provide angled shade. The height of the handle on the manually operated Brustor Windblocker can be placed at any position on the lead rail. The tensioned fabric can be fixed against the wall or to a pole. A high quality heavy duty spring ensures the fabric remains taut. The stylish cassette casing is made from extruded powdercoated aluminum.

- Windshield for your terrace
- Provides extra privacy
- Manual operation
- Fixed against the wall or to a pole

### Dimensions

Height: acryl fabric: from 1,275 m up to 2,00 m  
Soltis 86 fabric: from 1,275 m up to 1,86 m

Projection: 2,00 m - 3,00 m - 4,00 m

### Standard colours



All other RAL colours optional.



1 A locking system ensures the screen staying taut, even with variable wind speed.



2 Stable attachment in supporting pole.



3 Increased ease of use thanks to the built-in support wheel.



4 Option: bonings for a better strengthening, only possible with a Soltis fabric.

The new pole encloses the lead rail and provides more stability.



The new foot ensures that the lead rail remains in place and cannot role backwards in case of strong wind.







# BRUSTOR

### THE SUCCESS OF A FAMILY BUSINESS

Brustor is a family business that has been manufacturing outdoor living pods, awnings and screens for decades. Innovation, quality and a high level are still the key to our success. Together with our many years' experience, we are able to respond to every demand.

### LEADING COMPANY IN EUROPE

Through the years Brustor, a family business, has become a strong player in the international market of sun protection. The in-house production occurs in our new, 50.000m<sup>2</sup> production hall in Gullegem (BE), from where our products are transported worldwide to 30 countries. Even our warehouse continues to grow, so we are able to supply the orders very quickly.

### OUR PEOPLE MAKE THE DIFFERENCE

Our most important capital are our employees. Highly skilled people who always go the extra mile. Whether they are operating machines with greatest precision, accomplishing a commercial role, implementing installations or studying innovating techniques; each and every one of them is an experienced, motivated, customer oriented person with a passion for quality.

### STATE-OF-THE-ART MACHINES

Top quality products demand well-oiled machinery capable of handling the most advanced production and assembly techniques. Operated by highly trained people, our state-of-the-art machines are the acme of precision. High productivity guaranteed. Thanks to a modern powdercoating system, each colour can be realised on our own site.

**CE CERTIFICATE**  
All Brustor products approve to the European quality and safety standards..

## OPTIONS AND TECHNICAL INFO

	FULLY ENCLOSED CASSETTE	2 CABLES ARM 66MM 5 BEAUFORT	4 CABLES ARM 71MM 5 BEAUFORT	4 CABLES ARM 73MM 6 BEAUFORT	MAXIMUM WIDTH	MAXIMUM PROJECTION	MOTOR WITH SWITCH	MOTOR WITH REMOTE CONTROL	MOTOR WITH EMERGENCY OVERRIDE	LED STRIP COMPLETE ARM	INTEGRATED LED SPOT IN ELBOW	LED STRIP UNDER THE CASSETTE	BRUSTOR WHITE	RAL 8019 BROWN	RAL 9001 CREAM	RAL 7016 ANTHRACITE GREY (TEXT.)	ANODIZED 20µm	VALANCE	MOTORISED VALANCE
B24 Elite	☑	☑			14	3,75	☑	option	option	option		option	☑	☑	☑	☑	☑	option	
B24 Prestige	☑			☑	14	3,75		☑	option		option	option		ALL RAL COLOURS FREE				option	
B25	☑	☑			14	3	☑	option	option			option	☑	☑	☑	☑	☑	option	
B25 Elite	☑	☑			14	3,75	☑	option	option	option		option	☑	☑	☑	☑	☑	option	
B25 Prestige	☑			☑	14	3,75		☑	option		option	option		ALL RAL COLOURS FREE				option	option
B27	☑	☑			14	3	☑	option	option			option	☑	☑	☑	☑	☑	option	
B27 Elite	☑		☑		14	3,75	☑	option	option	option		option	☑	☑	☑	☑	☑	option	
B27 Prestige	☑			☑	14	3,75		☑	option		option	option		ALL RAL COLOURS FREE				option	
B35	option				15	4	☑	option	option	option		option	☑	☑	☑	☑	☑	option	
B35 Prestige	option			☑	15	4		☑	option		option	option	☑	☑	☑	☑	☑	option	
B38	option				6	3,5	☑	option	option	option		option	☑	☑	☑	☑	☑		☑
B38 Prestige	option			☑	6	3,5		☑	option		option	option	☑	☑	☑	☑	☑		☑
B50	☑	☑			5,5	3	☑	option					☑	☑	☑	☑	☑	option	
B50 XL	☑		☑		6	3,5	☑	option		option		option	☑	☑	☑	☑	☑	option	
B34			☑		6	3	☑	option				option	☑	option	option	option		option	
B40	option				7	3,5	☑	option					option	option	option	option	☑		
B20			☑		5,5	3	☑	option					☑	option	☑	option		option	
B21			☑		5,5	3	☑	option					☑	option	☑	option		option	

### 5 YEARS BRUSTOR-GUARANTEE

All Brustor products are thoroughly tested to the highest quality standards. Our installers are highly qualified professionals who undergo continuous product training. They are responsible for a perfect installation and excellent after sales service. Thanks to this approach all Brustor products are guaranteed for a period of 5 years. On request the terms of the guarantee can be obtained from your local dealer. More info about the guarantee on all parts, see page 6.

**5 years** on the cassette and parts.  
**10 years** on the moving parts of the awning.  
**2 years** on LED lighting and heaters.



Your Brustor dealer



Outdoor Living



Awnings



Conservatory awnings



Screens

**BRUSTOR**<sup>®</sup>  
OUTDOOR SUN SYSTEMS  
[www.brustor.com](http://www.brustor.com)



Outdoor Living



Awnings

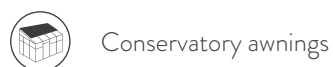

Conservatory awnings



Screens