

**NKBC**<sup>®</sup>  
INC

NATIONAL KITCHEN & BATH  
C A B I N E T R Y

**CATALOG**

MANUFACTURER WHOLESALE SHOWROOM



# TABLE OF CONTENTS

<b>Introduction</b>	<b>3</b>
<b>Product &amp; Construction</b>	<b>4</b>
<b>Door Styles</b>	<b>5</b>
<b>Classic White</b>	<b>6</b>
<b>Dark Chocolate</b>	<b>8</b>
<b>French Vanilla</b>	<b>10</b>
<b>Shaker White</b>	<b>12</b>
<b>Chestnut Brown</b>	<b>14</b>
<b>Pearl Gray</b>	<b>16</b>
<b>Specialty Cabinets</b>	<b>18</b>
<b>Molding &amp; Decor</b>	<b>20</b>
<b>Organization &amp; Storage</b>	<b>21</b>
<b>Product Specifications</b>	<b>22</b>
<b>Base Cabinets</b>	<b>24</b>
<b>Wall Cabinets</b>	<b>26</b>
<b>Tall Cabinets</b>	<b>30</b>
<b>Vanity Cabinets</b>	<b>31</b>
<b>Molding &amp; Decor</b>	<b>32</b>
<b>Accessories</b>	<b>38</b>
<b>Kitchen Standard Size &amp; Item Code</b>	<b>40</b>
<b>Vanity Concept</b>	<b>42</b>
<b>Special Order Sinks</b>	<b>44</b>
<b>Warranty</b>	<b>45</b>
<b>Exclusive Door Style</b>	<b>46</b>

## ***About Us***

National Kitchen & Bath Cabinetry, also known as NKBC, is a wholesale cabinet supplier offering Semi-Custom All Wood Cabinets. NKBC was established in Concord, NC in 2016. In less than three years, we have grown to be one of the leading players in the cabinet industry throughout the United States. When NKBC's first location opened, we started with only three product lines. We have since expanded our products and have been able to provide quality cabinets for the needs of every customer at affordable prices. Our design team works actively with our factory to meet the needs and expectations of our customers. Our innovative designs and quality craftsmanship set us above the competition. Our goal is to make your home more stylish and comfortable while providing exceptional value with endless possibilities. NKBC is proud to announce that we have trademarked our products to two of the largest authorized cabinet wholesale distributors in Austin, TX and Romeoville, IL.

## ***Our Mission and Goal***

NKBC insists on the principle of maintaining customer satisfaction by delivering great products, prices, and services. **No job is too small!**

## ***About Price***

NKBC, a wholesale cabinet supplier aims to provide high quality cabinets. As a wholesaler, we purchase in large volumes at a lower cost while offering exceptional value. We are then able to pass those savings to our customers by keeping our prices economical and affordable.

## ***About Clients***

Our target clientele is anyone related to the cabinet and construction industry (distributors, developers, builders, retailers, contractors, designers, etc.). The NKBC showroom is open to the public, however, we do not sell to the end users or homeowners. If you are a homeowner and you are interested in our products, you can bring your own contractor or we can help you to contact the nearest NKBC authorized dealer in your area.

## ***About Services***

We believe a product is only as good as the service that supports it. With our large inventory and variety of cabinet styles and sizes, customer orders can be fulfilled within days. We offer delivery for an additional charge for local customers. For out of state or international customers, we offer shipping via popular freight logistic companies. To meet our customer's specific needs, we also offer assembly, semi-custom services and modification applications for our cabinets.





# PRODUCT & CONSTRUCTION

## About Products

All of NKBC's cabinets are Ready-To-Assemble (RTA) and Semi-Customizable to our customer's specific needs. Our cabinets are all-wood, plywood construction (Absolutely no particle board or MDF), dovetail drawer boxes, and a full overlay door style. They also come standard with under-mounted, full extension, heavy duty, soft-close drawer glides and 6-way adjustable, European Style, hidden, soft-close hinges. Not only do we offer constructed, standard sizes available in 3-inch increments, but we also offer an extensive selection of accessories such as moldings, corbels, posts, valances, and decorative doors. With variety of product styles, finishes, and features, NKBC is able to provide every customer with endless possibilities.



- 1 3/4" Full Overlay Door, Solid Wood Center Panel
- 2 Soft Close, 6 Way Adjustable European Style Hidden Metal Hinges
- 3 3/4" Full Depth, Edge Banded, Adjustable Plywood Shelf, Shelf Holder with Plastic Sucker & Thread for Wood/Glass Shelf
- 4 Dovetail Drawer, 1/2" Solid Wood Sides
- 5 Undermount Full Extension Soft Close Drawer Glides
- 6 5/8" Plywood Side Panel with Clear Coat / Natural Wood Interior Finish & Matching Finish Exterior
- 7 Metal Bracket Reinforcements for Base Cabinets
- 8 Adhesive Clear Door Bumper



# DOOR STYLES

### Classic White



### Dark Chocolate



### French Vanilla



### Shaker White



### Chestnut Brown



### Pearl Gray



Note: Not all door styles and finishes are available at certain locations. Please check with your NKBC showroom for current availability. Due to printing limitations, catalog pictures may not be true to the color. We strongly recommend you view an actual product sample for best color and wood grain representation.









Farmhouse Sink



**CLASSIC  
WHITE**









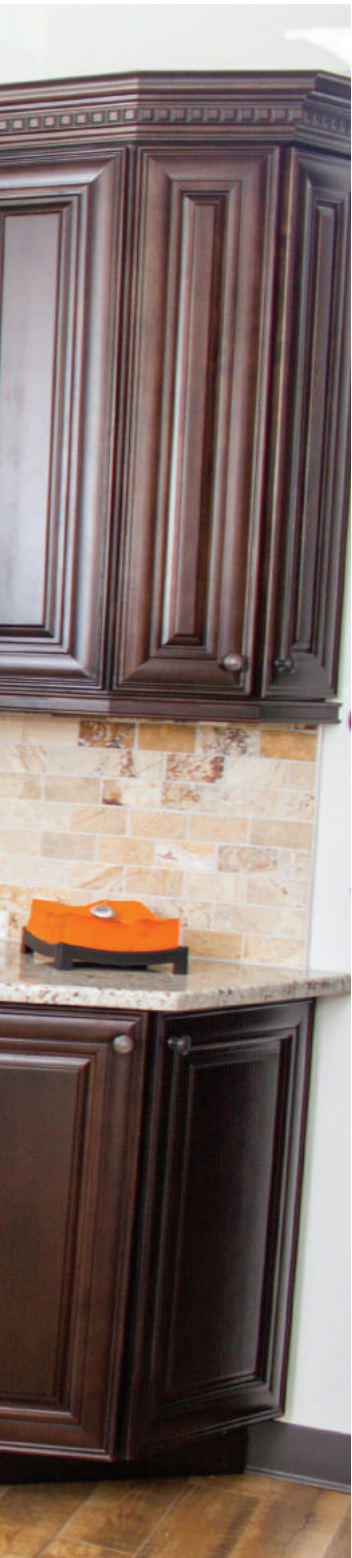

**DC** DARK CHOCOLATE



INNOVATION + INSPIRATION









Frosted Glass Insert



FV

# FRENCH VANILLA





Clear Glass Insert







Under Counter Microwave



**SW** SHAKER  
WHITE









CB

CHESTNUT BROWN











PG

PEARL  
GRAY





# SPECIALTY CABINETS







Wall End Corner



Knee Drawer



Lift Up Design



Base Diagonal Corner



Base End Corner



Wall Microwave Cabinet



Base Lazy Susan



Spice Drawer



Bench Design



# MOLDING & DECOR



Small Leaf Corbel

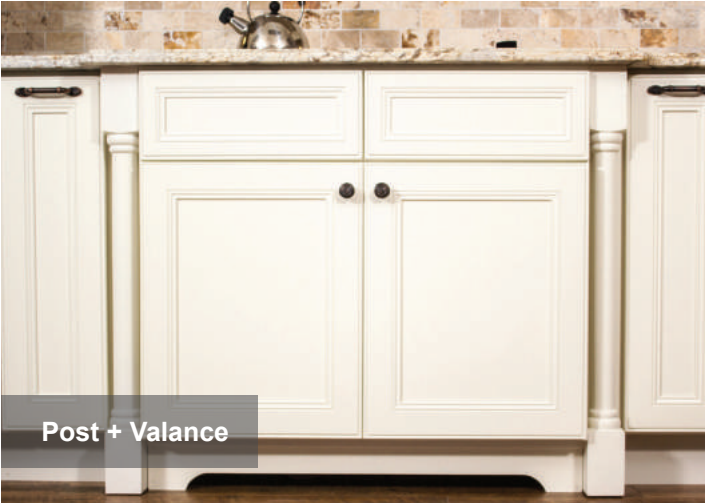

Post + Valance



Classic Crown Molding



Dentil Crown Molding



Shaker Cove Molding



Light Rail Molding



Base Molding



# ORGANIZATION & STORAGE *(Special Order)*





# UNDERSTANDING OUR PRODUCT SPECIFICATIONS

The cabinet specifications combine product information, illustrations, and features all in one easy-to-use reference manual.

## WALL CABINET

ITEM NAME

W1836

WIDTH

HEIGHT

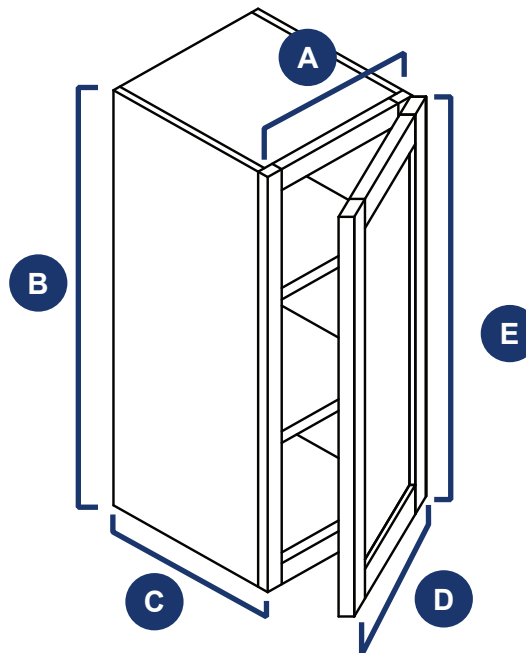

### CABINET DIMENSIONS

- A** Width 18"
- B** Height 36"
- C** Depth 12"

*THIS DIMENSION IS NOT LISTED IN THE ITEM CODE BECAUSE IT IS THE STANDARD WALL CABINET DEPTH*

### CABINET DOOR DIMENSIONS

- D** Width 17 3/4"
- E** Height 35 1/2"

## WALL REFRIGERATOR CABINET

ITEM NAME

W361827

WIDTH

HEIGHT

DEPTH

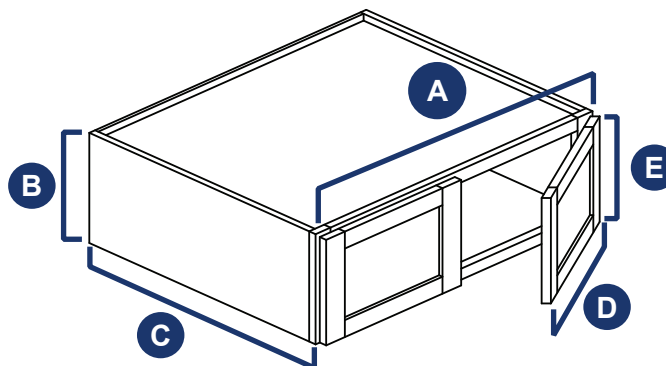

### CABINET DIMENSIONS

- A** Width 36"
- B** Height 18"
- C** Depth 27"

### CABINET DOOR DIMENSIONS

- D** Width 17 3/4"
- E** Height 17 1/2"



## KITCHEN BASE CABINET

ITEM NAME

B 18

WIDTH

## VANITY BASE CABINET

ITEM NAME

VB18

WIDTH

● KITCHEN

● VANITY

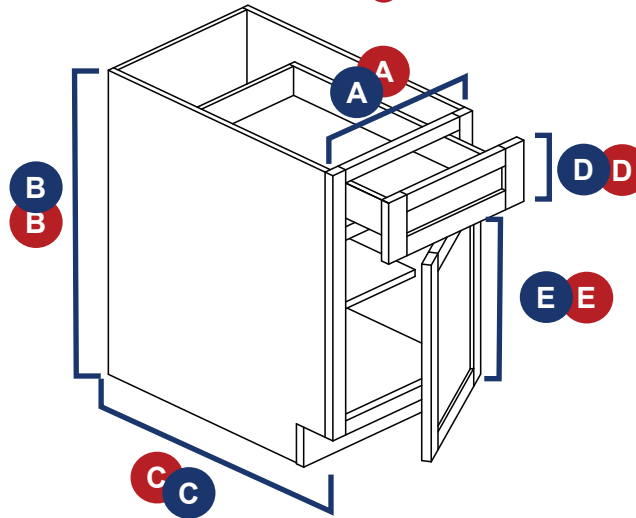

### BASE DIMENSIONS

- A A** Width 18"
- B B** Height 34.5"  
*THIS DIMENSION IS NOT LISTED IN THE ITEM CODE BECAUSE IT IS THE STANDARD BASE CABINET HEIGHT*
- C** Depth 24"  
*THIS DIMENSION IS NOT LISTED IN THE ITEM CODE BECAUSE IT IS THE STANDARD KITCHEN BASE CABINET DEPTH*
- C** Depth 21"  
*THIS DIMENSION IS NOT LISTED IN THE ITEM CODE BECAUSE IT IS THE STANDARD VANITY BASE CABINET DEPTH*

### DRAWER DIMENSIONS

- D D** Height 7"

### DOOR DIMENSIONS

- E E** Height 22"

## KITCHEN DRAWER BASE CABINET

ITEM NAME

DB18-3

WIDTH

NUMBER OF DRAWERS

● KITCHEN

● VANITY

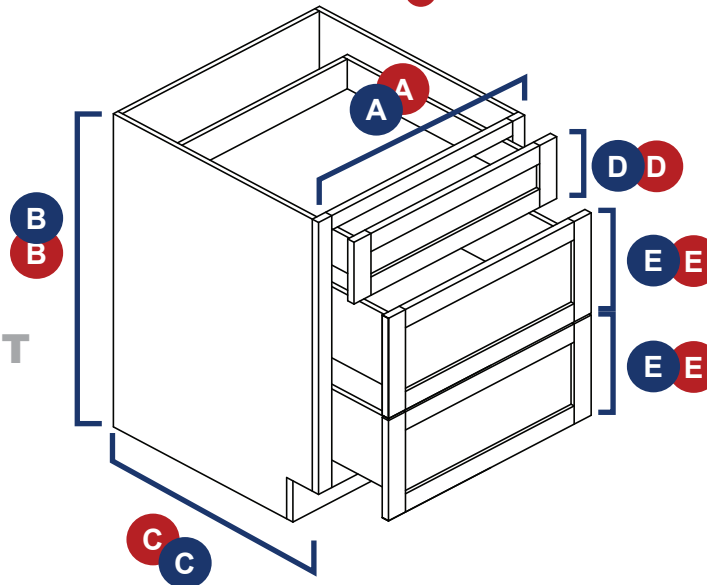

### DRAWER BASE DIMENSIONS

- A A** Width 18"
- B B** Height 34.5"  
*THIS DIMENSION IS NOT LISTED IN THE ITEM CODE BECAUSE IT IS THE STANDARD DRAWER BASE CABINET HEIGHT*
- C** Depth 24"  
*THIS DIMENSION IS NOT LISTED IN THE ITEM CODE BECAUSE IT IS THE STANDARD KITCHEN DRAWER BASE CABINET DEPTH*
- C** Depth 21"  
*THIS DIMENSION IS NOT LISTED IN THE ITEM CODE BECAUSE IT IS THE STANDARD VANITY DRAWER BASE CABINET DEPTH*

## VANITY DRAWER BASE CABINET

ITEM NAME

VBD18-3

WIDTH

NUMBER OF DRAWERS

### DRAWER DIMENSIONS

- D D** Height 7"
- E E** Height 10 7/8"



# BASE CABINETS

	ITEM CODE	W"x H"x D"	WT/LB	AVAILABLE STYLES
--	-----------	------------	-------	------------------

## BASE CABINET - 1 DRAWER, 1 DOOR

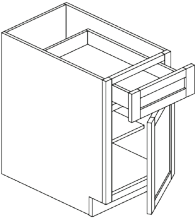
	B09	09 x 34.5 x 24	40.0	DC CW CB FV PG SW
	B12	12 x 34.5 x 24	45.0	DC CW CB FV PG SW
	B15	15 x 34.5 x 24	49.0	DC CW CB FV PG SW
	B18	18 x 34.5 x 24	54.0	DC CW CB FV PG SW
	B21	21 x 34.5 x 24	57.0	DC CW CB FV PG SW
1 Drawer, 1 Door, 1 Adj. Shelf, 1 Set Glide				

## BASE CABINET - 1 DRAWER, 2 DOORS

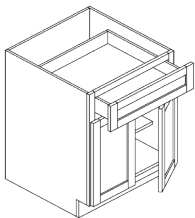
	B24	24 x 34.5 x 24	61.0	DC CW CB FV PG SW
	B27	27 x 34.5 x 24	65.0	DC CW CB FV PG SW
	B30	30 x 34.5 x 24	68.0	DC CW CB FV PG SW
1 Drawer, 2 Doors, 1 Adj. Shelf, 1 Set Glide				

## BASE CABINET - 2 DRAWERS, 2 DOORS

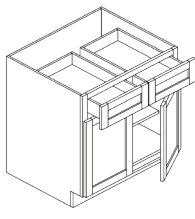
	B33	33 x 34.5 x 24	87.0	DC CW CB FV PG SW
	B36	36 x 34.5 x 24	89.0	DC CW CB FV PG SW
	B42	42 x 34.5 x 24	92.0	DC CW CB FV PG SW
2 Drawers, 2 Doors, 1 Adj. Shelf, 2 Sets Glides				

## SINK BASE CABINET

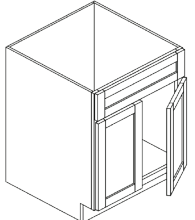
	SB30	30 x 34.5 x 24	50.0	DC CW CB FV PG SW
	1 Dummy Drawer, 2 Doors, No Shelf <b>Note: Back Panel Not Cut for Plumbing</b>			

## SINK BASE CABINET

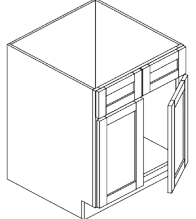
	SB33	33 x 34.5 x 24	56.0	DC CW CB FV PG SW
	SB36	36 x 34.5 x 24	58.0	DC CW CB FV PG SW
	SB42	42 x 34.5 x 24	61.0	DC CW CB FV PG SW
2 Dummy Drawers, 2 Doors, No Shelf <b>Note: Back Panel Not Cut for Plumbing</b>				

## BASE DRAWER CABINET - 3 DRAWERS

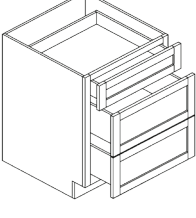
	DB12-3	12 x 34.5 x 24	66.0	DC CW CB FV PG SW
	DB15-3	15 x 34.5 x 24	72.0	DC CW CB FV PG SW
	DB18-3	18 x 34.5 x 24	77.0	DC CW CB FV PG SW
	DB21-3	21 x 34.5 x 24	84.0	DC CW CB FV PG SW
	DB24-3	24 x 34.5 x 24	90.0	DC CW CB FV PG SW
	DB27-3	27 x 34.5 x 24	98.0	DC CW CB FV PG SW
	DB30-3	30 x 34.5 x 24	104.0	DC CW CB FV PG SW
	DB33-3	33 x 34.5 x 24	108.0	DC CW CB FV PG SW
DB36-3	36 x 34.5 x 24	116.0	DC CW CB FV PG SW	
1 Small Drawer, 2 Large Drawers, 3 Sets Glides				

## BASE BLIND CORNER CABINET (L/R) - SPECIFY L / R

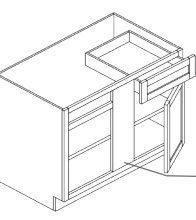
	BBC39 (L/R)	39 x 34.5 x 24	68.0	DC CW CB FV PG SW
	BBC42 (L/R)	42 x 34.5 x 24	76.0	DC CW CB FV PG SW
1 Drawer, 1 Door, 1 Adj. Shelf, 1 Set Glide BBC39: 12" Filler, BBC42: 9" Filler <b>Note: Min. 3" Pull Off the Wall When Install, Specify Left / Right When Ordering Assembled</b>				

Note: Specifications are subject to change without notice. Our style and product availability may vary slightly from those shown in this catalog.



# BASE CABINETS

	ITEM CODE	W"x H"x D"	WT/LB	AVAILABLE STYLES
--	-----------	------------	-------	------------------

## BASE LAZY SUSAN CORNER CABINET

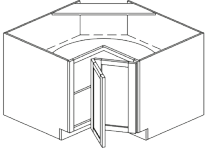
	BLS33	33 x 34.5 x 24	78.0	DC CW CB FV PG SW
	BLS36	36 x 34.5 x 24	84.0	DC CW CB FV PG SW
<p>BLS33 Door Dimensions: 7 1/2" W x 29 1/4" H                  BLS36 Door Dimensions: 10 1/2" W x 29 1/4" H</p> <p>2 Doors, 2 Wooden Kidney Shaped Trays, Non-Soft Close</p>				

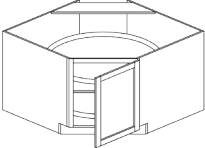

## BASE DIAGONAL CORNER CABINET

	BDC36	36 x 34.5 x 24	87.0	DC CW CB FV PG SW
	<p>Door Dimensions: 14 3/4" W x 29 1/4" H</p> <p>1 Door, 2 Wooden Round Trays</p>			

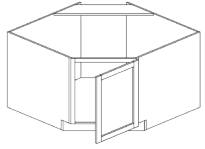
## SINK BASE DIAGONAL CORNER CABINET

	NCSB36	36 x 34.5 x 24	57.0	DC CW CB FV PG SW
	<p>Door Dimensions: 14 3/4" W x 29 1/4" H</p> <p>1 Door, No Self, No Tray</p> <p><b>Note: Back Panel Not Cut for Plumbing</b></p>			

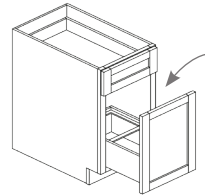
## BASE WASTE BASKET CABINET

	BWBK18-2	18 x 34.5 x 24	65.0	DC CW CB FV PG SW
	<p><b>SOLD SEPARATELY</b></p>  <p>Item Code: 206-Trash Can Plastic Bin Available</p> <p>1 Drawer, 1 Door, 2 Bins Cut Out, 2 Sets Glides</p>			

	ITEM CODE	W"x H"x D"	WT/LB	AVAILABLE STYLES
--	-----------	------------	-------	------------------

## BASE SPICE DRAWER CABINET

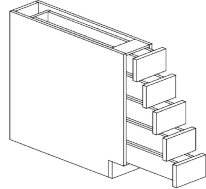
	BSD06	06 x 34.5 x 24	40.0	DC CW CB FV PG SW
	<p>5 Drawers, No Glides, Non-Softclose</p>			

## BASE SPICE PULL OUT

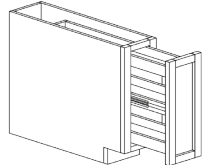
	BSR09	09 x 34.5 x 24	43.0	DC CW CB FV PG SW
	<p>Door Dimensions: 8 3/4" W x 29 1/4" H</p> <p>1 Door, 3 Shelves, 1 Set Glide, Soft-Close</p>			

## BASE END CORNER CABINET

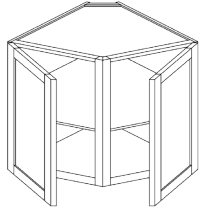
	BEC24	24 x 34.5 x 24	39.0	DC CW CB FV PG SW
	<p>Door Dimensions: 17 3/4" W x 29 1/2" H</p> <p>2 Doors, 1 Adj, Shelf</p>			

## BASE END OPEN SHELF (L/R)

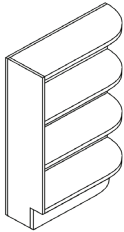
	BES09 L/R	09 x 34.5 x 24	33.0	DC CW CB FV PG SW
	<p>3 Fixed Shelves, Matching Color Finish</p> <p><b>Note: Specify Left/Right When Ordering Assembled</b></p>			

PRODUCT SPECS

Note: Specifications are subject to change without notice. Our style and product availability may vary slightly from those shown in this catalog.



# WALL CABINETS

PRODUCT SPECS

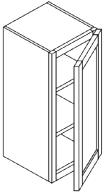
	ITEM CODE	W"x H"x D"	WT/LB	AVAILABLE STYLES
	W0930	09 x 30 x 12	20.0	DC CW CB FV PG SW
	W1230	12 x 30 x 12	23.0	DC CW CB FV PG SW
	W1530	15 x 30 x 12	26.0	DC CW CB FV PG SW
	W1830	18 x 30 x 12	29.0	DC CW CB FV PG SW
	W2130	21 x 30 x 12	33.0	DC CW CB FV PG SW
1 Door, 2 Adj. Shelves				

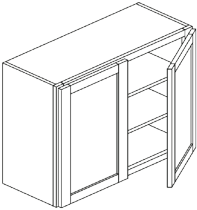
	ITEM CODE	W"x H"x D"	WT/LB	AVAILABLE STYLES
	W2430	24 x 30 x 12	37.0	DC CW CB FV PG SW
	W2730	27 x 30 x 12	40.0	DC CW CB FV PG SW
	W3030	30 x 30 x 12	44.0	DC CW CB FV PG SW
	W3330	33 x 30 x 12	48.0	DC CW CB FV PG SW
	W3630	36 x 30 x 12	50.0	DC CW CB FV PG SW
	W4230	42 x 30 x 12	56.0	DC CW CB FV PG SW
2 Doors, 2 Adj. Shelves				

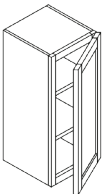
	ITEM CODE	W"x H"x D"	WT/LB	AVAILABLE STYLES
	W0936	09 x 36 x 12	22.0	DC CW CB FV PG SW
	W1236	12 x 36 x 12	26.0	DC CW CB FV PG SW
	W1536	15 x 36 x 12	31.0	DC CW CB FV PG SW
	W1836	18 x 36 x 12	34.0	DC CW CB FV PG SW
	W2136	21 x 36 x 12	38.0	DC CW CB FV PG SW
1 Door, 2 Adj. Shelves				

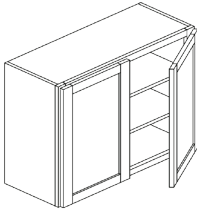
	ITEM CODE	W"x H"x D"	WT/LB	AVAILABLE STYLES
	W2436	24 x 36 x 12	40.0	DC CW CB FV PG SW
	W2736	27 x 36 x 12	44.0	DC CW CB FV PG SW
	W3036	30 x 36 x 12	49.0	DC CW CB FV PG SW
	W3336	33 x 36 x 12	53.0	DC CW CB FV PG SW
	W3636	36 x 36 x 12	56.0	DC CW CB FV PG SW
	W4236	42 x 36 x 12	65.0	DC CW CB FV PG SW
2 Doors, 2 Adj. Shelves				

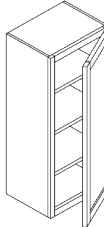
	ITEM CODE	W"x H"x D"	WT/LB	AVAILABLE STYLES
	W0942	09 x 42 x 12	27.0	DC CW CB FV PG SW
	W1242	12 x 42 x 12	31.0	DC CW CB FV PG SW
	W1542	15 x 42 x 12	35.0	DC CW CB FV PG SW
	W1842	18 x 42 x 12	40.0	DC CW CB FV PG SW
	W2142	21 x 42 x 12	45.0	DC CW CB FV PG SW
1 Door, 3 Adj. Shelves				

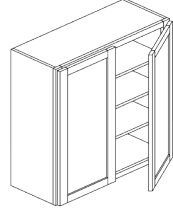
	ITEM CODE	W"x H"x D"	WT/LB	AVAILABLE STYLES
	W2442	24 x 42 x 12	49.0	DC CW CB FV PG SW
	W2742	27 x 42 x 12	53.0	DC CW CB FV PG SW
	W3042	30 x 42 x 12	59.0	DC CW CB FV PG SW
	W3342	33 x 42 x 12	64.0	DC CW CB FV PG SW
	W3642	36 x 42 x 12	67.0	DC CW CB FV PG SW
	W4242	42 x 42 x 12	81.0	DC CW CB FV PG SW
2 Doors, 3 Adj. Shelves				

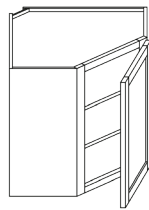
	ITEM CODE	W"x H"x D"	WT/LB	AVAILABLE STYLES
	WDC2430	24 x 30 x 12	45.0	DC CW CB FV PG SW
	WDC2436	24 x 36 x 12	50.0	DC CW CB FV PG SW
	WDC273615	27 x 36 x 15	57.0	DC CW CB FV PG SW
1 Door: 14 3/4" W, 2 Adj. Shelves				
Note: 24" Corner Cabinet: 12" Deep, 27" Corner Cabinet: 15" Deep				

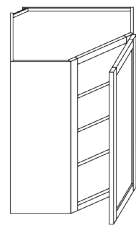
	ITEM CODE	W"x H"x D"	WT/LB	AVAILABLE STYLES
	WDC2442	24 x 42 x 12	60.0	DC CW CB FV PG SW
	WDC274215	27 x 42 x 15	62.0	DC CW CB FV PG SW
1 Door: 14 3/4" W, 3 Adj. Shelves				
Note: 24" Corner Cabinet: 12" Deep, 27" Corner Cabinet: 15" Deep				

Note: Specifications are subject to change without notice. Our style and product availability may vary slightly from those shown in this catalog.

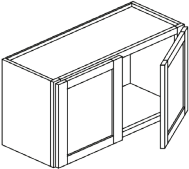
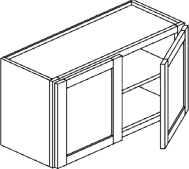
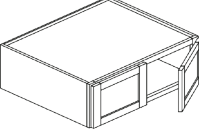

# WALL CABINETS

	ITEM CODE	W"x H"x D"	WT/LB	AVAILABLE STYLES
<b>WALL BRIDGE CABINET - NO SHELF - 30" W &amp; 36" W</b>				
	W3012	30 x 12 x 12	21.0	DC CW CB FV PG SW
	W3015	30 x 15 x 12	23.0	DC CW CB FV PG SW
	W3018	30 x 18 x 12	27.0	DC CW CB FV PG SW
	W3021	30 x 21 x 12	31.0	DC CW CB FV PG SW
	W3612	36 x 12 x 12	25.0	DC CW CB FV PG SW
	W3615	36 x 15 x 12	29.0	DC CW CB FV PG SW
	W3618	36 x 18 x 12	32.0	DC CW CB FV PG SW
	W3621	36 x 21 x 12	35.0	DC CW CB FV PG SW
2 Doors, No Shelf				
<b>WALL BRIDGE CABINET - 1 SHELF</b>				
	W3024	30 x 24 x 12	34.0	DC CW CB FV PG SW
	W3624	36 x 24 x 12	39.0	DC CW CB FV PG SW
2 Doors, 1 Shelf				
<b>WALL REFRIGERATOR CABINET - NO SHELF - 33" W</b>				
	W331227	33 x 12 x 27	38.0	DC CW CB FV PG SW
	W331527	33 x 15 x 27	40.0	DC CW CB FV PG SW
	W331827	33 x 18 x 27	43.0	DC CW CB FV PG SW
	W332127	33 x 21 x 27	44.0	DC CW CB FV PG SW
27" Deep, 2 Doors, No Shelf				

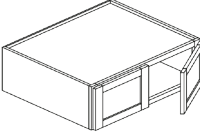
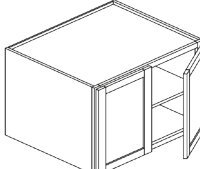
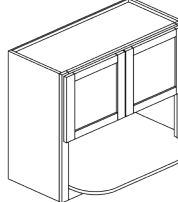
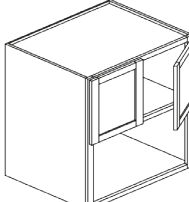
	ITEM CODE	W"x H"x D"	WT/LB	AVAILABLE STYLES
<b>WALL REFRIGERATOR CABINET - NO SHELF - 36" W</b>				
	W361227	36 x 12 x 27	38.0	DC CW CB FV PG SW
	W361527	36 x 15 x 27	42.0	DC CW CB FV PG SW
	W361827	36 x 18 x 27	46.0	DC CW CB FV PG SW
	W362127	36 x 21 x 27	47.0	DC CW CB FV PG SW
27" Deep, 2 Doors, No Shelf				
<b>WALL REFRIGERATOR CABINET - 1 SHELF</b>				
	W332427	33 x 24 x 27	49.0	DC CW CB FV PG SW
	W362427	36 x 24 x 27	55.0	DC CW CB FV PG SW
27" Deep, 2 Doors, 1 Adj. Shelf				
<b>WALL MICROWAVE CABINET - OPEN SHELF</b>				
	WM273012	27 x 30 x 12	36.0	DC CW CB FV PG SW
	WM273612	27 x 36 x 12	41.0	DC CW CB FV PG SW
	WM274212	27 x 42 x 12	45.0	DC CW CB FV PG SW
Cabinet Opening: 23 7/8" W x 15 3/4" H Shelf Depth: 18" 2 Doors, 1 Shelf  <i>Note: Matching Color Interior</i>				
<b>WALL MICROWAVE CABINET - BUILD IN</b>				
	WM303024	30 x 30 x 24	58.0	DC CW CB FV PG SW
	WM303624	30 x 36 x 24	61.0	DC CW CB FV PG SW
	WM304224	30 x 42 x 24	64.0	DC CW CB FV PG SW
Cabinet Opening: 26 3/4" W x 16 1/2" H 2 Doors  <i>Note: Matching Color Interior</i>				

PRODUCT SPECS

Note: Specifications are subject to change without notice. Our style and product availability may vary slightly from those shown in this catalog.



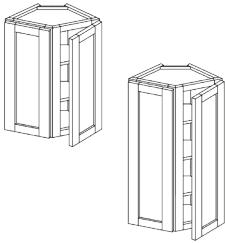
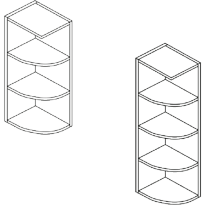
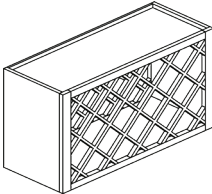
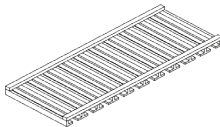

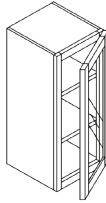
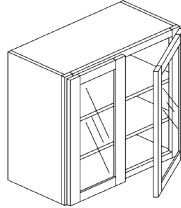
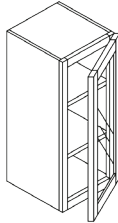
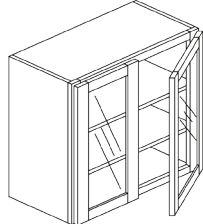
WALL CABINETS				
	ITEM CODE	W"x H"x D"	WT/LB	AVAILABLE STYLES
<b>WALL END CORNER</b>				
	WEC1230	12 x 30 x 12	23.0	DC CW CB FV PG SW
	WEC1236	12 x 36 x 12	26.0	DC CW CB FV PG SW
	WEC1242	12 x 42 x 12	30.0	DC CW CB FV PG SW
	Door Dimensions: 8 3/4" W 30" H & 36" H: 2 Adj. Shelves 42" H: 3 Adj. Shelves  2 Doors, 2 or 3 Shelves			
<b>WALL END OPEN SHELF (L/R)</b>				
	WES0930 L/R	09 x 30 x 12	16.0	DC CW CB FV PG SW
	WES0936 L/R	09 x 36 x 12	18.0	DC CW CB FV PG SW
	WES0942 L/R	09 x 42 x 12	21.0	DC CW CB FV PG SW
	30" H & 36" H: 2 Fixed Shelves 42" H: 3 Fixed Shelves Top Shelf: Square  Note: Matching Color Interior, Specify Left/Right When Ordering Assembled			
<b>WALL WINE RACK</b>				
	30WR	30 x 15 x 12	22.0	DC CW CB FV PG SW
	36WR	36 x 15 x 12	23.0	DC CW CB FV PG SW
	30WR: 14 Compartments 36WR: 16 Compartments			
<b>WALL GLASS RACK</b>				
	30GR	30 x 1.5 x 12	5.0	DC CW CB FV PG SW
	36GR	36 x 1.5 x 12	6.0	DC CW CB FV PG SW
	All Wood  Note: Matching Color Finish			

WALL GLASS CABINETS				
	ITEM CODE	W"x H"x D"	WT/LB	AVAILABLE STYLES
<b>WALL GLASS CABINET - 30" H</b>				
	W1530-GD	15 x 30 x 12	26.0	DC CW CB FV PG SW
	W1830-GD	18 x 30 x 12	27.0	DC CW CB FV PG SW
1 Door, 2 Adj. Wooden Shelves  Note: Door Center Panel Cutout, Matching Color Interior Glass Inserts & Shelves Sold Separately				
<b>WALL GLASS CABINET - 30" H</b>				
	W2430-GD	24 x 30 x 12	31.0	DC CW CB FV PG SW
	W2730-GD	27 x 30 x 12	37.0	DC CW CB FV PG SW
	W3030-GD	30 x 30 x 12	44.0	DC CW CB FV PG SW
	2 Doors, 2 Adj. Wooden Shelves  Note: Door Center Panel Cutout, Matching Color Interior Glass Inserts & Shelves Sold Separately			
<b>WALL GLASS CABINET - 36" H</b>				
	W1536-GD	15 x 36 x 12	30.0	DC CW CB FV PG SW
	W1836-GD	18 x 36 x 12	34.0	DC CW CB FV PG SW
1 Door, 2 Adj. Wooden Shelves  Note: Door Center Panel Cutout, Matching Color Interior Glass Inserts & Shelves Sold Separately				
<b>WALL GLASS CABINET - 36" H</b>				
	W2436-GD	24 x 36 x 12	39.0	DC CW CB FV PG SW
	W2736-GD	27 x 36 x 12	43.0	DC CW CB FV PG SW
	W3036-GD	30 x 36 x 12	50.0	DC CW CB FV PG SW
	2 Doors, 2 Adj. Wooden Shelves  Note: Door Center Panel Cutout, Matching Color Interior Glass Inserts & Shelves Sold Separately			

Note: Specifications are subject to change without notice. Our style and product availability may vary slightly from those shown in this catalog.

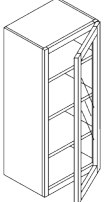
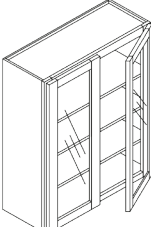
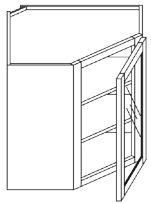
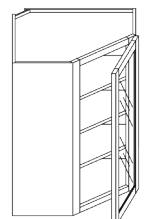
# WALL GLASS CABINETS

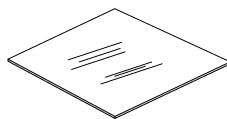
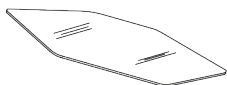
	ITEM CODE	W"x H"x D"	WT./LB	AVAILABLE STYLES
<b>WALL GLASS CABINET - 42" H</b>				
	W1542-GD	15 x 42 x 12	34.0	DC CW CB FV PG SW
	W1842-GD	18 x 42 x 12	36.0	DC CW CB FV PG SW
1 Door, 3 Adj. Wooden Shelves <b>Note:</b> Door Center Panel Cutout, Matching Color Interior Glass Inserts & Shelves Sold Separately				
<b>WALL GLASS CABINET - 42" H</b>				
	W2442-GD	24 x 42 x 12	48.0	DC CW CB FV PG SW
	W2742-GD	27 x 42 x 12	53.0	DC CW CB FV PG SW
	W3042-GD	30 x 42 x 12	59.0	DC CW CB FV PG SW
2 Doors, 3 Adj. Wooden Shelves <b>Note:</b> Door Center Panel Cutout, Matching Color Interior Glass Inserts & Shelves Sold Separately				
<b>WALL DIAGONAL CORNER GLASS CABINET - 30" &amp; 36" H</b>				
	WDC2430-GD	24 x 30 x 12	45.0	DC CW CB FV PG SW
	WDC2436-GD	24 x 36 x 12	51.0	DC CW CB FV PG SW
	WDC273615-GD	27 x 36 x 15	59.0	DC CW CB FV PG SW
Door Dimension: 14 3/4" W 1 Door, 2 Adj. Shelves <b>Note:</b> Door Center Panel Cutout, Matching Color Interior Glass Inserts & Shelves Sold Separately				
<b>WALL DIAGONAL CORNER GLASS CABINET - 42" H</b>				
	WDC2442-GD	24 x 42 x 12	59.0	DC CW CB FV PG SW
	WDC274215-GD	27 x 42 x 15	64.0	DC CW CB FV PG SW
Door Dimension: 14 3/4" W 1 Door, 3 Adj. Shelves <b>Note:</b> Door Center Panel Cutout, Matching Color Interior Glass Inserts & Shelves Sold Separately				

	ITEM CODE	W"x H"x D"	WT./LB	AVAILABLE STYLES
<b>STRAIGHT WALL GLASS CABINET SHELF - TEMPERED</b>				
	GS-15	13.5 x 10.5	4.0	DC CW CB FV PG SW
	GS-18	16.5 x 10.5	5.0	DC CW CB FV PG SW
	GS-24	22.5 x 10.5	6.5	DC CW CB FV PG SW
	GS-27	25.5 x 10.5	7.5	DC CW CB FV PG SW
	GS-30	28.5 x 10.5	8.5	DC CW CB FV PG SW
Tempered Glass, For Straight Cabinet <b>Note: Tempered Glass: Do Not Cut / Modify</b>				
<b>WALL DIAGONAL CORNER CABINET GLASS SHELF - TEMPERED</b>				
	GS-WDC24*12	N/A	11.5	DC CW CB FV PG SW
		N/A		
	GS-WDC27*15	N/A	15.5	DC CW CB FV PG SW
		N/A		
Tempered Glass, For Diagonal Corner Cabinets <b>Note: Tempered Glass: Do Not Cut / Modify</b>				
<b>CLEAR GLASS INSERT - TEMPERED</b>				
	GI-15/30*30-C	9 7/8 x 24 5/8	5.0	DC CW CB FV PG SW
	GI-18*30-C	12 7/8 x 24 5/8	5.0	DC CW CB FV PG SW
	GI-24*30-C	6 7/8 x 24 5/8	5.0	DC CW CB FV PG SW
	GI-27*30-C	8 7/16 x 24 5/8	5.0	DC CW CB FV PG SW
	GI-15/30*36-C	9 7/8 x 30 5/8	5.0	DC CW CB FV PG SW
	GI-18*36-C	12 7/8 x 30 5/8	5.0	DC CW CB FV PG SW
	GI-24*36-C	6 7/8 x 30 5/8	5.0	DC CW CB FV PG SW
	GI-27*36-C	8 7/16 x 30 5/8	5.0	DC CW CB FV PG SW
	GI-15/30*42-C	9 7/8 x 36 5/8	5.0	DC CW CB FV PG SW
	GI-18*42-C	12 7/8 x 36 5/8	5.0	DC CW CB FV PG SW
	GI-24*42-C	6 7/8 x 36 5/8	5.0	DC CW CB FV PG SW
	GI-27*42-C	8 7/16 x 36 5/8	5.0	DC CW CB FV PG SW
Clear Glass: Tempered <b>Note: Tempered Glass: Do Not Cut / Modify</b>				

PRODUCT SPECS

Note: Specifications are subject to change without notice. Our style and product availability may vary slightly from those shown in this catalog.

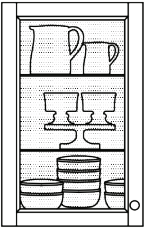

## WALL GLASS CABINETS

	ITEM CODE	W"x H"x D"	WT/LB	AVAILABLE STYLES
<b>FROSTED GLASS INSERT - TEMPERED</b>				
	GI-15/30*30-F	9 7/8 x 24 5/8	5.0	DC CW CB FV PG SW
	GI-18*30-F	12 7/8 x 24 5/8	5.0	DC CW CB FV PG SW
	GI-24*30-F	6 7/8 x 24 5/8	5.0	DC CW CB FV PG SW
	GI-27*30-F	8 7/16 x 24 5/8	5.0	DC CW CB FV PG SW
	GI-15/30*36-F	9 7/8 x 30 5/8	5.0	DC CW CB FV PG SW
	GI-18*36-F	12 7/8 x 30 5/8	5.0	DC CW CB FV PG SW
	GI-24*36-F	6 7/8 x 30 5/8	5.0	DC CW CB FV PG SW
	GI-27*36-F	8 7/16 x 30 5/8	5.0	DC CW CB FV PG SW
	GI-15/30*42-F	9 7/8 x 36 5/8	5.0	DC CW CB FV PG SW
	GI-18*42-F	12 7/8 x 36 5/8	5.0	DC CW CB FV PG SW
	GI-24*42-F	6 7/8 x 36 5/8	5.0	DC CW CB FV PG SW
	GI-27*42-F	8 7/16 x 36 5/8	5.0	DC CW CB FV PG SW
Frosted Glass: Tempered <b>Note: Tempered Glass: Do Not Cut / Modify</b>				

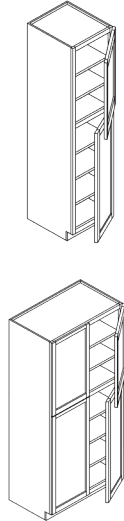
	ITEM CODE	W"x H"x D"	WT/LB	AVAILABLE STYLES
<b>TALL PANTRY CABINET - WITH SHELVES - 27" DEEP</b>				
	PC188427	18 x 84 x 27	123.0	DC CW CB FV PG SW
	PC189027	18 x 90 x 27	145.0	DC CW CB FV PG SW
	PC189627	18 x 96 x 27	166.0	DC CW CB FV PG SW
	PC248427	24 x 84 x 27	128.0	DC CW CB FV PG SW
	PC249027	24 x 90 x 27	150.0	DC CW CB FV PG SW
	PC249627	24 x 96 x 27	174.0	DC CW CB FV PG SW
	PC308427	30 x 84 x 27	132.0	DC CW CB FV PG SW
	PC309027	30 x 90 x 27	156.0	DC CW CB FV PG SW
	PC309627	30 x 96 x 27	181.0	DC CW CB FV PG SW
18" Wide: 2 Doors 24" & 30" Wide: 4 Doors 5 Shelves: 84" & 90" H 6 Shelves: 96" H Upper Doors: 29 1/2", 35 1/2", 41 1/2" H Bottom Doors: 49 1/8" H <b>Note: Roll Out Tray is Not Included</b>				

## TALL CABINETS

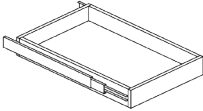
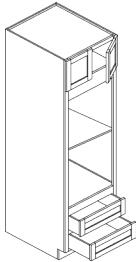
	ITEM CODE	W"x H"x D"	WT/LB	AVAILABLE STYLES	
<b>ROLL OUT TRAY - CLEAR COAT FINISH</b>					
	ROT15	10 7/8 x 4 x 22	4.0	DC CW CB FV PG SW	
	ROT18	13 7/8 x 4 x 22	4.5	DC CW CB FV PG SW	
	ROT21	16 7/8 x 4 x 22	4.5	DC CW CB FV PG SW	
	ROT24	19 7/8 x 4 x 22	5.0	DC CW CB FV PG SW	
	ROT27	22 7/8 x 4 x 22	6.0	DC CW CB FV PG SW	
	ROT30	25 7/8 x 4 x 22	6.5	DC CW CB FV PG SW	
	ROT33	28 7/8 x 4 x 22	7.0	DC CW CB FV PG SW	
	ROT36	31 7/8 x 4 x 22	8.0	DC CW CB FV PG SW	
	Dimensions: 4" H x 22" D Soft-Close Glides Availability: BBG18-S BBG21-S BBG24-S <b>Note: Clear Coat Finish, Specify Cabinet Depth for Glides</b>				
	<b>SINGLE OVEN CABINET - 27" DEEP</b>				
	SOC308427	30 x 84 x 27	165.0	DC CW CB FV PG SW	
	SOC309027	30 x 90 x 27	173.0	DC CW CB FV PG SW	
	SOC309627	30 x 96 x 27	181.0	DC CW CB FV PG SW	
	SOC338427	33 x 84 x 27	175.0	DC CW CB FV PG SW	
	SOC339027	33 x 90 x 27	183.0	DC CW CB FV PG SW	
	SOC339627	33 x 96 x 27	191.0	DC CW CB FV PG SW	
	30" Cab. Opening: 26 7/8" W x 38 3/8" H 33" Cab. Opening: 28 3/4" W x 38 3/8" H Top Drawer: 7" H Bottom Drawer: 10 7/8" H Upper Rail: 9 1/4" H Lower Rail: 1 9/16" H 2 Doors, 2 Drawers, 1 Adj. Shelf, 2 Sets Glides				

Note: Specifications are subject to change without notice. Our style and product availability may vary slightly from those shown in this catalog.

## TALL CABINETS

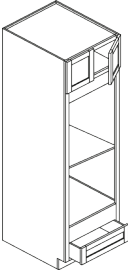
	ITEM CODE	W"x H"x D"	WT./LB	AVAILABLE STYLES
<b>DOUBLE OVEN CABINET - 27" DEEP</b>				
	DOC308427	30 x 84 x 27	145.0	DC CW CB FV PG SW
	DOC309027	30 x 90 x 27	150.0	DC CW CB FV PG SW
	DOC309627	30 x 96 x 27	160.0	DC CW CB FV PG SW
	DOC338427	33 x 84 x 27	154.0	DC CW CB FV PG SW
	DOC339027	33 x 90 x 27	160.0	DC CW CB FV PG SW
	DOC339627	33 x 96 x 27	170.0	DC CW CB FV PG SW
	30" Cab. Opening: 26 7/8" W x 43" H 33" Cab. Opening: 28 3/4" W x 43" H			
	Drawer: 10 7/8" H Upper Rail: 9 1/4" H Lower Rail: 5 3/8" H			
	2 Doors, 1 Drawer, 1 Adj. Shelf, 1 Set Glide			

### VANITY BASE CABINET

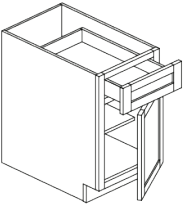
	VB15	15 x 34.5 x 21	42.0	DC CW CB FV PG SW
	VB18	18 x 34.5 x 21	44.0	DC CW CB FV PG SW
	VB21	21 x 34.5 x 21	49.0	DC CW CB FV PG SW
	1 Drawer, 1 Door, 1 Adj. Shelf, 1 Set Glide			

### VANITY DRAWER BASE CABINET

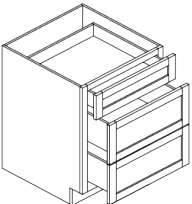
	VBD12-3	12 x 34.5 x 21	51.0	DC CW CB FV PG SW
	VBD15-3	15 x 34.5 x 21	59.0	DC CW CB FV PG SW
	VBD18-3	18 x 34.5 x 21	71.0	DC CW CB FV PG SW
	VBD21-3	21 x 34.5 x 21	78.0	DC CW CB FV PG SW
	VBD24-3	24 x 34.5 x 21	82.0	DC CW CB FV PG SW
	1 Small Drawer, 2 Large Drawers, 3 Sets Glides			

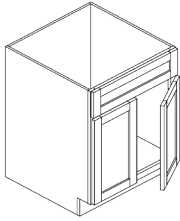
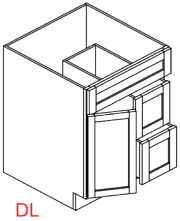
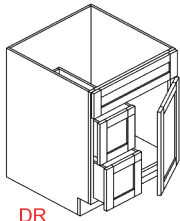
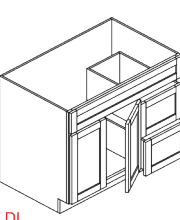

## VANITY CABINETS

	ITEM CODE	W"x H"x D"	WT./LB	AVAILABLE STYLES
<b>VANITY SINK BASE CABINET</b>				
	VSB24	24 x 34.5 x 21	39.0	DC CW CB FV PG SW
	VSB27	27 x 34.5 x 21	43.0	DC CW CB FV PG SW
	VSB30	30 x 34.5 x 21	46.0	DC CW CB FV PG SW
	1 Dummy Drawer 2 Doors No Shelf  <i>Note: Back Panel Not Cut for Plumbing</i>			
<b>VANITY SINK BASE - COMBO - DOOR ON THE LEFT</b>				
	VSB30DL	30 x 34.5 x 21	62.0	DC CW CB FV PG SW
	1 Dummy Drawer 2 Drawers: 12" W 1 Door on the <b>Left</b> No Shelf 2 Sets Glides  <i>Note: Back Panel Not Cut for Plumbing</i>			
<b>VANITY SINK BASE - COMBO - DOOR ON THE RIGHT</b>				
	VSB30DR	30 x 34.5 x 21	62.0	DC CW CB FV PG SW
	1 Dummy Drawer 2 Drawers: 12" W 1 Door on the <b>Right</b> No Shelf 2 Sets Glides  <i>Note: Back Panel Not Cut for Plumbing</i>			
<b>VANITY SINK BASE COMBO - DOOR ON THE LEFT</b>				
	VSB36DL	36 x 34.5 x 21	77.0	DC CW CB FV PG SW
	1 Dummy Drawer 2 Drawers: 12" W 2 Doors on the <b>Left</b> No Shelf 2 Sets Glides  <i>Note: Back Panel Not Cut for Plumbing</i>			

Note: Specifications are subject to change without notice. Our style and product availability may vary slightly from those shown in this catalog.

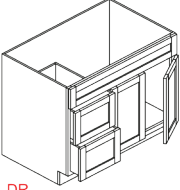
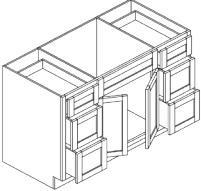
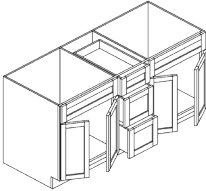
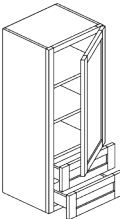

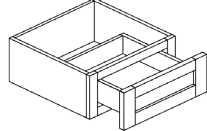
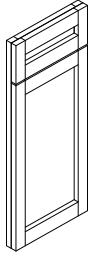
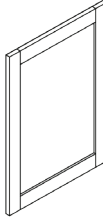
VANITY CABINETS				
	ITEM CODE	W"x H"x D"	WT/LB	AVAILABLE STYLES
<b>VANITY SINK BASE COMBO - DOOR ON THE RIGHT</b>				
 <p>DR</p>	VSB36DR	36 x 34.5 x 21	77.0	DC CW CB FV PG SW
	1 Dummy Drawer 2 Drawers: 12" W 2 Doors on the <b>Right</b> No Shelf 2 Sets Glides  <b>Note: Back Panel Not Cut for Plumbing</b>			
<b>VANITY SINGLE SINK COMBO - SINK IN THE MIDDLE</b>				
	VSB48D	48 x 34.5 x 21	126.0	DC CW CB FV PG SW
	VSB60D	60 x 34.5 x 21	139.0	DC CW CB FV PG SW
1 Dummy Drawer 6 Drawers: 12" W 2 Doors No Shelf 6 Sets Glides  <b>Note: Back Panel Not Cut for Plumbing</b>				
<b>VANITY DOUBLE SINK COMBO - DRAWER IN THE MIDDLE</b>				
	VSB60DD	60 x 34.5 x 21	132.0	DC CW CB FV PG SW
	2 Dummy Drawer 3 Drawers: 12" W 4 Doors No Shelf 3 Sets Glides  <b>Note: Back Panel Not Cut for Plumbing</b>			
<b>VANITY COUNTERTOP CABINET</b>				
	VCC12*44 1/2	12 x 44.5 x 12	31.0	DC CW CB FV PG SW
	1 Door: 29 1/2" H 2 Drawers: 7" H 2 Shelves 2 Sets Glides			

MOLDING & DECOR				
	ITEM CODE	W"x H"x D"	WT/LB	AVAILABLE STYLES
<b>KNEE DRAWER</b>				
	KDD24	24 x 8.5 x 21	29.0	DC CW CB FV PG SW
	KDD30	30 x 8.5 x 21	33.0	DC CW CB FV PG SW
Cabinet: 8 1/2" H 1 Drawer: 7" H 1 Set Glide				
<b>BASE DUMMY DOOR &amp; DRAWER</b>				
	B15F	15 x 30 x 1 1/2	8.0	DC CW CB FV PG SW
	B18F	18 x 30 x 1 1/2	9.0	DC CW CB FV PG SW
30" H, 1 1/2" Thick, Face Frame Attached				
<b>BASE END DUMMY DOOR</b>				
	BDD21	21 x 29.5 x 3/4	7.0	DC CW CB FV PG SW
	BDD24	24 x 29.5 x 3/4	8.0	DC CW CB FV PG SW
3/4" Thick, 29 1/4" Height				
<b>TALL DECORATIVE DOOR</b>				
	BDD8427	26 3/4 x 78 3/4 x 3/4	35.0	DC CW CB FV PG SW
	BDD9027	26 3/4 x 84 3/4 x 3/4	40.0	DC CW CB FV PG SW
	BDD9627	26 3/4 x 90 3/4 x 3/4	49.0	DC CW CB FV PG SW
1 Set: 4 Doors, 3/4" Thick, For Pantry/Oven/Ref. Side Panel				

Note: Specifications are subject to change without notice. Our style and product availability may vary slightly from those shown in this catalog.

# MOLDING & DECOR

	ITEM CODE	W"x H"x D"	WT/LB	AVAILABLE STYLES
--	-----------	------------	-------	------------------

## WALL DUMMY DOOR (PREDRILLED HINGE HOLES)

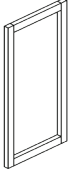
	W1230F	11 3/4 x 29.5 x 3/4	5.0	DC CW CB FV PG SW
	W1530F	14 3/4 x 29.5 x 3/4	7.0	DC CW CB FV PG SW
	W1830F	17 3/4 x 29.5 x 3/4	8.0	DC CW CB FV PG SW
	W2130F	20 3/4 x 29.5 x 3/4	9.0	DC CW CB FV PG SW
3/4" Thick, Predrilled Hinge Holes, Alternate Doors for Wall Cabinet				

## WALL DUMMY DOOR (PREDRILLED HINGE HOLES)

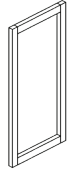
	W1236F	11 3/4 x 35.5 x 3/4	6.0	DC CW CB FV PG SW
	W1536F	14 3/4 x 35.5 x 3/4	8.0	DC CW CB FV PG SW
	W1836F	17 3/4 x 35.5 x 3/4	9.0	DC CW CB FV PG SW
	W2136F	20 3/4 x 35.5 x 3/4	11.0	DC CW CB FV PG SW
3/4" Thick, Predrilled Hinge Holes, Alternate Doors for Wall Cabinet				

## WALL DUMMY DOOR (PREDRILLED HINGE HOLES)

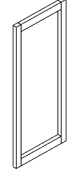
	W1242F	11 3/4 x 41.5 x 3/4	7.0	DC CW CB FV PG SW
	W1542F	14 3/4 x 41.5 x 3/4	9.0	DC CW CB FV PG SW
	W1842F	17 3/4 x 41.5 x 3/4	10.0	DC CW CB FV PG SW
	W2142F	20 3/4 x 41.5 x 3/4	12.0	DC CW CB FV PG SW
3/4" Thick, Predrilled Hinge Holes, Alternate Doors for Wall Cabinet				

## DISHWASHER PANEL

	DWR	1 9/16 x 34.5 x 24	11.0	DC CW CB FV PG SW
Return Filler: 1 9/16" W, Panel: 23 1/4" Wide, 5/8" Thick				
<b>Note: Toe Kick Not Included</b>				

	ITEM CODE	W"x H"x D"	WT/LB	AVAILABLE STYLES
--	-----------	------------	-------	------------------

## REFRIGERATOR PANEL

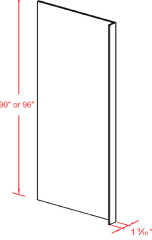
	RRP9027	27 x 90 x 5/8	26.0	DC CW CB FV PG SW
	RRP9627	27 x 96 x 5/8	28.0	DC CW CB FV PG SW
Return Filler: 1 9/16", Panel: 26 1/4" Wide, 5/8" Thick				

## BASE SKIN PANEL

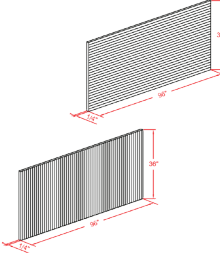
	BP3696 (SHORT GRAIN)	36 x 96 x 1/4	10.0	DC CW CB FV PG SW
	BP9636 (LONG GRAIN)	96 x 36 x 1/4	10.0	DC CW CB FV PG SW
Length: 96", Width: 36", Thickness: 1/4"				

## WOOD SHELF- MATCHING FINISH - 4 EDGE BANDED

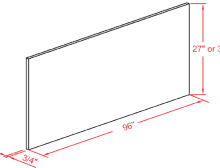
	WS27*96*3/4	27 x 96 x 3/4	18.0	DC CW CB FV PG SW
	WS36*96*3/4	36 x 96 x 3/4	29.0	DC CW CB FV PG SW
3/4" Thick, 4 Edge Banded, Matching finish				
<b>Note: No Return Filler</b>				

## ARCHED VALANCE - PLAIN 4 1/2" H

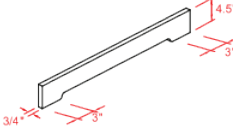
	VAL30-4 1/2	30 x 4.5 x 3/4	2.0	DC CW CB FV PG SW
	VAL36-4 1/2	36 x 4.5 x 3/4	2.0	DC CW CB FV PG SW
	VAL42-4 1/2	42 x 4.5 x 3/4	2.5	DC CW CB FV PG SW
	VAL48-4 1/2	48 x 4.5 x 3/4	2.5	DC CW CB FV PG SW
	VAL54-4 1/2	54 x 4.5 x 3/4	3.0	DC CW CB FV PG SW
	VAL60-4 1/2	60 x 4.5 x 3/4	3.5	DC CW CB FV PG SW
3/4" Thick, 4 1/2" Height				

Note: Specifications are subject to change without notice. Our style and product availability may vary slightly from those shown in this catalog.



# MOLDING & DECOR

PRODUCT SPECS

	ITEM CODE	W"x H"x D"	WT/LB	AVAILABLE STYLES
<b>ARCHED VALANCE - PLAIN 8" H</b>				
	VAL36-8	36 x 8 x 3/4	4.0	DC CW CB FV PG SW
	VAL42-8	42 x 8 x 3/4	5.0	DC CW CB FV PG SW
	VAL48-8	48 x 8 x 3/4	5.0	DC CW CB FV PG SW
	VAL54-8	54 x 8 x 3/4	6.0	DC CW CB FV PG SW
	VAL60-8	60 x 15 x 3/4	7.0	DC CW CB FV PG SW
3/4" Thick, 4 1/2" Height <b>Note: VAL60-8: 15" Height</b>				
<b>ARCHED VALANCE - RAISER PANEL 15" H</b>				
	VAL36-15	36 x 15 x 3/4	9.0	DC CW CB FV PG SW
	VAL42-15	42 x 15 x 3/4	9.0	DC CW CB FV PG SW
	VAL48-15	48 x 15 x 3/4	10.0	DC CW CB FV PG SW
	VAL54-15	54 x 15 x 3/4	10.0	DC CW CB FV PG SW
	VAL60-15	60 x 15 x 3/4	14.0	DC CW CB FV PG SW
3/4" Thick, 15" Height				
<b>POST - FULL TRADITIONAL TURNED POST</b>				
	PS3 X 34 1/2	3 x 34.5 x 3	4.0	DC CW CB FV PG SW
	3" Wide, 3" Deep, 34 1/2" H			
<b>POST - SQUARE POST</b>				
	SPS3 34 1/2	3 x 34.5 x 3	6.5	DC CW CB FV PG SW
	3" Wide, 3" Deep, 34 1/2" H			

	ITEM CODE	W"x H"x D"	WT/LB	AVAILABLE STYLES
<b>SMALL LEAF CORBEL</b>				
	SLC4 1/2 X 10	4.5 x 10.5 x 5	2.0	DC CW CB FV PG SW
	All Wood, Hand Carved			
<b>SMALL MISSION CORBEL</b>				
	SC4 1/2 x 10	4.5 x 10.5 x 5	3.0	DC CW CB FV PG SW
	All Wood, Hand Carved			
<b>BASE FILLER - TOE KICK ATTACHED</b>				
	BF3	3 x 34.5 x 3/4	1.5	DC CW CB FV PG SW
	BF6	6 x 34.5 x 3/4	3.0	DC CW CB FV PG SW
All Wood Filler, Toe Kick Attached, Matching Finish				
<b>WALL FILLER</b>				
	WF330	3 x 30 x 3/4	1.0	DC CW CB FV PG SW
	WF336	3 x 36 x 3/4	1.5	DC CW CB FV PG SW
	WF342	3 x 42 x 3/4	2.5	DC CW CB FV PG SW
	WF630	6 x 30 x 3/4	3.0	DC CW CB FV PG SW
	WF636	6 x 36 x 3/4	4.0	DC CW CB FV PG SW
	WF642	6 x 42 x 3/4	5.0	DC CW CB FV PG SW
All Wood Filler, Matching Finish				

Note: Specifications are subject to change without notice. Our style and product availability may vary slightly from those shown in this catalog.

# MOLDING & DECOR

ITEM CODE	W"x H"x D"	WT/LB	AVAILABLE STYLES
-----------	------------	-------	------------------

## TALL FILLER

	WF396	3 x 96 x 3/4	5.0	DC CW CB FV PG SW
	WF696	6 x 96 x 3/4	11.0	DC CW CB FV PG SW
<p>All Wood Filler, Matching Finish</p> <p>Note: WF396 Comes With Dado On The Back</p>				

## FACE FRAME FILLER

	FF8-1 9/16	96 x 1 9/16	3.0	DC CW CB FV PG SW
	<p>Length: 96", Width: 1 9/16", Thickness: 3/4"</p> <p>Note: Dado On The Back</p>			

## FLUTED FILLER - DECORATIVE FILLER

	RWF396	96 x 3	5.0	DC CW CB FV PG SW
	<p>Length: 96", Width: 3", Thickness: 3/4"</p> <p>Note: Dado On The Back</p>			

## CLASSIC CROWN MOLDING - NO BASE - SMALL

	CM8 - 2 1/8	96 x 2 1/8	5.0	DC CW CB FV PG SW
	<p>No Base, Length: 96", Height: 2 1/8", Depth: 1 3/4", Thickness: 3/4"</p>			

## CLASSIC CROWN MOLDING - NO BASE - LARGE

	CM8 - 3 3/4	96 x 3 3/4	7.0	DC CW CB FV PG SW
	<p>No Base, Length: 96", Height: 3 3/4", Depth: 3 7/8", Thickness: 3/4"</p>			

## CLASSIC CROWN MOLDING WITH BASE - SMALL

	CMB8 - 2 1/8	96 x 2 1/8	5.0	DC CW CB FV PG SW
	<p>Length: 96", Height: 2 1/8", Depth: 1 3/4", Thickness: 3/4"</p>			

## CLASSIC CROWN MOLDING - WITH BASE - LARGE

	CMB8 - 3 3/4	96 x 3 3/4	7.0	DC CW CB FV PG SW
	<p>Length: 96", Height: 3 3/4", Depth: 3 7/8", Thickness: 3/4"</p>			

## SHAKER COVE MOLDING - NO BASE - SMALL

	ST8 - 2 1/4	96 x 2 1/4	5.0	DC CW CB FV PG SW
	<p>Length: 96", Height: 2 1/4", Depth: 2 1/8", Thickness: 3/4"</p>			

Note: Specifications are subject to change without notice. Our style and product availability may vary slightly from those shown in this catalog.



# MOLDING & DECOR

PRODUCT SPECS

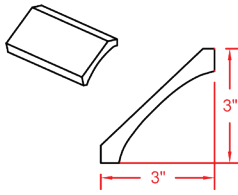
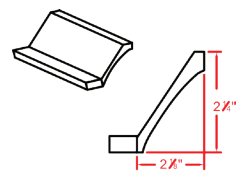
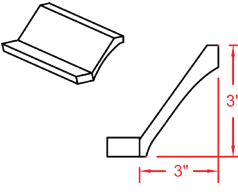
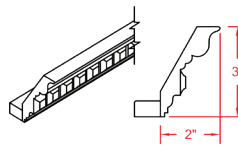
	ITEM CODE	W"x H"x D"	WT/LB	AVAILABLE STYLES
<b>SHAKER COVE MOLDING - NO BASE - LARGE</b>				
	STB8 - 3	96 x 3	5.5	DC CW CB FV PG SW
	Length: 96", Height: 3", Depth: 3", Thickness: 3/4"			
<b>SHAKER COVE MOLDING - WITH BASE - SMALL</b>				
	STB8 - 2 1/4	96 x 2 1/4	5.5	DC CW CB FV PG SW
	Length: 96", Height: 2 1/4", Depth: 2 1/8", Thickness: 3/4"			
<b>SHAKER COVE MOLDING - WITH BASE - LARGE</b>				
	STB8 - 3	96 x 3	6.0	DC CW CB FV PG SW
	Length: 96", Height: 3", Depth: 3", Thickness: 3/4"			
<b>DENTIL CROWN MOLDING</b>				
	DCM8 - 3	96 x 3	5.0	DC CW
	Length: 96", Height: 3", Depth: 2", Thickness: 3/4"			

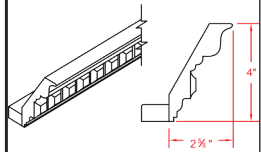
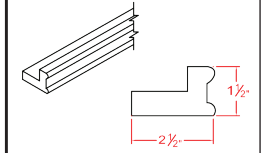
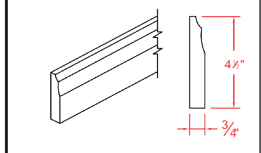
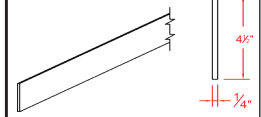
	ITEM CODE	W"x H"x D"	WT/LB	AVAILABLE STYLES
<b>DENTIL CROWN MOLDING</b>				
	DCM8 - 4	96 x 4	6.0	DC CW
	Length: 96", Height: 4", Depth: 2 5/8", Thickness: 3/4"			
<b>LIGHT RAIL MOLDING</b>				
	LRM8 - 1 1/2	96 x 1 1/2	4.5	DC CW CB FV PG SW
	Length: 96", Height: 1 1/2", Depth: 2 1/2", Thickness: 3/4"			
<b>BASE MOLDING</b>				
	BM8 - 4 1/2	96 x 4 1/2	5.5	DC CW CB FV PG SW
	Length: 96", Wide: 4 1/2", Thickness: 3/4"			
<b>TOE KICK / TOE PLATE</b>				
	TK8	96 x 4 1/2	2.0	DC CW CB FV PG SW
	Length: 96", Wide: 4 1/2", Thickness: 1/4"			

Note: Specifications are subject to change without notice. Our style and product availability may vary slightly from those shown in this catalog.

# MOLDING & DECOR

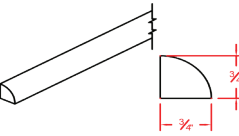
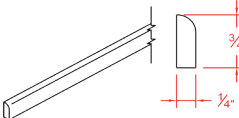
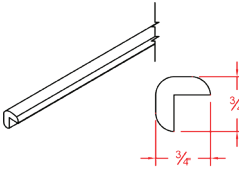
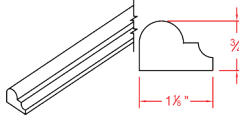
	ITEM CODE	W"x H"x D"	WT/LB	AVAILABLE STYLES
<b>QUARTER ROUND MOLDING</b>				
	QRM8	96 x 3/4	1.0	DC CW CB FV PG SW
	Length: 96", Wide: 3/4", Thickness: 3/4"			
<b>SCRIBE MOLDING / TRIM MOLDING</b>				
	SM8	96 x 1/4	1.0	DC CW CB FV PG SW
	Length: 96", Wide: 3/4", Thickness: 1/4"			
<b>OUTSIDE CORNER MOLDING</b>				
	OCM8	96 x 3/4	1.0	DC CW CB FV PG SW
	Length: 96", Wide: 3/4", Thickness: 1/4"			
<b>CHAIR RAIL MOLDING</b>				
	CRM8	96 x 1 1/8	1.0	DC CW CB FV PG SW
	Length: 96", Wide: 1-1/8", Thickness: 3/4"			

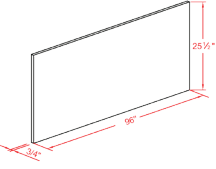
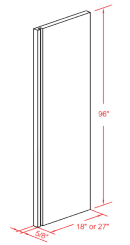
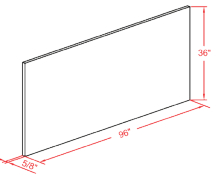
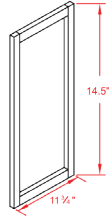
	ITEM CODE	W"x H"x D"	WT/LB	AVAILABLE STYLES
<b>PART-CABINET WOOD SHELF - CLEAR COAT FINISH</b>				
	Part-WS25.5*96	5.5 x 96 x 3/4	36.0	DC CW CB FV PG SW
	Wood Shelf, Clear Coat Finish, Edge Banded			
<b>PART - CABINET SIDE PANEL - DADOED FOR BACK PANEL</b>				
	CSP18*96	18 x 96 x 5/8	17.0	DC CW CB FV PG SW
	CSP27*96	27 x 96 x 5/8	26.0	DC CW CB FV PG SW
One Side: Clear Coat Finish, Another Side: Matching Finish, Back Panel: Dadoed <b>Note: Use For Modifying or Increasing Cabinet Depth</b>				
<b>PART - CABINET BOTTOM PANEL</b>				
	CBP36*96	36 x 96 x 5/8	35.0	DC CW CB FV PG SW
	One Side: Clear Coat Finish, Another Side: Matching Finish <b>Note: Use For Modifying or Increasing Cabinet Depth</b>			
<b>SAMPLE DOOR</b>				
	SAMPLE DOOR	11 3/4 x 14.5 x 3/4	2.0	DC CW CB FV PG SW
	Width: 11 3/4", Height: 14 1/2"			



Note: Specifications are subject to change without notice. Our style and product availability may vary slightly from those shown in this catalog.





PRODUCT SPECS











# ACCESSORIES

ITEM CODE	W"x H"x D"	WT/LB	AVAILABLE STYLES
-----------	------------	-------	------------------



SAMPLE MOLDING				
	SAMPLE MOLDING		1.0	
	Assorted Molding, 4" - 6" /ea.			



TOUCH UP KIT				
	WAX STICK		0.1	
	MARKER PEN		0.1	
	STAIN/LACQUER	4 OZ. CAN	0.6	
Wax stick, Marker pen, Stain/lacquer				



DRAWER GLIDE - FULL EXTENSION - SOFT CLOSE - UNDERMOUNT				
	UMFE 15-S	For 18" D CAB.	5.0	
	UMFE 18-S	For 21" D CAB.	5.0	
	UMFE 21-S	For 24" D CAB.	6.0	
	UMFE 24-S	For 27" D CAB.	6.5	
Undermount, Steel, Capacity up to 100 lbs.				



DRAWER GLIDE - FULL EXTENSION - SOFT CLOSE - BALL BEARING SIDE MOUNT				
	BBG18-S	For 21" D CAB.	5.0	
	BBG21-S	For 24" D CAB.	5.5	
	BBG24-S	For 27" D CAB.	6.0	
Ball Bearing Glide: Side Mount, Steel, Capacity up to 100 lbs.				

ITEM CODE	W"x H"x D"	WT/LB	AVAILABLE STYLES
-----------	------------	-------	------------------

HINGE				
	101-Hinge-6W		0.3	
	Metal, Concealed, Soft-Close, 6-Way Adj.			





HINGE - LAZY SUSAN - BI-FOLDING DOORS				
	102-Hinge-LS-BI		0.1	
	Metal, Concealed, Non-Soft-Close, For Lazy Susan Bi-Folding Doors			



HINGE-LAZY SUSAN - FACE FRAME & DOOR				
	103-Hinge-LS-DF		0.4	
	Metal, Concealed, Non-Soft Close, Connecting Lazy Susan Door & Frame			

HINGE-UPWARD OPENING				
	103-Hinge-Upward	Pneumatic Lift	0.4	
	Color: Silver, Pneumatic Support			

Note: Specifications are subject to change without notice. Our style and product availability may vary slightly from those shown in this catalog.

# ACCESSORIES

	ITEM CODE	W"x H"x D"	WT./LB	AVAILABLE STYLES
<b>LAZY SUSAN TURN PLATE</b>				
	201-LS-TP	6" x 6"	0.3	DC CW CB FV PG SW
	Metal - Black, Lazy Susan Turn Plate			
<b>SHELF REST</b>				
	202-Shelf Rest	3/16" HOLE	0.1	DC CW CB FV PG SW
	Metal Shelf Holder With Thread, Clear Glass Shelf Suction Cup			
<b>DOOR BUMPER</b>				
	203-Bumper		0.1	DC CW CB FV PG SW
	Clear Door Bumper			
<b>RETAINER CLIP</b>				
	204-GI-Clip		0.1	DC CW CB FV PG SW
	Glass Door Retainer Clip For Wall Glass Cabinet Insert			

	ITEM CODE	W"x H"x D"	WT./LB	AVAILABLE STYLES
<b>L - BRACKET - 90 DEGREE</b>				
	205-L Bracket	2 1/4" x 2 1/4"	0.1	DC CW CB FV PG SW
	Metal, 7/8" x 2-1/8" x 2-1/8"			
<b>TRASH BIN - PLASTIC</b>				
	206-Trash Bin	12 3/4 x 14 x 6 3/4	2.0	DC CW CB FV PG SW
	Gray - 6 Gallon <i>Note: Use It For BWBK18-2</i>			
<b>SMALL BRACKET SILVER</b>				
	207-Small Bracket	3/4" x 3/4"	0.1	DC CW CB FV PG SW
	Metal, 3/4" x 3/4"			

PRODUCT SPECS

Note: Specifications are subject to change without notice. Our style and product availability may vary slightly from those shown in this catalog.



# KITCHEN STANDARD SIZE AND ITEM CODE

WM303024  
WM303624  
WM304224

W331227  
W331527  
W331827  
W332127  
W332427

W361227  
W361527  
W361827  
W362127  
W362427

W0930  
W0936  
W0942

W1230 W1830  
W1236 W1836  
W1242 W1842

W1530 W2130  
W1536 W2136  
W1542 W2142

W3012  
W3015  
W3018  
W3021  
W3024

W2430 W3330  
W2436 W3336  
W2442 W3342

W2730 W3630  
W2736 W3636  
W2742 W3642

W3030 W4230  
W3036 W4236  
W3042 W4242

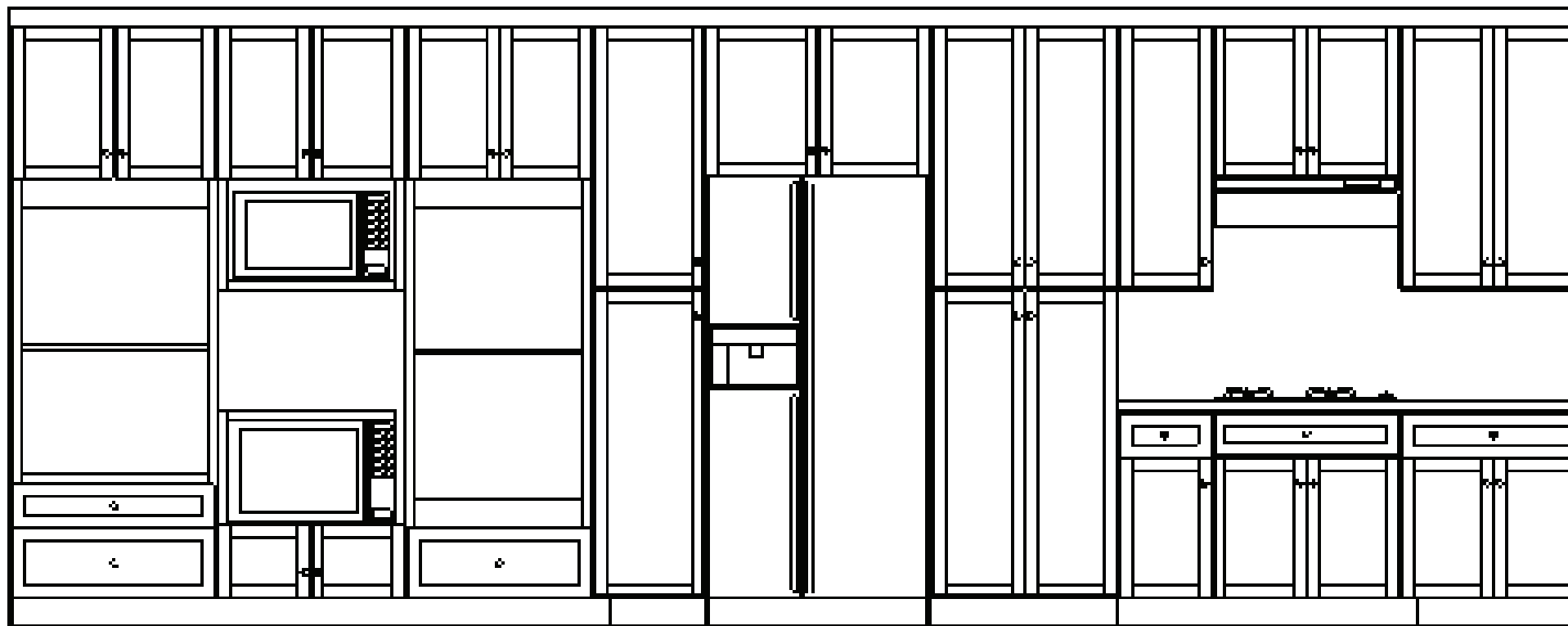

SOC308427  
SOC309027  
SOC309627

WM303024

DOC308427  
DOC309027  
DOC309627

PC188427  
PC189027  
PC189627

PC248427  
PC249027  
PC249627

B09  
B12  
B15  
B18  
B21

SB30

B24  
B27  
B30

SOC338427  
SOC339027  
SOC339627

DOC338427  
DOC339027  
DOC339627

PC308427  
PC309027  
PC309627

0  
6  
2  
  
0  
6  
2  
  
0  
6  
2

WM273012  
WM273612  
WM274212

W1530-GD  
W1536-GD  
W1542-GD

W1830-GD  
W1836-GD  
W1842-GD

W3612  
W3615  
W3618  
W3621  
W3624

W2430-GD  
W2436-GD  
W2442-GD

W2730-GD  
W2736-GD  
W2742-GD

W3030-GD WES0930 WEC0930  
W3036-GD WES0936 WEC0936  
W3042-GD WES0942 WEC0942

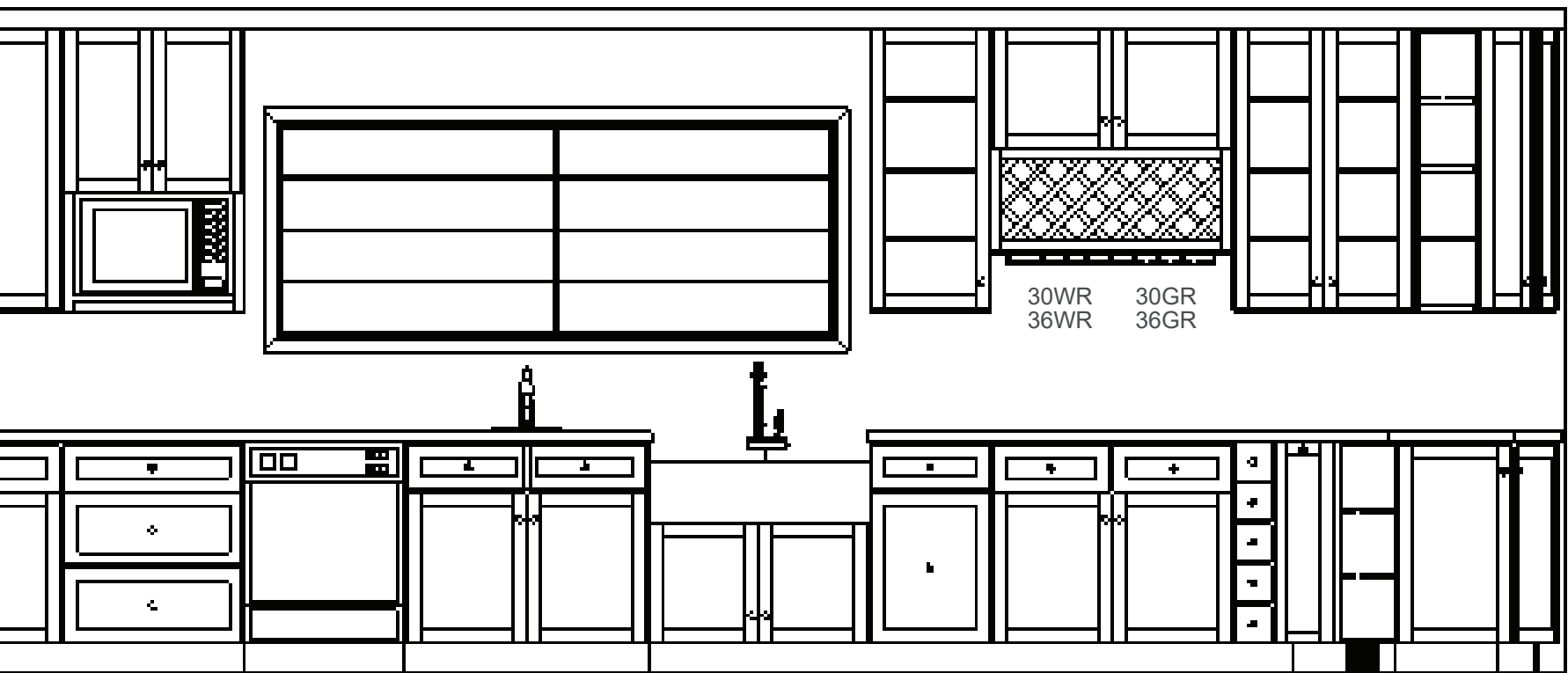

30WR 30GR  
36WR 36GR

DB12-3  
DB15-3  
DB18-3  
DB21-3  
DB24-3  
DB27-3  
DB30-3  
DB33-3  
DB36-3

SB33  
SB36  
SB42

W331827

BWBK18-2

B33  
B36  
B42

BSD06

BSP09

BES09

BEC24



# VANITY CONCEPT



45"  
VBD12-3 + VB21 + VBD12-3



48"  
VSB48D



54"  
VBD15D-3 + VSB24 + VB15

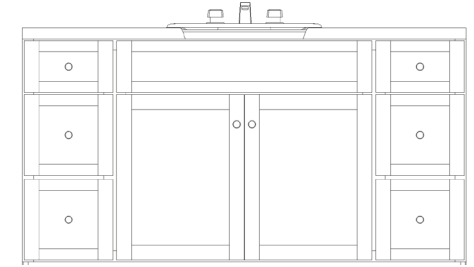

60"  
VSB60D

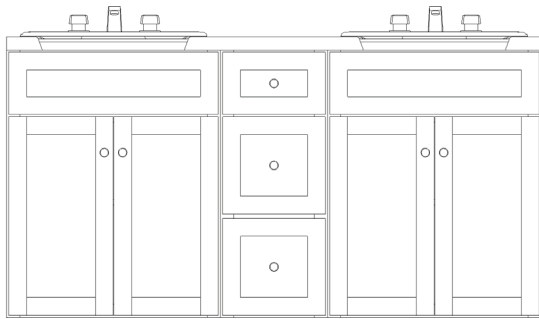

60"  
VSB60DD

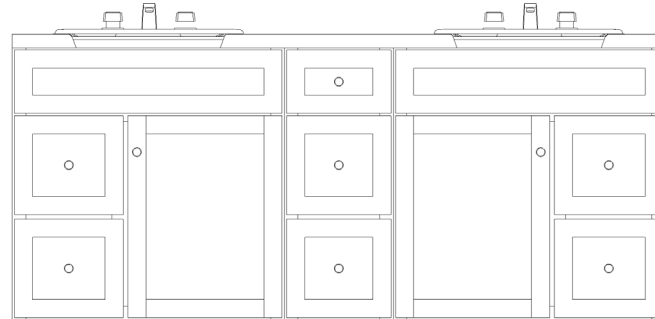

72"  
VSB30DR + VBD12-3 + VSB30DL

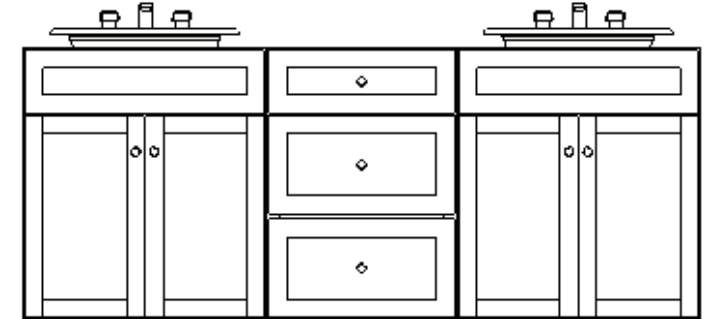

75"  
VSB27 + VBD21D-3 + VSB27

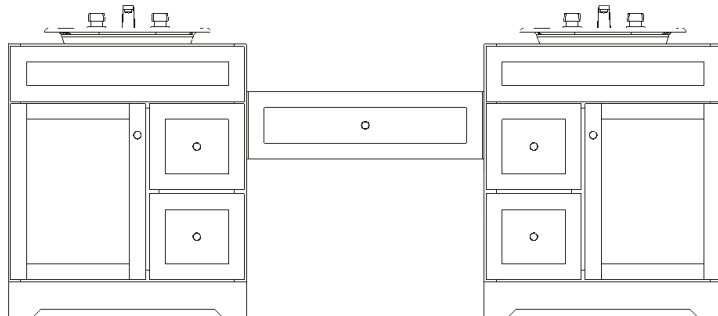

90"  
VSB30DL + KDD30 + VSB30DR

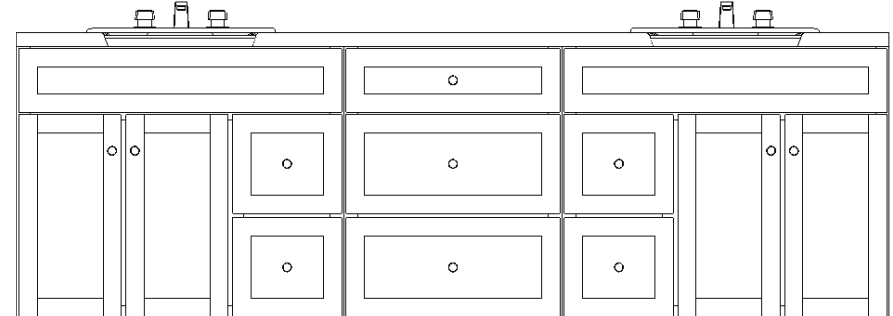

96"  
VSB36DL + VBD24-3 + VSB36DR

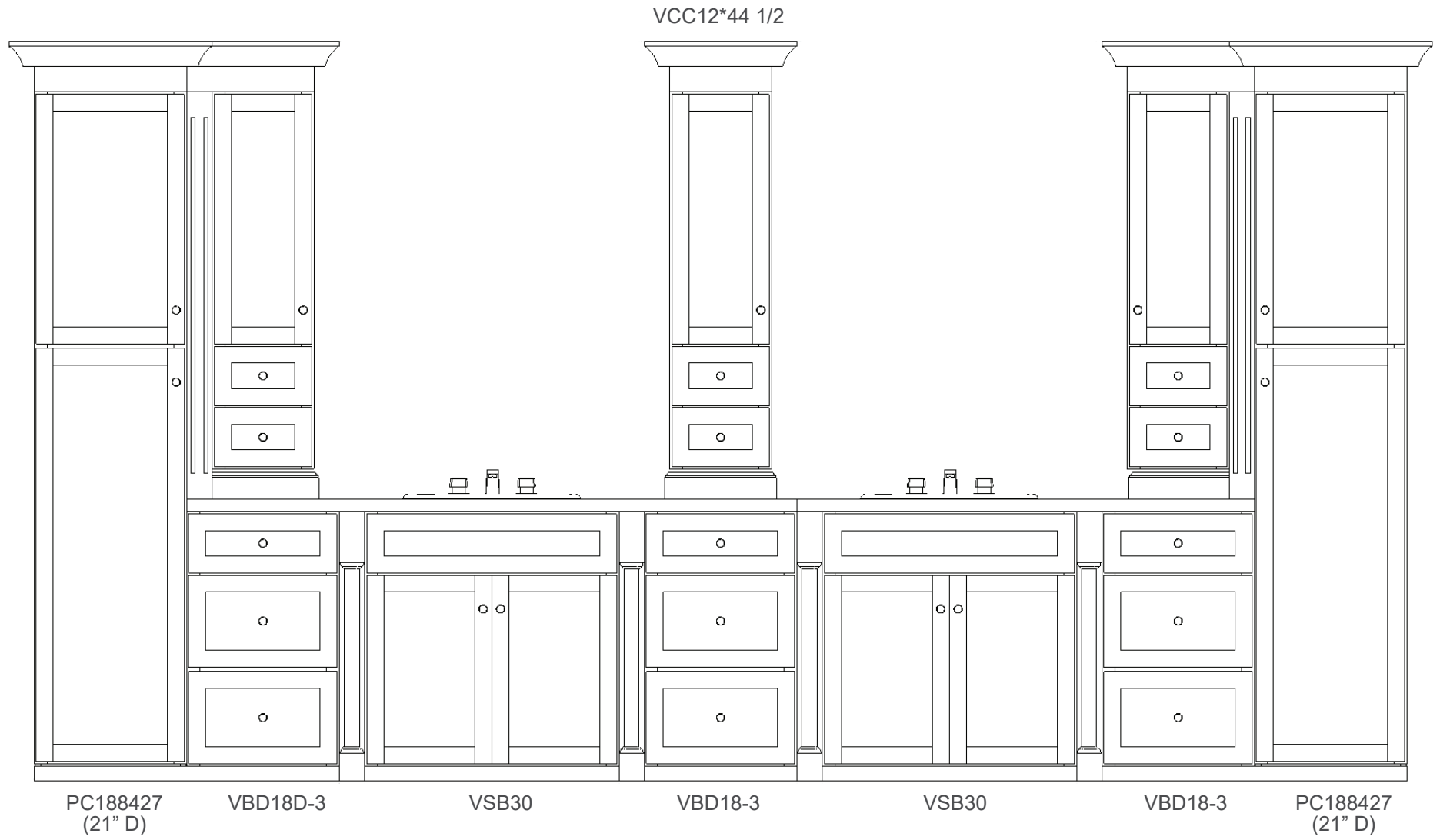



# SPECIAL ORDER SINKS



**Model: SS SM3118**

**Single Bowl Stainless Steel Kitchen Sink**

Product Features:

Style: Under Mount

Steel Thickness: 18 Gauge



**Model: SS AP3322D-A**

**Double Bowl Stainless Steel Apron Sink 50/50**

Product Features:

Style: Under Mount

Steel Thickness: 18 Gauge



**Model: SS SM502**

**Double Bowl Stainless Steel Kitchen Sink 50/50**

Product Features:

Style: Under Mount

Steel Thickness: 18 Gauge



**Model: Sink 208**

**Oval Shape Ceramic Bathroom Sink**

Product Features:

Style: Under Mount

Color: White



**Model: SS SM503R**

**Double Bowl Stainless Steel Kitchen Sink 60/40**

Product Features:

Style: Under Mount

Steel Thickness: 18 Gauge



**Model: Sink 2013**

**Rectangular Ceramic Bathroom Sink**

Product Features:

Style: Under Mount

Color: White



**Model: SS AP3322C-33**

**Single Bowl Stainless Steel Apron Sink**

Product Features:

Style: Under Mount

Steel Thickness: 18 Gauge

Note: Absolutely no returns or exchanges can be made on any special orders. Specifications are subject to change without notice. Our style & product availability may vary slightly from those shown in this catalog.

# LIMITED WARRANTY FOR ONE YEAR



## Warranty.

National Kitchen & Bath Cabinetry, also known as NKBC warrants that all cabinets sold by NKBC are free from defects in material and workmanship under normal use for a period of one year (1) limited warranty from the date of purchase. This warranty is only applicable to products used in residential applications and is not transferable to subsequent owners. This warranty shall become void if the cabinets are in any way modified, improperly assembled, installed or damaged prior to or during the installation. Furthermore, this warranty will not apply to cabinets damaged by misuse, neglect, abuse, exposure to moisture, exposure to extreme temperatures or the effects of normal wear and tear.

## Variations and Environmental Exposures Not Covered.

By purchasing our product, the original purchaser acknowledges that natural woods may vary in color, characteristics and exhibit subtle changes as they age. Sunlight, smoke, moisture, household cleaners and other environmental conditions may also affect the color match, or cause the materials to warp, split, or crack over time. These variations are considered to be the nature of the material in relation to their environmental exposure and are not covered under this warranty.

## Updated Product Lines.

NKBC periodically updates and makes changes to its product line and specifications. If a warranty claim is filed after a NKBC product becomes obsolete, NKBC reserves the right to alter specifications and material without obligation to make similar changes to products previously manufactured. NKBC will replace the part under warranty with a new part of the same style or with a similar style currently offered, but NKBC cannot guarantee that the finish of these replacements will exactly match the finish and appearance of the components in the residential application. This is due to the changes that occur during the woods natural aging process, affecting its color and grain.

## Disclaimers.

*THIS WARRANTY IS THE EXCLUSIVE WARRANTY OF NATIONAL KITCHEN & BATH CABINETRY AND IS IN LIEU OF AND NATIONAL KITCHEN & BATH CABINETRY DISCLAIMS ALL OTHER WARRANTIES, EXPRESSED OR IMPLIED, INCLUDING THE IMPLIED WARRANTIES OF MERCHANTABILITY AND FITNESS FOR A PARTICULAR PURPOSE.*

## Non-Transferability of Warranty.

NKBC's warranty is non-transferable to end-users, including consumers and homeowners who purchase NKBC products through the original purchaser. Any and all end-user warranty claims must be handled through and by the original purchaser, which may independently provide warranties to the end-user. Where the original purchaser, through its independent warranty with an end-user, is liable for a claim that would otherwise have been covered by NKBC's warranty to the original purchaser but for its non-transferability.

## Submitting a Claim.

To obtain replacement(s) under this limited warranty, the original purchaser must contact the NKBC office or warehouse from which the product was purchased. A payment receipt or paid invoice as proof of purchase is required to obtain benefits from this warranty, dated no earlier than one year (1) from the date of warranty claim and (2) if the claim is from an end user, first contact your authorized NKBC dealer or distributor, who will arrange for inspection of the cabinet. A copy of the end-user's the original purchaser payment receipt is required, dated no earlier than one year (1) from the date of warranty claim.









EXCLUSIVE DOOR STYLE

## CHARCOAL GRAY



Note: Call to check for availability.



NATIONAL KITCHEN & BATH  
C A B I N E T R Y



## North Carolina

7040B Northwinds Dr. NW  
Concord, NC 28027

sales@nkbcinc.com  
P: 704-652-7488  
F: 704-652-7489

www.nkbcinc.com



## Texas

2121 Scarbrough Dr. Suite 450  
Austin, TX 78728

sales@nkbctx.com  
P: 737-777-0555  
F: 737-777-0556

www.nkbctx.com



## Illinois

1811 W Normantown Rd  
Romeoville, IL 60446

info@nkbcil.com  
P: 815-733-8888  
F: 815-524-4263

www.nkbcil.com



*The photography and color samples shown in this catalog have been reproduced as accurately as printing technologies permit and are for representation only.  
To ensure the highest satisfaction, we strongly recommend you view an actual product sample prior to ordering cabinetry.*