



Our further products to be found
in the special catalogues:

*Nuestros Productos adicionales
se encuentran en los catálogos especializados:*

Os nossos outros produtos poderão
ser encontrados nos catálogos especiais:

General Collection

LiGHT Collection

WORK+FASHION Collection

Brakes and wheels
Frenos y ruedas
Travões e rodas

1

Gear, steering and suspension
Transmisión, dirección y suspensión
Transmissão, direção e suspensão

2

Engine tools
Útiles automoción
Ferramenta de motor

Gasoline
Gasolina
Gasolina

Diesel
Diesel
Diesel

Oil
Aceite
Óleo

Cooling
Refrigeración
Refrigeração

Engine adjustment
Ajuste motor
Ajuste motor

3

Body work, Installation / Removal tools
Útiles carrocería
Ferramenta de carrossaria

4

Testing / Diagnosis equipment
Equipamiento diagnóstico / testado
Equipamento de teste / diagnóstico

5

Electric tools
Herramientas eléctricas
Ferramenta de electricista

6

Motorcycle tools
Útiles motocicleta
Ferramenta para motos

7

General tools
Herramienta general
Ferramenta universal

8

Automotive



1

Brakes and wheels
Frenos y ruedas
Travões e rodas

Universal caliper brake piston rewind tool case

for resetting (pressing or rewinding) of left and right hand threaded brake pistons, even if linings are extremely worn out. Numbered adaptors for most popular car models.

Estuche reposicionador manual de pistones de freno

Para rotar y retroceder pistones de mordaza de freno de disco con o sin el mecanismo de freno de mano. Adaptadores para los modelos más usuales.

Jogo universal reposicionador de pistões de travões

para comprimir e reposicionar os pistões com rotação esquerdos e direitos, mesmo quando muitos desgastados. Adaptadores numerados para os modelos de carros mais populares.

Art.	
30203	Alfa, Audi, BMW, Citroën, Fiat, Ford, GM, Honda, Jaguar, Lancia, Mazda, Mitsubishi, Nissan, Opel, Peugeot, Renault, Rover, Saab, Seat, Subaru, Toyota, Volvo, VW



Info
KRAFTWERKtools.com/info/30203

40
PCS



415 x 355 x 85 mm

Brake pressure test case

for diagnosis of the brake system (including ABS-systems)

Juego comprobador de repartidor de frenada

Para la diagnosis del sistema de frenado (incluido ABS)

Jogo testa pressão de travões

para diagnostico dos sistemas de travagem (incluindo sistemas ABS)

Art.	
31105	0-3000 psi 0-200 kg/cm ²

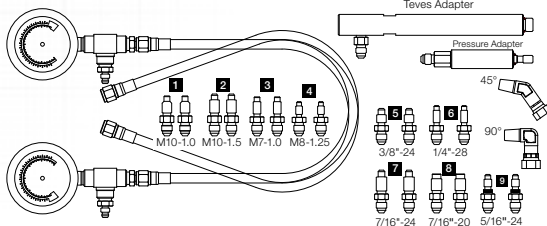

595 x 265 x 60 mm

Pneumatic spindel

for brake caliper rewind tools (also for case 30203)

Retractor neumático de pistones de frenos

para juegos de retractor de pistones de frenos (también por maletín 30203)

Reposicionador pneumático

para ferramentas de reposicionar pistões de travões (tambem para o jogo 30203)

1/4"	BSP	5-8	74

Art.
30202T



Pneumatic brake caliper rewind tool case

with pneumatic spindel, for rewinding and pressing the left and right hand threaded brake pistons, with 15 most popular and numbered adaptors.

Estuche reposicionador neumático de pistones de freno

con pistola neumática, para introducir y girar el pistón del freno a la derecha y la izquierda. Con 15 adaptadores numerados para los modelos más usuales.

Jogo de reposicionadores de pistões travões pneumático

para comprimir e reposicionar os pistões com rotação esquerda e direita nos discos de travão, com 15 adaptadores numerados para os modelos mais populares.

Art.	
30202	Alfa, Audi, BMW, Citroën, Fiat, Ford, GM, Honda, Isuzu, Jaguar, Lancia, Mazda, Mercedes, Mitsubishi, MINI, Nissan, Opel, Peugeot, Renault, Rover, Saab, Seat, Subaru, Toyota, Volvo, VW



Info
KRAFTWERKtools.com/info/30202



✚ 350 × 310 × 95 mm

Universal caliper brake piston rewind tool case

with 2 pin- and 3 pin-adaptor for most of the car brands

Estuche universal reposicionador pistones de freno

con discos de 2 y 3 puntos para la mayoría de los coches

Retractor de pistons de travões universal

com adaptador de 2 pinos e 3 pinos para maior parte dos fabricantes automóveis



Art.	
30224	Alfa Romeo 164 2/0, Ford / Mazda, Saab 9000, Subaru, Nissan Primera, VW-Golf IV, Audi 80/90, V8 +100, Ford Sierra ABS+ Scorpio ab 85, Honda Prelude, Nissan Silvia 1.8 turbo, Rover 8000, Saab 9000, Subaru L+Z, VW-Golf + Passat, Ford, Opel, Audi, BMW, Ford, Lancia, Proton, Renault, Rover, VW, Peugeot 307/308, Iveco Daily, VW Passat 2.0 TDI 09-, Renault Laguna



✚ 210 × 150 × 50 mm

Fuel & air conditioning line disconnect set
Juego de desconexión de tubos de aire acondicionado y combustible
 Jogo de desconectores tubos ar-condicionado e combustivel

21
PCS



310 × 240 × 60 mm

Art.
30602

inch			
	5/16"	Most cars	
	3/8"		
	1/2"		
	5/8"		
	3/4"		
	7/8"	Chrysler & Jeep; Ford 1981-	
	3/8"		
	1/2"		
	5/8"	Chrysler; Ford; GM	
	3/4"		
	1/4"		
	5/16"		
	3/8"		
	1/2"	Chrysler; Ford; GM	
	5/8"		
	3/4"		
	7/8"	Chrysler; Ford; GM	
	5/16"		
	3/8"		
			Buick Riviera & Regatta; Cadillac Eldorado; Ford CF1; GM pickup 1989- (1/2 t, 3/4 t, 1 t); Seville & Concours 1989; Tornado 1987-
			Ford 1983-; Lincoln Continental 1982
			Ford Rangers 1990- Ford Explorer 4.0 L 6 Cylinder engines

KETOS® CONTROL

KETOS Control Brake disc control device

No removal of the wheel, one-handed operation, automatic saving of the weakest spot, direct display indication, suitable for all types of vehicles, recalibratable.

KETOS Control instrumento para inspección de los discos de freno

Sin necesidad de desmontar la rueda, utilización con una sola mano, memoriza automáticamente el punto más débil, lectura directa en despliegue, apto para todo tipo de vehículos, re-calibrable.

KETOS instrumento de controle para inspeção dos discos de travão

sem necessidade de desmontar a roda, utilização com apenas uma mão, memoriza automaticamente o ponto mais débil, leitura directa no indicador, apto para todos os tipos de veiculo, recalibrado.



Art.	L mm
30005	188



Video

[KRAFTWERKtools.com/video/30005](https://www.kraftwerktools.com/video/30005)

Brake caliper brush

with steel wire

Cepillo para frenos

con alambre de acero

Escova para pinça do travões

com fio de aço

Art.	L mm
30209	220



Brake caliper file

Lima para frenos

Lima para pinça do travões

Art.	L1 mm	L2 mm
30210	150	260



Brake repair kit

for repairing the guide pin threads in the wheel bearing housing

Kit reparación de roscas

para reparación del soporte de pinza de frenos

Kit reparação de travões

para reparar as guias roscadas no cubo de rolamento da roda

Art.	
30216	M9 x 1.25



Engine cylinder hone

3 legs, equipped with replaceable stones

Lapeador de cilindros autocentrable

3 brazos, equipado con piedras cambiables

Despolidor de cilindros

3 pernas, equipado com pedras substituíveis

Art.	Ø mm	
30211	19-69	3 x 28.8 mm

Engine cylinder hone

3 legs, equipped with replaceable stones

Lapeador de cilindros autocentrable

3 brazos, equipado con piedras cambiables

Despolidor de cilindros

3 pernas, equipado com pedras substituíveis

Art.	Ø mm	
30610	51-177	3 x 102 mm

16
PCS



± 216 x 133 x 57 mm

1/4"

Medium



1/4"

Medium



4-in-1 cylinder hone kit



2- and 3 legs, for 4 different applications, equipped with replaceable stones

Kit de lapeadores de cilindros 4-en-1

2 y 3 brazos, para 4 aplicaciones diferentes, equipado con piedras cambiables

Kit despolidores de cilindros 4-en-1

2 e 3 pernas, para quatro aplicações diferentes, equipado com pedras substituíveis

Art.		∅ mm	
30212		18-63	2 × 28.8 mm
		22-69	3 × 28.8 mm
		32-89	3 × 19 mm
		32-89	3 × 51 mm



↕ 220 × 90 × 45 mm

Hone stone set for 30610

Set piedras para lapeador para 30610

Kit pedras despolidor para 30610

Art.	
30611	3 × 102 mm

Medium

3
PCS



Hydraulic bottle jack

Gato hidráulico de botella

Macaco de garrafa hidráulico

Art.	Cap.	Min. mm	H1 mm	H2 mm	Max. mm	 kg
3975	2 T	181	116	48	345	2.6
3976	6 T	216	127	70	413	4.5
3977	12 T	230	155	80	465	7.3
3978	20 T	242	150	60	452	11



Hydraulic trolley jack

- compact and flat design
- for a simple tyre change
- with easy to carry transport handle

Gato hidráulico

- diseño compacto y bajo
- para un fácil cambio de ruedas
- con asa para trasladar fácilmente

Macaco de rodas hidráulico

- design compacto e plano
- para uma simples mudança de pneus
- com alça para facilitar o transporte

2T

JUNIOR Line

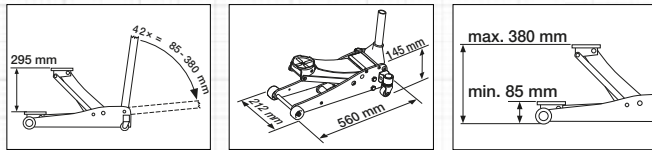

Art.	kg
38110	13

Hydraulic trolley jack

- double pump system for quick lifting
- pump lever with rubber protection
- 3 transport handles

Gato hidráulico

- sistema de doble bomba para una elevación rápida
- brazo elevador macizo con protección caucho en el mango
- 3 asas para manejar

Macaco de rodas hidráulico

- sistema de bomba dupla para elevação rápida.
- braço da bomba com protecção de borracha
- 3 pegas para transporte

2.5T

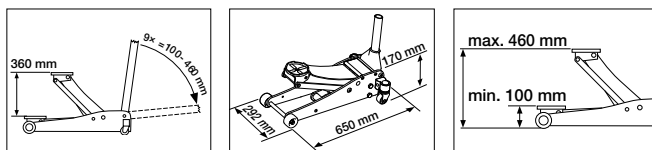

Art.	kg
3981	26



Hydraulic workshop jack

Big lifting range from min. 75 mm to max. 505 mm

Gato hidráulico

Gran capacidad de elevación desde min. 75 mm hasta 505 mm max.

Macaco rodas hidraulico 2 T

Grande capacidade de elevação, mínimo 75 mm, máximo de 505 mm

2 T

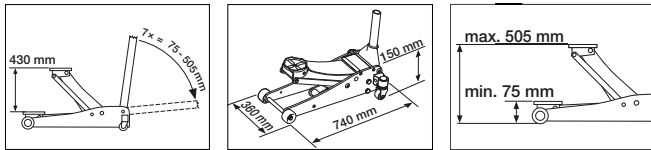

Art.	kg
38112	32.2

Hydraulic trolley jack

with quick lifting foot pedal

Gato hidráulico

con pedal de subida rápida

Macaco de rodas hidráulico

com pedal de elevação rápida

3 T



Quick lift
Elevación rápida
Elevação rápida

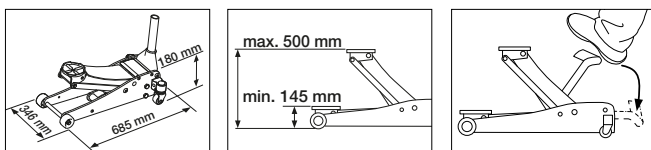

Art.	kg
38101	37.2

Low Profile frame Floor Jack

long, with rubber saddle

Gato de perfil bajo

largo, con protección caucho

Macaco de Rodas Baixo perfil

Chassis longo com selim de borracha

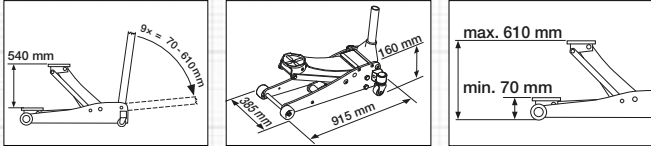

Art.	kg
38111	44.5

Hydraulic trolley jack

- flat design, works with low ground clearance
- extra long frame with 6 wheels
- quick lifting foot pedal

Gato hidráulico

- diseño bajo para utilizar en espacios mínimos
- estructura extralarga con 6 ruedas
- con pedal de subida rápida

Macaco de rodas hidráulico

- de baixo perfil
- chassis longo com 6 rodas
- pedal de elevação rápida

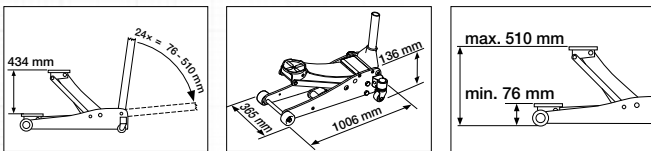

Art.	kg
38102	42

Hydraulic trolley jack

- robust design
- quick lifting foot pedal

Gato hidráulico

- diseño robusto
- con pedal de subida rápida

Macaco de rodas hidráulico

- robusto
- pedal de elevação rápida

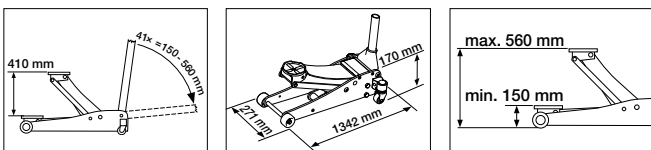

Art.	kg
38105	87

1.5T



2T



5T



Foldable jack stands, pair
Pareja de caballetes plegables
Par de preguiças dobrável

Art.	Min. mm	Max. mm	kg
3972	276	363	3

2T



Jack stands, pair
Pareja de caballetes
Par de preguiças

Art.	Min. mm	Max. mm	kg
3979	280	420	7

3T



Jack stands, pair
Pareja de caballetes
Par de preguiças

Art.	Min. mm	Max. mm	kg
38106	382	600	14.2

6T



Universal wheel changing set

with

- 3 t trolley jack with quick lift pedal
- Pair of jack stands 3 t
- Knee and seat pad
- Cross rim wrench 17 × 19 × 22 mm × 1/2" CrV
- Multi-function LED light/blinking warn light
- Mechanic's working gloves L.

Juego universal para cambio de ruedas

con

- Gato hidráulico 3 t con pedal de elevación rápida
- Caballetes 3 t
- Almohadilla
- Llave ruedas cruz 17 × 19 × 22 mm × 1/2" CrV
- Lámpara LED multiuso/luz de aviso
- Guantes mecánico KWR, talla L.

Jogo universal de mudança de roda

com

- Macaco hidráulico de rodas com pedal de elevação rápida
- Par de preguiças 3 t
- Protectores de joelhos
- Chave de rodas em cruz 17 × 19 × 22 mm × 1/2" CrV
- Gambiarra LED multifunções/gambiarra de aviso
- Joelheiras, tamanho L.

Quick lift
Elevación rápida
Ascensão rápida



3T



470 × 200 × 30 mm

CrV



375 mm

1/2" 17-19-22 mm



3T

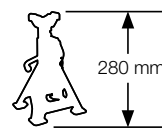
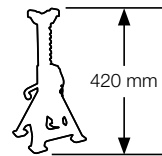

7 kg

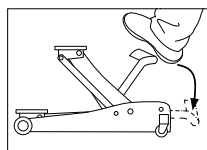
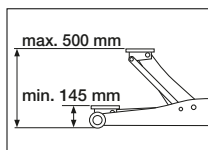
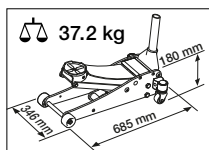

Art.

kg

38101SET

37.2 kg

Universal lifting equipment set with

- 1.5 t Low profile frame floor Jack
- Pair of jack stands 3 t 280-420 mm
- Knee and seat pad
- Cross rim wrench 17 x 19 x 22 mm x 1/2" CrV
- Rechargeable cordless 2 x 1W high power LED lamp
- Mechanic's working gloves L

Juego universal para cambio de ruedas con

- Gato hidráulico 1,5 t con perfil bajo
- Caballetes 3 t
- Almohadilla
- Llave ruedas cruz 17 x 19 x 22 mm x 1/2" CrV
- Lámpara LED 2 x 1W
- Guantes de mecánico, talla L

Jogo universal de mudança de roda com

- Macaco hidráulico de rodas de baixo perfil
- Par de preguiças 3 Ton
- Protectores de joelhos
- Chave de rodas em cruz 17 x 19 x 22 mm x 1/2" CrV
- Gambiarra LED 2 x 1 W
- Luvas de mecânico KWR L

1.5T



3T

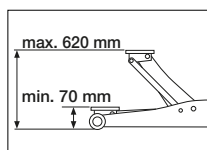
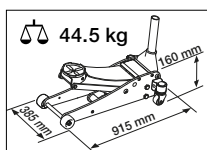
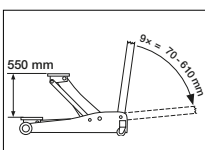
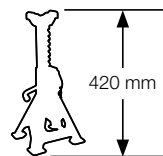

Art.	kg
38111SET	44.5 kg

Knee- and seat pad

- made of high density, water resistant PE-foam, 3 layers
- millimeter and angle pitch line

Almohadilla

- 3 estratos de espuma de polietileno de alta densidad, resistente al agua
- regla impresa en mm y líneas de graduación de ángulo

Protector de joelhos e outros

- fabricado em espuma PE de grande densidade, resistente a água, 3 camadas
- impresso com escala e ângulos



470 × 200 × 30 mm

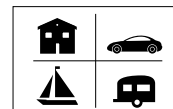

Art.

38001

ABS-plastic Workshop creeper

- solid and compact ABS-plastic design with transport handle
- extra deep and ergonomic shaped, adapted arm sections
- padded headrest
- tools and small parts compartment on both sides
- 6 easy turning rubber swivel rollers

Camilla de taller en ABS

- mono-bloc en ABS, sólida, compacta, resistente, con asa para transportar
- ergonomía máxima para el cuerpo y la colocación de los brazos
- reposacabezas acolchado
- compartimentos para útiles y pequeña herramienta en los dos lados
- 6 ruedas pivotantes en caucho

Estrado de mecânico

- sólido, compacto e indestrutível ABS plástico equipado com pega de transporte
- forma ergonómica especial para o corpo, secções ajustáveis para os braços
- encosto de cabeça almofadado
- compartimentos para ferramentas e peças pequenas em ambos os lados
- 6 rodízios giratórios em borracha.

max. 120 kg ABS



Art.

3991

1010 × 480 × 115 mm

De Luxe creeper

with 6 swivel wheels. Thick and comfortable foam rubber cushion.

Camilla de Luxe

con 6 ruedas pivotantes. Fina, comfortable, acolchado con espuma gruesa.

Esteira deluxo

com 6 rodas giratórias. Acolchoamento espesso e confortável de espuma emborrachada.

max. 180 kg



1135 × 510 × 185 mm

Art.

3988

Foldable creeper and work seat
Camilla y asiento de taller
Estrado de mecânico e banco



↕ 540 × 455 × 500 mm

2 in 1

Max.
150
kg



↕ 1020 × 455 × 150 mm



Art.

3989

Rolling work seat

- with 5 swivel wheels
- comfortable seat-cushion
- base with tool-compartment

Taburete de trabajo

- con 5 ruedas pivotantes
- asiento cómodo
- compartimento para herramientas

Assento de trabalho rotativo

- com 5 rodas giratórias
- almofada confortável
- compartimento para ferramenta

Max.
135
kg



max.
570 mm min.
450 mm



↕ 450 - 570 mm, Ø 450 mm

without tools
sin herramientas
sem ferramentas

Art.

3984

Cross rim wrench
Llave ruedas cruz
Chave de rodas em cruz

CrV

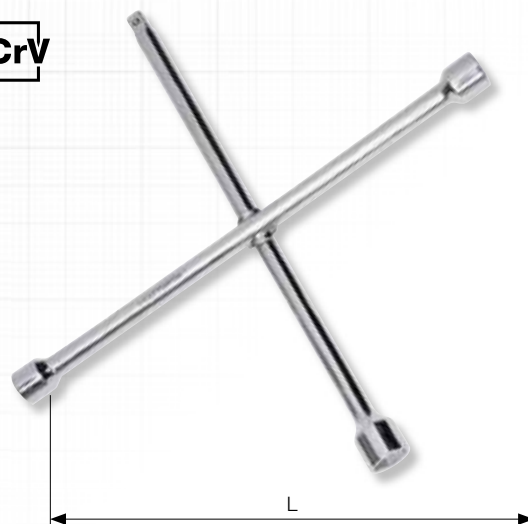

Art.	mm		L mm
2585-12	17-19-22	1/2"	375
2585-34	24-27-32	3/4"	625

L type wheel wrench with double socket
extensible

Llave ruedas en L con llave de vaso doble
extensible

Chave de rodas tipo L com chave dupla
extensível

Art.	mm	L1 mm	L2 mm
2585-1719	17 x 19	365	525
2585-1721	17 x 19 21 x 22	365	525

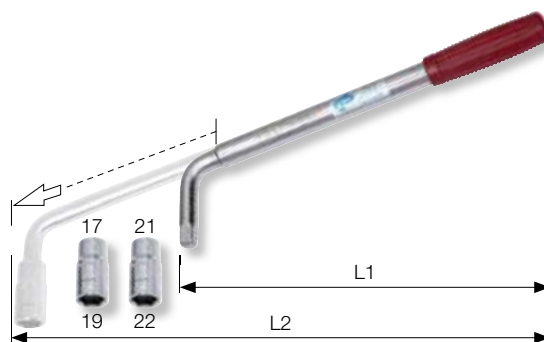

Torque multiplier set
with 7 chrome-molybdene impact sockets

Juego de multiplicador de par
con 7 vasos de impacto en cromo-molibdeno

Jogo de multiplicador de torque
com 7 chaves de impacto em cromo-molibdênio

1" 1" 1" 1 PCS

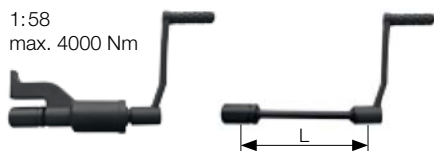

1"	7	24-27-30-32-33-36-38 mm	78 mm
3/4"			75 mm

Art.	L mm
30213	270



405 x 310 x 95 mm

Torque wrenches refer to chapter 8
Llaves dinámicas ver capítulo 8
Chaves dinâmicas ver capítulo 8



Pneumatic impact wrench

specialy short and light weight design with aluminium housing, heavy duty twin hammer gear for strong max. torque of 744 Nm - 3 steps.

Pistola neumática de impacto

Modelo corto y ligero con carcasa de aluminio, martillos gemelos de gran capacidad, max. 744 Nm ajustable en 3 posiciones.

Chave de impacto pneumática

Curta, compacta e leve com corpo de alumínio. Sistema de martelo duplo para um torque máx. 744 Nm – 3 posições de ajuste.



Alu

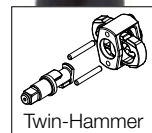

					>3.6 m/s² icon"/>	
1/2"	744	140-680	9000	1200	>3.6	90
1.6	125	1/4"	10	164	10	6.2-7
Art.						
3834						

Air tool case

with impact wrench 1/2" 3834 and ratchet wrench 1/2" with socket quick release function. Including the 5 most used sockets, extension bar and universal joint adapter.

Conjunto neumática

con pistola 1/2" 3834 y carraca 1/2" con extracción rápida. Incluye 5 vasos más utilizados, alargadera y adaptador universal.

Conjunto pneumático

de chave 1/2" 3834 e roquete de impacto 1/2" com função de ejeção rápida das chaves. Incluindo as 5 chaves de impacto mais usadas, extensão e cardan.

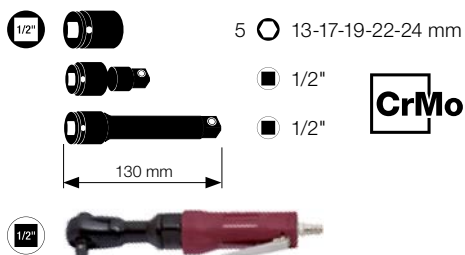

CrMo

				<4 m/s² icon"/>		
1/2"	68	14-60	160	<4	90	260
1.22	1/4"	10	BSP	164	10	6.3
Art.						
31015						

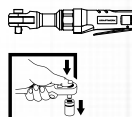

375 x 270 x 80 mm

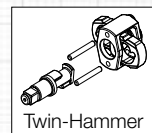

Industrial impact wrench

with impact proof composite housing. Super twin hammer gear with extreme torque 1486 Nm, 3 steps, one-handed operation for left- and right hander.

Pistola neumática industrial de impacto

estructura resistente a golpes, en composite. Martillos gemelos para máximo 1486 Nm, ajustable 3 grados, utilizable con una sola mano por diestro y zurdo.

Chave de impacto pneumática industrial

fabricada em compósito resistente ao choque engrenagem de martelo gêmeo e um torque extremo de 1486 Nm, ajustável em 3 estágios, para uso com uma mão direita e para canhotos.

1/2"	max.1486	68-810	8000	1250	>2.5	89
1.9	170	1/4"	10	142	10	6.2-7
Art.						
3837						



Universal impact wrench tool case

with industrial impact wrench 1/2" dr. 3837, 20 impact sockets in CrMo, 2 extension bars and socket-adaptor 3/4" dr. In plastic case fitting the HIGHTECH tool-cabinets.

Estuche universal de herramientas neumáticas de impacto

con pistola neumática industrial de impacto 1/2" 3837, 20 vasos de impacto en CrMo, 2 alargaderas y adaptador para vaso 3/4". En maleta plástica adecuada para los carros HIGHTECH.

Conjunto universal ferramentas pneumáticas impacto

com chave de impacto industrial de 1/2" 3837, 20 chaves caixa de impacto en CrMo, 2 extensões e adaptador para chaves caixa 3/4". Vem numa mala de plástico adequada para carros HIGHTECH.

		12	10-11-13-14-15-17-19 21-22-23-24-27 mm
		3	23-24-27 mm
		5	15-17-19-21-22 mm
			125 mm
			65 mm

Art.	
3837K	



410 x 270 x 90 mm

Cordless impact wrench 18V, 1/2"

- 850 Nm breakaway torque
- special compact and well balanced lightweight body
- 0-2'000 rpm / 0-3'000 ipm for faster speed application
- with 6 step digital torque control

Llave de impacto a batería, 1/2" 18 V

- 850 Nm par de apriete
- cuerpo compacto, ligero y bien equilibrado
- 0-2'000 rpm / 0-3'000 rpm para aplicaciones de gran velocidad
- ajuste de 6 posiciones de par en pantalla digital

Chave de impacto a bateria, 1/2" 18 V

- 850 Nm de aperto
- corpo compacto, ligeiro, bem equilibrado
- 0-2000 rpm / 0-3000 rpm para aplicações de grande velocidade
- com 6 níveis de controlo de aperto (torque) digital

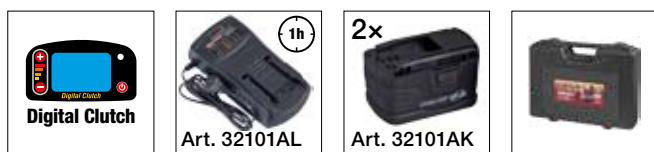

Breakaway torque	Reverse torque	Tightening torque	Digital Clutch 5+ Max.	1 min.	kg
1/2"	850	640	400	80-260	0-2000 0-3000 1.93

Art.	
32103	Impact wrench/Llave de impacto/Chave de impacto



410 × 296 × 100 mm

18V Li-Ion 4000 mAh

Cordless high power impact wrench 18V, 1/2"

- 1500 Nm breakaway torque
- well balanced, solid body
- 0-1'700 rpm / 0-2'000 ipm for fast and powerful application
- with 6 step digital torque control

Llave de impacto a batería, 1/2" 18 V

- 1500 Nm par de apriete
- cuerpo sólido y bien equilibrado
- 0-1'700 rpm / 0-2'000 rpm para aplicaciones rápidas y potentes
- ajuste de 6 posiciones de par en pantalla digital

Chave de impacto a bateria, 1/2" 18 V

- 1500 Nm de aperto
- corpo sólido, bem equilibrado
- 0-1700 rpm / 0-2000 rpm para aplicações rápidas e potentes
- com 6 níveis de controlo de aperto (torque) digital

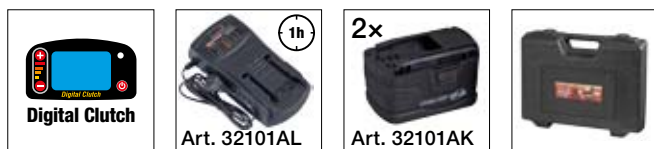

Breakaway torque	Reverse torque	Tightening torque	Digital Clutch 5+ Max.	1 min.	kg
1/2"	1500	1060	680	80-300	0-1700 0-2000 3.26

Art.	
32104	Impact wrench/Llave de impacto/Chave de impacto



450 × 331 × 127 mm

18V Li-Ion 4000 mAh

Impact socket wrench set
Juego de llaves de vaso impacto
Jogo de chaves impacto

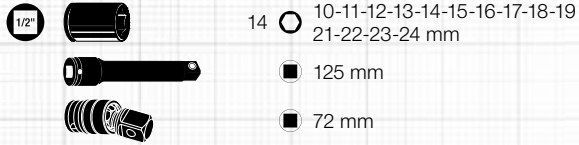

Art.
380005

Deep impact socket wrench set
Juego de llaves de vaso largas impacto
Jogo chaves de caixa longa impacto

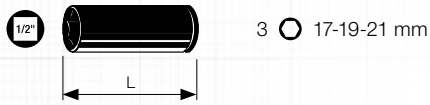

Art.	L mm
381099	85

Deep impact socket wrench set
with plastic insert to protect the wheel nuts and plastic sleeve for aluminium rims

Juego de llaves de vaso largas impacto con inserto plástico para proteger las tuercas de rueda y manga plástica para llantas en aluminio

Jogo de chaves impacto
com protecção plástica para proteger as porcas das rodas e manga plástica para as jantes de alumínio

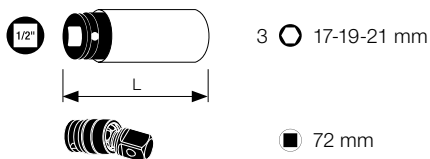

Art.	L mm
3083	85



270 × 185 × 58 mm

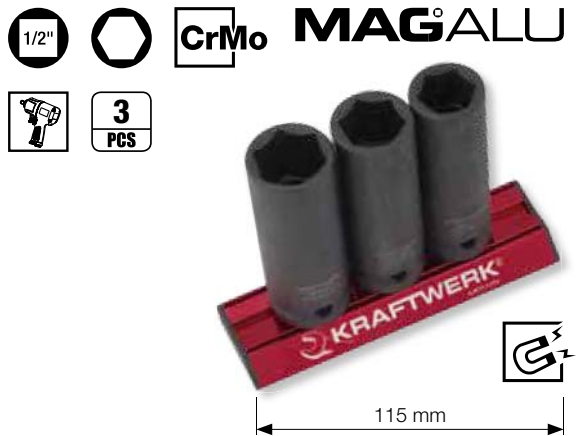

Deep impact socket wrench set

with plastic insert to protect the wheel nuts and plastic sleeve for aluminium rims

Juego de llaves de vaso largas impacto
con inserto plástico para proteger las tuercas de rueda
y manga plástica para llantas en aluminio

Jogo de chaves impacto

com protecção plástica para proteger as porcas das
rodas e manga plástica para as jantes de alumínio

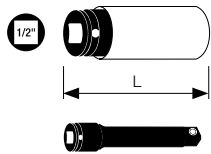

6 15-17-19-21-22-24 mm

125 mm

Art.	L mm
381005	85



± 212 × 151 × 48 mm

Universal impact socket set

in COMPLETO carrying case

Juego universal de llaves de vaso impacto
en estuche COMPLETO

Jogo universal de chaves impacto
em mala COMPLETO



COMPLETO



8-9-10-11-12-13-14-15-16
17-18-19-21-22-24 mm

14-17-19-21-22-24 mm

17-19-21-22-24 mm

1/2" 1/2" L: 125 mm

1/2" 3/4" L: 48 mm

1/2" 1/2" L: 65 mm

Art.	
4900-70K	1/2"
4900-70B	without case / sin maletín / sem caixa



± 421 × 200 × 68 mm

Industrial pneumatic impact wrench















with impact proof composite housing and reinforced aluminium hammer case. Refined twin hammer impact mechanism with extreme torque max. 1'830 Nm, 4 steps adjustable.

Pistola neumática industrial de impacto

con estructura resistente a golpes y carcasa compuesta de aluminio reforzado. Engranaje de martillos gemelos con grado de fuerza máxima de 1'830 Nm, ajustable en 4 etapas.

Chave de impacto pneumática industrial

fabricada em compósito resistente ao choque com corpo de alumínio reforçado, engrenagem de martelo gémeo e um torque extremo de 1'830 Nm, ajustável em 4 estágios.

						
3/4"	max.1830	271-1220	6500	1150	<15.04	96.12
						
3.4	215	3/8"	12.5	241	10	6.2
Art.				□		
3838				3/4"		



Impact socket wrench set

Juego de llaves de vaso impacto

Jogo de chaves impacto

  8  26-27-29-30-32-35-36-38 mm

Art.	
400005	

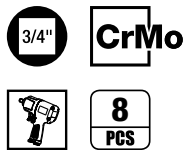

± 270 × 185 × 58 mm

Deep impact socket wrench set

Juego de llaves de vaso largas impacto

Jogo chaves de caixa longa impacto

  8  26-27-29-30-32-35-36-38 mm

Art.	
400015	

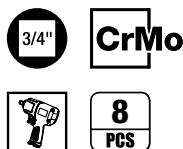

± 270 × 185 × 58 mm

Impact socket wrench set
Juego de llaves de vaso impacto
Jogo de chaves impacto

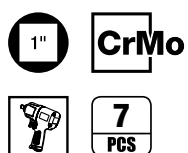

7 ○ 24-27-30-32-33-36-38 mm

Art.

500015

± 270 × 185 × 58 mm



Wobble impact adapter set

Juego de adaptadores/reductores articuladas de impacto

Jogo de adaptadores/redutores de impacto

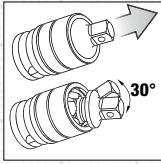

Art.	□	■	L mm
387999	1/4"	3/8"	36
	3/8"	1/4"	44
	3/8"	1/2"	48
	1/2"	3/8"	57
	1/2"	3/4"	70

Impact socket adapter set

with locking function

Juego adaptadores de impacto para vasos

con bloqueo

Jogo de adaptadores de impacto

com fecho automático

Art.	●	■	L mm
381014	1/4"	1/4"	75
381038	1/4"	3/8"	75
381012	1/4"	1/2"	75
381003	1/4"	Set / Juego / Jogo 1/4" + 3/8" + 1/2"	75

Impact socket adapter set

with locking function

Juego adaptadores de impacto para vasos

con bloqueo

Jogo de adaptadores de impacto

com fecho automático

Art.	●	■	L mm
381114	1/4"	1/4"	150
381138	1/4"	3/8"	150
381112	1/4"	1/2"	150
381103	1/4"	Set / Juego / Jogo 1/4" + 3/8" + 1/2"	150

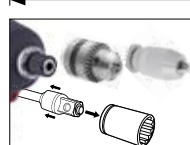
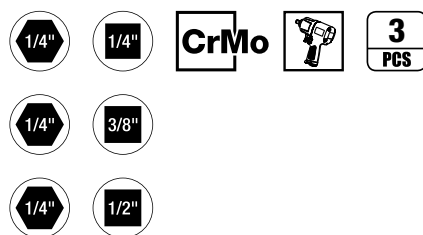
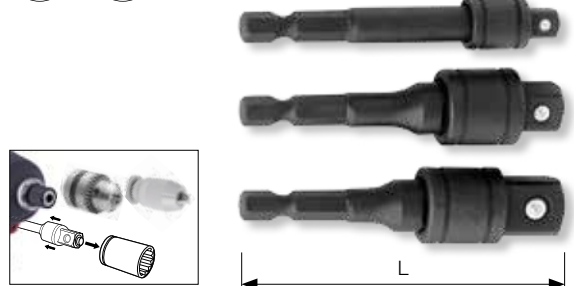
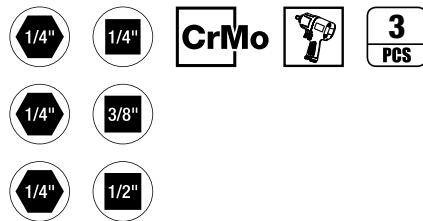
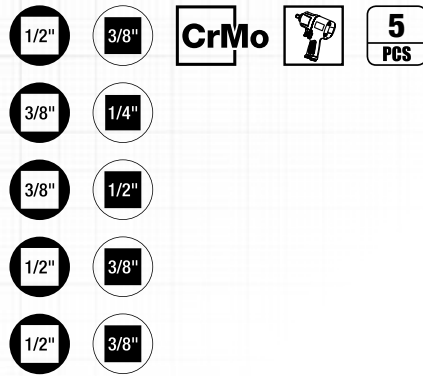

COMPLETO

Tire pressure sensor tool case

suitable for TPMS, for removing and mounting tire pressure control systems. Optimal composition for all models.

Estuche útil para válvulas con sensor de presión de neumáticos

adecuado para TPMS, para extraer y montar los sistemas de control de presión de neumáticos. Composición óptima para todos los modelos.

Gaveta para ferramenta de sensores de pressão de pneus

compatível com TPMS, para remoção e montagem de sistemas de controlo da pressão dos pneus. Composição otimizada para todos os modelos.



2 11-12 mm

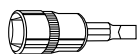

3 T10-T15-T20
4.5 mm



50 mm

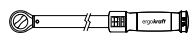

Art. 3231

2.5-12 Nm / 20-105 Lb.in



1/4" 1/4"



140 mm

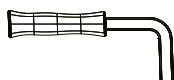

1/4" 100 mm



1/4"



1/4" 4 mm 0 Lb.in 150 mm
0.5-3.5 Nm / 4.5-30 Lb.in 150 mm



2 0.25-0.45 Nm / 2.2-4 Lb.in 120 mm



2 mm



421 x 200 x 68 mm

Art.

4900-74K

4900-74B

without case / sin maletín / sem caixa

Analogue tyre inflator

with big display for bar and psi. Well protected grace to the strong case.

3 in 1 function: measuring, inflate and deflate.

(Not available in France)

Manómetro/inflador analógico

con reloj para bares y psi. Manómetro con diámetro de 80 mm y protección antigolpes.

3 funciones en 1: medir la presión, inflar y desinflar.

Pesa ar analógico

com manómetro de grandes dimensões para bar e psi.

Bem protegido devido a forte protecção exterior.

Função 3 em 1: medir, encher e retirar ar.

(Indisponível in França)

bar / psi / kpa / kgf



Art.

max. bar

L mm

31003

0-12 bar
0-174 psi

210

EN 12645:1998 (86/217/EEC)

Digital tyre inflator

with background lighting for bar, psi, kpa and kgf. Well protected grace to the strong case.

3 in 1 function: measuring, inflate and deflate.

Measuring tolerance: +/- 1 %.

(Not available in France.)

Manómetro /inflador digital

con pantalla luminosa para bares, psi, kpa y kgf.

Protección antigolpes.

3 funciones en 1: medir de la presión, inflar y desinflar.

Precisión de medición : +/- 1 %

Pesa ar digital

com contraluz para bar, psi, kpa e kgf. Bem protegido devido a forte protecção exterior.

Função 3 em 1: medir, encher e retirar ar.

Precisão da medição: +/- 1 %

(Indisponível in França.)



Art.	max. bar	L mm
31004	0-12 bar 0-174 psi	210

bar / psi / kpa / kgf



EN 12645:1998 (86/217/EEC)

Tyre gauge, 3 in 1

1. Digital tyre pressure gauge

2. Digital tyre depth gauge

3. LED light

Display with background lighting. Different modes for bar, psi or kgf

Medidor 3 en 1

1. Medidor digital para presión de neumáticos.

2. Medidor grosor dibujo neumático.

3. LED

Pantalla luminosa. Diferentes modos de medición bar, psi o kgf

Medidor pneus 3 em 1

1. Medidor digital de pressão

2. Medidor digital de profundidade

3. Luz LED

Mostrador com contraluz. Diferentes medidas bar, psi ou kgf



Art.	max. bar
31006	0-14 bar



100 × 55 × 20 mm

Car emergency tool and digital tyre gauge
*Herramienta de emergencia para coches
y medidor digital de presión para neumáticos*
Ferramenta de emergência para carros
e verificador digital de pressão de pneus



Art.

31008

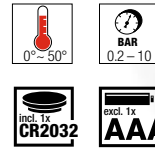

BLACKLINE

bar / psi / kpa



↕ 160 x 70 x 25 mm

Balancing wheel pliers
Alicate equilibrar ruedas
Alicate para pesos de rodas

Art.	L mm
4256-240	240



HIGHTECH

Made in Germany



Bag for wheel screws

Bolsas para tornillos de ruedas

Sacos para parafuso de rodas



Art.	
30217	50



± 140 x 200 mm

Tyre bags

Sacos para neumáticos

Sacos para pneus

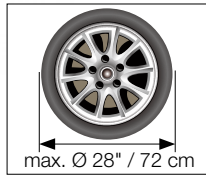
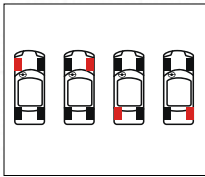

Art.
30221

4
PCS

JUNIOR Line



Tyre chalks

Tizas para marcar neumáticos

Gizes para marcar pneus

Art.
30222

water-resistant

12
PCS

JUNIOR Line



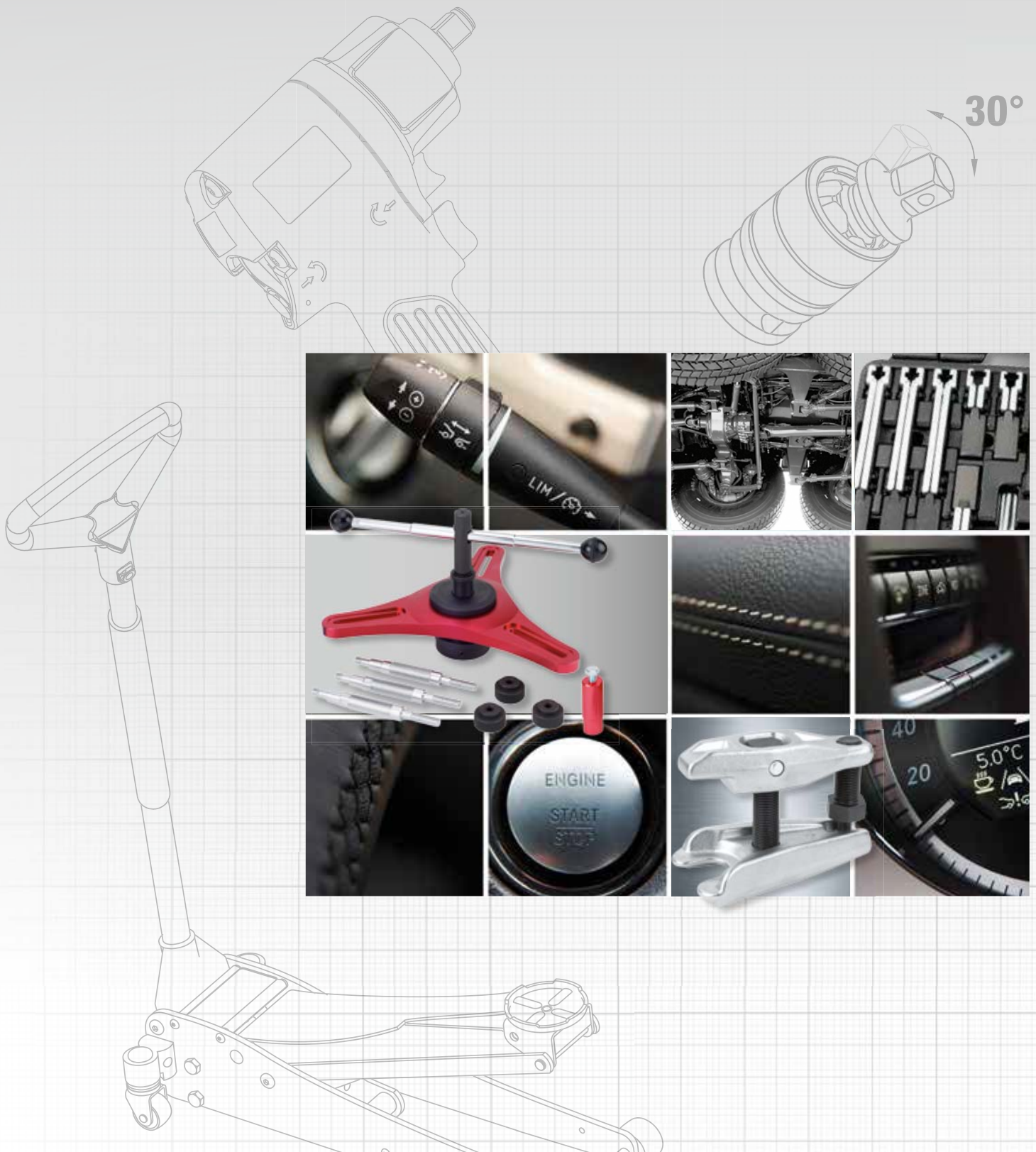

2

Gear, steering and suspension
Transmisión, dirección y suspensión
Transmissão, direção e suspensão

Hydraulic spindle- and wheel hub

- universal use for nearly all cars with 4- and 5-hole hub due to different distances between the holes
- high power efficiency by hydraulic use
- Hydraulic capacity 12 tons

Extractor hidráulico de cubos de ruedas

- uso universal para la mayoría de 4 y 5 agujeros de fijación
- gran eficiencia por uso hidráulico
- capacidad hidráulica 12 toneladas

Extractor de cubos hidráulico

- universal para a maioria dos carros, de 4 e 5 furos
- grande poder de eficiência para uso hidráulico
- capacidade hidráulica 12 toneladas

12T

116 - 135 mm



Art.	
30214	Audi, Citroën, Fiat, Opel, Peugeot, Renault, Seat, Škoda, Volvo, VW, etc.

Universal crank bearings puller tool set

for removing bearings, interior rings and other tightly fixed parts

Juego extractores de guillotina

para la extracción de los rodamientos, anillos internos y otras partes montadas de forma firme y ajustada

Conjunto sacas meia-lua

para remover rolamentos, interiores, e outras partes firmemente fixas e ajustadas



Art.	Ø mm
30401	30-50 50-70

↕ 275 × 205 × 55 mm

Universal puller set

2 and 3-arms, can be used as inner and outer puller.
 Exchangeable, hardened puller feet.

Juego universal de extractores

de 2 y 3 garras, permite operaciones de extracción internas y externas. Garras endurecidas e intercambiables.

Conjunto sacas universal

de 2 e 3 pernas, permite extrações internas e externas.
 Pernas do extractor endurecidas e intercambiáveis.

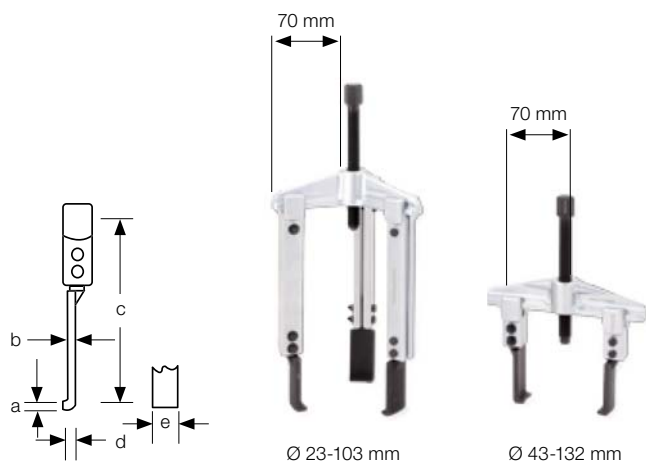

Art.	a	b	c	d	e
30402	3.6 mm	6 mm	100 mm	13 mm	27 mm
	3.6 mm	6 mm	200 mm	13 mm	27 mm
	3.6 mm	6 mm	250 mm	13 mm	27 mm

12
 PCS



420 x 375 x 66 mm

Self adjusting clutch assemble tool

for proper removal and reinstallation as well as centering of self-adjusting 3-hole clutches

Autocentrador para embragues SAC

para desmontar y montar rápidamente embragues SAC con 3 agujeros

Conjunto aparelho de centrar embraiagem auto ajustável SAC

para remover e instalar as embraiagem auto ajustáveis com três pontos fixação



Art.



30403

Audi, BMW, Mercedes, Opel (Vauxhall), Renault

Ball joint puller

2-step adjustable, for pressing out the ball joints when removing ball joints from the stabiliser, steering knuckle, steering lever etc.

Extractor de rótulas

ajustable en 2 pasos, para extraer las articulaciones esféricas del estabilizador, rótula de dirección, palanca de dirección, etc

Extractor de rótulas

ajustável em 2 passos, para a extração das juntas esféricas do estabilizador, da rótula direção, braço de direção, etc.

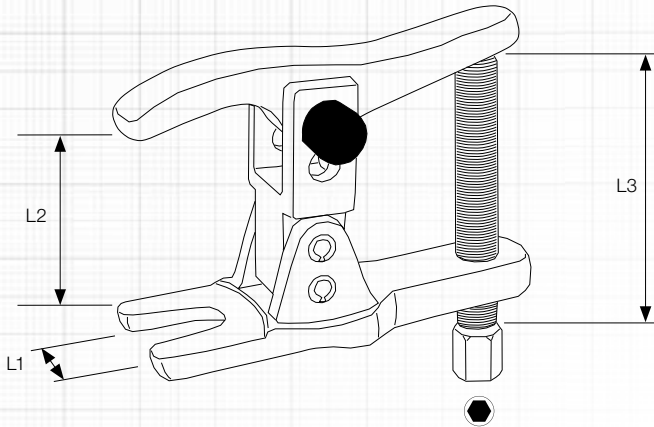

Art.	L1 mm	L2 mm	L3 mm	● mm
30404	22	40-110	130	17

CrMo



Universal ball joint puller

for pressing out the ball joints

Extractor universal de rótulas

para la extracción de las articulaciones esféricas en suspensiones

Extractor de rótulas universal

para a extração das rótulas esféricas

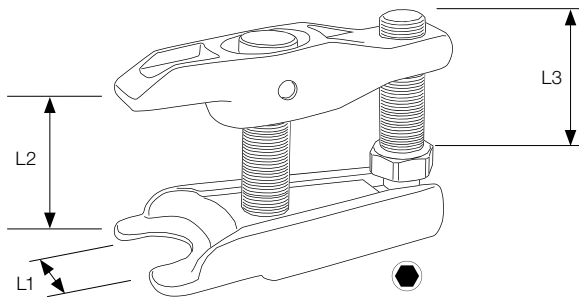

Art.	L1 mm	L2 mm	L3 mm	● mm
30405-20	20	50	54	19
30405-32	32	80	90	29

CrMo



Tie-rod/ball-joint splitter set

with three different fork sizes, adapter for impact and pneumatic chisel hammer

Saca rótulas de palanca

con tres tamaños diferentes, adaptador de palanca y adaptador para martillo neumático

Saca rótulas de pancada

com três tamanhos diferentes, adaptador de pancada e adaptador para martelo pneumático

5
PCS



293 x 193 x 50 mm

Art.	
30417	L = 17 mm (11/16") L = 24 mm (15/16") L = 28 mm (1-1/8")

Coil spring compressor set

universal, for fitting and removing screw springs

Juego de compresores de muelles de amortiguadores

universal, para montaje/desmontaje de muelles de suspensión

Jogo de compressores de molas

universal, para a montagem e desmontagem das molas de suspensão

CrMo



Art.	L mm
30406	270
30407	370

Universal coil spring compressor set

with telescope tube and safety bar

Juego de compresores de muelles de amortiguadores

con eje telescópico y barra de seguridad

Jogo de compressores de molas

com tubo telescópico e barra de segurança

 Max. 200 kg

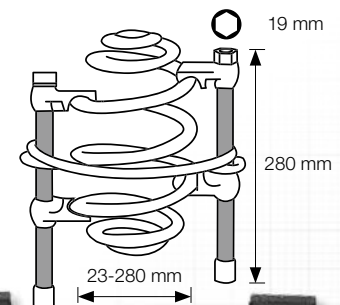

465 x 115 x 58 mm

Art.
30408

MacPherson type strut coil spring compressor kit

Exchangeable clamping plates, plastic-coated jaws protect the springs against damage of the anti-rust coating

Juego de compresores de resorte para las suspensiones MacPherson

Placas de sujeción intercambiables, copelas recubiertas de teflón protegen contra el daño de los muelles del recubrimiento anti-corrosión

Jogo de compressores de molas sistema MacPherson

Placas de fixação intercambiáveis, mandíbulas revestidas de plástico para proteger as molas contra os danos da camada anti-ferrugem

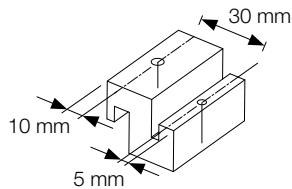
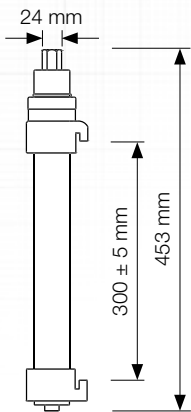
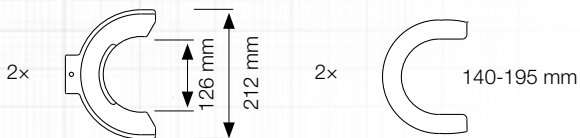
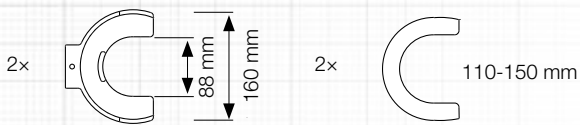

Art.	
30409	Audi, BMW, Ford, Honda, Mitsubishi, Nissan, Porsche, Saab, Subaru, Toyota, Volvo, VW

✚ 530 × 440 × 125 mm

Inner tie rod tool set

for fast and professional changing of the axial joints of cars and light commercial vehicles with automatic clamping of the joint heads.

Saca rótulas axiales

para extraer rápido y profesionalmente las rótulas de los automóviles ligeros y comerciales con colocación automática de las cabezas.

Saca rótulas axiais

para uma troca rápida e profissional das rótulas de automóveis ligeiros e comerciais com colocação automática das cabeças.

Art.	Ø mm	L mm
30215	30-35, 35-40, 40-45	360

1/2"

4
PCS



436 × 245 × 100 mm

Wishbone lever wrench

Faciliates to lift wishbone supporting joints out of the wheel bearing housing. Also very helpful to fit pre-tensioned wishbones. Support adjustable in 3 positions. Neoprene handle.

Palanca para suspensión

Facilita la extracción del brazo de suspensión y desmontaje de rótulas. Muy útil para el trabajo de un solo operario. Ajustable en 3 posiciones. Mango neopreno.

Alavanca de suspensão

Facilita a extração da suspensão articulada dos braços provenientes da caixa de rolamentos da roda. Muito útil durante a montagem dos braços em tensão. Suporte ajustável em 3 posições. Punho em neopreno.



Art.	L mm
30416	950 - 1180



Shock absorber tension tool set
Juego herramientas para suspensión
Jogo de ferramentas para suspensão

39
PCS



↕ 575 × 405 × 72 mm

Art.

30412



Info
KRAFTWERKtools.com/info/30412

Hydraulic pull and press sleeve kit
 for assembly and disassembly of all kind of bearings and bushings, with hydraulic pull and press unit

Juego hidráulico de extractores de rodamientos

para montaje y desmontaje de todos tipos de rodamientos y casquillos, con unidad hidráulica para extraer y presionar

Jogo extrator de rolamentos

para montagem e desmontagem de todos os tipos de rolamentos e casquilhos, com unidade tração e prensa hidráulica

0
PCS

18.2T



↕ 900 × 503 × 157 mm

Art.

30411



Spindle Ø mm	OD × ID mm					
10	26 × 18	34 × 26	42 × 34	50 × 42	58 × 50	66 × 58
12	28 × 20	36 × 28	44 × 36	52 × 44	60 × 52	68 × 60
14	30 × 22	38 × 30	46 × 38	54 × 46	62 × 54	
16	32 × 24	40 × 32	48 × 40	56 × 48	64 × 56	

Bearing and bush driver set

for assembly of bearings, seals and rubber, particularly useful with hydraulic presses.

Juego de pastillas de compresión

para montaje de rodamientos, juntas tóricas y gomas, particularmente se utiliza con prensas hidráulicas.

Jogo de extractores de pancada

para montagem de rolamentos, vedantes e borrachas, particularmente útil com prensas hidráulicas.

Art.	Ø mm
30204A	18-65, 74



Info
KRAFTWERKtools.com/info/30204A

52
PCS



✚ 362 × 233 × 90 mm

Bearing and bush driver set

Extension kit for 30204A

Juego de pastillas de compresión

Juego de ampliación para 30204A

Jogo de extractores de pancada

Kit de extensão per 30204A

Art.	Ø mm
30204B	70-150



Info
KRAFTWERKtools.com/info/30204B

21
PCS



✚ 420 × 365 × 160 mm



3

Engine tools
Útiles automoción
Ferramenta de motor

Vacuum and pressure break testing kit

for bleeding or suction of the brake-, clutch and fuel system as well as for testing of the vacuum systems.
Delivered in case with flexible hose and various couplings.

Bomba de presión y vacío

Para alta y baja presión. Permite el purgado del sistema de frenos, del embrague y del circuito del combustible y el control de los circuitos de vacío. Suministrado en caja con tubo flexible y distintas conexiones.

Kit teste pressão e vácuo

para sangramento ou sucção de travões, embreagem e sistema de combustível bem como para o teste dos sistemas de vácuo. Entregue em mala com mangueira flexível e várias ligações.



28
PCS



✚ 335 × 310 × 90 mm



Info
KRAFTWERKtools.com/info/30201

	-1 – 4 bar -30 – 60 psi		2x 120 ml
	2x 650 mm Ø 9 mm		2x 80 mm 2x 92 mm Ø 9 mm
	1x Ø 4 mm + 6 mm 1x Ø 6 mm + 6 mm 1x Ø 8 mm + 6 mm 1x Ø 10 mm + 6 mm		14 pcs

Art.



max. bar

30201

-1 – 4 bar
-30 – 60 psi

Universal twin cam locking tool

Herramienta universal para bloqueo de arboles de levas

Ferramenta universal de bloqueio da árvore de cames

Alu

2
PCS



Art.

30651



✚ 345 × 150 × 90 mm

Universal camshaft sprocket puller
Juego extractor para poleas de cigüeñal
Saca polias universal



19 mm

Art.	● mm	Ø mm
30413	19	45-70



↕ 220 x 165 x 50 mm

Sensor and sending unit socket wrench set

for removal and installation of sensors and sending unit

- for professional and damage-free application
- phosphated
- in a robust case

Juego llaves de vaso con ventana para inyectores

para extraer e instalar sensores y inyectores

- para un uso profesional y sin daños
- fosfatado
- en maletín resistente

Jogo chaves para sensores

para a remoção e instalação de sensores

- para alicação profissional e sem danos
- fosfatado
- em uma caixa resistente

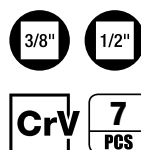

↕ 230 x 190 x 53 mm

Art.	
30639	Audi, BMW, Fiat, Ford, Mercedes, Renault, Seat, VW

Water pump pulley locking wrench

for safe blocking of water pump belt pulleys, as used per example for built-in air conditioning system.

Llave para el bloqueo de la polea de la bomba de agua

para el bloqueo de seguridad de la polea de la bomba de agua.

Chave de bloqueio para polias de bomba de água

para um bloqueio de segurança de polias da correia da bomba de água, tal como por exemplo utilizar no sistema de ar condicionado embutido.

Art.	L mm	
30631	300	Audi, VW



Belt tension adjusting tool

- especially for timing belts
- 180° pivotable handle
- can also be used in hard-to-reach areas
- extra flat design

Llave para tensar correas de distribución

- especialmente para las correas de distribución
- mango giratorio de 180°
- también se puede utilizar para zonas de difícil acceso
- tipo extra plano

Ferramenta para tensor da correia

- especialmente para correas dentadas
- punho articulável 180°
- também pode ser utilizado em áreas de difícil alcance
- design extra plano

Art.	L1 mm	L2 mm	Ø mm	
30630	195	36	20.5	Audi, VW



Valve grinder set

for grinding the valves by hand

Ventosa de esmerilar válvulas

para esmerilar válvulas

Conjunto de roda válvulas

para esmerilar as válvulas

Art.	Ø mm	L mm
30606	19 + 22	245
	22 + 32	255



Valve spring compressor

- universal application for diesel and petrol engines
- pressure pad-Ø: 25 and 30 mm

Desmontador de válvulas reversible

- aplicación universal para muchos tipos de motores
- elemento de presión -Ø: 25 y 30 mm

Grampo de válvulas

- aplicação universal para muitos tipos de motores
- pressão pad-Ø: 25 e 30 mm



Art.	L1 mm	L2 mm	L3 mm
30609	435	250	110 - 180

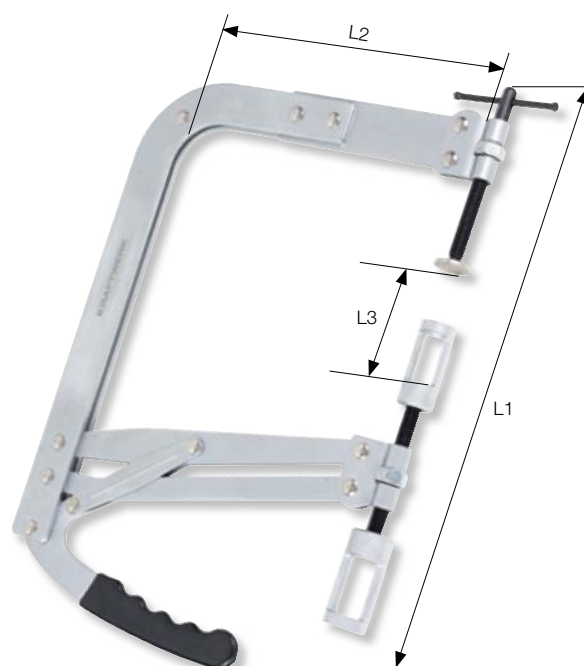

Piston ring compressor

with stepless adjustment, special spring steel

Ceñidor de segmentos de pistón

Con ajuste milimétrico, aceros especiales para resortes

Cinta de segmentos

com ajuste preciso, mola de aço especial

Art.	Ø mm	mm	L mm
30607	53-125	6	80
30608	60-175	6	100

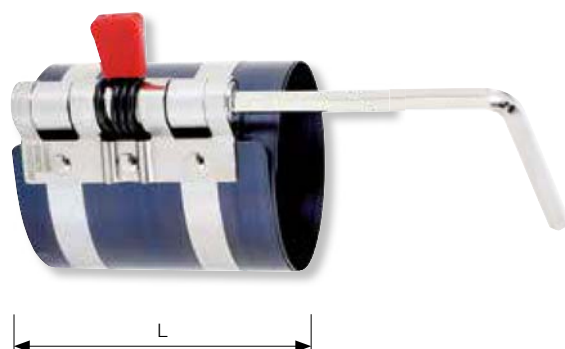

Lambda sensor socket wrench

for easy assembly and disassembly of tight lambda probes

- for difficult to reach areas
- 6- and 12-point drive side
- 180° swivel joint

Llave de vaso para desmontar sonda lambda

- para el simple montaje y desmontaje de las sondas lambda, con apertura
- para zonas de difícil acceso
- transmisión de 6- y 12-puntos
- articulación giratoria 180°

Chave para sensor lambda

- para uma simples montagem e desmontagem de sondas lambda apertadas
- para áreas de difícil acesso
- transmissão de 6 e 12 pontos
- articulação giratória de 180°

Art.	L mm	
30632	250	Audi, BMW, Citroën, Ford, Honda, Mazda, Mercedes, Mitsubishi, Nissan, Opel (Vauxhall), Peugeot, Renault, Seat, Škoda, Subaru, Toyota, VW



Special double X hose clamp pliers
Pinza doble X para tubos
Alicate Duplo X para mangueiras

Art.	Ø	L mm
30007	5/16" / 8 mm	340
30008	1/2" / 12.7 mm	335
30009	3/4" / 19 mm	335

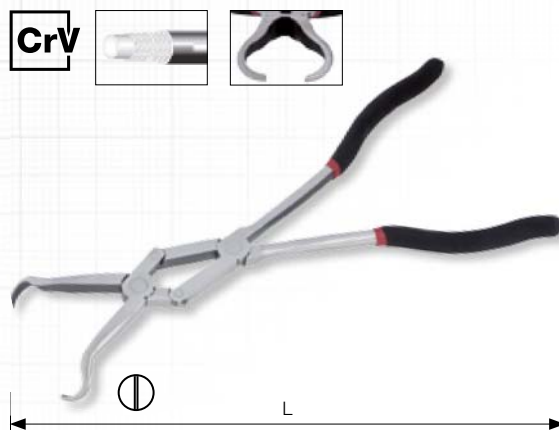

Hose clip pliers
Alicate para abrazaderas
Alicate para abraçadeiras

Art.	L mm
4251-175	175



Line clamp set
Juego alicates estrangulador
Kit de alicates para oclusão de tubos

Art.	Pos.	L1 mm	L2 mm
31123	1	153	max. 10
	2	183	max. 15
	3	250	max. 24

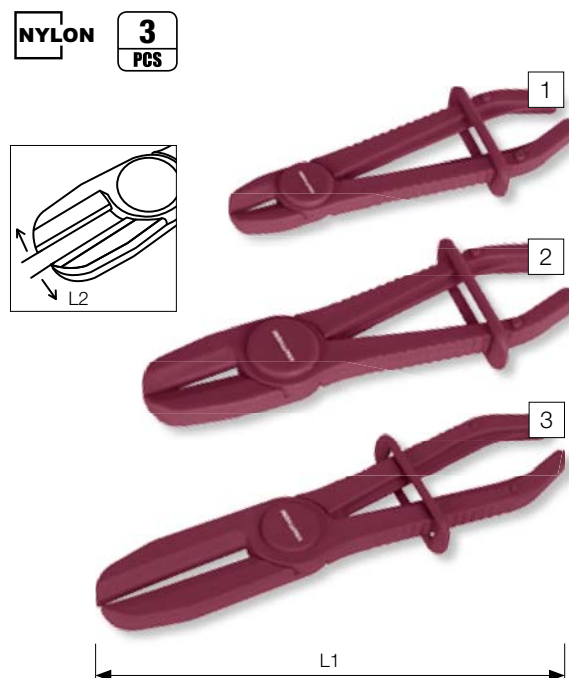

Spark plug pullers

for damage free removal of ignition coils. Prevents damage and expensive replacement of the coil.

Juego de extractores de bobinas de encendido

para el montaje y desmontaje de bobinas de encendido.

Previene daños en la bobina.

Conjunto de extractores de bobinas de ignição

para a remoção segura de velas de ignição e bobinas de ignição.

Evita danos e substituição dispendiosa da bobina.

4
PCS



↕ 285 × 160 × 50 mm

Art.	
30642	VW

Spark plug socket remover

- especially for metal-coated spark plug sockets on VW engines
- prevents spark plug wires from damage during assembly

Removedor bujías

- especial para las bujías recubiertas de metal en los motores de VW
- evita daños en los cables de las bujías durante el montaje

Chave de velas encandescentes

- especialmente para velas revestidos de metal em motores VW
- evita danos à ignição durante a montagem.



← L →

Art.	L mm
30640	230

Universal joint spark plug wrench

Llave de bujía articulada

Chave de velas articulada

Art.	Ø mm	L mm
2591-16	16	240
2591-21	21	245

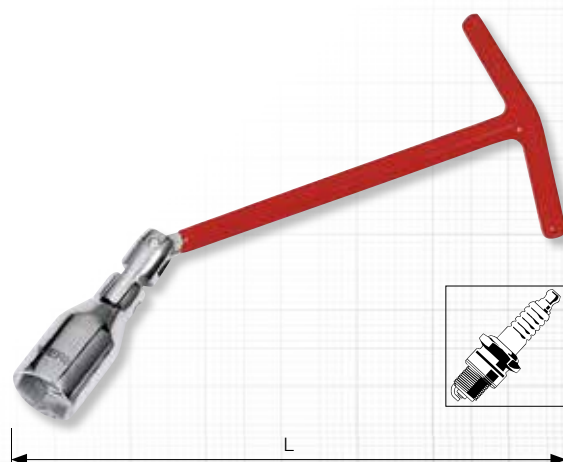

← L →

Spark plug socket wrench set

on magnetic aluminium rail

Juego de llaves de vaso para bujías

sobre regleta magnética en aluminio

Jogo de chaves de caixa de velas

em suporte magnético de alumínio

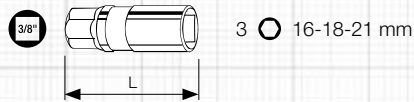

Art.	Ø	L mm
201998	3/8"	16 = 64 / 18 = 65 / 21 = 70

Spark plug socket wrench set

on magnetic aluminium rail

Juego de llaves de vaso para bujías

sobre regleta magnética en aluminio

Jogo de chaves de caixa de velas

em suporte magnético de alumínio

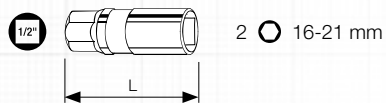

Art.	Ø	L mm
301998	1/2"	16 = 64 / 21 = 70

Spark plug thread repair tool set

Juego reparadores de roscas de bujías

Jogo para reparar roscas de velas

Art.	PCS	Ø ×  mm
30641		M16 × 1.25
30641-1	5x	M16 × 1.25 × 11.2 mm
30641-2	5x	M16 × 1.25 × 17.5 mm
30641-3	5x	M16 × 1.25 × 17.5 mm
30641-4	1x	M16 × 1.25 × 70 mm



MAG^oALU

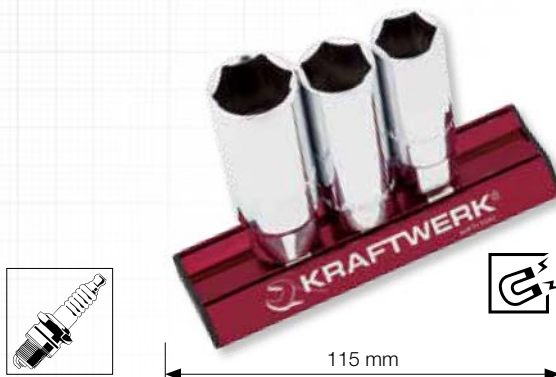

MAG^oALU





Diesel injector socket wrench kit
Juego llaves de vaso para inyectores
Jogo de chaves de inyectores diesel

1/2" CrMo 6 PCS

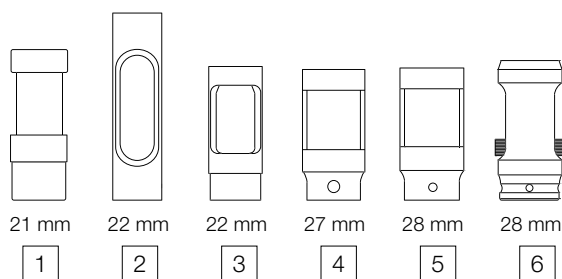

275 x 160 x 57 mm



Art.	Pos.	
30636	1	Ford Duratorq
	2	Audi, BMW, GM, Mercedes, Rover, Seat, Volvo, VW
	3	Nissan, VW
	4	BMW, Fiat, Ford (Peugeot)
	5	HGV, Scania, Volvo
	6	Alfa Romeo 2.5D - VM engines Chrysler Voyager/Cherokee - 2.5D VM engines Land Rover 2.4D - VM engines Rover 2.5D - VM engines

Diesel injector puller
Extractor inyectores diesel
Saca inyectores diesel

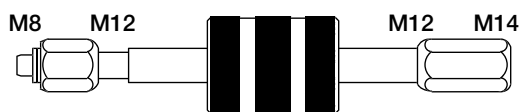

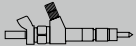
Art.	Ø	
30637	M8 / M12 / M14	Bosch, Lucas



300 x 90 x 66 mm

Diesel injector seat cutter assortment

- easy to use
- for damage-free and professional application
- in durable plastic storage case

Conjunto para limpieza de toberas inyectoras diesel

- fácil de usar
- una aplicación profesional para prevenir daños
- en estuche de plástico resistente

Kit rectificador de inyectores

- fácil de usar
- para uma aplicação profissional e sem danos
- em caixa de armazenamento de plástico durável

7
PCS

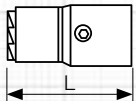

15 mm x 19 mm
Universal

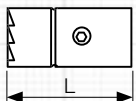

17 mm x 17 mm
Delphi / Bosch
(BMW / PSA-Renault / Ford)

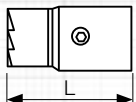

17 mm x 19 mm
Bosch (Mercedes CDI)

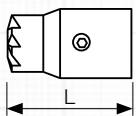

17 mm x 21 mm
Fiat / Iveco

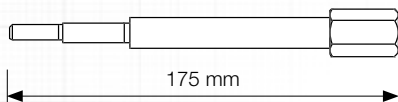

175 mm

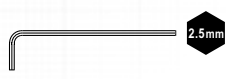

2.5mm

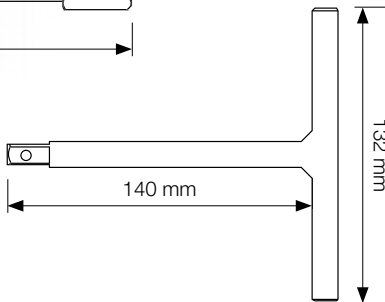

140 mm

132 mm

Art.	L mm
30638	39

↕ 275 x 160 x 60 mm

Glow plug connector pliers, straight
Alicates para calentadores, recto
 Alicate para velas direito



Art.	L mm
30634	240



Glow plug connector pliers, angled
Alicates para calentadores, curvado
 Alicate para velas angular



Art.	L mm
30635	255



Oil filter strap wrench
Filtro de aceite llave de correa
 Chave para filtro de óleo com cinta

Art.	Ø mm	L mm	L inch
30654	0 - 240	230	9



Heavy duty oil filter chain wrench

- heavy duty tool with duplex chain
- claw prevents slipping
- 180° swivel handle
- easy to use due to special chain-lock

Llave de filtro de cadena

- herramienta gran potencia de doble cadena
- garra para evitar el deslizamiento
- mango giratorio 180°
- fácil de usar debido al bloqueo especial de la cadena

Chave de filtros de corrente para trabalhos pesados

- ferramenta de serviço pesado com corrente dupla
- previne a garra de deslizar
- articulação giratória de 180°
- fácil de usar devido à corrente de bloqueio especial



Art.	Ø mm	L1 mm	L2 mm
30613	60-105	230	22

Self gripping oil filter spiral wrench

3-arms

Llave de filtro de aceite en espiral

3 patas

Chave de filtros de óleo espiral

3 garras



Art.	Ø mm
30652	45-75



Self gripping oil filter spiral wrench

3-arms

Llave de filtro de aceite en espiral

3 patas

Chave de filtros de óleo espiral

3 garras



Art.	Ø mm
30614	80-120



Pro swivel oil filter wrench
Llave de filtros articulada
Chave de filtros banda metálica

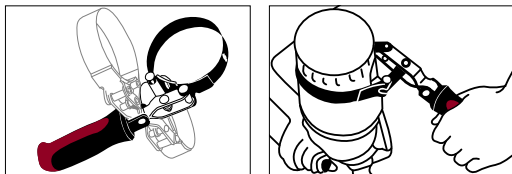

Art.	Ø mm
30616-076	60-76
30616-085	73-85
30616-099	85-99
30616-111	95-111



Pro swivel oil filter wrench
Llave de filtro articulada
Chave de filtros banda metálica

Art.	Ø mm
30617	65-110
30618	110-155



Swivel jaw filter wrench pliers

- can grip filters
- slipping around the filters is avoided by 6 heavy claws on each jaw

Alicate para filtros de aceite

- puede agarrar filtros
- evita el deslizamiento alrededor de los filtros 6 puntos de agarre fuertes en cada garra

Alicate de filtros ajustável

- os filtros podem apertar
- o deslizamento em torno dos filtros é evitado pelas seis garras pesadas em cada maxila

Art.	Ø mm	L1 mm
30615-120	57-120	325
30615-190	80-190	400

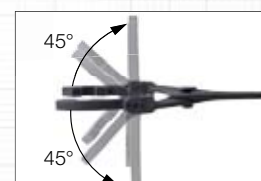

Cup type oil filter wrench kit
Juego de cazoletas para filtros de aceite
Jogo chaves filtros tipo taça



inclusive
 incluido
 incluido



↕ 565 × 382 × 88 mm

Art.	Ø mm
30619	65-120

Art.	Dim.		Art.	Dim.	
30619-66×6	× 66 mm (2-19/32") × 6 flutes × 1 step	Fiat Punto 1.2 / Renault Clio 1.2; Express; Kangoo; Rapid; Twingo	30619-86×16	× 86 mm (3-3/8") × 16 flutes × 1 step	Volvo S40; S60; S70; S80 etc.
30619-65×14	× 65 mm (2-9/16") × 14 flutes × 1 step	Champ / Daihatsu / Fiat / GM/AC / Hastings / Purolator / Napa / Nissan Toyota / Wix etc.	30619-86×18	× 86 mm (3-3/8") × 18 flutes × 1 step	VW Golf MK III. Tdi; Passat Tdi; Audi A6 Tdi; Renault Clio; Rapid 1.9D; Laguna; Safrane; Espace 2.1D, Citroën; Peugeot; Renault etc.
30619-65×67	× 65-67 mm (2-9/16"-2/21/32") × 14 flutes × 2 steps	Filters as made in Canada incl.: Daihatsu / PH4386 / PH4967 / PH6017 / PH6018 / Toyota etc.	30619-90×15	× 90 mm (3-17/32") × 15 flutes × 1 step	Honda Accord; Mitsubishi; Mopar; Isuzu etc.
30619-68×14	× 68 mm (2-11/16") × 14 flutes × 1 step	Hastings / Mazda; Ford Escort; Capri; Subaru; Fran PH6607 (Fran filters made in Korea); Motorcraft FL861 etc.	30619-92×10	× 92 mm (3-40/64") × 10 flutes × 1 step	Fiat Cinquecento; Coupe; Cromia; Panda; Regata; Ritmo; Fiat Seicento; Tempra; Tipo; Lancia Beta; Dedra; Kappa; Monte; Carlo; Prisma; Thema; Trevi etc.
30619-73×14	× 73 mm (2-7/8") × 14 flutes × 1 step	Toyota Lexus etc.	30619-93×15	× 93 mm (3-21/32") × 15 flutes × 1 step	Casite; Champ; Champion; GM; Fram Hastings; Opel; Mazda; Volvo; Mitsubishi; Purolator; Wix; Nissan; VW; Porsche; Renault; Ford; Honda; Audi etc.
30619-74×15	× 74 mm (3-29/32") × 15 flutes × 1 step	Audi #056-115-561g; Chrysler; GM; MF; Rover; etc.	30619-93×36	× 93 mm (3-21/32") × 36 flutes × 1 step	Motorcraft FL1A; FLA1B; FL300; FL820; Ford etc.
30619-74×76	× 74-76 mm (3-29/32 - 3") × 15 flutes × 2 steps	Ac; Audi; Ford; Fram; Mercedes; Opel; Saturn; VW etc.	30619-93×45	× 93 mm (3-21/32") × 45 flutes × 1 step	VW; Audi Tdi 2.4, 2.6, 2.8L etc.
30619-75×77	× 75-77 mm (3-15/16"-3-1/32") × 15 flutes × 2 steps	VW; Audi; Casite; GM/AC; Hastings; Wix; NAPA Ford; Isuzu; Mercedes; Opel etc.	30619-95×15	× 95 mm (3-6/8") × 15 flutes × 1 step	Toyota 5600; 41010; Alfa Romeo; GM; Ford; Chrysler etc.
30619-76×12	× 76 mm (3") × 12 flutes × 1 step	Fiat Ducato; Scudo; Ulysee; Renault; Megane / Laguna / Espace III.; Mercedes	30619-96×18	× 96 mm (3-3/4") × 18 flutes × 1 step	Audi Ar.A6, Tdi; VW Passat 97 Tdi; Renault Laguna 2.2D; Safrane 2.2D; Espace 2.2D.R19; Rapid; Megane 1.9 2.1D Tdi etc.
30619-76×14	× 76 mm (3") × 14 flutes × 1 step	Champion; Champ Lee; Purolator; Mopar; VW; Porsche; Mercedes; BMW; Audi I.B A3TD; Opel etc.	30619-100×15	× 100 mm (4") × 15 flutes × 1 step	Fram Motorcraft; Wix; Isuzu; Mitsubishi etc.
30619-76×30	× 76 mm (3") × 30 flutes × 1 step	Ford; Motorcraft FL400A etc.	30619-106×15	× 106 mm (4-11/64") × 15 flutes × 1 step	Fiat Ducato 2.5D. Td etc.
30619-76×8	× 76 mm (3") × 8 flutes × 1 step	Fiat Marea; Lancia Delta etc.	30619-108×15	× 108 mm (4-8/32") × 15 flutes × 1 step	Volvo C70; S70; V70; Tdi; TD; Turbo Diesel 850 Tdi; Diesel etc.
30619-76×15	× 78 mm (3-2/32") × 15 flutes × 1 step	Ford; Nissan 15208H8991; Toyota Accord etc.	30619-108×18	× 108 mm (4-8/32") × 18 flutes × 1 step	Renault Espace; Laguna; Master; Safrane; Traffic 2.4; 2.5; 2.8D TD etc.
30619-80×15	× 80 mm (3-9/64") × 15 flutes × 1 step	Fram; Hastings; Honda; Isuzu; Mazda; Motorcraft; Nissan; Opel; Purolator; Subaru; Toyota etc.	30619-120	65-120 mm	
30619-80×82	× 80-82 mm (3-9/64"-3-7/32") × 15 flutes × 2 steps	Wix Filters branded for: Mazda; Subaru; Toyota; Honda; Acura; Nissan; NAPA etc.	30619-1238		

Cup type oil filter wrench kit
Juego de cazoletas para filtros de aceite
Jogo chaves filtros tipo taça



inclusive
incluido
incluído



410 × 265 × 80 mm

Art.	Ø mm
30620	65-100



Art.	Dim.		Art.	Dim.	
30619-65×14	× 65 mm (2-9/16") × 14 flutes × 1 step	Fiat; Champ; Hastings; GM/AC; Wix; Napa; Purolator; Daihatsu; Toyota; Nissan etc.	30619-80×15	× 80 mm (3-9/64") × 15 flutes × 1 step	Hastings; Fram; Purolator; Nissan; Honda; Motorcraft; Mazda; Isuzu; Subaru; Opel; Toyota etc.
30619-65×67	× 65-67 mm (2-9/16"-2/21/32") × 14 flutes × 2 steps	Filters as made in Canada incl.: PH4386; PH4967; PH6017; PH6018; Daihatsu, Toyota etc.	30619-80×82	× 80-82 mm (3-9/64"-3-7/32") × 18 flutes × 1 step	Wix Filters branded for: Mazda; Subaru; Toyota; Honda; Acura; Nissan; NAPA etc.
30619-68×14	× 68 mm (2-11/16") × 14 flutes × 1 step	Hastings; Mazda; Ford Escort; Capri; Subaru; Fran PH6607 (Fran filters made in Korea); Motorcraft FL861 etc.	30619-90×15	× 90 mm (3-17/32") × 15 flutes × 1 step	Honda Accord; Mitsubishi; Mopar; Isuzu etc.
30619-73×14	× 73 mm (2-7/8") × 14 flutes × 1 step	Toyota Lexus etc.	30619-93×15	× 93 mm (3-21/32") × 15 flutes × 1 step	Casite; Champ; Champion; GM; Fram Hastings; Opel; Mazda; Volvo; Mitsubishi; Purolator; Wix; Nissan; VW; Porsche; Renault; Ford; Honda; Audi etc.
30619-74×76	× 74-76 mm (3-29/32-3") × 15 flutes × 2 steps	Opel; Ford; VW; Audi; Mercedes; Fram; Ac; Saturn etc.	30619-93×36	× 93 mm (3-21/32") × 36 flutes × 1 step	Motorcraft FL1A; FLA1B; FL300; FL820; Ford etc.
30619-75×77	× 75-77 mm (2-15/16"-3-1/32") × 15 flutes × 2 steps	VW; Audi; Casite; GM/AC; Hastings; Wix; NAPA Ford; Isuzu; Mercedes; Opel etc.	30619-100×15	× 100 mm (4") × 15 flutes × 1 step	Fram Motorcraft; Wix; Isuzu; Mitsubishi etc.
30619-76×14	× 76 mm (3") × 14 flutes × 1 step	Champion; Champ Lee; Purolator; Mopar; VW; Porsche; Mercedes Benz; BMW; Audi I.B A3TD; Opel etc.	30619-1238	 	
30619-76×30	× 76 mm (3") × 30 flutes × 1 step	Motorcraft FL400A; Ford etc.			

Cup type oil filter wrench for trucks
Juego de cazoletas para filtros de aceite
Jogo chaves filtros tipo taça

1/2" 21 mm 115 Nm 85 Lb.ft 9 PCS



480 x 305 x 90 mm

Art.	Dim.	
30621	× 36 mm × 6 flutes × 1 step	Mercedes (Axor BR400, Atego BR900, Actros BR500), Scania (PDE V8-Motor, HPI-Motor)
	× 76 mm × 14 flutes × 1 step	Mercedes (Sprinter Motor Version 600), VW Transporter
	× 106 mm × 15 flutes × 1 step	Fiat (Ducato 2.5 D/TD), IVECO MAN (8-10 To. - Serie L 2000), Scania (PDE-Motor)
	× 107 mm × 15 flutes × 1 step	IVECO, Renault, Scania, Volvo
	× 108 mm × 15 flutes × 1 step	IVECO, Renault, Scania, Volvo
	× 108 mm × 18 flutes × 1 step	Opel (Movano), Renault Transporter (Master, Traffic 2.4; 2.5; 2.8 D/TD)
	× 135 mm × 18 flutes × 1 step	MAN (18-48 To. Serie F2000, TGA)
	× 21 mm × 12 PT	
 	 120 mm	

Oil service wrench
Llave especial para tapones de carter
Chave para bujões

CrV



Art.	mm	L mm
30622	8 x 10	220

Drain plug key with metal bar

suitable for all cars

Llaves universales de tapón de carter

apto para todos los coches

Kit de chaves para bujões

apropriado para todos os carros

Art.	mm	mm
30623	14 + 17	8 + 13
	10 + 12	11 + 3/8"
	9 + 5/16"	



Differential filter spanner

Llave de tuerca de filtro de aceite del embrague

Chave para filtros diferencial

Art.	mm	L mm	
30628	46	405	Škoda, VW



Oil drain plug socket set

on magnetic aluminum rail

Juego vasos para tapones de carter

sobre regleta magnética en aluminio

Jogo chaves parafusos drenagem

em suporte magnético de alumínio

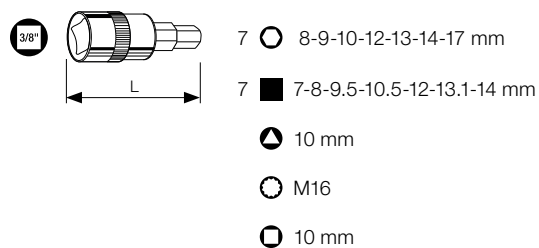

Art.	L mm
30010	35

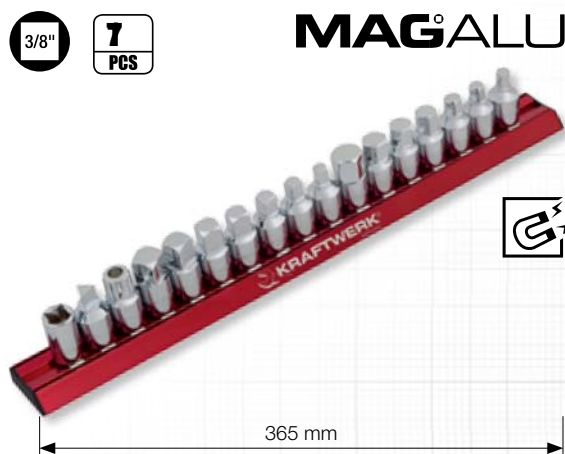

Info
KRAFTWERKtools.com/info/30010

Oil drainage pan

- with spout
- resistant to most solvents (T < 60°C), acids, alkalis, alcohols, oils, gasoline
- made of HDPE
- shock resistant



Recogedor de líquidos

- con boquilla
- resistente a mayoría de disolventes (T < 60°C), ácidos, alcalinos, alcoholes, aceites, gasolina
- fabricado en HDPE
- resistente a golpes

Receptor de oleo

- com cano
- resistente à maioria dos solventes (T < 60°C), ácidos, alcalinos, alcoóis, óleos, gasolina
- feito de PEAD
- resistente ao choque

Art.	Cap. L
30624	3.5
30625	8
30626	16

Oil drainage pan set

- with spout
- resistant to most solvents (T < 60°C), acids, alkalis, alcohols, oils, gasoline
- made of HDPE
- shock resistant



3.5 lt.
8 lt.
16 lt.

Recogedor de líquidos, set de 3 unidades

- con boquilla
- resistente a mayoría de disolventes (T < 60°C), ácidos, alcalinos, alcoholes, aceites, gasolina
- fabricado en HDPE
- resistente a golpes

Receptor de oleo, conjunto de 3 unidades

- com cano
- resistente à maioria dos solventes (T < 60°C), ácidos, alcalinos, alcoóis, óleos, gasolina
- feito de PEAD
- resistente ao choque



Art.

30624-26

Oil filler

with return flow valve

Suministrador de aceite

con válvula antiretorno

Dispensador de óleo

com válvula de retenção



Art.			
30653	AT-101		Ford (1/8" NPT)
	AT-102		Universal
	AT-103		Audi, VW
	AT-104		Audi, Porsche, VW
	AT-105		Audi, Mini Cooper (M10 x 1.0 mm), VW
	AT-106		Altis 2010, Benz 722.9 (M12 x 1.5 mm)
	AT-107		Audi, DSG (M24 x 1.5 mm), VW
	AT-108		Audi, CVT (M22 x 1.5 mm), VW

7.5 L

8 PCS



± 255 x 155 x 45 mm



Oil drain pan repair set

Juego para reparación del tapón del carter

Conjunto para reparar bujões

Art.
30627



± 305 x 235 x 55 mm

CrMo				Alu		
						Audi, BMW, Citroën, Mercedes, Fiat, Ford, Honda, Mazda, Mitsubishi, Nissan, Opel, Peugeot, Porsche, Renault, Saab, Seat, Škoda, Toyota, Volvo, VW etc.
M13	30627-M13T 1x M13 x 1.5	30627-M13B 5x M13 x 1.5	30627-M13S 10x M13 x 1.5			
M15	30627-M15T 1x M15 x 1.5	30627-M15B 5x M15 x 1.5	30627-M15S 10x M15 x 1.5			
M17	30627-M17T 1x M17 x 1.5	30627-M17B 5x M17 x 1.5	30627-M17S 10x M17 x 1.5			
M20	30627-M20T 1x M20 x 1.5	30627-M20B 5x M20 x 1.5	30627-M20S 10x M20 x 1.5			

Universal radiator pressure set

suitable for all common vehicle types

Juego para comprobar circuitos de refrigeración

para los vehículos más comunes

Kit teste pressão de radiadores

adequado para os veiculos mais comuns



Art.	 max. bar
31113	0-2.5 bar (+/- 2%)

	<p>Acura, Alfa Romeo, Audi, BMW, Buick, Cadillac, Chevrolet, Chrysler, Citroën, Daewoo, Dodge, Eagle, Fiat, Ford, Geo, GM, Honda, Hyundai, Infiniti, International, Isuzu, Jaguar, Jeep, Kia, Land Rover, Lexus, Mazda, Mercedes, Mercury, Mini Cooper, Mitsubishi, Nissan, Oldsmobile, Opel, Peugeot, Pontiac, Porsche, Renault, Saab, Saturn, Sterling, Ssangyong motor, Subaru, Suzuki, Toyota, Volvo, VW</p>
---	--

21
PCS



465 × 410 × 105 mm



Info
[KRAFTWERKtools.com/info/31113](https://www.KRAFTWERKtools.com/info/31113)



Flexible hose clamp

with automatic clamping device

- required for quickly and easy opening of the new turbo hose clamps
- especially suitable for difficult to reach areas by remote control

Alicate flexible para abrazaderas elásticas

con mecanismo automático de cierre

- apertura rápida y fácil de las nuevas abrazaderas
- especial para sitios de difícil acceso

Alicate de abraçadeiras flexível

com dispositivo de aperto automático

- necessário para a rápida e fácil abertura das novas abraçadeiras de mangueira turbo
- especialmente indicado para áreas de difícil acesso por controle remoto





Art.	L1 mm	L2 mm	
30644	0-52	650	Audi, VW

Hose clamp

Estrangulador de manquitos

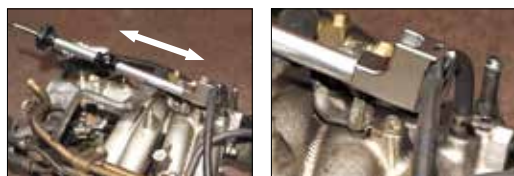
Alicate para abraçadeiras



Art.		max. mm	L mm
30629		25.4	310



Fluid line clamp set

Set pinzas para fluidos

Kit de Oclusão de tubos

Art.	Ø mm
31122	~ 10 mm (3/8")
	~ 15 mm (1/2")
	~ 25 mm (1")
	~ 45 mm (1-3/4")

4
PCS

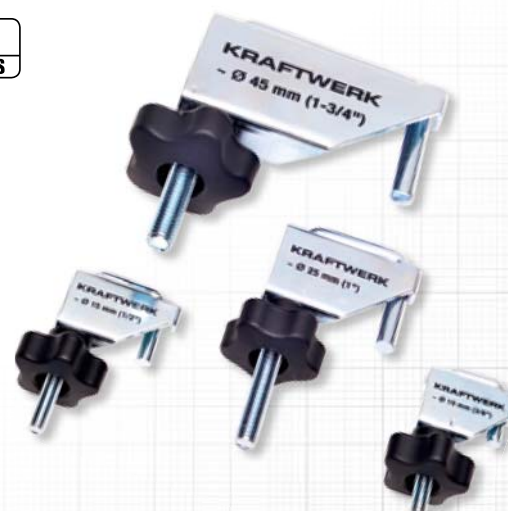

Corbin style hose clamp pliers

with ratcheting function for hose clamps,
incl. interchangeable jaws (2 pairs)

Alicate para abrazaderas elásticas con retención

con función de carraca, incluye bocas intercambiables (2 pares)

Alicate de abraçadeiras

com a função de roquete para abraçadeiras de mangueira,
incl. mandíbulas intercambiáveis (2 pares)

Art.	L mm
30645	220



Hose clamp

Alicate para abrazaderas

Alicate de abraçadeiras

Art.	L mm
30646	235



Hose clamp, 45° angled

Alicate angular para abrazaderas, 45°

Alicate angular de abraçadeiras, 45°

Art.	L mm
30647	220



Hose clamp

Alicate para abrazaderas

Alicate de abraçadeiras

Art.	L mm
30649	265



Engine timing tool set
Juego de calado de distribución VAG
Kit de ferramentas bloqueio

Art.	Pos.	
31401	1	Audi A2 1.2, 1.4 TD A4 1.6, 1.8, 1.9, 2.0 A6 1.8T, 1.8 AJP, 1.9 TDI VW Golf, Passat 1.6, 1.8, 1.8 T, Lupo 3L 1.2 TDI, Polo 1.4 TDI, Bora, Beetle, Sharan 1.9 TDI
	2	Audi V6 + V8
	3	Audi Seat Škoda VW 1.9D / SD / SDI / TD / TDI
	4	VW SW22
	5	Audi A3 1.8, 1.8 T A6 1.8 AJP TT 1.8 T Seat Ibiza, Cordoba 1.8 T, Toledo 1.8, Leon 1.8 T, Alhambra 1.8 T Škoda Octavia 1.8 T VW Golf, Bora 1.8 T, Beetle 1.8 T, Passat 1.8, Sharan 1.8 T
	6	Audi A8 3.3 TDI V8 VW 2.5 TDI V6



↕ 290 × 190 × 50 mm

Engine timing tool set
Juego de calado de distribución VAG
Kit de ferramentas bloqueio

Art.	
31407	Audi A2, A3, A4, A6, S3, TT, 80
	Seat Alhambra, Arosa, Cordoba, Ibiza, Inca, Leon, Toledo
	Škoda Fabia, Octavia
	VW Bora, Caddy, Fox, Golf, Lupo, New Beetle, Passat, Polo, Sharan, Touran



↕ 590 × 160 × 60 mm

Engine timing tool set
Juego de calado de distribución PSA
Kit de ferramentas bloqueio

Art.	
31406	Citroën AX, Berlingo, C2, C3, C5, C15, C25, Dispatch, Evasion, Jumper, Jumpy, Relay, Synergie, Visa, Xantia, XM, Xsara, ZX
	Peugeot Boxer, Expert, Express, Partner, 106, 205, 206, 305, 306, 307, 309, 405, 406, 406 Coupé, 605, 607, 806, 807



↕ 590 × 260 × 62 mm

Engine timing tool set

Juego de calado de distribución

Kit de ferramentas bloqueio

Art.	Pos.	RENAULT
31402	1	Clio, Kangoo, Laguna, Megane, Scenic
	2	Master, Trafic
	3	Master, Trafic
	4	Clio, Clio Williams, Espace, Express, Fuego, Kangoo, Laguna, Master, Megane, Rapid, R5, R9, R11, R18, R19, R20, R21, R25, R30, Scenic, Safrane, Trafic
	5	Espace, Laguna, Safrane
	6	Laguna, Safrane
	7	Clio, Twingo, Kangoo, Extra, Express, Rapid, R18, R19, R25, Kangoo, Fuego, Espace, Trafic, Master, Megane, Scenic, Safrane
	8	-
	9	Espace, Fuego, Master, R18, R20, R21, R25, R30, Trafic
	10	Laguna, Safrane
	11	Laguna
	12	Clio, Espace, Laguna, Megane, Scenic
	13	Clio, Kangoo, Twingo
	14	Clio, Laguna, Megane, Scenic
	15	Clio, Kangoo, Twingo
	16	Clio, Clio Williams, Espace, Express, Extra, Kangoo, Laguna, Megane, Rapid, R19, Scenic



450 x 490 x 78 mm

Engine timing locking tool set

for many types of engines

- tool for locking the crankshaft timing belt pulley for TDI pump injector engines
- flywheel locking tool

Juego universal de calado de distribución

para muchos tipos de motores

- herramienta para bloquear árboles de levas y cigüeñales para motores gasolina y diesel
- herramientas de sujeción de volante

Kit de ferramentas bloqueio

para muitos tipos de motores

- ferramenta para travar a polia da correia dentada da cambota para bomba injetora de motores TDI
- ferramenta de bloqueio de volante

Art.	
31405	Audi, Citroën, Fiat, Ford, Opel (Vauxhall), Peugeot, Renault, Rover, Saab, Seat, VW



Info
KRAFTWERKtools.com/info/31405

16
PCS



450 x 320 x 55 mm

Universal pulley holder and fan clutch

- ideal for almost all types of vehicles
- universal tool for locking, turning and holding of perforated pulleys
- the total length of 520 mm guarantees an optimal lever for releasing the pulley mounting screws
- including 4 pairs of screw-in studs

Bloqueador de poleas

- ideal para casi todo tipo de vehículos
- herramienta universal para bloqueo y sujeción de poleas dentadas
- largo total 520 mm garantiza la sujeción óptima para sustitución de correas y tensores
- incluye 4 pares de pivotes

Bloqueador de polias universal

- ideal para quase todos os tipos de veículos
- ferramenta universal para o bloqueio, e detenção de polias perfuradas
- o comprimento total de 520 milímetros garante uma segurança ideal para substituição de correias e tensores
- incluindo 4 pares de pinos de parafuso-in

Art.	Ø mm
30650	40-220

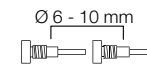
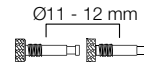
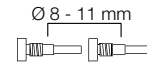
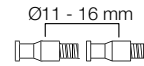

↔ 710 × 105 × 55 mm

Universal tension gauge for cam belts

- for adjusting initial tension of the drive belt
- one rotation of the adjusting nut corresponds to the piston load of approx. 10 Nm
- tension can be read on front and rear of the tool

Tensiómetro de correas

- para el ajuste de la tensión inicial de la correa de transmisión
- un giro de la tuerca de ajuste de carga de pistón aprox. 10 Nm
- la tensión se puede leer en la parte delantera y trasera de la herramienta

Verificador tensão da correia

- para o ajuste da tensão inicial da correia de transmissão
- uma rotação da porca de ajuste corresponde a uma pressão aproximada de 10 Nm
- a tensão pode ser visualizada na parte da frente e traseira da ferramenta



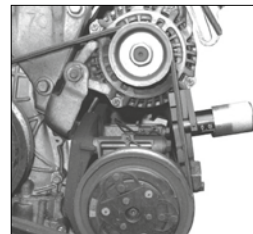









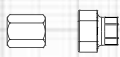





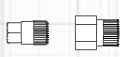























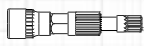



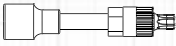

Art.	360°
30415	1 mm / 10 Nm

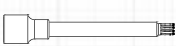

Combined socket set for alternator repair kit set
Juego extractores para polea de alternador
 Jogo ferramentas para alternadores

18
PCS







- | | | | |
|--|----------------|--|--|
|  | Bosch |  17 mm |  Ø 35 mm |
|  | Renault |  22 mm |  22 mm |
| | |  28 mm |  22 mm |
| | |  28 mm |  19 mm |
|  | Spline |  15 mm |  3 |
| | |  22 mm |  3 |
|  | |  12 mm |  64 mm |
| | |  |  M10 |
|  | |  1/2" |  10 mm |
|  | |  10 mm |  75 mm |
| | |  |  T40-T50 |
| | |  10 mm |  M8-M10 |
| | |  10 mm |  75 mm |
| | |  |  8-10 mm |
|  | |  3/8" |  82 mm |
| | |  |  M10 |
|  | |  1/2" |  113 mm |
| | |  |  M10 |
| | |  1/2" |  113 mm |
| | |  |  T50 |
|  | |  1/2" |  141 mm |
| | |  |  M10 |

Art.	
30612	Bosch, Fiat, Marelli, New Renault, Valeo

↕ 270 × 185 × 60 mm

Air conditioning spring locking coupling tool set
Juego de desconexión de tubos de aire acondicionado
 Jogo de desconectores de tubos ar-condicionado

Art.	
30603	 3/8"
	 1/2"
	 5/8"
	 3/4"
	new Chrysler & Jeep, Ford 1981-



Fuel tank sender spanner set

- adjustable and universal usage
- for loosening and tightening the plastic locking ring of the fuel sender unit on the fuel tank

Llave para desmontar tapas de aferradores

- ajustable, para uso universal
- para aflojar y apretar aferradores de depósito de combustible

Chave para tanques de combustível

- utilização ajustável e universal
- para apertar e desapertar o anel de bloqueio de plástico da unidade de emissor de combustível no tanque de combustível

Art.	L mm
30605	75-160



Hose clamp pliers

Alicate para abrazaderas de escape

Alicate abraçadeiras de escape

Art.	L mm
30012	300





4

Body work, Installation / Removal tools

Útiles carroceria

Ferramenta de carrossaria

Body workshop trolley

universal composition with a set of special body repair tools in the 3rd drawer.

Carro para taller de carrocería

con herramientas universales y con un juego de herramienta especial para taller de carrocería en el 3er cajón.

Carro de ferramentas para oficina de carroçaria

fornecido com ferramentas universais e com um conjunto de ferramentas especiais para bate-chapas na terceira gaveta.

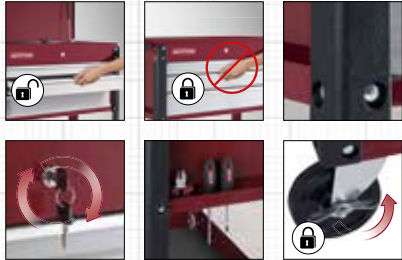

	L1 / mm	L2 / mm	L3 / mm	Δ kg
	792	445	960	160
A	690	410	104	40
B	650	355	45	20
C	650	355	68	30
D	650	355	100	30
E	768	410	40	40

Art.			
3917-4919+3	3917	3	G1.006

176
PCS

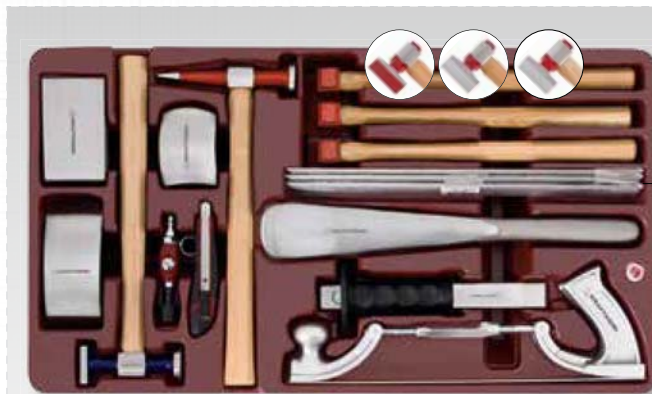

16
PCS



Art. 4919-03

- 1 Car body file holder 350 mm
Lima carrocerero 350 mm
Lima de Bate-chapas 350 mm
- 3 Car body file blade
Hoja angular para lima carrocerero
Lima radial de bate-chapas
- 1 Car body spoon
Cuchara carrocerero
Colher de bate-chapas
- 1 Car body chisel
Buril carrocerero
Cinzel com punho
- 1 Mini air blow gun with turbo power nozzle
Mini sopladora con efecto turbo.
Mini soprador turbo
- 1 Snap-Off Knife
Cúter
X-acto

- 1 Wedge dolly
Tas cuña
Encontrador punta
- 1 Curved dolly
Tas coma
Encontrador virgula
- 1 High crowned dolly
Tas americano
Encontrador curvo
- 1 Planishing hammer
Martillo combi para desabollar y alisar.
Martelo plano faces polidas
- 1 Bumping hammer
Martillo combi con bola para desabollar y alisar.
Martelo cabeça redonda plana e ponta
- 1 Bumping and planishing hammer serrated face
Martillo acanalado para desabollar y alisar.
Martelo plano serrilha
- 1 Bumping and planishing hammer flat face
Martillo cabeza plana para desabollar y alisar.
Martelo plano liso
- 1 Bumping and planishing hammer bowed face
Martillo cabeza abombada
Martelo plano angular

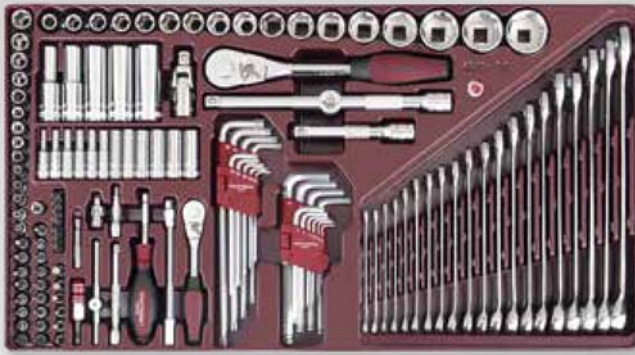

132
PCS



ergokraft

Art. 4919-01

- 14 3.5-4-4.5-5-5.5-6-7-8-9-10-11-12-13-14 mm
- 12 4-4.5-5-5.5-6-7-8-9-10-11-12-13 mm
- 3 4-5.5-6.5 mm
- 3 PH 1-2-3
- 3 PZ 1-2-3
- 8 T8-T10-T15-T20-T25-T27-T30-T40
- 6 3-4-5-6-7-8 mm
- 1/4" 1/4"
- 1/4" 1/4"
- 2 50 mm / 100 mm
- 150 mm
- 115 mm
- 1/4" 1/4"
- 7 T10-T15-T20-T25-T27-T30-T40
- 1/4" 1/4"
- 1/4" 1/4"
- Art. 3200

- 17 10-11-12-13-14-15-16-17-18
19-21-22-24-27-30-32-34 mm
- 5 10-13-17-19-22 mm
- 1/2" 1/2"
- 2 125 mm / 250 mm
- 3/8" 1/2"
- Art. 3220
- Art. 3602
DIN 2936 S2 1.5-2-2.5-3-4-5-6-7-8-10 mm
- Art. 3607
XXL S2 T10-T15-T20-T25-T27
T30-T40-T45-T50

- Art. 3505 5.5 mm
- Art. 3506 6 mm
- Art. 3507 7 mm
- Art. 3508 8 mm
- Art. 3509 9 mm
- Art. 3510 10 mm
- Art. 3511 11 mm
- Art. 3512 12 mm
- Art. 3513 13 mm
- Art. 3514 14 mm
- Art. 3515 15 mm
- Art. 3516 16 mm
- Art. 3517 17 mm
- Art. 3518 18 mm
- Art. 3519 19 mm
- Art. 3520 20 mm
- Art. 3521 21 mm
- Art. 3522 22 mm
- Art. 3523 23 mm
- Art. 3524 24 mm



Art. 4919-02

- S2 Art. 4110-1 0.6 x 3 mm
- Art. 4110-2 0.8 x 4 mm
- Art. 4110-3 1.0 x 5 mm
- Art. 4110-4 1.1 x 6 mm
- Art. 4110-5 1.2 x 8 mm
- S2 Art. 4112-2 1.1 x 6 mm
- S2 Art. 4115-1 PH1
- Art. 4115-2 PH2
- S2 Art. 4117-2 PH2
- Art. 2138 100-250 V
- Art. 2139 12 V

28
PCS

ergokraft

- DIN ISO 5746 Art. 3281-180 180 mm
- DIN ISO 5749 Art. 3282-160 160 mm
- DIN ISO 8976 Art. 3290-250 250 mm

- DIN ISO 5745 Art. 3285-200 200 mm

- DIN ISO 5232 Art. 3289-160 160 mm

- Art. 1350-2 2 mm
- DIN 6450 Form C Art. 1350-3 3 mm
- Art. 1350-4 4 mm
- Art. 1350-5 5 mm
- Art. 1350-6 6 mm
- Art. 1350-8 8 mm

- Art. 1358-2 No. 2
- DIN 7250
- Art. 3380-18 18 mm
- DIN 6451/53 Art. 3380-22 22 mm

- HICKORY Art. 2305 500 g
- DIN 1041

- HICKORY Art. 2336 Ø 35 mm

- Art. 4700-0316 3 m x 16 mm

Universal service tool set

for 2 additional drawers of the tool-cabinet 3917

Composición herramientas universales

para 2 cajones adicionales en el carro de taller 3917

Conjunto de ferramentas universais

para o carro de ferramentas 3917

160
PCS



1/4"

1/2"

1/4"

ergokraft

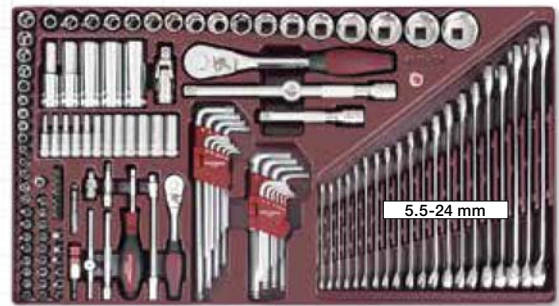

Art.

4919

Body file clamping fixture

without file

- for 350 mm file blades

- adjustable for flat and curved applications

Porta limas de carrozero

sin lima

- para limas de 350 mm

- para aplicaciones planas y curvas

Porta limas de chapeiro

sem lima

- para limas de 350 mm

- ajustável para aplicações planas e curvas

Art.

L
mm

30812

350

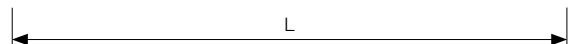

Body file

Lima de carrozero

Lima de chapeiro

Art.



L
mm

30813

9 / "



350

30814

12 / "



350

30815

15 / "



350

30816

9 / "



350

30817

12 / "



350



Single end planishing hammer, serrated
Martillo acanalado para desabollar y alisar
 Martelo plano de serrilha

Art.	L mm	g
30818	330	320

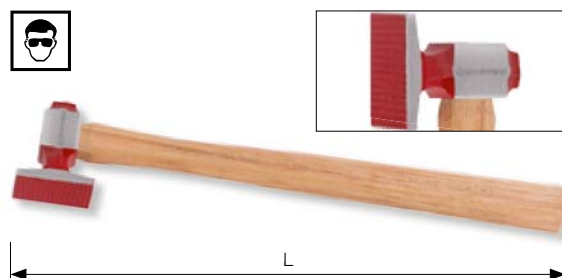

Single end planishing hammer, flat face
Martillo cabeza plana para desabollar y alisar
 Martelo plano liso

Art.	L mm	g
30819	330	320



Single end planishing hammer, bowed face
Martillo cabeza abombada para desabollar y alisar
 Martelo plano angular

Art.	L mm	g
30820	340	320

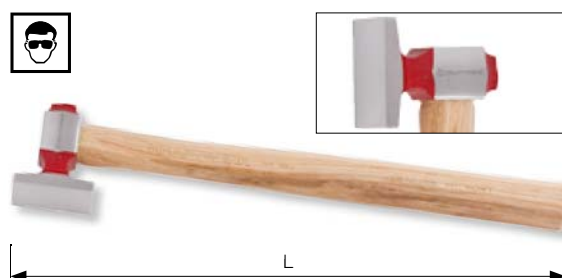

Planishing hammer
Martillo combi para desabollar y alisar
 Martelo plano

Art.	L mm	g
30821	330	390



Bumping hammer
Martillo combi de pico y cabeza plana
 Martelo cabeça redonda plana e ponta

Art.	L mm	g
30822	330	460

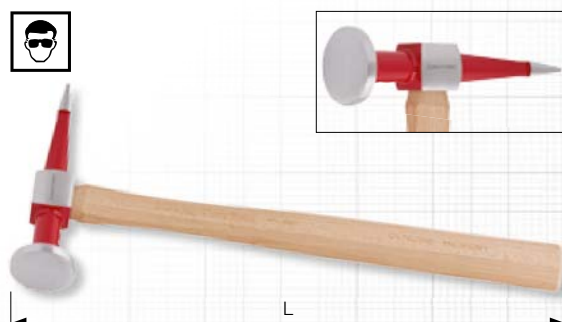

High crowned dolly
Tas americano
 Encontrador curvo

Art.	L mm	g
30823	85	1000



Wedge dolly
Tas de cuña
 Encontrador tipo cunha

Art.	L mm	g
30824	110	800



Curved dolly
Tas de coma
 Encontrador tipo vírgula

Art.	L mm	g
30825	135	1625



Car body spoon
Cuchara carrocerero
 Colher côncava

Art.	L mm	g
30826	390	1242



Chisel with straight cutter and hand guard,
 extra flat
Burril carrocerero con protección, extraplano
 Cinzel com cortante direito com punho de
 protecção, extra plano

Art.	L mm	g
30827	240	283



Multipurpose shelf trolley

with accessory kit for transporting windows and windshields.

Mesa de trabajo móvil

con kit de accesorios para el transporte de las ventanillas y parabrisas.

Carro multiuso de prateleiras

com kit de acessórios para o transporte de janelas e pára-brisas.

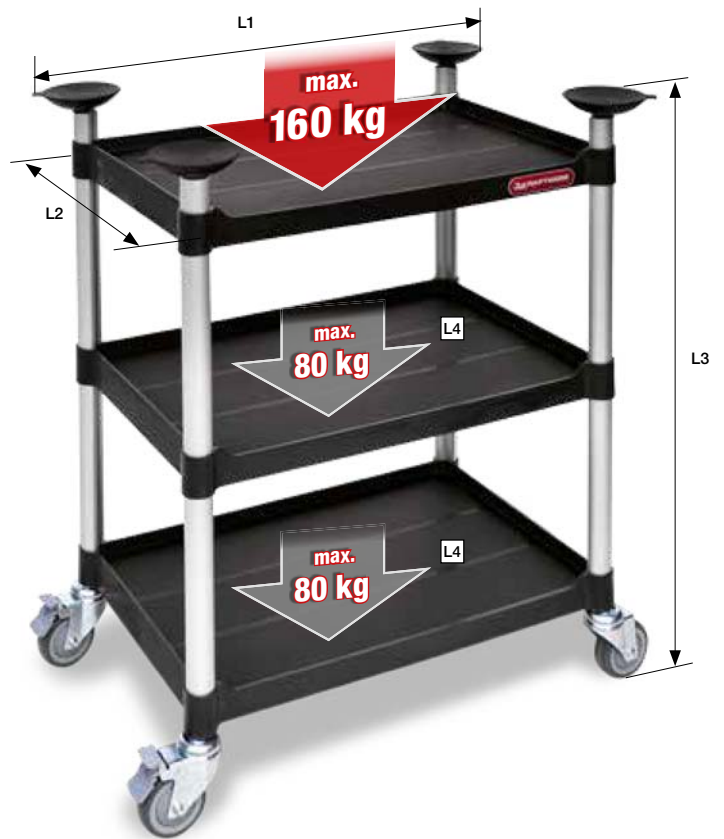

	L1 / mm	L2 / mm	L3 / mm
	845	490	1015
L4	660	390	300



Art.

3912A

Accessory kit for transporting windows and windshields

Kit de accesorios para el transporte de las ventanillas y parabrisas

Kit de acessórios para o transporte de janelas e pára-brisas



Accessories for
Art. 3912
 Accesorios para
Art. 3912
 Acessórios para
Art. 3912

Art.

3912-98



Double plunger elevator

- flexible suction cups and quick-release lever
- ideal for curved windscreens
- for lifting, carrying and holding
- for flat and non-porous surfaces
- special plastic

Ventosa para lunas

- flexible, de fácil liberación
- ideal para parabrisas curvos
- para levantar, transportar y sujetar
- para superficies planas y no porosas
- plástico especial

Ventosa dupla de sucção

- ventosas flexíveis com alavanca de libertação rápida
- ideal para os para-brisas curvos
- para elevar, transportar e segurar
- para superfícies planas e não porosas
- plástico especial

Art.	 kg	Ø mm	L mm
30802	max. 40	117	327

ABS

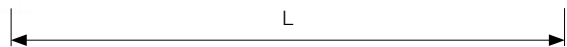
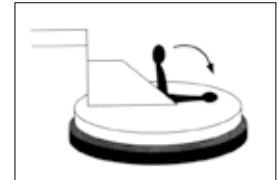

Double plunger elevator, aluminium

- flexible suction cups and quick-release lever
- ideal for curved windscreens
- for lifting, carrying and holding
- for flat and non-porous surfaces

Ventosa aluminio para lunas

- flexible, de fácil liberación
- ideal para parabrisas curvos
- para levantar, transportar y sujetar
- para superficies planas y no porosas

Ventosa dupla de sucção em alumínio

- ventosas flexíveis com alavanca de libertação rápida
- Ideal para os para-brisas curvos
- para elevar, transportar e segurar
- para superfícies planas e não porosas

Art.	 kg	Ø mm	L mm
30803	max. 50	117	327

Alu

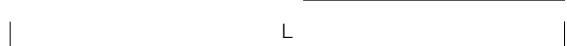
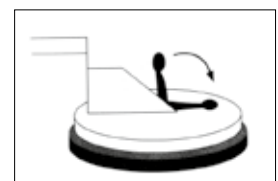

Windshield removing kit

- for cutting of adhesive beads
- with a steel tube hollow needle
- ergonomically shaped handles
- stainless steel wire

Conjunto cortador alambre para lunas

- para cortar masilla adhesiva
- con aguja hueca de acero
- tiradores ergonómicos
- alambre de acero inoxidable

Kit para retirar pára-brisas

- para recortar a massa adesiva
- pegas de forma ergonómicas
- fio de aço inoxidável

4
PCS



Art.

30804

Windshield removing / installation kit

- for removal and installation of pasted windscreens
- expendable material for approx. 30 windscreens

Conjunto para lunas

- para quitar e instalar lunas pegadas
- alambre de corte para aprox. 30 lunas

Conjunto de ferramentas para pára-brisas

- para remoção e instalação de para-brisas colados
- material descartável para aproximadamente 30 para-brisas



Art.

30805

30
PCS

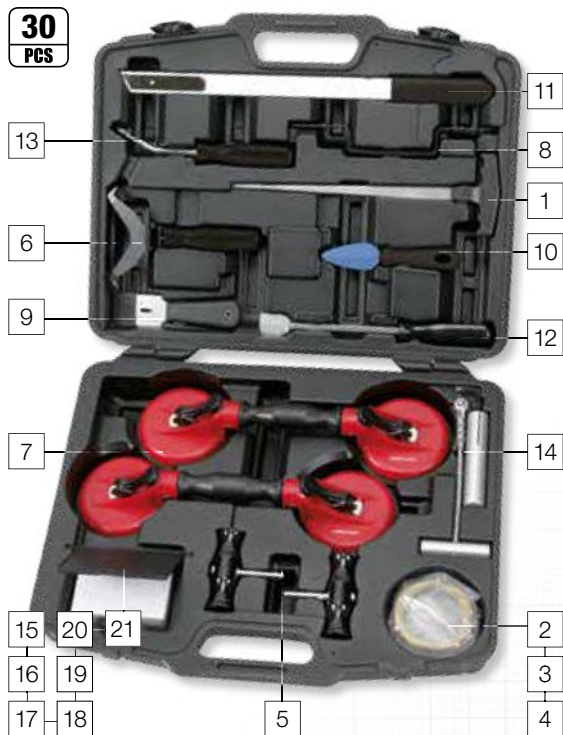

↕ 525 × 430 × 130 mm

Safety mini scraper

incl. 3 spare blades

Mini rascador con hoja retraible

incluye 3 hojas de recambio

Mini raspador

inclui 3 lâminas

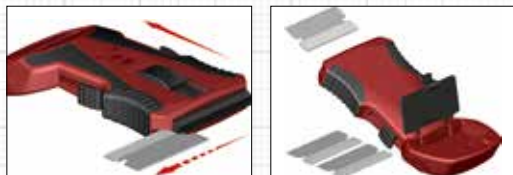

Art.	L mm
3338	118

Spare blades for the Safety mini scraper

Hojas de recambio para minirascador

Lâminas para o mini raspador

Art.	L mm
3338E	19

Airbag tool set

for disassembling the air bag unit and assembly /
disassembly of the airbag cushion.

Juego útiles para airbag

para montar / desmontar la unidad de airbag.

Jogo ferramentas para airbags

para desmontar a unidade de airbag e montar/desmontar
a almofada do airbag.

Art.	Pos.	
30811	1	Audi, BMW, Mercedes, Seat, Škoda, VW
	2	Audi A4/A6, VW Lupo, VW Passat, VW Polo
	3	Seat, Škoda Fabia, Škoda Octavia, VW Golf 4, VW New Beetle
	4	VW Bora, VW Golf 4, VW Passat
	5	VW
	6	T30: Audi, Opel, Renault, VW
	T30: Audi, BMW, Mercedes, Opel	
	T25: BMW	
	T25: BMW	
	5 mm: Audi	



10
PCS

HSS

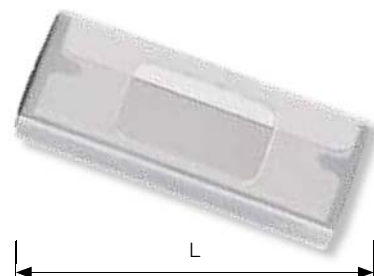

12
PCS



Windscreen wiper arm puller
Extractor de brazos de limpiaparabrisas
Saca limpa pára-brisas



Art.	L mm
30806	65

Wiper arm puller set

- allows trouble free disassembly of all current wiper arms
- perfect on rusty and stuck wiper arms
- helps protect nozzles inside the wiper arm by using the sliding hammer
- contains 1 sliding hammer, 1 pressure spindle, 6 sockets

Juego de extracción de brazos de limpiaparabrisas

- permite el desmontaje sin problemas de todos los brazos de limpiaparabrisas actuales
- perfecto para brazos oxidados y atascados
- ayuda a no dañar el brazo al extraerlo con barra deslizante
- incluye 1 barra deslizante, 1 husillo adaptador y 6 vasos

Jogo de sacas limpa pára-brisas

- permite a desmontagem sem problemas de todos os braços dos limpa pára-brisas
- perfeito para os braços oxidados e presos
- ajuda a proteger os injectores do interior dos braços utilizando o martelo deslizante
- contém 1 martelo deslizante, 1 eixo de pressão e 6 chaves

8
PCS



Art.	Pos.	
30807	1	Alfa-Romeo, Audi, BMW, Citroën, Fiat, Ford, Honda, Jaguar, Mazda, MB, Mercedes, MG-Rover, Mitsubishi, Opel, Peugeot, Renault, Seat, Škoda, Volvo, VW
	2	Alfa-Romeo, Audi, BMW, Citroën, Fiat, Ford, Honda, Hyundai, Jaguar, Land Rover, MB, Mercedes, Opel, Peugeot, Renault, Saab, VW
	3	Alfa-Romeo, Audi, BMW, Citroën, Fiat, Ford, Mazda, MB, Mitsubishi, Opel, Peugeot, Smart, Volvo, VW
	4	Citroën, Hyundai, MB, Mercedes, Opel
	5	Alfa-Romeo, Audi, BMW, Ford, Jaguar, Land Rover, Mazda, MB, Volvo, VW
	6	Citroën, Ford, Peugeot

✚ 325 x 250 x 80 mm

Expander pad set

- to spread e.g. door frames without damage to the paint
- for emergency opening
- hand pump with valve

Cuñas inflables

- para expandir los marcos de las puertas sin dañar la pintura
- para apertura de emergencias
- bomba manual con válvula

Conjunto de almofadas de encher bomba manual

- para colocar, por exemplo, nos caixilhos de portas sem danificar a pintura
- para aberturas de emergência
- bomba manual com válvula

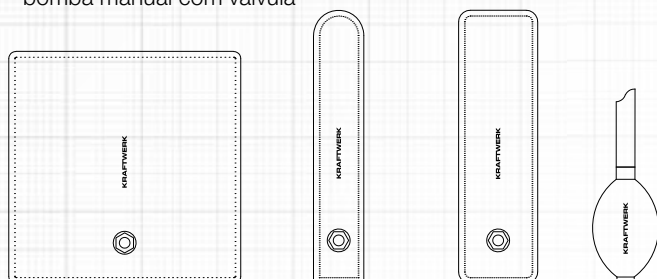

6 3/8" x 6 3/8"
160 x 160 mm

7" x 1 1/2"
180 x 38 mm

7 1/2" x 2 3/8"
190 x 60 mm

4
PCS



Art.

30801



Mounting wedge set

- various levers made of glass-fibre reinforced plastic
- for car interior linings, for a damage-free installation or removal of lining parts, plastic clips, rear view mirrors, etc. even in difficult to reach spots.

Juego sacamolduras interiores

- varias palancas plásticas para un montaje y desmontaje seguro en revestimientos de coches, clips de plástico, retrovisores, etc. especialmente diseñado para trabajos en lugares de difícil accesibilidad
- plástico reforzado

Jogo de ferramentas para guarnições

- várias alavancas fabricadas em fibra de vidro reforçado por plástico
- para revestimentos interiores do veículo, para uma instalação sem danos ou remoção de peças de revestimento, cliques de plástico, espelhos retrovisores, etc. mesmo em locais de difícil acesso.

11
PCS



Art.

30808



Clip remover set

stainless steel with 2-component plastic handles

Conjunto de quitagrapas

en acero inoxidable con mango plástico 2-componentes

Conjunto de tira molas

em aço inox com punho de plástico em bimatéria

Art.	L1 mm	L2 mm
30809	96	120

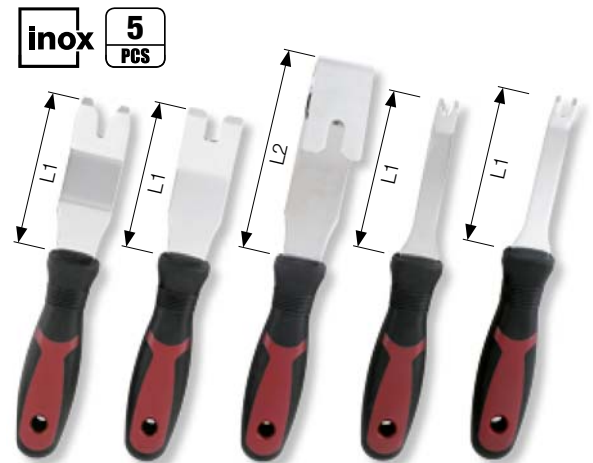

Detaching plier

- for loosening plastic clips on door trims, bumper straps, etc.
- avoids damage to all surfaces e.g. for door panels

Alicates para grapas

- para soltar clips plásticos en los tapizados de las puertas, correas, etc.
- mordazas acabadas en negro, fabricadas en láminas de acero endurecido

Alicate de clips

- para desprender os clips de plástico nos frisos das portas, tiras adesivas, etc.
- evita danos em todas as superfícies, por exemplo para painéis das porta

Art.	L1 mm	L2 mm
30648	240	32



Plastic scraper set

- for universal use
- for a quick and easy removal of glued on trim or for the removal of adhesive weights on aluminium wheels

Juego rascadores

- para el uso universal
- para una eliminación rápida y fácil del adhesivo en paneles interiores de las puertas etc, así como para la eliminación de los pesos adhesivos en ruedas de aluminio

Conjunto de raspadores

- para uso universal
- para uma remoção rápida e fácil das partes coladas na guarnição, ou para os pesos adesivos em rodas de alumínio

Art.	Pos.	L mm	→▲+ mm
30810	1	270	38
	2	270	25
	3	270	22
	4	270	19



Hand riveter

Remachadora manual

Alicate de rebitar manual

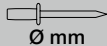
Art.	 Ø mm	L mm
2223	2.4-3.2-4.0-4.8	250



Nozzle for hand riveter

Boquilla para remachadora manual

Bico para alicate de rebitar manual

Art.	Ø mm
2223-2.4	2.4
2223-3.2	3.2
2223-4.0	4.0
2223-4.8	4.8



Pair of jaws for hand riveter

Par de bocas para remachadora manual

Mordentes para alicate de rebitar manual

Art.
2223-01





Hand riveter set

Kit remachadora manual

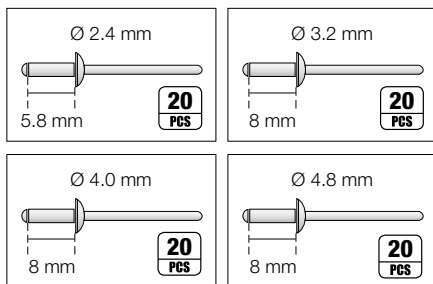
Conjunto de alicate de rebitar manual

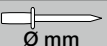

Art.	 Ø mm	 pcs.
2224	2.4-3.2-4.0-4.8	20





Industrial hand riveter tool case
Estuche de remachadora manual industrial
Kit de alicate de rebitar manual industrial

Alu steel inox

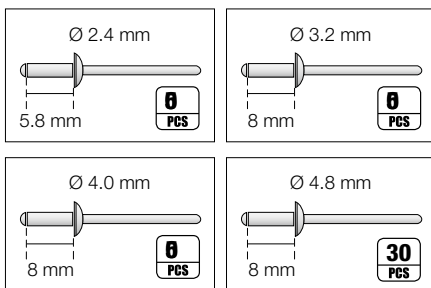
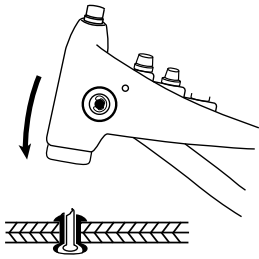
HIGHTECH

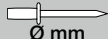

Art.	 Ø mm
4261	2.4-3.2-4.0-4.8

 320 x 148 x 48 mm

Nozzle for hand riveter
Boquilla para remachadora manual
Bico para alicate de rebitar manual

Art.	Ø mm
4261-1	2.4
4261-2	3.2
4261-3	4.0
4261-4	4.8



Pair of jaws for hand riveter
Par de bocas para remachadora manual
Mordentes para alicate de rebitar manual

Art.
4261-5



Industrial lever type hand riveter tool case
Estuche remachadora manual con efecto de palanca
 Kit de alicata de rebitar de brazos

Alu inox

HIGHTECH

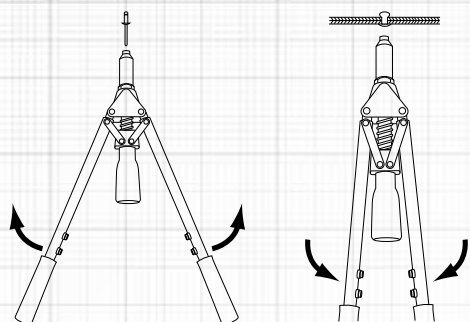

Art.	Ø mm
4262	3.2-4.0-4.8-6.0-6.4

575 x 185 x 52 mm

Nozzle for hand riveter
Boquilla para remachadora manual
 Bico para alicata de rebitar manual

Art.	Ø mm
4262-1	3.2
4262-2	4.0
4262-3	4.8
4262-4	6.0
4262-5	6.4



Nozzle Monobolt for hand riveter
Boquilla Monobolt para remachadora manual
 Nariz Monobolt para alicata de rebitar manual

Art.	Ø mm
4262-8	4.8/5 / MB
4262-9	6.4 / MB



Pair of jaws for hand riveter
Par de bocas para remachadora manual
 Mordentes para alicata de rebitar manual

Art.
4262-7





Industrial hand rivet nut tool case
Estuche de remachadora de tuerca industrial
 Kit de alicate de rebitar manual industrial

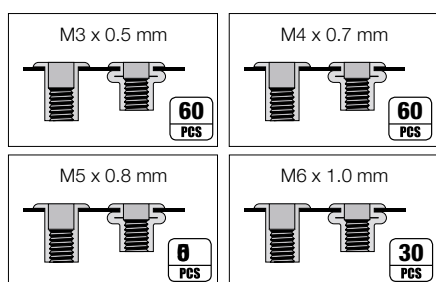

HIGHTECH



Art.	
4263	M3-M4-M5-M6

 320 x 148 x 48 mm

Rivet nut nozzle
Boquilla para remachadora manual
 Bico para alicate de rebitar manual

Art.	
4263-1	M3
4263-2	M4
4263-3	M5
4263-4	M6



Thread bolt for hand rivet nut tool
Repuesto para remachadora de tuerca
 Cabeça parafuso para alicate de rebitar

Art.	Ø
4263-5	M3
4263-6	M4
4263-7	M5
4263-8	M6



Industrial lever hand rivet nut tool kit
Remachadora industrial para tuercas remachables
 Kit de alicate de rebitar de braços industrial

Alu  inox

HIGHTECH

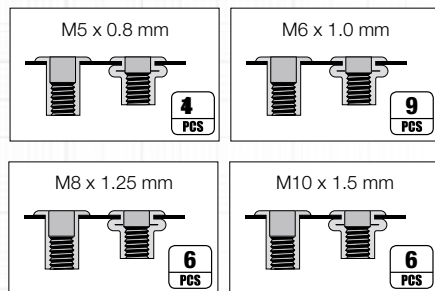

↕ 575 × 185 × 52 mm

Art.	
4264	M5-M6-M8-M10

Threaded mandrel and nose piece
Boquilla para remachadora de tuerca
 Mandril e bico para alicate de rebitar de braços industrial

Art.	
4264-1	M4
4264-2	M5
4264-3	M6
4264-4	M8
4264-5	M10



Grip pliers set

- Long nose grip pliers 10"/250 mm
- Grip pliers 7"/175 mm
- Long nose grip pliers 6"/150 mm

Juego tenazas

- Grip con boca larga 10"/250 mm
- Grip 7"/175 mm
- Grip con boca larga 6"/150 mm

Conjunto de alicates

- Alicates largo 10"/250 mm
- Alicates 7"/175 mm
- Alicates largo 6"/150 mm

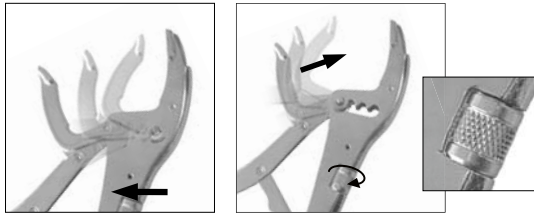

Art.	L1 mm	L2 mm	L3 mm / inch	
3292SET	3292-150	50	45	max. 150 / 6
	3292-175	43	-	max. 175 / 7
	3292-251	85	-	max. 150 / 10

CrMo **CrV** **3**
PCS

Art. 3292-251



Art. 3292-175



Art. 3292-150



Curved jaws locking pliers

Tenaza grip de bocas curvas

Alicate de pressão maxilas côncavas

Art.	L1 mm	L2 mm / inch
3292-175	43	max. 175 / 7
3292-250	58	max. 250 / 10

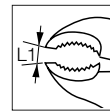

CrMo



Long nose locking grip pliers

Tenaza de precisión de bocas largas

Alicate de pressão bicos longos

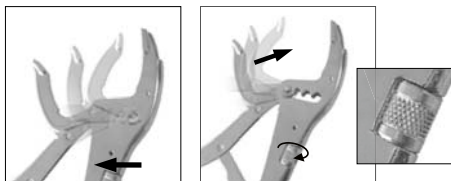

Art.	L1 mm	L2 mm	L2 inch
3292-251	85	250	10"

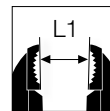

CrV



Long nose locking grip pliers
Tenaza grip de bocas largas
 Alicates de pressão bicos longos

Art.	L1 mm	L2 mm	L3 mm / inch
3292-150	50	45	max. 150 / 6

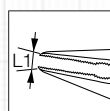

CrMo

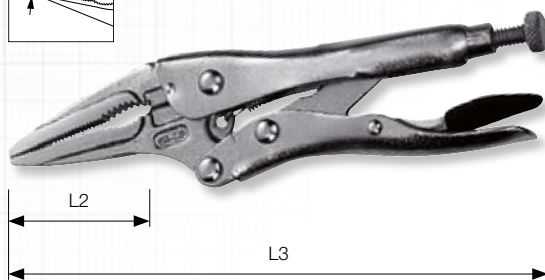

Sheet metal clamp
Tenaza grip para chapa
 Alicates de pressão para latoeiros

Art.	L1 mm	L2 mm	L3 mm / inch
2253-200	48	79	max. 200 / 8

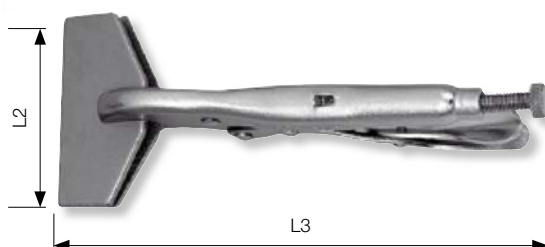
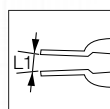

Locking welding clamp
Tenaza grip para soldador
 Alicates de pressão para soldadura

Art.	L1 mm	L2 mm / inch
2252-225	41	max. 225 / 9

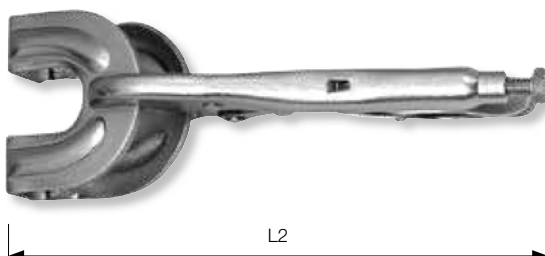
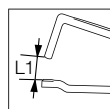

Locking „C”- clamp pliers
Mordaza grip de cuello de cisne
 Alicates de pressão pescoço de cisne

Art.	L1 mm	L2 mm	L3 mm / inch
2254-275	95	95	max. 275 / 11

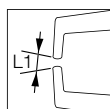

Plastic grip clamp set

Juego de pinzas de sujeción de plástico

Jogo de grampos multiuso plástico

Art.	L1 mm	L2 mm	L2 inch	PCS
2256	35	75	3	2
	40	100	4	2
	70	150	6	2
	85	225	9	2



Spatula, flexible

- flexible blade made of stainless steel, hardened and mirror polished
- bi-material soft grip handle with anti-slip grip

Espátulas, flexible

- lama flexível em aço inoxidável, reforçada e com acabamento polido brilhante
- mango bimatéria antiderrapante

Espátulas, flexível

- lâmina flexível em inox, reforçada e polida
- cabo em bimatéria anti-derrapante

Art.	B mm	L1 mm	L2 mm
3331-032	32	105	240
3331-050	50	105	245
3331-063	63	105	245
3331-075	75	105	245
3331-100	100	105	245
3331-125	125	105	245

inox flex



ergokraft



Universal spatula set

- flexible blades made of stainless steel, hardened and mirror polished
- bi-material soft grip handles with anti-slip grips

Juego de espátulas universales

- lamas flexíveis em aço inoxidável, reforçadas e com acabamento polido brilhante
- mangos bimatéria antiderrapantes

Jogo de espátulas universais

- lâminas flexíveis em inox, reforçadas e polidas
- cabos em bimatéria anti-derrapante

Art.	B mm
3335	32 - 50 - 75

inox flex 3 PCS



ergokraft

Straight body seam splitter

with 2-component handle

Palanqueta plana para carroceria

con mango bimatèrial

Ferramenta de chapeiro direita

cabos em bimatèria anti-derrapante

Art.	B mm	L1 mm	L2 mm
3334-01	24	154	302

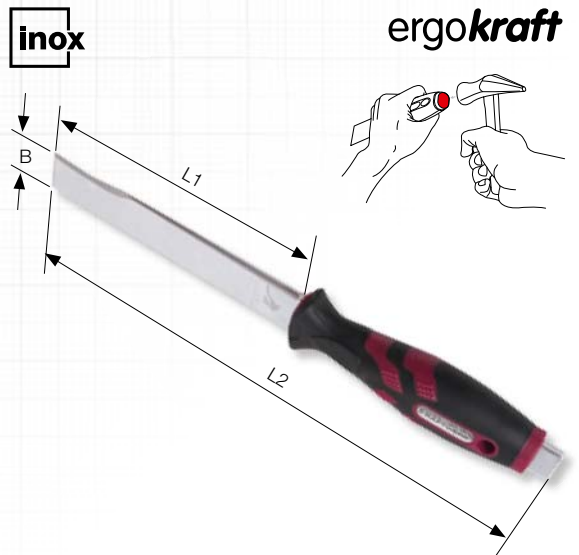

Offset body seam splitter

with 2-component handle

Palanqueta acodada para carroceria

con mango bimatèrial

Ferramenta de chapeiro curva

cabos em bimatèria anti-derrapante

Art.	B mm	L1 mm	L2 mm	∠
3334-02	24	15	298	30°

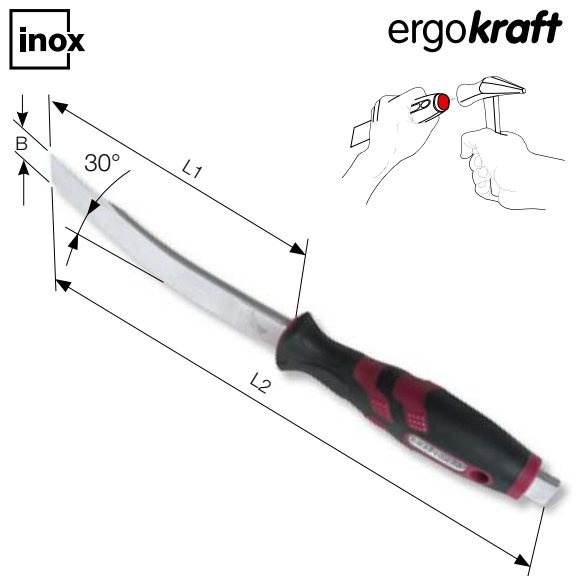

Offset body seam splitter

with 2-component handle

Palanqueta acodada para carroceria

con mango bimatèrial

Ferramenta de chapeiro curva

cabos em bimatèria anti-derrapante

Art.	B mm	L1 mm	L2 mm	L3 mm	∠
3334-03	24	65	95	243	90°

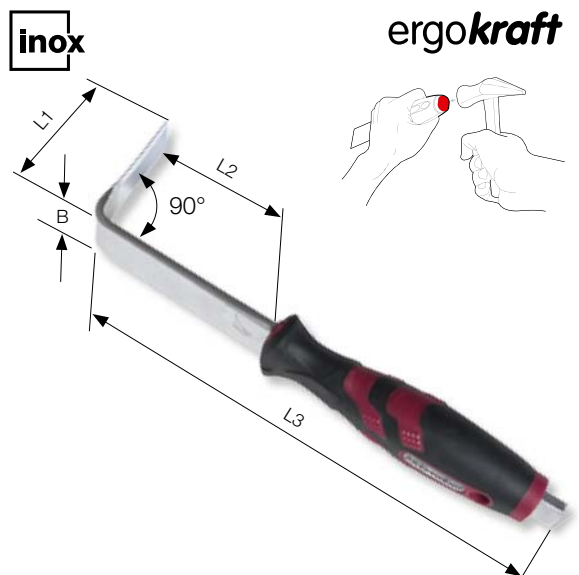

Air die grinder

Lightweight and compact construction with ergonomic handle, cold insulating and low in vibration. Adjustable rear air outlet (prevents from raising dust). Safety lever and variable speed regulation. Ideal for grinding, deburring, milling and engraving.

Amoladora neumática

Construcción ligera y compacta con mango ergonómico, aísla la mano de las vibraciones y del frío. Salida de aire ajustable en la parte trasera (limita la dispersión de polvo). Palanca de seguridad y ajuste de velocidad. La herramienta ideal para rectificar, desbarbar, fresar y grabar.

Rectificadora pneumática

Construção leve e compacta com pega ergonómica, insonorizada e baixa vibração. Escape de ar ajustável (evita criação de poeiras). Nivelador de segurança e regulação de velocidade. A ferramenta ideal para moer, rebarbar, fresar e gravar.

Mini air die grinder set

with 2 collet chucks 3 mm and 6 mm and 5 grinding stones of 3 mm / 6 mm each

Estuche de mini amoladora recta neumática

con 2 pinzas de 3 mm y 6 mm y 5 muelas abrasivas de 3 mm / 6 mm cada una

Mini rectificadora pneumática

com 2 mandris de 3 e 6 mm e 5 pedras de moagem de 3 e 6 mm cada



Art. 3840



15
PCS



250 × 185 × 60 mm

Art.

3840K

Mini air die grinder

Mini amoladora recta neumática

Mini rectificadora pneumática

6 mm 3 mm	25000	0.4	80	155
1/4"	3/8" (10 mm)	2.6 (CFM)	90	

Art.	L mm	kg
3840	155	0.4



L

Air die grinder
Amoladora recta neumática
Rectificadora neumática

6 mm 3 mm	22000	0.6	80	180
1/4"	3/8" (10 mm)	3.5 (CFM)	90	

Art.	L mm	kg
3841	180	0.6



Air angle die grinder
Amoladora angular neumática
Rectificadora neumática angular

6 mm 3 mm	18000	0.7	86	180
1/4"	3/8" (10 mm)	3.5 (CFM)	90	

Art.	L mm	kg
3842	180	0.7



Carbide spot weld drill bit
8 mm, TiAIN.

Broca para puntos de soldadura
8 mm, en metal duro, TiAIN.

Broca para descravar
8 mm, em metal duro, TiAIN.

VHM **TiAIN**



Art.	Ø mm	L mm
18080	8	80



Antifreeze and battery acid refractometer



with AdBlue concentration tester

Refractómetro para antigel y ácido de batería

con control de concentración AdBlue

Refratómetro para anti-congelante e ácido de batería

com controlo da concentração AdBlue

Art.		Spec.
31125	Ethylene Glycol	-25 ~ -50 °C
	Propylene Glycol	-25 ~ -50 °C
		1.10 - 1.30 kg/l
	AdBlue®	30% - 35%
		-10 ~ -40 °C

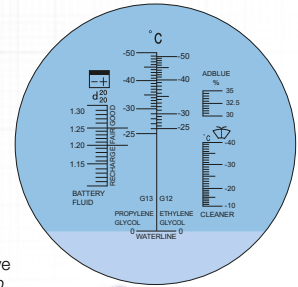

Anti-freeze tester for ethylene glycol

Densímetro para líquidos anticongelantes a base de glicol etílico

Densímetro para líquido anti-congelante a base de glicol etílico

Art.	°F	°C	
31101	+25	-7	●
	+5	-15	● ●
	-10	-23	● ● ●
	-25	-31	● ● ● ●
	-34	-37	● ● ● ● ●
			● ● ● ● ● ●



Anti-freeze tester for propylene glycol

Densímetro para líquidos anticongelantes a base de glicol propilénico

Densímetro para líquido anti-congelante a base de glicol propilénico

Art.	°F	°C	
31102	+20	-7	●
	+10	-12	● ●
	-5	-21	● ● ●
	-26	-32	● ● ● ●
	-50	 -46	● ● ● ● ●



Battery acid tester

with float

Densímetro de líquido de la batería

con flotadores

Densímetro para líquido de baterías

com flutuador



Art.	1.145 - 1.260 g/ml	
31103	Discharged / Descargada / Descarregada	○
	> 25 % 1.145	●
	> 50 % 1.186	● ●
	> 75 % 1.222	● ● ●
	1.260	● ● ● ●
	⚠ 80° F	

Brush cleaner for battery posts and terminals

for the removal of corrosion and dirt on battery poles and pole terminals

Cepillo para limpieza de bornes y terminales de batería

para una fácil eliminación de suciedad y corrosión

Escova de Limpeza para bornes e terminais de bateria

para remoção da corrosão e sujidade dos polos da bateria e dos terminais

Art.
31308



↕ L 80 mm, Ø 40 mm

Battery alternator tester

with LED for quickly and easily indication of the battery's condition and alternator's output

Comprobador batería y alternador

con pantalla LED para una rápida comprobación del estado de la batería y del alternador

Verificador de bateria e alternador

com LED para indicação rápida e fácil da condição da bateria e do estado do alternador

Art.		
31129	weak/débil/débil	●
	sufficient/suficiente/suficiente	● ●
	good/bueno/bem	●
	low/bajo/baixo	● ●
	normal/normal/normal	●
	high/alto/alto	● ●



110 mm



Battery disconnect switch

- easily disconnect from a power supply
- prevent the battery from discharge during longer immobilisation time
- the knob can be removed to prevent theft
- ideal for vehicles that are being stored for extended periods of time

Desconectador rápido de batería

- fácil desconexión de la corriente en el circuito eléctrico del vehículo con un simple giro a la rueda
- protege la batería durante un largo tiempo
- ideal para hibernación de automóviles
- funciona como un antirrobo si se quita la rueda completamente

Terminal de desconexão rápida de bateria

- desliga rapidamente da fonte de alimentação
- evita a descarga da bateria durante imobilização prolongada
- encaixe removível para evitar roubo
- ideal para veículos que estão armazenados durante longos períodos de tempo

Art.	L mm
31309	85



Voltage tester

Comprobador de tensión

Verificador de tensão

Art.	⊖ ⊕	L mm
31127	3-48 V	145



Battery disconnect switch

for preservation of memory when changing the vehicle's battery

Cable salva-memorias OBD

evita la pérdida de datos en el sistema electrónico cuando se desconecta la batería

Terminal de desconexão rápida de bateria

para preservar a memória durante a substituição da bateria do veículo



OBDII 12 V

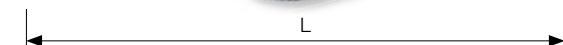

Art.	L m
31128	3.6

Air conditioner gauge

for testing the refrigerant fluid level at the low pressure service port of an air conditioning system on a vehicle

Comprobador presión aire acondicionado

para la comprobación del nivel de líquido refrigerante a través de la conexión de baja presión del circuito de aire acondicionado

Manómetro de ar condicionado

para testar o nível de líquido refrigerante na válvula de baixa pressão do sistema de ar condicionado do veículo



Art.		
31131	too low/demasiado bajo/ demasiado baixo	●
	okay/correcto/correto	●
	too high/demasiado elevado/ demasiado elevado	●
	danger/peligro/perigo	●

7-13 pin trailer tester

for a quick check of the vehicle's and trailer's lighting system and wiring

Comprobador conexiones de remolque 7-13

para una rápida comprobación de instalaciones de 7 y 13 polos

Testa ligações atrelado 7/13 pin

para uma verificação rápida do sistema de iluminação do veículo e do atrelado e da cablagem



Art.
31133

ISO 1724

Cylinder pressure leak tester detector and crank stopper

- to check the tightness of diesel or petrol engine cylinders
- incl. gauge
- incl. various adapters
- maximum pressure 6.8 bar

Detector de fugas de cilindros

- para comprobar la estanqueidad de los cilindros de motores diesel y gasolina
- incl. manómetro
- incl. varios adaptadores
- presión máxima 6.8 bar

Kit testa fugas de cilindros

- para verificar o aperto dos cilindros a diesel ou o motor a gasolina
- inclui manómetro
- inclui vários adaptadores
- pressão máxima de 6.8 bar

Art.	max. bar	L
31108	0-7 bar 0-100 psi	66 cm



✚ 375 x 290 x 70 mm

Flow meter, set

- for Common-Rail injectors
- quick and effective measure of the fuel flowing back
- determination of damaged nozzles
- simultaneous measurement of up to 6 injectors
- without disassembling of the injectors

Conjunto medidor de flujo de common rail

- para inyectores common-rail
- medición rápida y eficaz del flujo de retorno
- determinación del inyector dañado
- medición simultánea de hasta 6 inyectores
- sin desmontar inyectores

Conjunto medidores de retorno

- para inyectores common-rail
- medida rápida e eficaz do retorno do combustível
- determinação de bicos danificados
- medição simultânea de até 6 inyectores
- sem desmontagem dos inyectores



450 × 315 × 58 mm



Art.

31111

Bosch, Delphi, Denso, Siemens



Info

KRAFTWERKtools.com/info/31111

Digital compression test kit

- for petrol engines
- for dry and wet compression tests
- compact fittings with quick coupling
- digital gauge with data logger for up to 12 cylinders
- repair of the valve seals possible without removing the cylinder head
- flexible hose for hard to reach places

Comprobador de compresión digital

- para motores de gasolina
- test de compresión en seco y húmedo
- conexiones compactas, con acoplamiento rápido
- indicador digital con registro de datos de hasta 12 cilindros
- comprobación de estanqueidad de la junta sin desmontar la culata
- manguera flexible para espacios difíciles

Kit testa compressão digital

- para motores a gasolina
- para os ensaios de compressão de secos e molhados
- manómetro digital com registo de dados até 12 cilindros
- possível reparar as juntas das válvulas sem remover a cabeça do cilindro
- mangueira flexível para locais de difícil acesso

2.09
digital

PSI/BAR/kPA



372 × 290 × 65 mm



Art.

31107

Acura, Audi, BMW, Chrysler, Daihatsu, Ford, GM, Honda, Infiniti, Isuzu, Jaguar, Jeep, Kia, Land Rover, Lexus, Mazda, Mercedes, Mitsubishi, Nissan, Peugeot, Porsche, Saturn, Subaru, Suzuki, Toyota, Volvo, VW

Compression test set

- for petrol engines
- compression test up to 50 bar (725 psi) possible
- quick couplings in straight and angled versions
- suitable for most car, truck, bus, agricultural and marine engines

Comprobador de compresión para gasolina

- para motores de gasolina
- comprobación posible hasta 50 bar (725 psi)
- racor rápido recto y angular
- apropiado para la mayoría de coches, camion, autobús, etc

Teste de compressão

- para motores a gasolina
- compressão possível até 50 bar (725 psi) possível
- engates rápidos nas versões retas e angulares
- adequado para a maioria dos carros, camiões, autocarros, motores agrícolas e marinhos

Art.	 max. bar	Pos.	Ø
31109	0-20 bar 0-290 psi	1	M10
		2	M12
		3	M18
		4	M14
		5	M14
		6	M14 + M18
		7	M10 + M12



↕ 373 × 290 × 67 mm

Compression tester



- for diesel engines
- universal adapters for glow plugs and injectors

Comprobador de compresión

- para motores Diesel
- adaptadores universales para calentadores e inyectores

Teste de compressão

- para motores a diesel
- adaptadores universais para velas e inyectores

Art.	 max. bar	
31106	0-70 kg/cm ² 0-1000 psi	Audi, Bacharach, BMW, Caterpillar, Cummins, Detroit Diesel, Ford, General Motors, Hummer, Isuzu, John Deere, Mercedes, Peugeot, Toyota, Volvo, VW



↕ 590 × 260 × 61 mm

Compression tester

- for diesel engines
- universal adapters for glow plugs and injectors

Comprobador de compresión

- para motores Diesel
- adaptadores universales para calentadores e inyectores

Teste de compressão

- para motores a diesel
- adaptadores universais para velas e inyectores

Art.	max. bar
31110	0-70 kg/cm ² 0-1000 psi

BMW, Citroën, Dacia, Daihatsu, Fiat, Ford, Holden, Isuzu, Land Rover, Leyland, Mazda, Mercedes, Mitsubishi, Nissan, Opel, Peugeot, Renault, Rover, Seat, Toyota, Volvo, VW

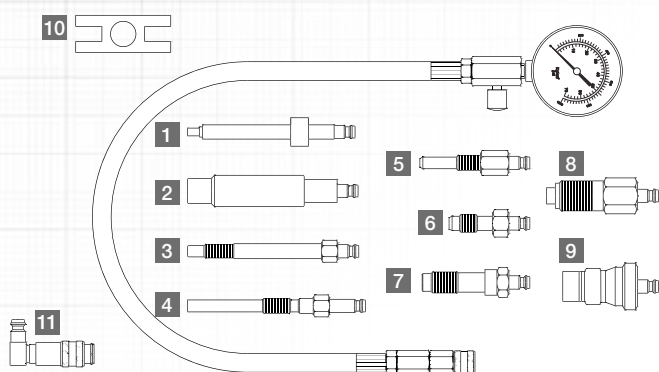

372 × 290 × 65 mm

Pos.		Ø mm
1		19
2		21
3	M10 × 1.25	
4	M10 × 1.0	
5	M10 × 1.25	
6	M12 × 1.25	
7	M14 × 1.25	
8	M20 × 1.25	
9	M24 × 2.0	
10	63.5 × 25	17
11	90°	

Compression tester

- for diesel engines
- universal adapters for glow plugs and injectors

Comprobador de compresión

- para motores Diesel
- adaptadores universales para calentadores e inyectores

Teste de compressão

- para motores a diesel
- adaptadores universais para velas e inyectores

Art.	max. bar
31112	0-70 kg/cm ² 0-1000 psi

Alpha Romeo, BMW, Chrysler, Citroën, Fiat, Ford, Hyundai, Isuzu, Mazda, Mercedes, Mitsubishi, Nissan, Opel, Peugeot, Renault, Rover, Saab, Suzuki, Toyota, Volvo, VW



410 × 328 × 103 mm

Test and calibrating device

for diesel injectors

Comprobador de inyector Diesel

para inyector diesel

Teste de injectores

para injectores a diesel

Art.	 max. bar
31114	0-600 bar 0-8700 lbs



✚ 455 × 295 × 153 mm

CO₂ Cylinder leakage test kit

- to locate leaks on internal combustion engines
- to detect CO₂ in the cooling liquid
- ideal for use on cylinder heads, cylinder head gaskets and engine blocks
- leakage by discoloration of the test liquid visible
- for all common vehicles with water-cooled engines (gas, diesel and petrol)
- self-regenerating reaction liquid for multiple use

Detector de fugas de CO₂ en los sistemas de refrigeración

- para localizar fugas en motores de combustión interna
- para detectar CO₂ en líquido de refrigeración
- Ideal para comprobar las fugas en la junta de culata y bloque de motor
- detectable por decoloración visible del líquido
- para vehículos por refrigeración líquida (gas, diesel y gasolina)
- líquido reutilizable

Kit para teste de fugas de CO₂

- para localizar fugas em motores de combustão interna
- para a detecção de CO₂ no líquido de arrefecimento
- ideal no uso de cabeçotes, juntas de cabeçotes e blocos de motor
- Detectável pela descoloração visível do líquido
- para todos os veículos comuns com motores refrigerados a água (gás, diesel e gasolina)
- Líquido de reação auto-regeneração de uso múltiplo

Art.	
31115	250 ml



✚ 350 × 243 × 88 mm



Oil pressure tester

- for diagnosis of leaks in the oil system
- scale of 0-10 bar (tolerance + -5%)

Comprobador de la presión de aceite

- para diagnóstico y fugas en el circuito de aceite
- escala 0-10 bar (tolerancia + -5%)

Kit pressão de óleo

- para o diagnóstico de fugas no sistema de óleo
- escala de 0-10 bar (tolerância + -5%)



373 × 290 × 64 mm

Art.	max. bar
31116	0-10 bar 0-140 psi

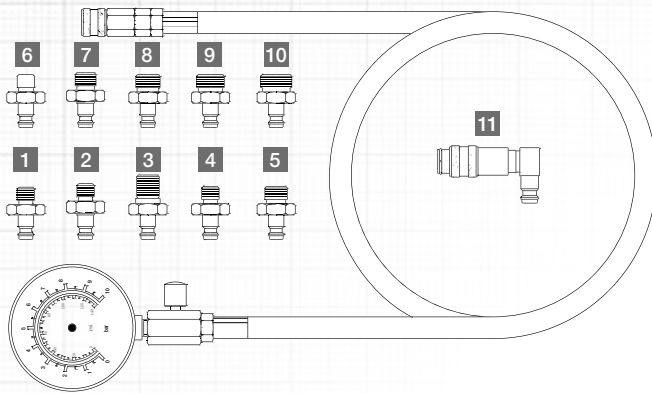

Pos.	
1	R1/8 DIN 2999
2	1/8-27 NPT
3	1/4-18NPT
4	3/8-20UNF
5	1/2-20UNF
6	M10 × 1.0
7	M12 × 1.5
8	M14 × 1.5
9	M16 × 1.5
10	M18 × 1.5
11	90°



Electronic stethoscope

- facilitates the localization of noise sources and reduces diagnosis time
- the one-way amplifier enables fast and easy acoustic testing, e.g. alternator and other components of the engine
- includes 6-way amplifier and 6 color-coded probes
- allows trouble shooting while driving at various test points
- with alligator clips for easy, acoustically-coupled mounting on the testing
- for mounting on engine, transmission or axle parts
- headphones with padded headband and earcups provide a comfortable fit

Estetoscopio electrónico

- facilita la localización de la fuente de ruido y reduce el tiempo de diagnosis
- el amplificador de un solo sentido permite la prueba acústica rápida y fácil, por ejemplo, en el alternador y otros componentes del motor
- incluye amplificador de 6 vías y 6 cables con código de color
- permite la resolución de problemas comprobando en distintos puntos
- con pinzas de cocodrilo para un fácil acoplamiento
- para colocar sobre piezas del motor, transmisión o eje
- auriculares con banda de sujeción acolchada y regulador de posición

Estetoscópio electrónico

- facilita a localização de fontes de ruído e reduz o tempo de diagnóstico
- o amplificador de sentido único permite o teste acústico fácil e rápido, por exemplo, em alternador e outros
- inclui amplificador de 6 vias e 6 sondas de código de cores
- permite a resolução de problemas durante a condução em vários pontos de teste
- com pinças de crocodilo para um fácil acoplamento acústico na montagem do teste
- para montagem em motor, transmissão ou partes do eixo
- auscultadores com alça acolchoada e auriculares com um ajuste confortável



Pos. 1-6



377 × 378 × 139 mm

Art.			
31119	6x		4.8 m
	2x		9 V

Stethoscope

to locate noises in engines, transmissions, gears, bearings, etc.

Estetoscopio

para localizar ruidos en motor, transmisión, engranajes, rodamientos etc.

Estetoscópio

para localizar ruídos em motores, transmissões, engrenagens, rolamentos, etc.



Art.
31120

Digital pistol type infrared thermometer

- for contact free temperature measure with laser on surfaces
- time for measure indication: 1 second
- display of the actual and maximum temperature
- LCD-background lighting
- display switchable from °C to °F

Termómetro digital con infrarrojos

- para medir la temperatura con laser indicador de superficie
- tiempo de medición : 1 segundo
- pantalla con temperatura actual y máxima
- pantalla LCD-iluminada
- botón de cambio °C a °F

Termômetro digital infravermelhos

- para medir a temperatura na superfície sem contacto, com o laser em superfícies
- tempo para indicação da medida: 1 segundo
- indicação da temperatura real e máxima
- iluminação LCD-fundo
- indicação selecionável de °C para °F

Art.	°C	°F
31124	-38 ~ +365	-36.4 ~ 689



D:S = 8:1

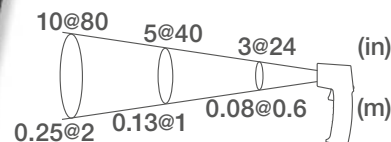

↕ 173 × 36 × 72 mm

Inspection lamp

- with 16 lateral LED and 9 additional UV LED in the front of the lamp
- lightweight and compact aluminium housing with suspension hook
- incl. 3 x AAA alkaline batteries

Lámpara de inspección

- con 16 LED laterales y 9 LED con UV frontales
- carcasa ligera y compacta en aluminio con gancho incorporado
- incluye 3 pilas alcalinas AAA

Gambiarra de inspeccção

- com 16 LED laterais e 9 UV LED na frente
- corpo em alumínio leve e compacto com gancho posicionador
- inclui 3 pilhas AAA

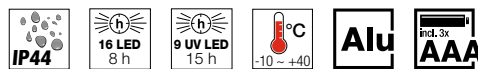

16 LED
150 LUX
75 lm



Art.	
32011UV	16 (150 LUX) + 9 UV

↕ L 224 mm, Ø 28 mm

Photo-/video-endoscope case
Estuche foto-/video-endoscopio
 Mala video-endoscópio

COMPLETO

Art.	Ø mm	L	
4900-45K-0391	3.9	1 m	flex
4900-45K-0393	3.9	3 m	flex
4900-45K-0550*	5.5	1 m	mem
4900-45K-0551*	5.5	1 m	flex
4900-45K-0553*	5.5	3 m	flex
4900-45K-0800	8.0	1 m	mem
4900-45K-0801	8.0	1 m	flex
4900-45K-1200	12.0	1 m	mem
4900-45B	without case / <i>sin maletín</i> / sem caixa		



421 × 200 × 68 mm

Display 3.5" / 89 mm TFT
 640 × 480 pixel
 16.7 Mio. Colors / 30 bps

Video PAL / NTSC

Sensor CMOS

Batterie Li-Polymer-Akku 3.7 V 2000 mAh
 (100~240 V / 50-60 Hz)

Memory SD Card 2GB (max. 8GB)
 IP67

flex: flexible
flexible
 flexível

mem: semi-rigid
semi-rígido
 semi-rígido

* Longer cable on request
 * *Cable mas largo a petición*
 * Cabo mais longo a pedido

inclusive / *incluido* / *incluído*



L1 94 × L2 78 × L3 10 mm

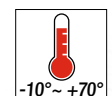
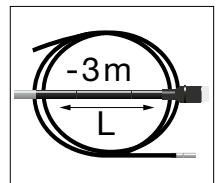
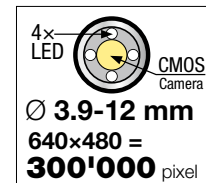
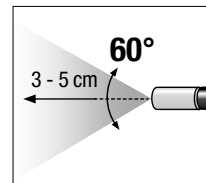

Optional / *Opcional* / *Opcional* :
 4900-45K-0550 / 4900-45K-0551 / 4900-45K-0553

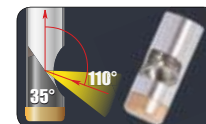

Art. 4900-45-02

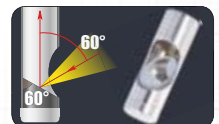

Art. 4900-45-03



OBD-II Tester

- suitable for vehicles from 1996 onwards with OBD-II interface
- easy reading out and deleting engine fault
- does support the CAN, VPW, PMW, ISO and KWP 2000 protocols

Comprobador OBD-II

- herramienta de diagnosis para vehículos compatibles con OBD-II producidos después de 1996
- fácil lectura y borrado de los códigos de avería (DTC)
- soporta los protocolos CAN, VPW, PMW, ISO y KWP 2000

Ferramenta de Teste OBD-II

- compatível com veículos a partir de 1996 com interface OBD-II
- leitura fácil e eliminação dos erros de motor
- compatível com protocolo CAN, VPW, PMW, ISSO e KWP 2000



± 126 x 78 x 28 mm

Art.

31126



Digital multimeter

- more than 10 functions
- Display lighting
- Temperature range -55°C ~ 1'000°C
- Hold function

Polímetro digital

- con más de 10 funciones
- pantalla con retroiluminación
- temperatura de medición -55°C a 1'000°C
- con función Data Hold

Multímetro digital

- Mais de 10 funções
- Ecrã retroiluminado
- Medição de temperatura de -55°C a 1000°C
- Função hold



± 178 x 85 x 40 mm

CAT. II 1000 V CAT. III 600 V

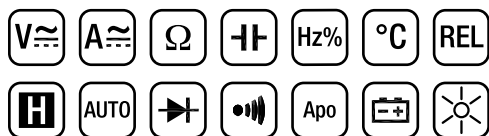

Art.

31130



Info
KRAFTWERKtools.com/info/31130

Brake fluid tester

electronic, for testing the percentage of water in brake fluid

Comprobador líquido freno

electrónico, para determinar el contenido de agua en el fluido de freno

Testa líquido de travões

electronica, para determinar o teor de água no fluido do travões



↕ 150 x 18 x 20 mm

	💧	
⚠	<3%	>4%
ok	<1%	2%
batt	0%	

Art.
31104

Coating thickness gauge

for the fast and non-destructive coating thickness measurements. Battery included.

Medidor espesor de pintura

para la medición rápida y sin daños del grosor de la capa de pintura. Batería incluida.

Comprovador de pintura/verniz

para uma medição rápida e não destrutiva da camada de verniz. Bateria incluída.



↕ 68 x 40 x 14 mm

Art.		
31132	1 mm	●
	1 mm - 1.8 mm	●
	1.8 mm	●

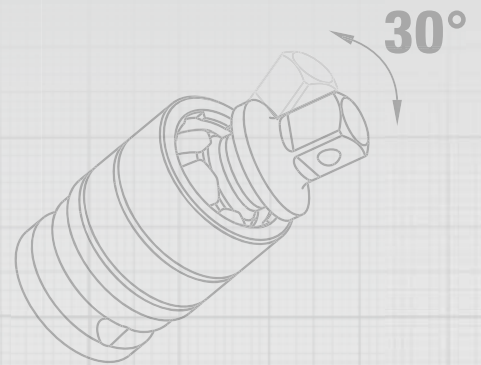
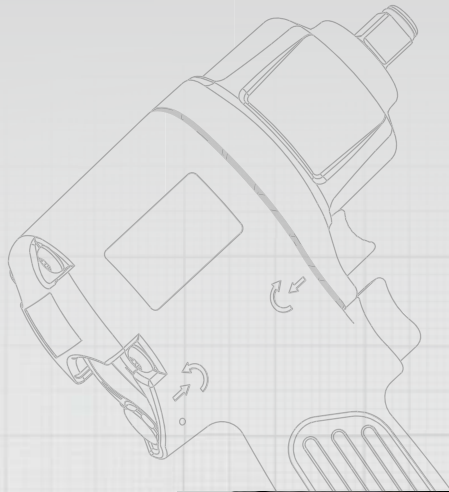

6

Electric tools
Herramientas eléctricas
Ferramenta de elétrico

Professional universal start booster

portable, in shockproof ABS housing, with fully isolated brass clamps, extra long cable 228 cm, with sealed non-spillable battery, including cable with adapter for cigarette lighter plug. Protected against voltage peaks, with audible and visual alarm. Automatic charger. Even vehicles with totally discharged batteries can be started!

Arrancador de batería profesional y universal

portátil, carcasa de ABS resistente, pinzas aisladas de latón, cable largo extra 228 cm, con batería plomo antigas, incluye cable con adaptador para el encendedor del coche. Protegido contra picos de voltaje con alarma acústica y visual. Cargador automático. ¡Incluso se pueden arrancar los vehículos con la batería totalmente descargada!

Booster de bateria profissional e universal

portátil, corpo em ABS resistente. Pinças em latão. Cabo extra longo 228 cm. Com bateria. Inclui cabo com adaptador para carregamento no isqueiro do veículo. Protecção contra picos de tensão, com alarme visual e sonoro. Carregador automático. Com capacidade para arrancar veículos com a bateria totalmente descarregada



345 × 240 × 330 mm

Art.

31306

12-24 V 1900 CA / 5000 A

Professional universal start booster

with trolley, in shockproof ABS housing, with fully isolated brass clamps, extra long cable 200 cm, with sealed non-spillable battery, including cable with adapter for cigarette lighter plug. Protected against voltage peaks, with audible and visual alarm. Automatic charger. Even vehicles with totally discharged batteries can be started!

Arrancador de batería profesional y universal

con carrito, carcasa de ABS resistente, pinzas aisladas de latón, cable largo extra 200 cm, con batería plomo antigas, incluye cable con adaptador para el encendedor del coche. Protegido contra picos de voltaje con alarma acústica y visual. Cargador automático. ¡Incluso se pueden arrancar los vehículos con la batería totalmente descargada!

Booster de bateria profissional e universal

com trolley, portátil, corpo em ABS resistente. Pinças em latão. Cabo extra longo 200 cm. Com bateria. Inclui cabo com adaptador para carregamento no isqueiro do veículo. Protecção contra picos de tensão, com alarme visual e sonoro. Carregador automático. Com capacidade para arrancar veículos com a bateria totalmente descarregada.



345 × 300 × 455 mm

Art.

31307

12-24 V 1900 CA / 5000 A

Professional start booster

portable, in shockproof ABS housing, with fully isolated brass clamps, extra long cable 160 cm, with sealed non-spillable battery, including cable with adapter for cigarette lighter plug.

Arrancador booster de batería profesional

portátil, carcasa de ABS resistente, pinzas aisladas de latón, cable largo extra 160 cm, con batería plomo antigas, incluye cable con adaptador para el encendedor del coche.

Booster de bateria profissional

portátil, corpo em ABS resistente. Pinças em latão. Cabo extra longo 160 cm. Com bateria. Inclui cabo com adaptador para carregamento no isqueiro do veículo.



↕ 350 × 170 × 330 mm

Art.
31305 12 V 950 CA / 2500 A

	Art. 31306	Art. 31307	Art. 31305
	portable portátil portátil	with Trolley con carrito com trolley	portable portátil portátil
Voltage / Voltaje / Voltagem	12-24 V	12-24 V	12 V
Boost rate / Amperaje arranque / Descarga máxima	5000 / 2500 A	5000 / 2500 A	2500 A
Cranking rate / Amperaje continuo / Descarga de arranque	1900 A	1900 A	950 A
Battery capacity / Capacidad de la batería / Capacidade da bateria	2x 12 V 24 Ah	2x 12 V 24 Ah	12 V 24 Ah
Recharge / Recarga / Voltagem de carga	230 V 50 Hz	230 V 50 Hz	230 V 50 Hz
Charging capacity / Capacidad de carga / Capacidade de carga	12 V 4 Ah	12 V 4 Ah	12 V 1,5 Ah
Charging voltage / Voltaje de carga / Tensão de carga	max. 14,9 V/25,2 V	max. 14,9 V/25,2 V	max. 14,9 V
Life of battery (cycles) / Duración (ciclo) / Ciclos de carga	400-500	400-500	400-500
Cable diameter / Diámetro de cable / Diámetro dos cabos	50 mm ²	50 mm ²	25 mm ²
Length of cables / Longitud de cable / Comprimento dos cabos	228 cm	200 cm	160 cm
Number of batteries / Número de baterías / Número de baterias	2	2	1
Weight (without charger) / Peso (sin cargador) / Peso (sem carregador)	20,7 kg	23,3 kg	10,1 kg

Radio removal tool set

for the removal of car radios and navigation devices

Kit llaves para desmontar radio

para desmontar radios y sistemas de navegación

Kit de chaves para desmontar rádio

para a remoção de auto-rádios e sistemas de navegação

Art.	
31301	BECKER: Audi, BMW, Ford, Mercedes, Porsche, VW BLAUPUNKT New: BMW, Škoda New, Opel, VW BLAUPUNKT, GRUNDIG



↕ 305 × 100 × 10 mm

Cable / connector terminal set

- assembled for VAG contacts
- universal for automotive electrical applications
- professional and non-destructive release of contacts
- guards for optimum protection of the blades

Conjunto para conectores eléctricos

- para contactos VAG
- uso universal para aplicaciones eléctricas
- para soltar contactos de forma profesional, sin dañarlos
- funda para protección óptima de las hojas

Kit de ferramentas para terminais

- reunidos para contactos VAG
- uso universal para as aplicações eléctricas
- libertação de contactos profissional e indestrutível
- protetores para uma óptima protecção das lâminas

12
PCS



↕ 270 × 215 × 62 mm

Art.
31303





Info
[KRAFTWERKtools.com/info/31303](https://www.kraftwerktools.com/info/31303)



Mini combination crimping pliers
Mini alicate para engastar y pelacable
Mini alicate de cravar e descarnar



Art.		
3253	1.5-6 mm ²	1.5-6 mm ²



50C HRC 44-50

↕ L: 180 mm





1.5-2.5-6.0 mm²

1.5-2.5-6.0 mm²

0.75-5.5 mm²

0.75-0.9-1.25-2-3.5 mm²

Crimping pliers
Alicate para engastar terminales
Alicate de cravar terminais

Art.	 mm ²	 mm ²	L mm
2225	1.5 - 6	1.5 - 4.6	240



5-in-1 crimping and wire stripping pliers
GS-approved, hardened and with ground edges for professional and industrial use



Alicate para engastar con pelacables "5 en 1" aprobado GS, endurecido y con bordes redondeados para su uso profesional e industrial

Alicate 5-em-1 cravar e descarnar
aprovação GS, endurecido para uso profissional e industrial

ergokraft



"K5" HRC 54

Art.	 mm ²	 mm ²	L mm
3290-230	1.5 - 6	1.5 - 4.6	230



M2.6-M3.5-M4-M5

Bolt cutter
Para pernos
Corta parafusos



1.5-2.5-6.0 mm²

Crimping pliers for insulated terminals
Alicate para engastar terminales no aislados
Crava terminais isolados

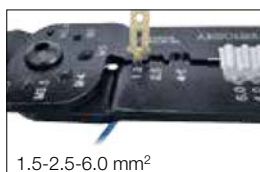

1.5-2.5-6.0 mm²

Crimping pliers for open barrel terminals
Engastar terminales abiertos
Crava terminais abertos



1.5-2.5-4.6 mm²

Wire cutter
Corta cable
Corta Fios



0.75-1.0-1.5 mm²
2.5-4.0-6.0 mm²

Wire Stripper for cables
Pelacable para
Descarnador de fios

Ratchet lever crimping pliers case

with interchangeable jaws including crimping jaws for insulated terminals and closed, non insulated terminals and non insulated ferrules. Empty compartments for supplementary jaws or to store terminals.

Estuche de alicates de carraca para engastar terminales

con cabezales intercambiables para terminales de cables aislados y terminales de cables sin aislar. Compartimentos vacíos para los cabezales suplementarios y depósito de terminales.

Alicate de roquete para cravar terminais em Estojo

com cabeças intermutáveis incluindo para terminais isolados e terminais não-isolados. Compartimentos vazios para cabeças suplementares.

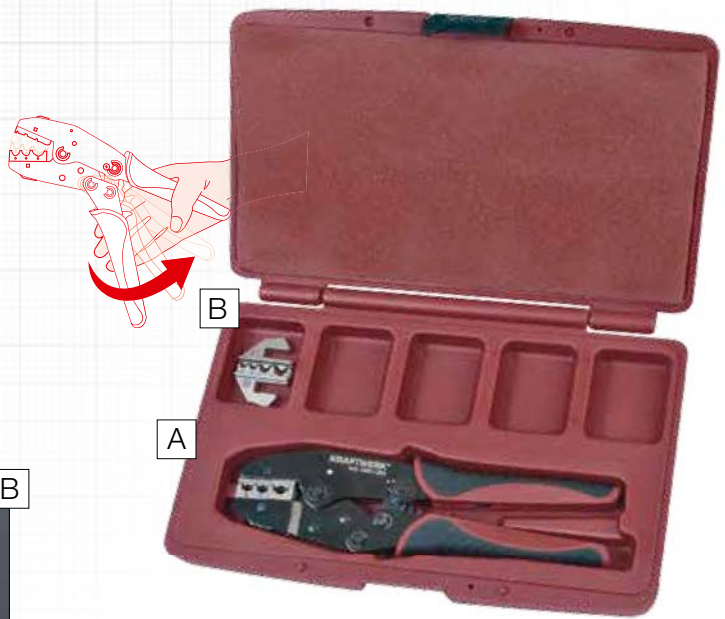

DIN 0.5-1.0 / 1.5-2.5 / 4-6 mm²
AWG 20-18 / 16-14 / 12-10



DIN 1.5 / 2.5 / 6 / 10 mm²
AWG 20-18 / 16-14 / 12-10 / 8
JIS 1.25 / 2 / 5.5 / 8 mm²



280 × 150 × 40 mm

Art.	incl. 	L mm
3291	1x 3291-01 1x 3291-02	220

Optional crimp jaws

Bocas opcionales

Cabeças opcionais



Art. 3291-03
DIN 0.5-1.0 / 1.5-2.5 / 4-6 mm²
AWG 20-18 / 16-14 / 12-10



Art. 3291-04
DIN 0.5 / 0.75 / 1.0 / 1.5 / 2.5 / 4.0 mm²
AWG 22 / 20 / 18 / 16 / 14 / 12



Art. 3291-05
Coaxial RG 58.59.62.6.
6.48 / 5.41 / 2.5 / 1.72 / 8.23 mm²
0.255 / 0.213 / 0.1 / 0.68 / 0.324"



Art. 3291-06
DIN 6 / 10 / 16 mm²
AWG 10 / 8 / 6



Art. 3291-07
4P4C / RJ22



Art. 3291-08
6P2C / 6P4C / RJ11
6P6C / RJ12



Art. 3291-09
8P8C / RJ45



Art. 3291-10
DIN 2.5 / 0.5 / 8-10 mm²
AWG 14 / 22 / 8-6

Universal VDE tool case 1000V
Estuche universal de herramientas VDE 1000V
Mala de ferramentas VDE 1000V universais

CrV

S2
quality

6
PCS



	8	2.5 x 75 mm	5.5 x 125 mm
		3.0 x 100 mm	6.5 x 150 mm
		3.5 x 100 mm	8.0 x 175 mm
		4.0 x 100 mm	10.0 x 200 mm

	4	PH0 x 60 mm	PH2 x 100 mm
		PH1 x 80 mm	PH3 x 150 mm

	4	PZ0 x 60 mm	PZ2 x 100 mm
		PZ1 x 80 mm	PZ3 x 150 mm

	12	T6 x 100 mm	T20 x 100 mm
		T7 x 100 mm	T25 x 125 mm
		T8 x 100 mm	T27 x 125 mm
		T9 x 100 mm	T30 x 150 mm
		T10 x 100 mm	T40 x 175 mm
		T15 x 100 mm	T45 x 175 mm

	6	2.5 x 100 mm	5.0 x 150 mm
		3.0 x 100 mm	6.0 x 175 mm
		4.0 x 125 mm	8.0 x 200 mm

		100 - 250V	
---	--	------------	---

		4-5-5.5-6-7-8-9-10-11-12-13-14 mm	
---	--	-----------------------------------	--

↔ 555 x 345 x 215 mm

	Art. 3282-160V	160 mm
--	----------------	--------

	Art. 3281-180V	180 mm
---	----------------	--------

	Art. 3285-200V	200 mm
---	----------------	--------

	Art. 3289-160V	160 mm
---	----------------	--------

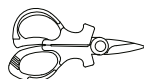
	Art. 2251V	155 mm
---	------------	--------

	Art. 3321V	185 mm
---	------------	--------

	Art. 3321-4V	
---	--------------	--

	8-10-12-13-14-17-19-22 mm	
---	---------------------------	--

	Art. 3210V - 200 mm	
---	---------------------	--

	Art. 207150V - 150 mm	
---	-----------------------	--

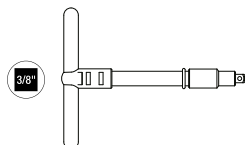
	Art. 212200V - 200 mm	
---	-----------------------	--



Art.	○
4057	3/8"

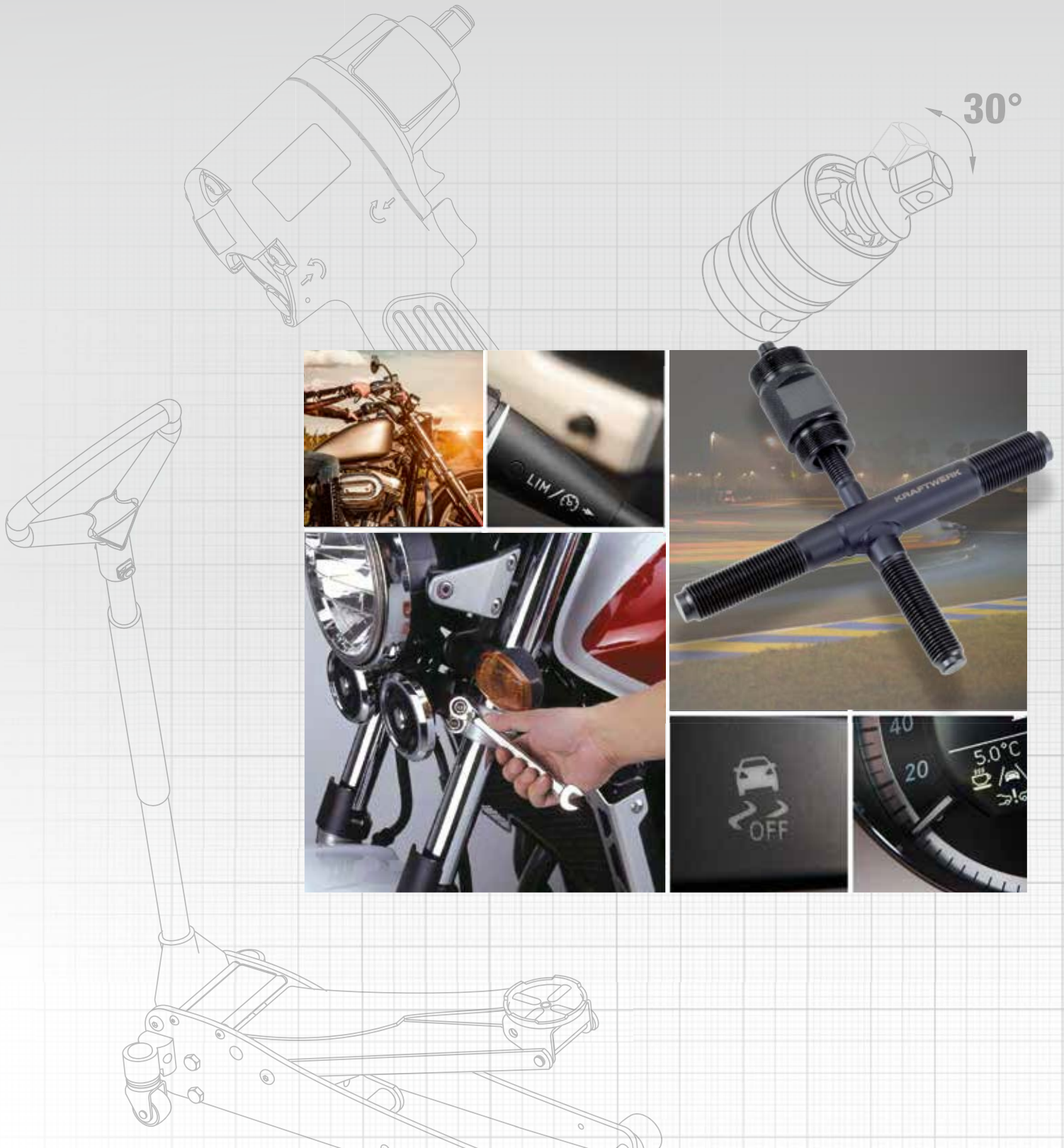

7

Motorcycle tools
Útiles motocicleta
Ferramenta para motos

Chain breaker and riveting tool set

for motorcycle chains

Desmontador y remachador de cadenas

para cadena de motocicletas

Extractor e cravador de corrente

para correntes de motos

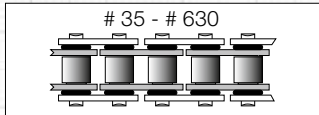

Art.

31601

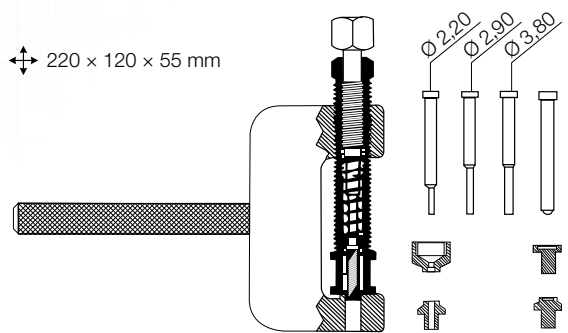

Brake piston resetting tool

Reposicionador frenos

Reposicionador de travões

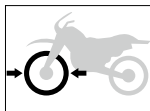

Art. L

31602

1/4" ~ 2.14"
6.4 ~ 58 mm



Axle pin special insert
Llave hexagonal
Chave de 4 medidas



Art.	mm	
31603	17-19-22-24	BMW, Honda, Kawasaki, Suzuki, Yamaha

Inner bearing puller, set
Juego de extractores de rodamientos interiores
Jogo de extractores de rolamentos interiores



Art.	Pos.	
31604	1	5/16" - 13/32" (8 - 10 mm)
	2	13/32" - 15/32" (10 - 12 mm)
	3	15/32" - 9/16" (12 - 14 mm)
	4	19/32" - 11/16" (15 - 17 mm)
	5	11/16" - 25/32" (17 - 20 mm)
	6	25/32" - 15/16" (20 - 24 mm)
	7	1" - 1-1/8" (25 - 29 mm)
	8	1-3/16" - 1-1/4" (30 - 32 mm)

480 x 195 x 57 mm

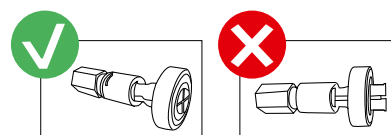

Flywheel puller, set
Kit extractor volante
Kit extractor de volante

Art.		
31605	M28 x 1.5	Cagiva, Ducan, Ducati, Gilera, Honda, Kawasaki, Kimoo, Kokusan, Kymco, MBK, Minarelli, Motoplat, Peugeot, Sfera, Suzuki, Yamaha
	M27 x 1.25 - M20 x 1.0	
	M26 x 1.5 - M22 x 1.5	
	M28 x 1.0 - M26 x 1.0	
	M25 x 1.5 - M22 x 1.0	
	M27 x 1.0L - M24 x 1.0	
	M19 x 1.0	
	M14 x 1.5	
	M16 x 1.5	
	M18 x 1.5	



260 x 160 x 70 mm

Flywheel puller
Extractor volante
Extractor de volante

Art.	
31606	M10 × 1.25R
	M14 × 1.5R
	M16 × 1.5R
	M18 × 1.5R
	M24 × 1.0R
	M27 × 1.0L



Chain brush
Cepillo para cadena
Escova de limpeza para correntes

Art.
31607



Spiral chain brush
Cepillo espiral para cadena
Escova de limpeza espiral para correntes

Art.	Ø mm
31608	55



Automotive

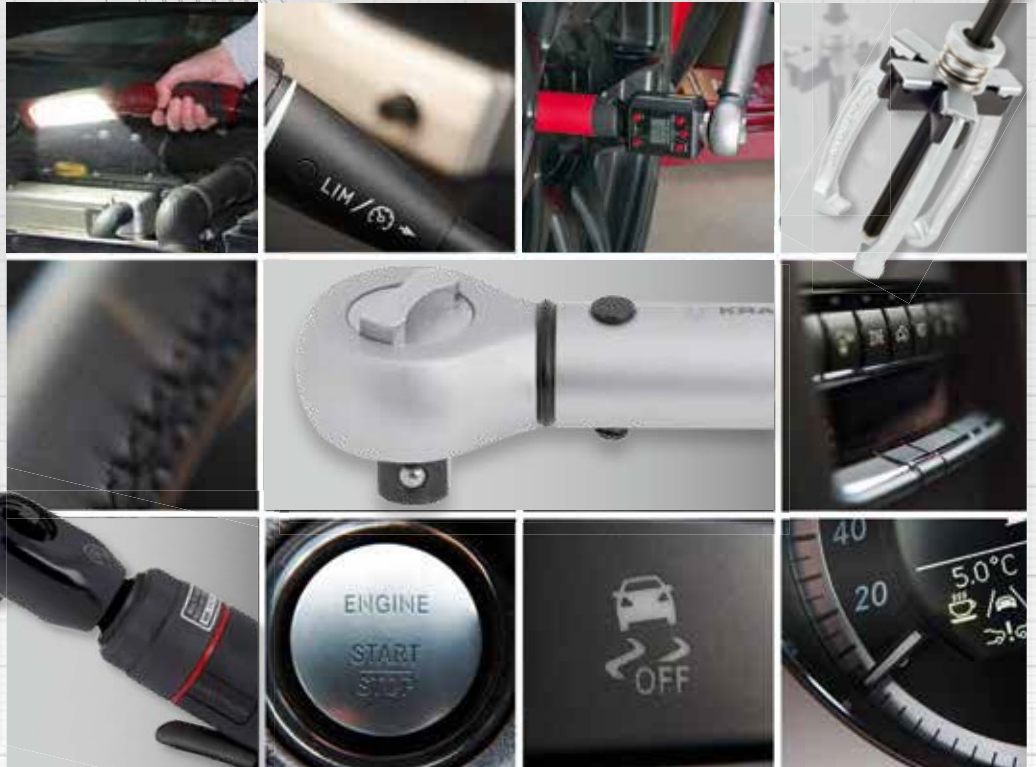
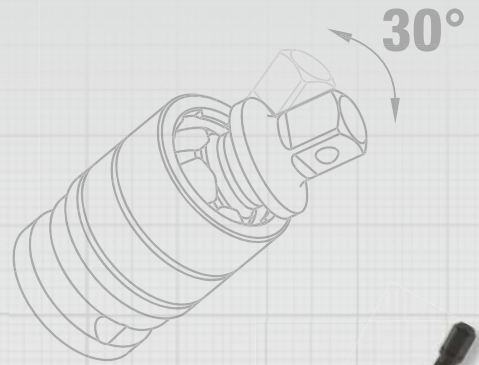
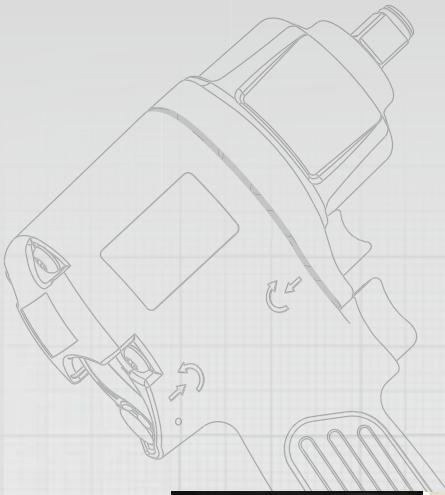

8

General tools
Herramienta general
Ferramenta universal

Universal gear puller

- applicable for inside or outside pulling
- applicable with 2 or 3 arms

Extractor universal

- tomas interior y exterior
- extractor modulable por 2 ó 3 brazos

Extractor universal

- aplicável para interior ou exterior
- aplicável com 2 ou 3 braços

Art.	C min mm	C max mm	H mm	mm
4971-4	76	102	190	17
4971-7	76	178	270	19



4in1



Circlips pliers set

Juego de alicates para arandelas

Jogo de alicates de freios

Art.	content / contiene / contém
2212	2212-A2, 2213-A21, 2214-J2, 2215-J21

4
PCS

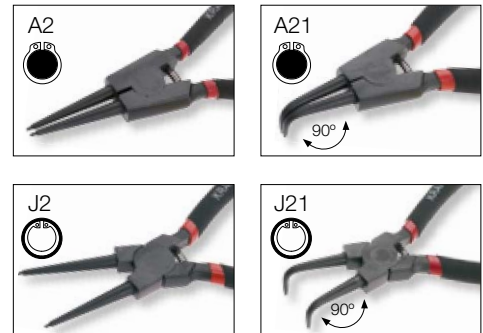

Combined 4-in-1 circlips pliers

for external and internal circlips from 10 to 50 mm, with 4 tip-heads for 180°, 90°, 45° to be changed within seconds, for 6 different applications.

Alicate combinado 4-en-1 para arandelas

exteriores e interiores de 10 a 50 mm con 4 cabezas de puntas de 180°, 90°, 45°. Cambio de cabezas en segundos para 6 usos diferentes.

Alicate combinado 4-em-1 para freios

exteriores e interiores de 10 a 50 mm com 4 cabeças de ponta para 180°, 90°, 45°. Trocando cabeças em segundos para 6 aplicações diferentes.

4
PCS



Art.	Typ / mm	mm	L1 mm
2211	A1-A2, J1-J2 / 10-50 mm	1.35	155

Internal-external circlip pliers

Juego de alicates industriales para aros seger

Conjunto de alicates de freios para trabalhos pesados

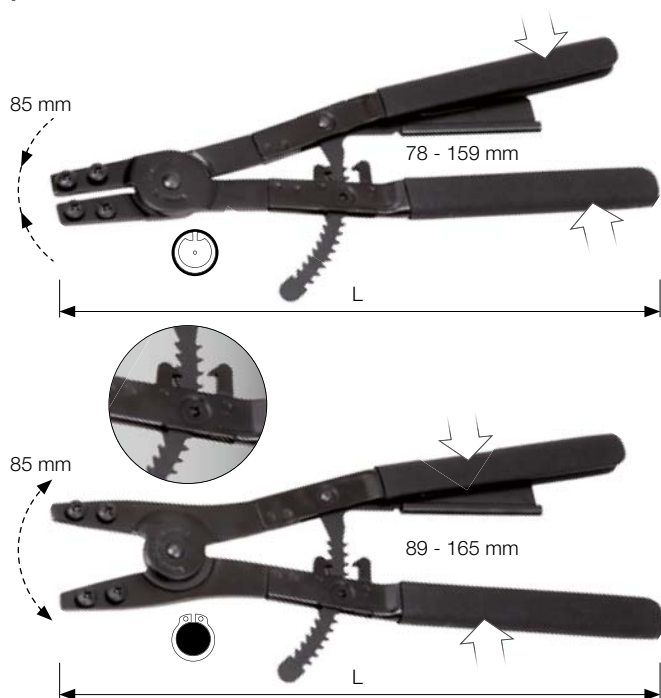

Art.	L mm
30015	400

CrMo **14**
PCS



438 × 334 × 66 mm



Special double X circlips pliers set

2 extra long circlips pliers for internal and external circlips, with 10 pairs of exchangeable tips. Double-X-system for an optimal power transmission.

Juego alicates especiales doble X para arandelas

2 alicates extra largos para arandelas interiores y exteriores, con 10 pares de puntas intercambiables. Sistema doble-X para una óptima transmisión de fuerza.

Conjunto alicates especiais Duplo X para anéis de fixação

2 alicates extra longos para freios interiores e exteriores, com 10 pares de pontas intercambiáveis. Sistema Duplo-X para uma excelente transmissão de força.

Art.	L mm
30006	340

CrV **2**
PCS

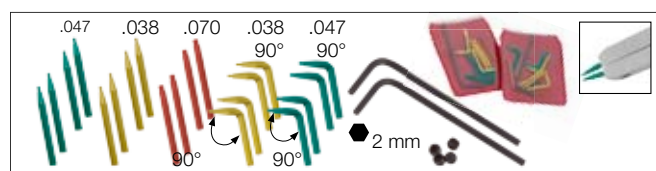
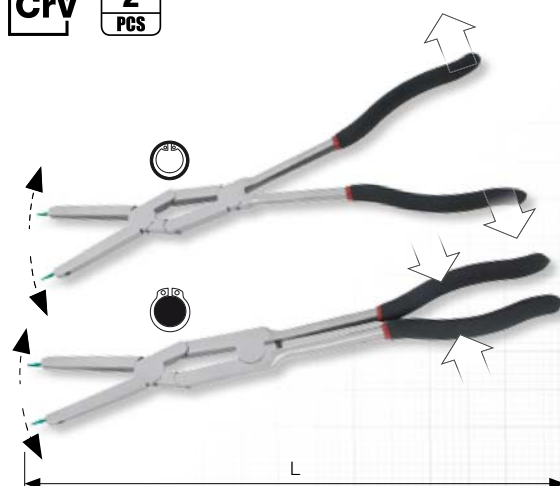

Bulb plier

Alicate para abrazaderas de manguitos

Alicate para lâmpadas

Art.	L1 mm	L2 mm
30013	160	0-34



Special double X pliers set

with 2 extra long nose pliers, straight and 45°.

Double-X-system for an optimal power transmission.

Juego alicates especiales doble X

con 2 alicates de manipulación extra largos, recto y 45°.

Sistema doble-X- para una óptima transmisión de fuerza.

Conjunto de alicates especiais duplo X

com 2 alicates de pontas extra longas, direitas e a 45°.

Sistema Duplo-X para uma excelente transmissão de força.

CrV **2**
PCS



Art.	L mm
30001	330

Nut splitter set

- for the mechanical splitting of faulty or overwound nuts without damaging the thread

- ideal for nuts up to strength category 6

Juego rompetuercas

- para extraer las tuercas sin dañar el espárrago

- ideal para tuercas con categoría de resistencia hasta 6

Conjunto de quebra porcas

- para a separação mecânica de porcas com defeito ou bloqueadas sem danificar o parafuso

- ideal para porcas até a categoria de força 6

Art.	Ø mm	L1 mm	L2 mm	L3 mm
30011	3-12	75	22	12
	12-17	101	31.5	14
	17-25	125	47.1	19
	25-32	148.6	57	21

4
PCS



± 215 x 165 x 51 mm

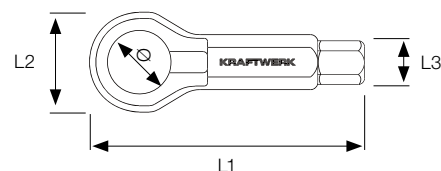

Torque angle gauge
Goniómetro
Goniómetro

Art.		Max. Nm
2037	1/2"	ca. 280



Torque angle gauge with magnet arm
Goniómetro con imán
Goniómetro con brazo magnético

Art.		Max. Nm
2038.1	1/2"	ca. 280



Torque angle gauge with clip arm
Goniómetro con pinza
Goniómetro con brazo de clip

Art.		Max. Nm
2038.2	1/2"	ca. 280

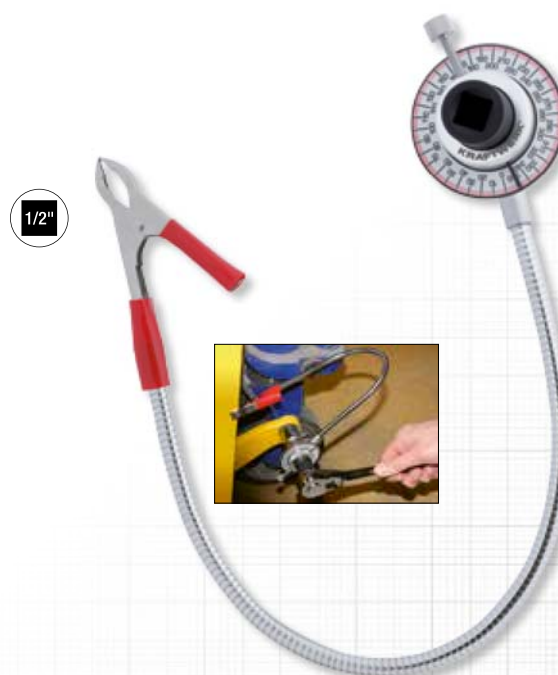

Torque wrench

with scale for values in Nm and Lb.ft. Instant reversible 45 teeth ratchet head. Hardened steel casing and ergonomic adjusting handle. Certified precision $\pm 4\%$.

Llave dinamométrica

con escala de valores en Nm y Lb.ft. Carraca reversible instantánea 45 dientes. Carcasa en acero reforzado y mango de ajuste ergonómico. Precisión certificada: $\pm 4\%$.

Chave dinamométrica

com escala para valores em Nm e Lb.ft. Reversível instantâneo com cabeça de 45 dentes em aço endurecido e punho ajustável ergonómico. Precisão certificada: $\pm 4\%$.

Art.	■	< ~ >	A Nm	L mm
2041	3/8"	5 - 25 Nm 4 - 19 Lb.ft	0.1	280
2041E	3/8"	Repair kit Kit de reparo Kit de reparação		
2040	1/2"	42 - 210 Nm 30 - 155 Lb.ft	1.0	470
2040E	1/2"	Repair kit Kit de reparo Kit de reparação		

3/8" 1/2"

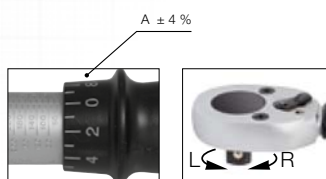
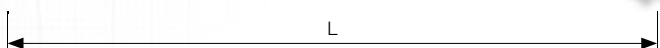

Art. 2040E / 2041E

Click torque wrench

with window scale for values in Nm and Lb.in. Instant reversible 45 teeth ratchet head. Hardened steel casing and ergonomic 2-component handle with locking adjusting knob. Certified precision: $\pm 4\%$.

Llave dinamométrica click

con ventana y valores en Nm y Lb.in. Carraca reversible instantánea 45 dientes. Carcasa en acero reforzado y mango ergonómico bimaterial con botón de ajuste. Precisión certificada: $\pm 4\%$.

Chave dinamométrica

com janela de escala para valores em Nm e Lb.in. Reversível instantâneo com cabeça de 45 dentes em aço endurecido e punho ergonómico de 2 componentes com bloqueio ajustável. Precisão certificada: $\pm 4\%$.

1/4" 3/8" 1/2" 3/4"

ergokraft



DIN 3122 / ISO 3315

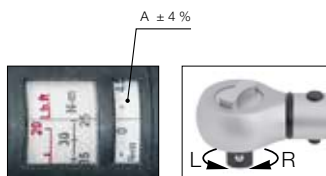

Art.	■	< ~ >	A Nm	L mm
3231	1/4"	2.5 - 12 Nm 20 - 105 Lb.in	0.05	285
3232	1/4"	4 - 20 Nm 30 - 180 Lb.in	0.05	285
3233	3/8"	10 - 60 Nm 9 - 45 Lb.ft	0.125	383
3234	3/8"	25 - 125 Nm 20 - 90 Lb.ft	0.25	438
3235	1/2"	40 - 200 Nm 30 - 150 Lb.ft	0.5	463
3236	1/2"	65 - 335 Nm 50 - 250 Lb.ft	0.5	523
3237	3/4"	160 - 800 Nm 120 - 600 Lb.ft	2.0	1040

Electronic HIGHTECH torque-adapter

Can be used as a torque adapter with every drive element like e.g. conventional reversible ratchet handles.

- automatic calibration and zero positioning at switching on
- direct measuring indication or set point programming with a visual and acoustic warning at reaching or exceeding of the set point
- Track-/Peak-Mode
- measuring accuracy: $\pm 2\%$ tolerance
- 50 memories
- incl. batteries and test certificate DIN EN ISO 6789

Adaptador dinamométrico electrónico

puede ser utilizado como adaptador de fuerza con todo tipo de elementos como por ejemplo las llaves convencionales de carraca reversibles.

- calibrado automático y posicionamiento a cero al encender
- indicador directo de medición o programación del punto de fuerza establecido con aviso visual y acústico al llegar o superar el mismo
- modo pista / punto máximo
- precisión: $\pm 2\%$
- 50 memorias
- incluye pilas y certificado DIN EN ISO 6789

Adaptador electrónico torque

pode ser usado com qualquer roquete reversível ou rabo de força com quadra.

- calibração automática e posição zero no botão ligar
- indicação de medição direta ou programação do ponto de ajuste com aviso visual e acústico ao alcançar ou excedendo o ponto de ajuste
- modo de procura
- tolerância de erro $\pm 2\%$
- 50 memórias
- inclui baterias e certificado de teste DIN EN ISO 6789



HIGHTECH



DIN EN ISO 6789

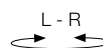

Art. 4081-12, Art. 4081-14, Art. 4081-38

122 x 90 x 65 mm

Art. 4081-34, Art. 4081-341

156 x 110 x 80 mm

Art.	□	< ~ >	3V Li-Mn CR-2032	⊕	L x B mm
4081-14	1/4"	6 - 30 Nm 4.4 - 22.1 Lb.ft	1x	55 h	75 x 45
4081-38	3/8"	27 - 135 Nm 19.9 - 99.6 Lb.ft	1x	55 h	75 x 45
4081-12	1/2"	40 - 200 Nm 29.5 - 147.5 Lb.ft	1x	55 h	75 x 45
Art.	□	< ~ >	1.5V LR6-AA	⊕	L x B mm
4081-34	3/4"	100 - 500 Nm 73.8 - 369 Lb.ft	2x	110 h	100 x 56
4081-341	3/4"	200 - 1000 Nm 147.6 - 738 Lb.ft	2x	110 h	100 x 56

Digital torque / angle adapter

for tightening of screws at preset torque and/or angle values without changing tools. For clockwise and counter-clockwise tightening. Peak-/Track-mode. Read-out in lb.ft, lb.in or Nm. LED display and audible signal at achieved preset values. Presetting of 10 values, 50 memories.

Including 2 AA-batteries and test certificate DIN EN ISO 6789.

Dispositivo dinamométrico digital / Adaptador angular

para apretar tornillos de forma controlada y definida incluso valores angulares sin cambiar de herramienta. Apriete en 2 sentidos, modo Peak-/Track. Lectura seleccionable en lb.ft, lb.in o Nm. Doble indicación: luminosa (LED) y acústica al llegar al valor seleccionado. Preselección 10 valores, 50 memorias. Incluye 2 baterías AA y certificado DIN EN ISO 6789.

Dispositivo dinamométrico digital / Adaptador angular

para apertar parafusos de forma controlada e definida incluindo valores angulares sem trocar de ferramenta. Aperto em 2 sentidos. Modo Peak-/Track. Indicação em lb.ft, lb.in ou Nm. Indicação dupla: luminosa (LED) e sonora ao atingir o valor seleccionado. Possibilidade de pré-seleccionar 10 valores, 50 memórias. Inclui 2 baterias AA e certificado DIN EN ISO 6789.

2 batterie tipo AA e certificato di collaudo DIN EN ISO 6789 inclusi.



Art.		
4082-12	40-200 Nm (±2%)	5°~ 360° (+/- 1%)

Magnetic holder

for sockets and pneumatic tools

Soporte magnético

para herramientas neumáticas

Suporte magnético

para ferramentas pneumáticas

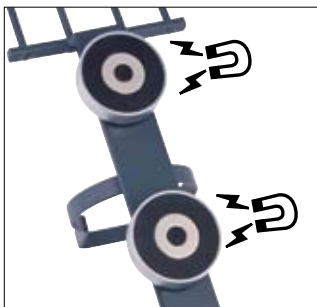

Art.	L mm
3929	400



Flexible telescope magnetic pick-up
Dedo magnético telescópico flexible
Pesca peças flexível magnético telescópico

Art.	Ø mm	L mm
3197	11	135 - 570



1500 g



4-in-1 Magnetic pick-up set
Juego dedos magnéticos 4 en 1
Kit 4-em-1 pesca peças magnético e espelho

Art.	L mm
3188	130 - 630



4
PCS

1500 g

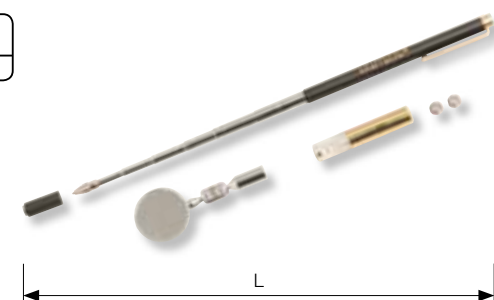

Telescope magnetic pick-up
Dedo magnético telescópico
Pesca peças telescópico magnético

Art.	Ø mm	L mm
3196	11	130 - 630



2000 g



Heavy duty flexible magnetic pick-up
Dedo magnético flexible
Pesca peças flexível magnético

Art.	Ø mm	L mm
3195	18	520



3500 g

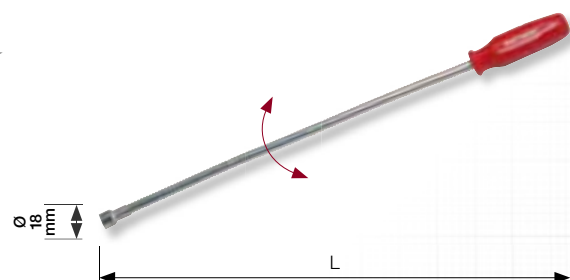

Flexible pick-up claw with magnet
Garra magnética flexible
Garra flexível com íman

Art.	L mm
3198	700



1000 g

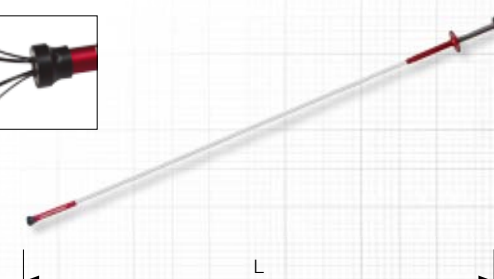

Magnetic pick-up, LED and mirror-set
Estuche dedos magnéticos/LED/set espejos
Kit pesca peças, espelho, LED

5
PCS

Art.	L mm
3190	176 - 660

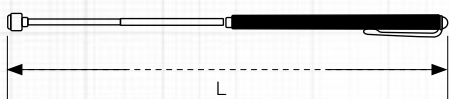
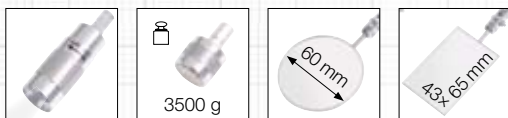

↕ 245 x 117 x 49 mm

Magnetic tray

stainless

Bandeja magnética

inox

Recipiente magnético

em aço inox

Art.
2950



1200 g



↕ Ø 150 x 40 mm

Magnetic tray

stainless

Bandeja magnética

inox

Recipiente magnético

em aço inox

Art.
2951



2x 1200 g



↕ 240 x 140 x 40 mm

Multi-function air-ratchet wrench
Carraca neumática multifunción
Roquete neumático

1/4"	40.7	6.7-40.7	850	>3	85
0.5	155	1/4"	10	113	6.2-7
Art.	L mm				
31011	156				



Air ratchet wrench, reversible
Carraca neumática
Roquete neumático

68	14-60	160	<4	90	260
1/4"	10	BSP	164	10	6.3
Art.		L mm	kg		
31012	3/8"	260	1.20		
31013	1/2"	260	1.22		



Blow-out gun for compressed air

- controlled air flow
- ergonomic handle

Sopladora de aire comprimido

- con flujo de aire controlado
- mango ergonómico

Pistola de soprar

- com ar comprimido controlado
- punho ergonómico

1/4"	132	1/4" BSP	14	<75

Art.	L1 mm	L2 mm	L3 mm
31030	240	100	80

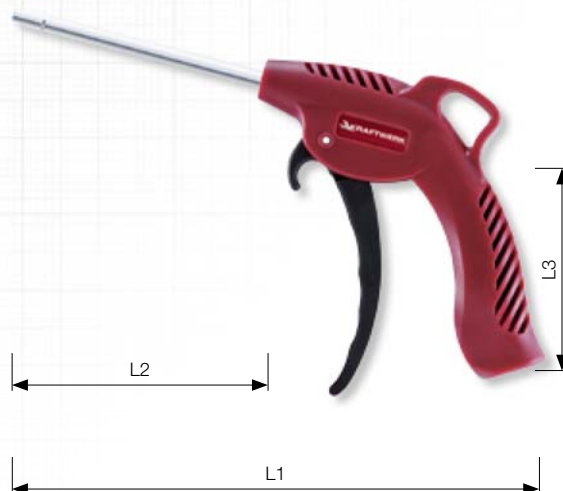

Telescopic blow-out gun for compressed air

- telescopic swivel nozzle
- ergonomic handle

Sopladora extensible de aire comprimido

- con ajuste del ángulo de la boquilla
- mango ergonómico

Pistola de soprar extensível

- com ponta giratória telescópica
- punho ergonómico

1/4"	144	1/4" BSP	14	<73

Art.	L1 mm	L2 mm	L3 mm
31031	300-435	165-300	80

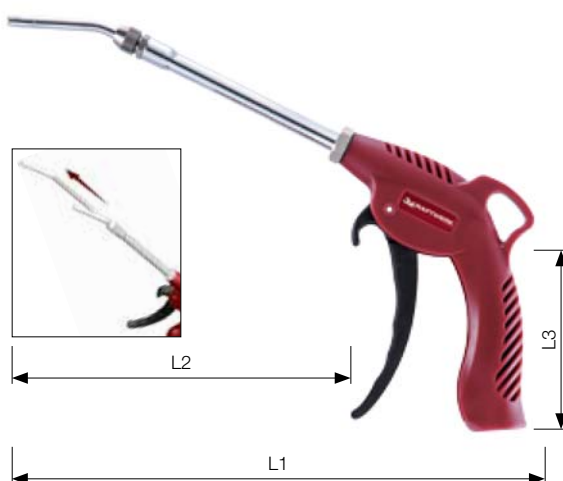

Blow-out gun for compressed air

with turbo nozzle and progressive airflow increment

Sopladora de aire comprimido

con boquilla efecto turbo y incremento progresivo del flujo de aire

Pistola de soprar

com ponta turbo e incremento progressivo do fluxo de ar

1/4"	467	1/4" BSP	14	<85

Art.	L1 mm	L2 mm	L3 mm
31032	180	40	80



Mini blow-out gun for compressed air







with turbo nozzle and progressive airflow increment

Mini sopladora de aire comprimido

con boquilla efecto turbo y incremento progresivo del flujo de aire

Mini pistola de soprar

com ponta turbo e incremento progressivo do fluxo de ar

 AIRFLOW	 AIRFLOW	 AIRFLOW	 max. bar	 dBA	 °C
1/4"	184	1/4" BSP	8	<88	-20~80

Art.	L mm
31033	108



Rubber tip

for cleaning of pipes

Punta caucho diámetro

para limpiar conductos

Ponta de borracha

para limpeza de tubos

Art.	Ø mm / inch
31034	12.7 / 1/2
31035	25.4 / 1
31036	34.9 / 1 3/8

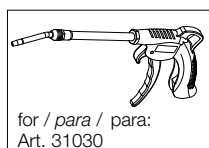
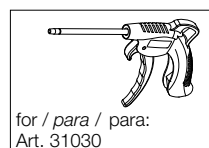

Aluminium star nozzle

for air pressure reduction

Boquilla aluminio estrella

para la reducción de la presión de aire

Ponta de alumínio estrela

para redução de pressão de ar



Art.	Ø mm
31037	6

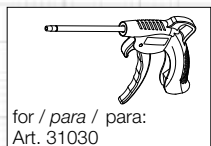

Aluminium turbo power nozzle

for increasing of the airflow

Boquilla aluminio turbopower

para incrementar de la presión de aire

Ponta de alumínio turbo

para aumento de pressão de ar



Art.	Ø mm
31038	10

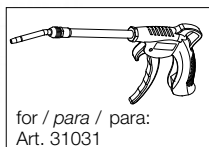
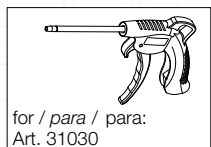

Protection shield

protects from splashes and particles

Escudo de aire

protege contra partículas y líquidos

Protecção de ar

proteger contra salpicos e partículas



Art.	Ø mm
31039	97

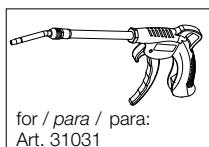
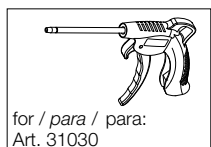

Remover and pick set
Juego de ganzúas y picos
Conjunto de ganchos e furadores

7
PCS



ergokraft

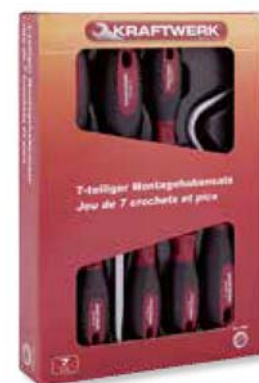

Art.

4322

Telescopic ratchet pry bar

- ideal for use at difficult locations to reach
- adjustable head, lockable in 8 different positions
- ratchet mechanism during lifting
- high lever force
- 2 components ergonomic handle for best safety
- continuous variable telescopic bar, lockable

Palanca carraca articulada telescópica

- para uso en sitios de difícil acceso
- cabeza ajustable que se puede fijar en 8 ángulos diferentes
- mecanismo de carraca para apalancar
- efecto de palanca de gran elevación
- mango ergonómico bimatériau para mayor seguridad
- barra telescópica ajustable

Alavanca flexível efeito roquete

- para usar e chegar a sítios difíceis
- cabeça ajustável pode ser fixa em 8 posições diferentes
- mecanismo de roquete durante a elevação
- alta acção de alavanca
- cabo em bimatéria para uma melhor segurança
- barra telescópica ajustável



ergokraft

Art.

L > <
mm / inch

3337-18-30

450-750 / 18-30



Video

[KRAFTWERKtools.com/video/3337](https://www.kraftwerktools.com/video/3337)

Aluminium working platform

Plataforma de trabajo en aluminio

Plataforma de trabalho em alumínio



Art.

L1
mm

L2
mm

L3
mm

kg

3985

965

480

300

8.2

max.
200
kg



20 W rechargeable Color Control work lamp HIGH CRI COB-LED

designed specifically for the correct color matching and quality control. Suitable for painting and body shops. Special wide-angle COB LED with very high CRI (Color Rendering Index) of 95 achieves almost daylight conditions for natural color reproduction. Wireless, portable, and applicable on tripods and with exclusive rolling stand.

The Color Control lamp therefore is perfect for all painting, polishing, cleaning and preparation jobs, as

- selection of the right color tone
- the matching of the selected color tone with sample-cards
- checking the opacity of the original paint
- the recognition of non-metallic and metallic paints
- uncovering defects before painting
- quality control after the finish
- easy visualization of color differences, scratches, silicone and grinding marks
- optimal additional light for all repair and painting jobs

Foco recargable 20 W Color-Control con HIGH CRI COB-LED

diseñada especialmente para encontrar el tono de color ideal y pasar los controles de calidad. Está perfectamente adaptada para el trabajo en talleres de chapa y pintura. El COB LED especial con gran ángulo de luminosidad tiene un valor CRI (Índice de Reproducción Cromática) muy elevado de 95, muy cercano a la luz del día para una reproducción natural del color.

Inalámbrico, portable y montado en trípode, así como con otros soportes sobre ruedas, la lámpara se adecua perfectamente para todos los trabajos de lacado, pulido, mantenimiento y preparación, tales como:

- selección del tono de color adecuado
- ajuste del color seleccionado con las muestras de la paleta de colores
- control de la cobertura de base
- reconocimiento de las imperfecciones del lacado
- control de la calidad previo al lacado
- control de la calidad final
- visualización ligera de diferencias de color, rasguños y residuos
- iluminación adicional óptima en todos los trabajos de reparaciones y lacado

Foco recarregável 20 W Controlo de cor HIGH CRI COB-LED

concebido especificamente para o acerto correcto de cor e o seu controlo de qualidade. Este foco adequa-se a trabalhos de pintura e bate-chapas. O amplo ângulo do LED COB possui um alto índice de reprodução de cor e atinge quase as condições de luz natural solar, para recriar a cor natural dos objectos.

Sem fios, portátil, compatível com os tripés standard e um suporte exclusivo

O foco de controlo de cor é perfeito para todo o tipo de pinturas, polimento, limpeza e preparação tais como:

- selecção da tonalidade de cor correcta
- a correspondência do tom de cor seleccionado através de cartões de teste
- verificar a opacidade da pintura original
- reconhecimento de partes metálicas e não metálicas
- revelar defeitos antes da pintura
- controlo de qualidade após acabamento
- fácil visualização das diferenças de cor, riscos, e marcas de silicone ou preparação
- iluminação adicional para todo o tipo de reparações e serviços de pintura



Li-Ion 11.1 V (4400 mAh)



↕ 225 × 220 × 70 mm

**20 W HIGH
CRI COB* LED**

* Chip On Board

CRI: 95

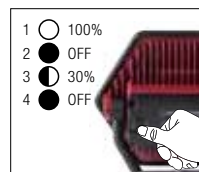

Art.



32030

20 W HIGH CRI COB* LED

Rechargeable 20 W COB LED power work and spotlight

- with exceeding light power and energy-saving
- with wide light angle of 120°
- 2 light levels: Full power / 30 % performance
- very long life and low operating temperature grace to high quality COB-LED
- cordless for everywhere use with the strong Li-Ion battery 11.1 V (4400 mAh)
- solid and lightweight aluminium housing for industrial use
- integrated, flexible, 180° swivelling stand, portable and mountable on special tripods
- IP 65, protected against strong water jets and dust protected, ideal for outdoor and indoor use

Foco recargable 20 W COB LED

- con luminosidad excepcional
- ángulo de luminosidad de 120°
- 2 niveles de intensidad de luz: plena y al 30%.
- larga vida útil y baja temperatura de funcionamiento gracias a los LED-COB de alta calidad
- inalámbrico, con batería potente Li-Ion 11.1V (4400 mAh)
- carcasa sólida y ligera en aluminio para un uso industrial
- asa integrada, flexible, orientable a 180°, portátil o montado en trípodes especiales
- IP 65, protección contra polvo y agua, ideal para uso interior y exterior

Lâmpada de trabalho recarregável 20W COB LED

- com iluminação poderosa
- ângulo de 120°
- 2 níveis de iluminação: Potência máxima / 30% performance
- grande duração e baixa temperatura de operação graças aos LED-COB de alta qualidade
- sem fio para utilização diversa com fortes baterias Li-Ion 11.1V (4400mAh)
- corpo em alumínio leve e sólido para utilização industrial
- suporte rotativo 180° flexível e integrado em tripé portátil e desmontável
- IP 65, protegida contra fortes jactos de água e protecção anti-poeira, ideal para utilização interior e exterior



Li-Ion 11.1 V (4400 mAh)



225 × 220 × 70 mm

20 W COB* LED

* Chip On Board



Art.



32029

20 W COB* LED

40 W COB LED electric industrial work and spotlight

- with even higher light power
- with wide light angle of 120°
- very long life and low operating temperature grace to high quality COB-LED
- solid and lightweight aluminium housing for industrial use
- integrated, flexible, 180° swivelling stand, portable and mountable on special tripods
- IP 65, protected against strong water jets and dust protected, ideal for outdoor and indoor use
- 5 meter rubber cable H05RN-F-3 x 1.0 mm²

Foco eléctrico industrial 40 W COB LED

- con aún más luminosidad
- ángulo de luminosidad de 120°
- larga vida útil y temperatura de funcionamiento baja gracias a los LED-COB de alta calidad
- carcasa sólida y ligera de aluminio para un uso industrial
- asa integrada, flexible, orientable a 180°, portátil o montado en trípodes especiales
- IP 65, protección contra polvo y agua, ideal para uso interior y exterior
- cable de 5 metros H05RN-F-3 x 1.0 mm²

Lâmpada de trabalho eléctrica 40 W COB LED

- com iluminação poderosa
- ângulo de 120°
- grande duração e baixa temperatura de operação graças aos LED-COB de alta qualidade
- corpo em alumínio leve e sólido para utilização industrial
- suporte rotativo 180° flexível e integrado em tripé portátil e desmontável
- IP 65, protegida contra fortes jactos de água e protecção anti-poeira, ideal para utilização interior e exterior
- cabo de borracha com 5 metros H05RN-F-3 x 1.0mm²

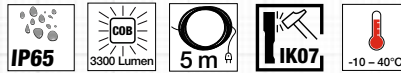

± 270 x 240 x 77 mm



40 W COB* LED
3300 lm
* Chip On Board

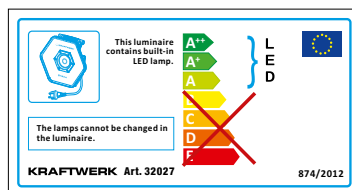

Art.  **32027** 40 W COB* LED

Telescope rolling lamp stand and protected against tipping

Trípode telescópico sobre ruedas y antivuelco

Tripé extensível com rodas e protegido contra quedas

Art.	Ø mm	L1 min. mm	L2 max. mm
32025-4	550	485	1520



Electric industrial work and spotlight



with telescope rolling lamp stand and protected against tipping

Foco eléctrico industrial

con trípode telescópico sobre ruedas y antivuelco

Lâmpada de trabalho eléctrica

com tripé extensível com rodas e protegido contra quedas

Art.	Art. 	
32027D	32027	40 W COB LED
32029D	32029	20 W COB LED
32030D	32030	20 W HIGH CRI COB LED



Art. 32027D



Art. 32029D



Art. 32030D

Neon lead lamp

with 5 m cable H05RN-F 2 x 1.0 mm²

Lámpara neón

con 5 m cable caucho H05RN-F 2 x 1.0 mm²

Gambiarra fluorescente

com 5 m de cabo em borracha H05RN-F 2 x 1.0 mm²



FL 8W
220-240V / 50/60 HZ



↕ L 435 mm

Art.	
1891	FL 8W

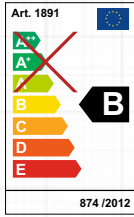

Electric workshop- and inspection lamp

- with 9 strong SMD-LED
- light angle 120°
- rubberized housing
- very solid construction, developed for the professional constant operation
- waterproof and shockproof
- 5 meter power cable

Lámpara de trabajo con cable

- con 9 potentes SMD-LED
- ángulo de luminosidad 120°
- recubrimiento en caucho
- muy sólida, apta para un trabajo profesional constante
- resistente a agua y golpes
- 5 metros de cable

Gambiarra de oficina eléctrica

- com 9 fortes LEDs SMD
- ângulo de 120°
- carcaça protegida por borracha
- construção sólida, desenvolvida para utilização profissional constante
- resistente a água e quedas
- cabo de ligação 5 metros



9 SMD LED
250 LUX (0.6 m)
350 lm



↕ 285 x 59 x 52 mm

Art.	
32034	9 SMD LED

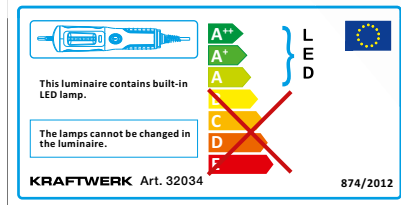
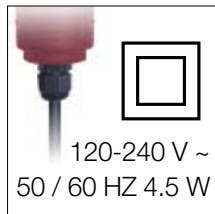
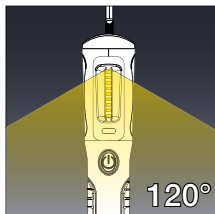

3 W 10 + 1 SMD LED rechargeable cordless lamp

- extremely flat head for illuminating also places with difficult access
- 10 lateral SMD LED with special high power
- 1 additional SMD LED on the light head
- 2 sides variable swivel 180° / 180° turning head
- built-in strong magnetic holder in the base
- rubber-coated case for good grip
- solid, impact resistant shell, made of aluminium
- with automatic shut-off and over charge protection
- including AC main charger with mini USB-connector

Lámpara recargable 3 W 10 + 1 SMD LED

- cabezal superplano para uso en sitios de difícil acceso
- 10 SMD LED laterales con gran luminosidad
- 1 SMD LED adicional en la cabeza
- orientable en 2 posiciones a 180° / cabeza giratoria 180°
- base con soporte magnético
- cobertura goma para mejor sujeción
- carcasa sólida, resistente a golpes, fabricada en aluminio
- con apagado automático con protección para sobrecargas
- incluye cargador a red con mini conector USB

Gambiarra 3 W 10 + 1 SMD LED recarregável

- cabeça extremamente fina para iluminar em lugares de difícil acesso
- 10 SMD LED laterais de alta luminosidade
- 1 SMD LED adicional na ponta
- 2 lados variáveis giratórios 180° / cabeça articulada 180°
- base com forte magnético incorporado
- revestimento de borracha
- sólido, resistente ao impacto, fabricado em alumínio
- com auto-off automático e protector de excesso carga
- inclui carregador AC com ligação mini USB



Li-Ion 3.7 V (2200 mAh)



10 SMD LED
90-110 LUX (1m)
260-300 lm

Art.	
32018	10 SMD LED / 1 SMD LED



↕ L 372.5 mm

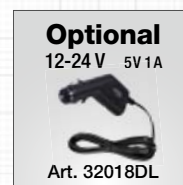
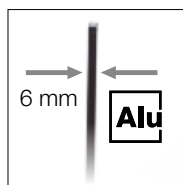
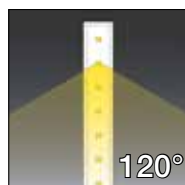
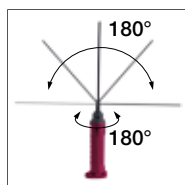

15 W SMD LED 240 V work lamp

for motor, interior and under the car

- very bright 15 W SMD LED bulb
- electronic ballast for quicker start and longer life
- ratcheting hooks provide safe and firm attachment
- extensible and rotatable hooks from 113.8 to 190 cm
- for the utilization with most SUV and trucks
- soft coated padded hooks prevent scratching of the vehicles surface
- large hook design for the use as an interior and under car light
- 5 m cord H05WF 2 x 0.75mm²

Lámpara 15 W SMD LED de trabajo

240V para usar en el capó, debajo e interior de coche

- súper brillante, tubo SMD LED 15W
- casquillo electrónico para encendido rápido y de larga vida
- ganchos con trinquete para más seguridad y agarre firme
- ganchos telescópicos de entre 113.8-190 cm
- se engancha a la mayoría de los todo terreno y camiones
- recubrimiento blando de los ganchos previenen arañazos en la superficie de los vehículos
- gran forma del gancho permite que la lámpara sea utilizada también en el interior y debajo del coche
- cable: H05WF 2 x 0.75 mm²

Lâmpada de trabalho 15 W SMD LED

para capô, motor, interior e por baixo do carro, 240V

- LED brilhante 15 W SMD LED
- casquilho eletrônico para um início mais rápido e maior tempo de vida
- ganchos com roquete para uma fixação segura e firme
- ganchos telescópicos e rotativos de 113.8 a 190 cm
- para utilização em SUV e caminhão
- ganchos acolchoados e revestidos evitar arranhar a superfície dos veículos
- ganchos grandes para utilizar tanto no interior como no exterior do carro
- 5 m cabo, H05WF 2 x 0.75 mm²

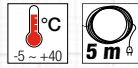

15W SMD-LED
150-400 LUX (1m)
400-1200 lm

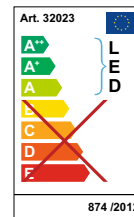
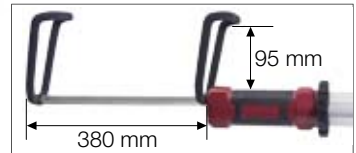

↕ 1138-1900 mm

Art.	
32023	15W SMD

Rechargeable 7 W SMD LED work light

for bonnet area, interior and under the car delivered with universal charger 100-240 V

Lámpara recargable de trabajo 7W SMD-LED

para usar en el capó, debajo e interior de coche suministrado con cargador universal 100-240 V

Lâmpada recarregável 7W SMD-LED

para capô, motor, interior e por baixo do carro entregue com carregador universal 100-240 V

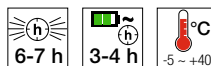

Li-Ion 7.4V (4000 mAh)

7W SMD-LED
150-200 LUX (1m)
450-550 lm

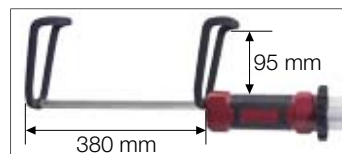

↕ 1200-1900 mm











Art.	
32024	7W SMD



Technical characteristics :

Especificaciones técnicas:

Especificações técnicas:

DIN	Manufactured according to DIN specifications <i>Fabricado según estándares DIN</i> Fabricadas de acordo com normas DIN	HSS	High speed steel <i>Acero super rápido</i> Aço rápido
ISO	Manufactured according to ISO specifications <i>Fabricado según las normas ISO</i> Fabricado de acordo com as normas ISO	inox	Stainless steel <i>Acero inoxidable</i> Aço inoxidável
	Weight <i>Peso</i> Peso	Medium	Hardness grade <i>Grado de dureza</i> Grau de Dureza
	Dimensions <i>Dimensiones</i> Dimensões	steel	Steel <i>Acero</i> Aço
inch	Inch sizes <i>Dimensiones en pulgadas</i> Dimensões em polegadas	S2 quality	Tool steel S2 (chrome-silicium-manganese-molybdenum-vanadium steel) <i>Acero de calidad S2 (cromo-silicio-manganeso, molibdeno y vanadio)</i> Aço de qualidade S2 (cromo-silício-manganês, molibdênio e vanádio)
	Ratchet mechanism, number of teeth per revolution <i>Mecanismo de trinquete, número de dientes por revolución</i> Mecanismo de roquete, número de dentes por revolução	R L	Right / Left switchable <i>Reversible izquierda/derecha</i> Reversível direita / esquerda
	Use with impact wrenches <i>Para el uso con llave de impacto</i> Para uso com chave de impacto	0 T	Lifting weight tons <i>Capacidad en toneladas</i> Capacidade em Toneladas
	Aluminium rims <i>Llantas aluminio</i> Jante de Alumínio	000 Nm	Torque <i>Grado de fuerza</i> Torque
	Ejection ratchet <i>Carraca con sistema de extracción</i> Roquete com sistema de ejeção	00 Lb.ft	Torque <i>Grado de fuerza</i> Torque
	Magnetic <i>Magnético</i> Magnético	Composite	Composite <i>Materiaial composite</i> Composito
	Locking <i>Bloqueo</i> Bloqueio	water-resistant	Water resistant <i>Impermeable</i> Resistente a Água
	Antislip <i>Antideslizante</i> Antiderrapante		Temperature Celsius <i>Temperatura centigrados</i> Temperatura Celsius
ABS	Acrylonitrile-butadiene-styrene copolymer <i>Acrilonitrilo-Butadieno-Estireno</i> Acrilonitrila Butadieno Estireno	flex	Flexible <i>Flexible</i> Flexível
Alu	Aluminium <i>Aluminio</i> Allumínio	0 m	Cable length <i>Longitud cable</i> Comprimento do Cabo
CrMo	Chromium-molybdenum <i>Cromo-Molibdeno</i> Cromo-Molibdênio		Charging time <i>Tiempo de carga</i> Tempo de Carga
CrV	Chrome-vanadium <i>Cromo-vanadio</i> Chrome-Vanadium		

KRAFTWERK Group



KRAFTWERK Europe AG
Mettlenbachstrasse 23
CH-8617 Mönchaltorf

Tel.: +41 44 949 40 50
Fax: +41 44 948 11 58

E-Mail: info@kraftwerk.ch
Web: www.kraftwerk.ch



KRAFTWERK Sàrl.
25, rue du Stade
FR-67870 Bischoffsheim

Tel.: +33 388 48 64 50
Fax: +33 388 50 27 32

E-Mail: info@kraftwerk.fr
Web: www.kraftwerk.eu



KRAFTWERK Deutschland GmbH
Lebacher Strasse 4
DE-66113 Saarbrücken

Tel.: +49 681 / 99 63 647
Fax: +49 681 / 99 63 646

E-Mail: info@de.kraftwerk.eu
Web: www.kraftwerk.eu



KRAFTWERK IBERICA S.L.
C/De las Vacas, no. 6, oficina 5
ES-28341 Valdemoro (Madrid)

Tel.: +34 91 809 22 97
Fax: +34 91 809 49 33

E-Mail: kraftwerk@futurnet.es
Web: www.kraftwerk.eu

KRAFTWERK Partners in Europe



A/S H. Sindby & Co.
Bommerhavevej 41, Sjelde
DK-7100 Vejle

Tel.: +45 75 88 21 22
Fax: +45 75 88 22 40

E-Mail: sindby@sindby.dk
Order: ordre@sindby.dk
Web: www.sindby.dk



PROFIKRAFT TRADING, s.r.o.
Bráfova 6
CZ-Brno 616 00

Tel.: +420 541 249 260
Fax: +420 541 249 261

E-Mail: profikraft@profikraft.cz
Web: www.profikraft.cz



Tecniverca-Máquinas Ferramentas, Lda
Estrada Municipal 1022, nº339
PT-2860-302 Pinhal de Areia-Moita

Tel.: +351 219 584 273
Fax: +351 219 577 133

E-Mail: tecniverca@tecniverca.pt
Web: www.tecniverca.pt



Van Heck - Interpieces N.V.
Havendoklaan 14
BE-1804 Vilvoorde

Tel.: +32 2 255 84 50
Fax: +32 2 255 84 59

Web: www.vhjp.be



Fource
Hogebrinkerweg 18
NL-3871 KN Hoevelaken

Tel.: +31 88 123 06 05
Fax: +31 88 123 06 51

E-Mail: tools@fource.nl
Web: www.toolspecial.com



Techno-Elit & Co. KG
Hatzianesti 6
GR-18233 A.L.Rentis-Athen

Tel.: +30 210 4900064
Fax: +30 210 4900072

E-Mail: info@techno-elit.gr
Web: www.techno-elit.gr



FLESCH EXPORT-IMPORT
Fohlenweg 7
CH-9230 Flawil

Tel. RS: +38 162 587644
Tel. BiH: +38 765 197739

E-Mail: zivkoflesch@gmail.com
Web: www.flesch-export-import.com



Hosendorfer Ges.m.b.H.
Wodkigasse 7
AT-2353 Guntramsdorf/Wien

Tel.: +43 2236 53491
Fax: +43 2236 52347

E-Mail: office@hosendorfer.at
Web: www.kraftwerk-hosendorfer.at



Parts-Center NT
Rruga Tirana p.n.
KO-20000 Prizren

Tel.: +377 44 337 620; 646 920
Fax: +381 29 222 155

E-Mail: n.biri@parts-center.net
Web: www.parts-center.net



INTENSE s.r.l.
Via Novara 1
IT-20063 Cernusco Sul Naviglio (MI)

Tel.: +39 02 921 8151
Fax: +39 02 921 04594

E-Mail: info@intense.it
Web: www.kraftwerktools.it



Neil Oxborrow
Kraftwerk Tools UK
3 Playfield Road, Capel St. Mary
GB- IP9 2HP Ipswich, Suffolk

Tel.: + 44 7956 411394

E-Mail: neil@kraftwerktoolsonline.co.uk
Web: www.kraftwerktools.co.uk



Logey ehf heildverslun
Vesturvör 7
IS-200 Kópavogur

Tel.: +354 511 2055
Fax: +354 511 2056

E-Mail: logey@logey.is
Web: www.logey.is



Vekra LCC
Tehnika 3
EE-75501 Saku, Harjumaa

Tel.: +372 677 9665

E-Mail: info@vekra.ee
Web: www.vekra.ee



Magnetic Services Ltd.
Vjal Sir Paul Boffa
MT-9023 Paola

Tel.: +356 21676529
Fax: +356 21802161

E-Mail: info@magneticservices.com.mt
Web: www.magneticservices.com.mt



SamZ s.r.o.
Mierova 183
SK- 82105 Bratislava

Tel.: +421 903 701 201

E-Mail: m.zgebura@samz.sk
Web: www.kraftwerk.sk



REBIOP, s.r.o.
SNP 51/2298
SK- 95301 Zlaté Moravce

Tel.: +421 37 630 6303
Fax: +421 37 630 6301

E-Mail: homola@rebiop.sk
Web: www.rebiop.sk



Swedish Levant Trading (CYPRUS) Ltd.
154, Giannou Kranidioti
CY-2235 Latsia

Tel.: +357 22 574 041
Fax: +357 22 574 043

E-Mail: info@swedishlevant.com
Web: www.swedishlevant.com



Oldi & Co.
Lubanas Iela 49
LV-1073 Riga

Tel.: + 371 7248 907
Fax: + 371 7248 906

E-Mail: oldi@oldi.net
Web: www.oldi.net



Dimas Plast Ltd.
63, Shipchenski prohod Blvd.
BG- 1574 Sofia

Tel.: +359 2 978 31 71
Fax: +359 2 978 31 71

E-Mail: info@dimasplast.com
Web: www.carchemie.com

KRAFTWERK Partners in Africa



Kaufmann
65, Bd Mly Ismail
MA-20290 Casablanca

Tel.: +212 522 24 85 85
Fax: +212 522 24 82 86

E-Mail: faouzi.khelifi@kaufmann.ma
Web: www.kaufmann.ma



Windhoek Tool Centre CC
P.O. Box 9660
NA-Windhoek

Tel.: +264 61 263 251
Fax: +264 61 216 421

E-Mail: whktools@mweb.com.na

KRAFTWERK Partners in Middle East



Shimron Technologies
P.O Box 86
110 Haerez Street
IL-90901 Givon Hadasha

Tel.: +972 2 536 24 51

E-Mail: shimrontech@gmail.com
Web: www.shimrontech.co.il



JOY Middle East LLC
Al Quoz 3, Sheikh Zayed Road
Dubai

Tel.: + 971 4 380 53 55

E-Mail: info@joymellc.com
Web: www.joymellc.com



Power Machinery Co.
Pasha Plaza, Floor No. 6
Thaliya Street beside Bughsan Hospital
21431 Jeddah
SA Saudi Arabia

Tel.: +966 12 66 58 011
Fax: +966 12 65 49 384

E-Mail: matthias@aka.com.sa
Web: www.aka.com.sa



Your specialized dealer: | *Su distribuidor especializado* : |
Agente autorizado KRAFTWERK:

DIMARX

Contacto tel. 00 351 93 737 81 80
geral@dimarx.pt - www.dimarx.pt