

OWNER'S MANUAL

How to install, operate and maintain your EcoWater Systems Electronic Demand Water Softener

ECOWATER
S Y S T E M S[®]



Your Water. Perfected.

Models

EEC1502R25
EEC1502R40

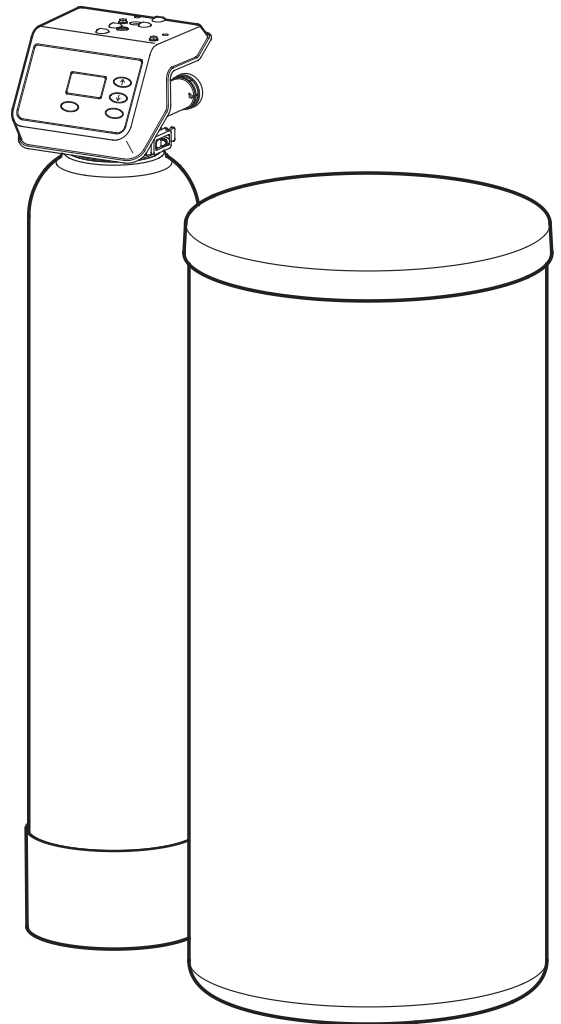

Systems tested and certified by NSF International
against NSF/ANSI Standard 44 for hardness
reduction and efficiency.



Systems tested and certified by the
Water Quality Association against CSA B483.1.



C US



Designed, Engineered &
Assembled in the U.S.A.

EcoWater Systems LLC
P.O. Box 64420, St. Paul, MN 55164-0420
www.ecowater.com

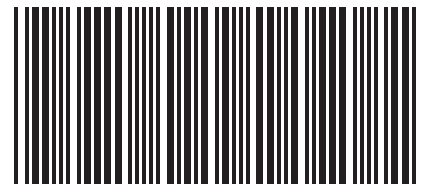

7349023 (Rev. G 5/5/17)

TABLE OF CONTENTS

	<u>Page</u>
Specifications & Performance Claims	3
Dimensions	4
Before Starting Installation	5
Typical Installation Illustrations	6
Installation Instructions	7-9
Sanitizing Procedure	9
Programming the Electronic Controller	10-11
Controller Features / Options	11-13
Routine Maintenance	13-14
Troubleshooting	15-16
Wiring Schematic	17
Repair Parts	18-23
Warranty	24

INSPECT SHIPMENT

The parts required to assemble and install the water softener are included with the unit. Thoroughly check the water softener for possible shipping damage and parts loss. Also inspect and note any damage to the shipping carton.

Remove and discard (or recycle) all packing materials. To avoid loss of small parts, we suggest you keep the small parts in the parts bag until you are ready to use them.

SAFETY GUIDES

Follow the installation instructions carefully. Failure to install the water softener properly voids the warranty.

Before you begin installation, read this entire manual. Then obtain all the materials and tools you will need to make the installation.

Check local plumbing and electrical codes. The installation must conform to them.

Use only lead-free solder and flux for all sweat-solder connections as required by state and federal codes.

Use care when handling the water softener. Do not turn upside down, drop, or set on sharp protrusions.

Do not locate the water softener where freezing temperatures occur. **Do not attempt to treat water over 120°F.** Freezing, or hot water damage voids the warranty.

Avoid installing in direct sunlight. Excessive sun heat may cause distortion or other damage to non-metallic parts.

The water softener requires a minimum water flow of 3 gallons per minute at the inlet.

Recommended **maximum allowable inlet water pressure is 125 psi.** If daytime pressure is over 80 psi, nighttime pressure may exceed the maximum. Use a pressure reducing valve if necessary. Be sure the addition of a pressure reducing valve will not reduce the flow to less than the 3 gallons per minute.

The water softener works on **24V DC** electrical power, supplied by a direct plug-in power supply (included). Be sure to use the included power supply, and plug it into a nominal **120V, 60 Hz** household outlet that is in a **dry location only**, grounded and properly protected by an overcurrent device such as circuit breaker or fuse.

This system is not intended to be used for treating water that is microbiologically unsafe or of unknown quality without adequate disinfection before or after the system.



European Directive 2002/96/EC requires all electrical and electronic equipment to be disposed of according to Waste Electrical and Electronic Equipment (WEEE) requirements. This directive or similar laws are in place nationally and can vary from region to region. Please refer to your state and local laws for proper disposal of this equipment.

These models are efficiency rated. The efficiency rating is valid only at the minimum salt dose and the service flow rate. The softeners have a demand initiated regeneration (D.I.R) feature that complies with specific performance specifications intended to minimize the amount of regenerant brine and water used in their operation.

These softeners have a rated softener efficiency of not less than 3,350 grains of total hardness exchange per pound of salt (based on sodium chloride) and shall not deliver more salt than their listed rating or be operated at a sustained maximum service flow rate greater than their listed rating. These softeners have been proven to deliver soft water for at least ten continuous minutes at the rated service flow rate. The rated salt efficiency is measured by laboratory tests described in NSF/ANSI Standard 44. These tests represent the maximum possible efficiency that the system can achieve. Operational efficiency is the actual efficiency after the system has been installed. It is typically less than the rated efficiency, due to individual application factors including water hardness, water usage, and other contaminants that reduce a softener's capacity.

SPECIFICATIONS		
Model	EEC 1502R25	EEC 1502R40
Model Code	EC25	EC40
Rated Softening Capacity (grains @ lb. salt dose)	10,500 @ 2.1 22,200 @ 6.6 26,600 @ 11.2	11,700 @ 2.3 30,800 @ 8.5 39,000 @ 14.7
Rated Efficiency (grains / lb. @ minimum salt dose)	5,000 @ 2.1	5,070 @ 2.3
Water Used During Regeneration @ Minimum Salt Dose	3.0 gal. / 1,000 grains	3.3 gal. / 1,000 grains
Total Water Used Per Regeneration @ Maximum Salt Dose	32.4 gal.	38.3 gal.
Amount of High Capacity Resin	36.4 lbs. (0.70 cu. ft.)	56.2 lbs. (1.08 cu. ft.)
Resin Tank Nominal Size (dia. x height)	8 x 40 in.	9 x 40 in.
Service Flow Rate	6.0 gpm	9.9 gpm
Pressure Drop at Rated Service Flow	10.4 psig	15.0 psig
Intermittent Flow @ 15 psi ▲	7.5 gpm	10.2 gpm
Water Supply Maximum Hardness	70 gpg	110 gpg
Water Supply Maximum Clear Water Iron ■	4 ppm	5 ppm
Min. - Max. Water Supply Pressure ◆	20 - 125 psi	
Min. - Max. Water Supply Temperature	40 - 120 °F	
Minimum Water Supply Flow Rate	3 gpm	
Regeneration Cycle Flow Rates		
Fill (flow to brine tank)	0.3 gpm	0.3 gpm
Brining (flow to drain)	0.15 gpm	0.22 gpm
Brine Rinse (flow to drain)	0.10 gpm	0.15 gpm
Max. Backwash (flow to drain)	2.0 gpm	2.0 gpm
Max. Fast Rinse (flow to drain)	2.0 gpm	2.0 gpm

▲ Intermittent flow rate does not represent the maximum service flow rate used for determining the unit's rated capacity and efficiency. Continuous operation at flow rates greater than the service flow rate may affect capacity and efficiency performance.

■ Capacity to remove clear water iron is substantiated by WQA test data. State of Wisconsin requires additional treatment if water supply contains greater than 5 ppm clear water iron.

◆ Canada working pressure limits: 1.4 - 7.0 kg/cm².

These units conform to NSF/ANSI 44 for the specific performance claims as verified and substantiated by test data.

DIMENSIONS

	EEC 1502R25	EEC 1502R40
Nominal Resin Tank Size	8" dia. x 40" tall	9" dia. x 40" tall
A	45-1/2"	47"
B	41-3/8"	41-3/4"
C	3-3/8"	3-3/4"
D	8-1/4" dia.	9-1/4" dia.

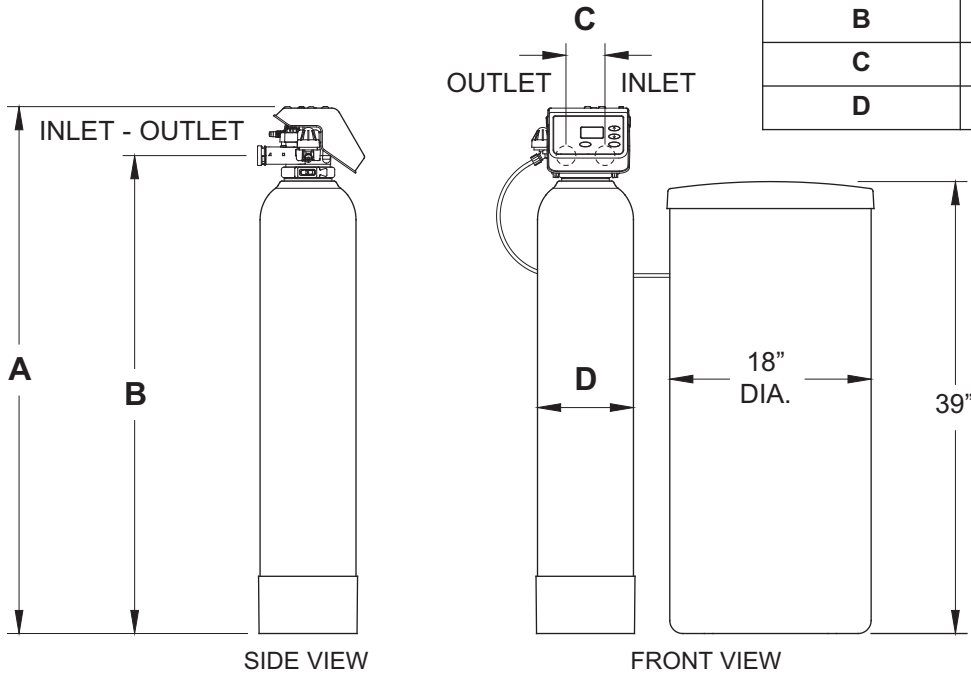
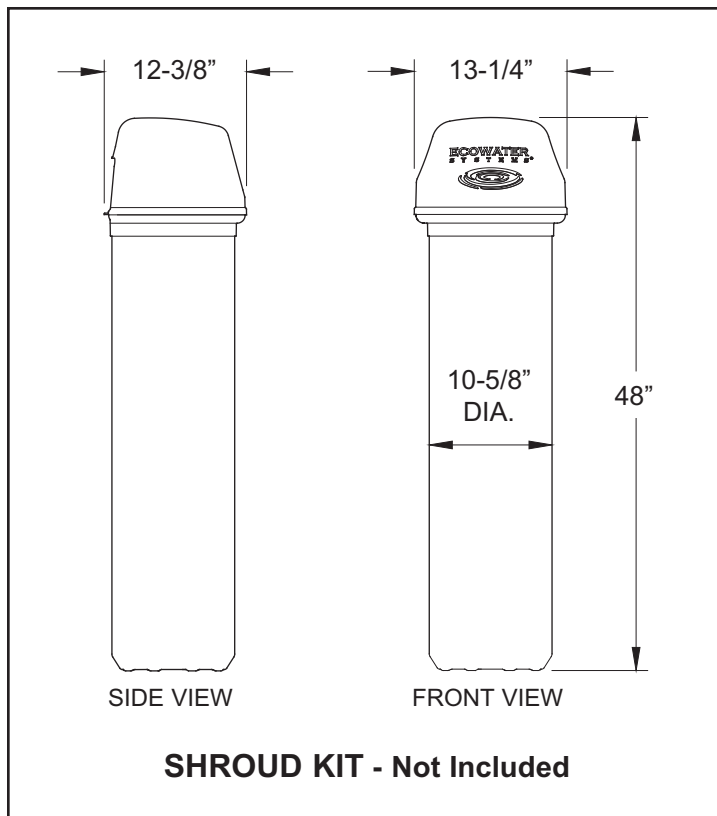

FIG. 1



WHERE TO INSTALL THE SOFTENER

- To soften all water in the home, install the water softener close to the water supply inlet, upstream of all other plumbing connections, **except** outside water pipes. Outside faucets should remain on hard water to conserve salt and softening capacity.
- Place the softener near a floor drain, or other acceptable drain point (laundry tub, sump, stand-pipe, etc.) to carry away regeneration discharge water.
- Connect the softener to the main water supply pipe **UPSTREAM OF** the water heater. **DO NOT RUN HOT WATER THROUGH THE SOFTENER.** The temperature of water passing through the softener must be less than 120°F.
- Do not install the softener in a place where it could freeze. Damage caused by freezing is not covered by the warranty.
- Put the softener in a place water damage is least likely to occur if a leak develops. The manufacturer will not repair or pay for water damage.
- A 120V, 60 Hz electrical outlet, to plug the included power supply into, is needed near the softener. Be sure the electrical outlet and power supply are in an inside location, to protect from wet weather.
- If installing in an outside location, you must take the steps necessary to assure the softener, installation plumbing, wiring, etc., are as well protected from the elements, contamination, vandalism, etc., as when installed indoors.
- Keep the softener out of direct sunlight. The sun's heat may soften and distort plastic parts.

TOOLS, PIPE & FITTINGS, OTHER MATERIALS YOU WILL NEED

- **ALWAYS** install an EcoWater Systems bypass valve, or a 3-valve bypass system. Bypass valves let you turn off water to the softener for repairs if needed, but still have water available to the house pipes.
- Plastic inlet and outlet fittings are included with the softener, which allow water flow equivalent to 1 inch nominal pipe. To maintain maximum valve flow, 1" pipes to and from the softener fittings are recommended. Do not reduce the pipes to less than 3/4" size.
- Use copper, brass or PEX plastic pipe and fittings.
- Drain hose, 1/2" inside diameter minimum, is needed for the valve drain.
- If a rigid valve drain is needed, to comply with plumbing codes, you can buy the parts needed to connect a 1/2" minimum copper tubing drain.

NOTE: The Commonwealth of Massachusetts plumbing code 248-CMR shall be adhered to. A licensed plumber shall be used for this installation.

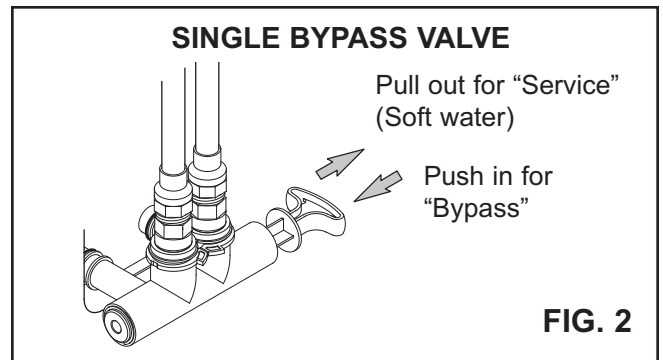

THE PROPER ORDER TO INSTALL WATER TREATMENT EQUIPMENT

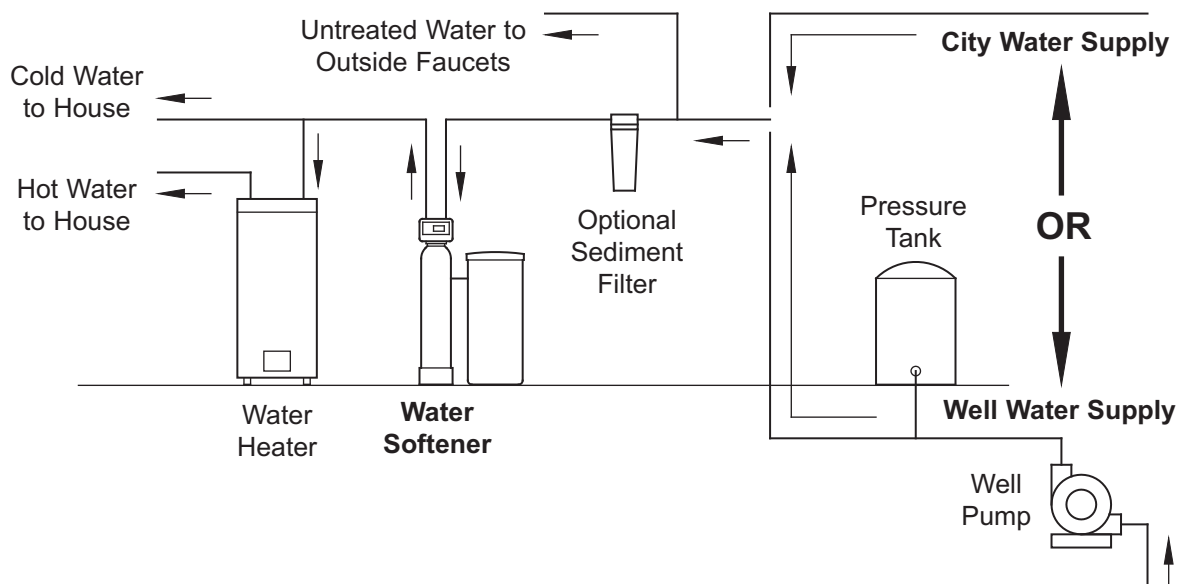

INSTALLATION USING ECOWATER BYPASS VALVE

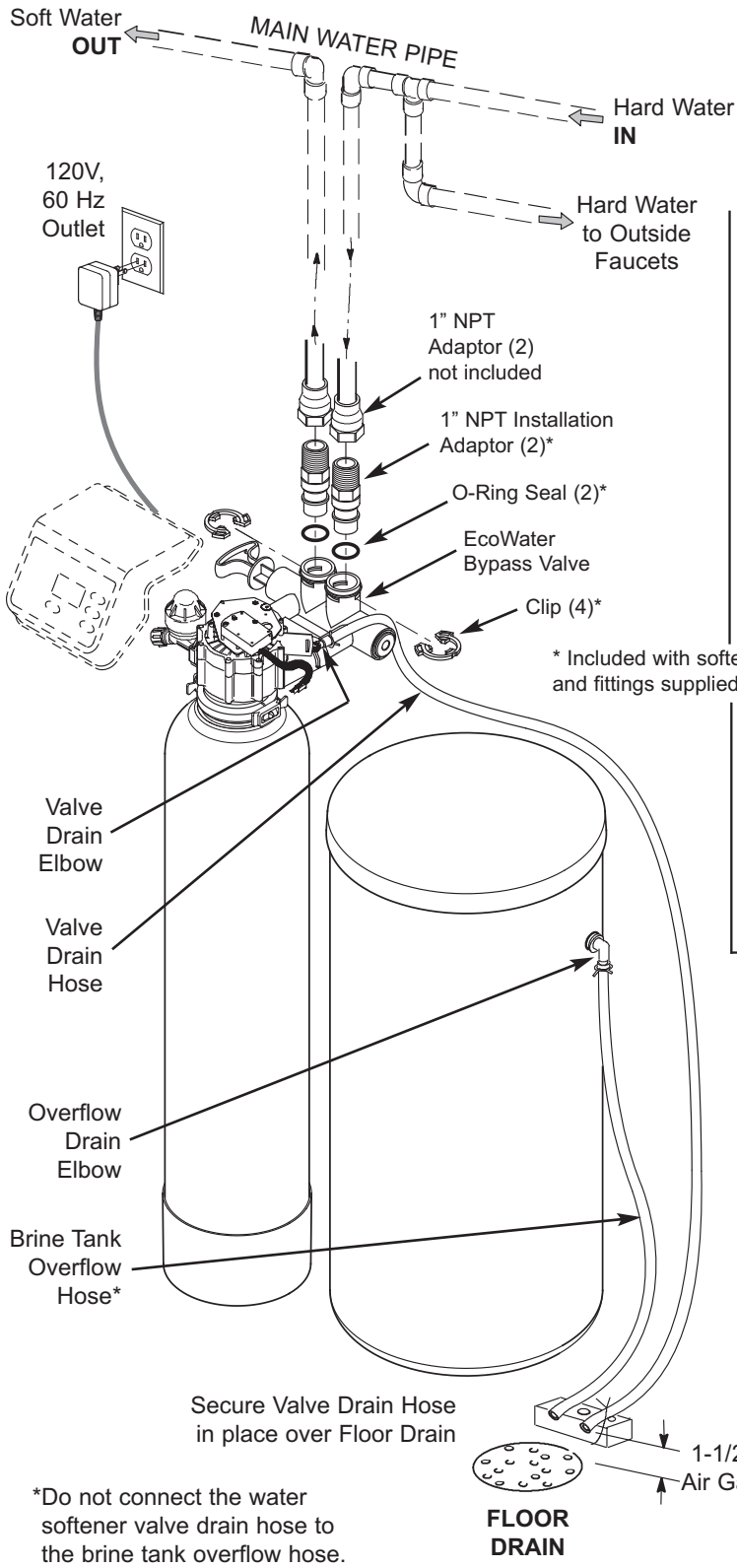

CROSS-OVER

Use if water supply flows from the left. Include single or 3-valve bypass.

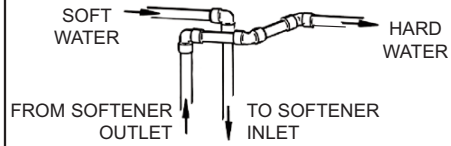

INSTALLATION USING 3-VALVE BYPASS

For soft water SERVICE:
-Open the inlet and outlet valves

For hard water BYPASS:
-Close the inlet and outlet valves
-Open the bypass valve

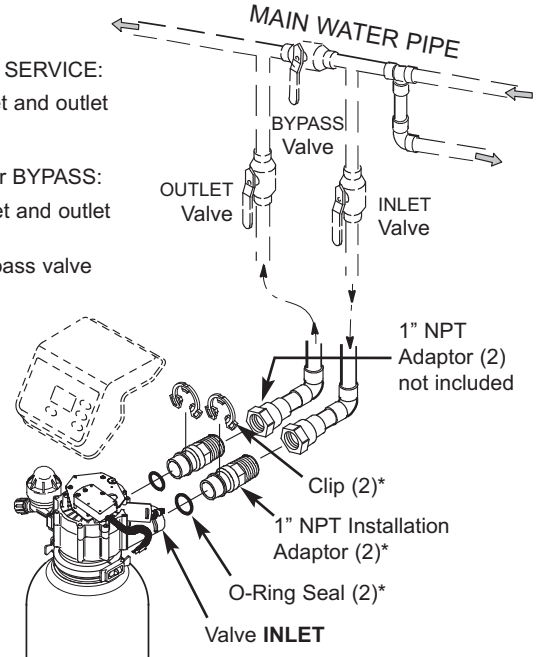

CONNECTING A RIGID VALVE DRAIN TUBE

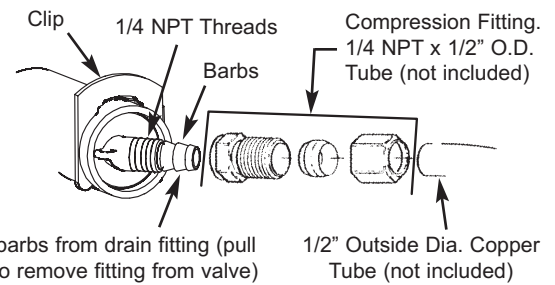

To standpipe, sump, laundry tub or other suitable drain.

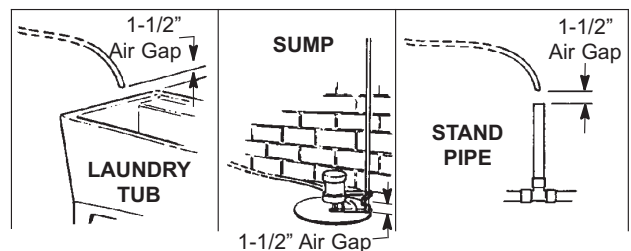

FIG. 4

1. TURN OFF WATER SUPPLY

- a. Close the main water supply valve near the well pump or water meter.
- b. Shut off the electric or fuel supply to the water heater.
- c. Open high and low faucets to drain all water from the house pipes.

2. INSTALL BYPASS VALVE AND/OR PLASTIC ADAPTORS:

- a. If installing a single bypass valve, push the bypass valve, with lubricated o-ring seals in place, into the valve inlet and outlet ports (See Figures 4 & 5).
- OR -
- b. If installing a 3-valve bypass system, slide plastic installation adaptors, with lubricated o-ring seals in place, into the valve inlet and outlet ports (See Figure 4 & 5).
- c. Be sure the turbine support is in place in the valve outlet, as shown in Figure 6.
- d. Snap the two large plastic clips in place on the inlet and outlet ports, from the top, down (See Figure 7). Be sure they snap into place. Pull on the bypass valve or plastic adaptors, to make sure they are held securely in place.

3. COMPLETE PLUMBING TO AND FROM THE SOFTENER

Using the “Typical Installation Illustration” on page 6 as a guide, observe all of the following cautions while you connect inlet and outlet plumbing:

- Be sure incoming, **hard water** is directed to the valve **INLET** port.
- Be sure to install bypass valve(s).
- If making a soldered copper installation, do all sweat soldering before connecting pipes to the softener fittings. Torch heat will damage plastic parts.
- Use pipe joint compound on all external pipe threads.
- When turning threaded pipe fittings onto plastic fittings, use care not to cross-thread.
- Support inlet and outlet plumbing in some manner (use pipe hangers) to keep the weight off of the valve fittings.

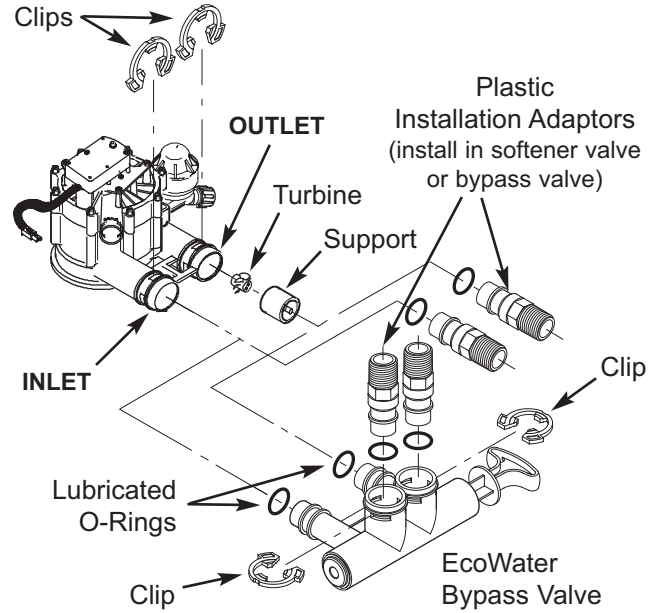

FIG. 5

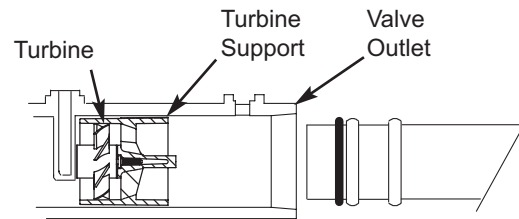
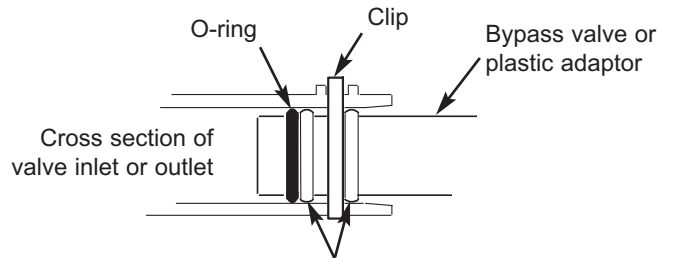
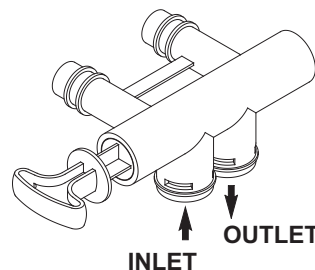

FIG. 6



Snap clips into place between larger diameter rings

FIG. 7



Turn the bypass valve downward if connecting to floor level plumbing

FIG. 8

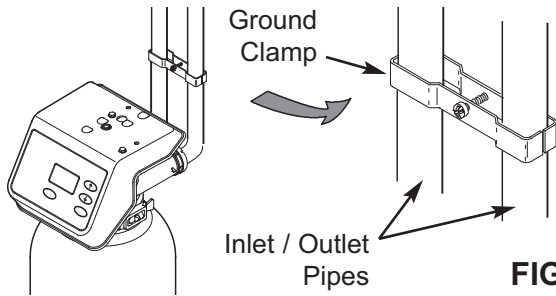

FIG. 9

4. COLD WATER PIPE GROUNDING

The house cold water pipe (metal only) is often used as a ground for the house electrical system. The 3-valve bypass type of installation, shown in Figure 4, will maintain ground continuity. If you use the plastic bypass, continuity is broken. To restore the ground, do either step 4a or 4b following.

- a. Use the EcoWater ground clamp kit (not included) to make a jumper across the inlet and outlet pipes (See Figure 9).
- b. Install a #4 copper wire across the removed section of main water pipe, securely clamping at both ends – parts not included.

5. INSTALL VALVE DRAIN HOSE

- a. Take a length of 1/2" inside diameter hose and attach to the valve drain fitting, securing it with a hose clamp (See Figure 4 on page 6).
- b. Locate the other end of the hose at a suitable drain point (floor drain, sump, laundry tub, etc.). Check and comply with local codes. Refer to Figure 4 on page 6 if codes require a rigid pipe drain run.

IMPORTANT: Use high quality, thick wall hose that will not easily kink or collapse. The softener will not backwash properly if water cannot exit this hose during recharges.

- c. Tie or wire the hose in place at the drain point. Water pressure will cause it to whip during the backwash portion of the recharge cycle. Also provide an air gap of at least 1-1/2" between the end of the hose and the drain point. An air gap prevents possible siphoning of sewer water, into the softener, if the sewer should back up.
- d. If raising the drain hose overhead is required to get to the drain point, do not raise higher than 8 feet above the floor. Elevating the hose may cause a back pressure that could reduce backwash flow and proper resin bed cleaning.

6. BRINE TANK ASSEMBLY

- a. Verify that the brinewell is positioned in the recess at the bottom of the brine tank and is attached to the side with a screw and washer.
- b. Make sure that the brine valve is sitting on the bottom inside the brinewell, with the brine tube exiting the brinewell through the top slot, just below the brinewell cover.
- c. Take the rubber grommet and hose adaptor elbow from the parts bag. Push grommet into the larger hole in the side wall of the brine tank. Then insert the larger diameter end of the elbow through the grommet.

7. INSTALL BRINE TANK OVERFLOW HOSE

This drain is for safety only. If the brine tank should over-fill with water, the excess is carried to the drain.

- a. Attach a length of 1/2" inside diameter hose to the drain elbow, installed in the previous step 2. Use a hose clamp to hold it in place.
- b. Locate the other end of the hose at the drain point. Do not elevate this hose higher than the elbow on the brine tank. Do not tee this hose to the valve drain hose.

8. CONNECT BRINE TUBING

- a. Route the brine tube out of the brine tank through the smaller hole in the tank side wall.
- b. Connect the brine tube to the nozzle/venturi assembly using the ferrule nut provided (See Figure 10).

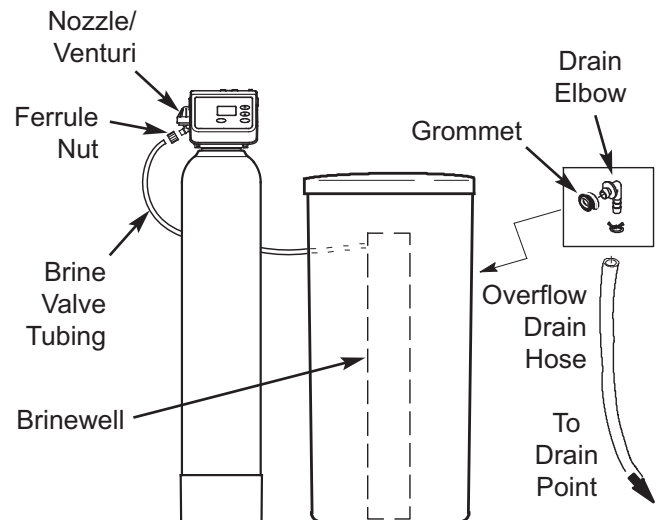

FIG. 10

9. PRESSURE TESTING FOR LEAKS, PROGRAMMING THE CONTROLLER & RINSING THE MEDIA

To prevent excessive air pressure in the water softener and plumbing system, do the following steps **EXACTLY** in order:

- a. Fully open two or more **softened** cold water faucets nearby the water softener.
- b. Place the bypass valve(s) in **bypass** position (See Figures 2 & 4).
- c. Fully open the main water supply valve. Watch until the flow from the opened faucets becomes steady, with no spurting or air bubbles.
- d. After about three minutes, open a hot water faucet for one minute, or until all air is expelled.
- e. Close all faucets and check your plumbing work for leaks.
- f. Make sure the softener's valve drain hose is hooked up and the open end directed to a floor drain, laundry tub or other suitable type of drain.
- g. Make sure the softener's bypass valve is in the **bypass** position.
- h. Plug in the power supply.
- i. **Program the electronic controller:** Follow the steps on Pages 10 and 11 to program the electronic controller with basic operating information, such as time and water hardness. After completing these steps, continue with "j. Start a recharge", below.
- j. **Start a recharge:** Press the RECHARGE button and hold for 3 seconds, until "Recharge Now" flashes in the display and you hear the valve motor run as the softener begins recharging.
- k. Once the unit is in backwash, place bypass valve(s) into the **service** position, as follows:
 - (1) SINGLE BYPASS VALVE: **Slowly** move the valve stem toward **service** position, pausing several times to allow the unit to pressurize slowly.
 - (2) 3-VALVE BYPASS: Fully close the **bypass** valve and open the **outlet** valve. **Slowly** open the **inlet** valve, pausing several times to allow the unit to pressurize slowly.
- l. Let the softener complete the backwash and fast rinse cycles (takes 10-12 minutes). When the recharge cycle ends, the softener valve returns to the service position.

10. ADD WATER AND SALT TO THE BRINE TANK

- a. Using a pail or garden hose, add about 3 gallons of water into the brine tank. **DO NOT** pour into the brinewell.
- b. Add salt to the brine tank. It is recommended to fill the brine tank no more than 1/2 full. Level the salt when finished adding. You can use most water softener salts, but it must be clean. Recommended nugget, pellet or coarse solar salts have less than 1% impurities.

NOTE: See page 14 for additional information on salt.

11. SANITIZING THE WATER SOFTENER

Care is taken at the factory to keep your EcoWater Systems water softener clean and sanitary. However, during shipping, storage, installing and operating, bacteria could get into the unit. For this reason, sanitizing as follows is suggested* when installing.

- a. Remove the brinewell cover and pour about 1-1/2 oz. (2 to 3 tablespoons) of common household bleach into the softener's brinewell. Replace the brinewell cover.
- b. Make sure the bypass valve is in the **service** position.
- c. **Start a recharge:** Press the RECHARGE button and hold for 3 seconds, until "Recharge Now" flashes in the display and you hear the valve motor run as the softener begins recharging. This recharge draws the sanitizing bleach into and through the softener. Any air remaining in the unit is purged to the drain.
- d. After the recharge has completed, fully open a cold water faucet, downstream from the softener, and allow 50 gallons of water to pass through the system. This should take at least 20 minutes. Close the faucet.

12. RESTART THE WATER HEATER

Turn on the electric or fuel supply to the water heater, and light the pilot, if applies.

NOTE: The water heater is filled with hard water and, as hot water is used, it refills with softened water. In a few days, the hot water will be fully conditioned. To have fully conditioned hot water immediately, wait until the recharge (Step 11) is complete, then drain the water heater until water runs cold.

*Recommended by the Water Quality Association. On some water supplies, the EcoWater Systems unit may need periodic disinfecting.

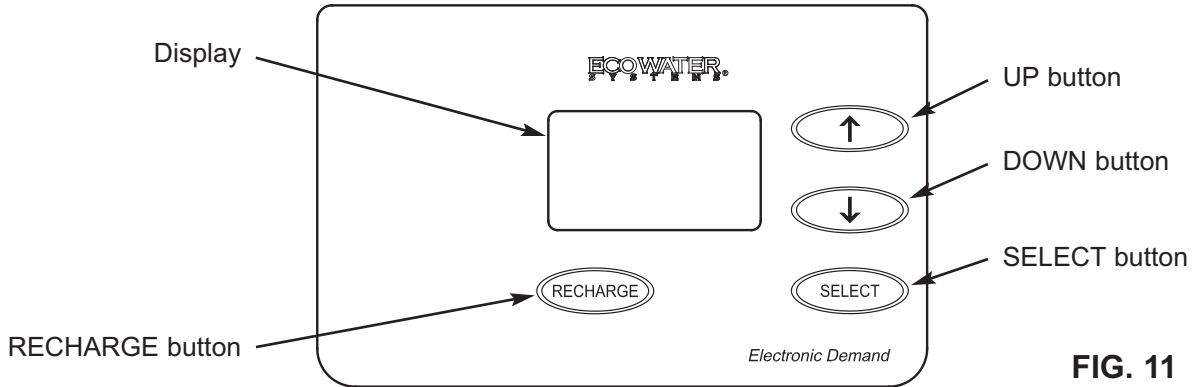

FIG. 11

CONTROLLER SETTINGS REQUIRED

upon installation, and after an extended power outage.

When the power supply is plugged into the electrical outlet, a model code (“EC25” for Model EEC 1502R25 or “EC40” for Model EEC 1502R40) and a test number (example: J3.8), are briefly shown in the display. Then the words “PRESENT TIME” appear and 12:00 PM begins to flash.

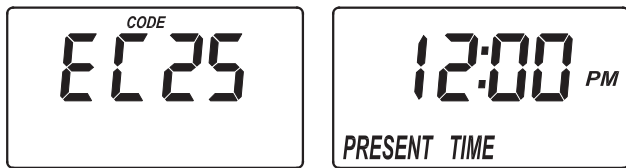

FIG. 12

A. SET PRESENT TIME OF DAY

If the words “PRESENT TIME” do not show in the display, press the SELECT button several times until they do.

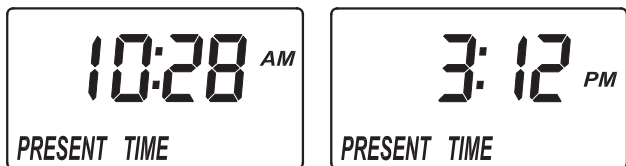

FIG. 13

1. Press the ↑ UP or ↓ DOWN buttons to set the present time. Up moves the display ahead; down sets the time back. Be sure AM or PM is correct.

NOTE: Press buttons and quickly release to slowly advance the display. Hold the buttons down for fast advance.

2. When the correct time is displayed, press the SELECT button, and the display will change to show the “Hardness” screen.

B. SET WATER HARDNESS NUMBER

1. If you completed the previous step, the word “HARDNESS” should show in the display (See Figure 14). Otherwise, press the SELECT button several times until it does.



FIG. 14

2. Press the ↑ UP or ↓ DOWN buttons to set the value of your water’s hardness in grains per gallon (gpg).

NOTE: If your water supply contains iron, compensate for it by adding to the water hardness number. For example, assume your water is 20 gpg hard and contains 2 ppm iron. Add 5 to the hardness number for each 1 ppm of iron. In this example, you would use 30 for your hardness number.

$$\begin{array}{r}
 20 \text{ gpg hardness} \\
 2 \text{ ppm iron} \times 5 = 10 \quad +10 \\
 \text{(times)} \qquad \qquad \qquad 30 \text{ HARDNESS NUMBER}
 \end{array}$$

2. When finished setting your water’s hardness number, press the SELECT button, and the display will change to show the “Recharge Time” screen.

C. SET REGENERATION STARTING TIME

1. If you completed the previous step, the words “RECHARGE TIME” should show in the display (See Figure 15). Otherwise, press the SELECT button several times until they do.

continued on next page

continued from previous page

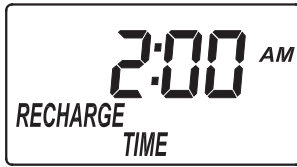

FIG. 15

2. The softener's default regeneration start time is 2:00 AM. In most households this is a good time

for regeneration to start (takes about 2 hours) because water is not being used. During regeneration hard water is bypassed to house faucets. Use the \uparrow UP or \downarrow DOWN buttons to adjust the recharge start time in 1 hour increments.

3. When the desired regeneration time is displayed, press the SELECT button, and the display will change to show the normal run time display.

CONTROLLER FEATURES / OPTIONS

NORMAL OPERATION

During normal operation, the present time of day shows in the display.



FIG. 16

POWER OUTAGE MEMORY

If electrical power to the softener's control is lost, internal memory will maintain most settings such as the hardness and recharge time. However, unless the power outage was very brief, the clock's present time will need to be reset. During a power outage, the display will be blank and the softener will not recharge. When electrical power is restored:

1. Check the display.
- 2a. If the present time is displayed steadily (not flashing), the controller did not lose time and you do not need to reset the clock.
- 2b. If a time is flashing in the display, then the clock needs to be reset to the correct present time. See "Set Present Time of Day" on page 10. The flashing display is to remind you to reset the clock. If you do not reset the clock, then recharges will most likely occur at the wrong time of day.

NOTE: If the softener was regenerating when power was lost, it will finish the cycle when power returns.

RECHARGE NOW

For times when you expect to use more water than usual, it may be desirable to perform a manually initiated regeneration. To manually start a regeneration cycle, press and hold the RECHARGE button for a few seconds, until "RECHARGE NOW" flashes in the display.



FIG. 17

The softener begins an immediate regeneration. Once started, you cannot cancel this regeneration. Avoid using hot water during this time, as the water heater will refill with hard water.

RECHARGE TONIGHT

To set a regeneration cycle to begin at the next preset regeneration time, touch (press, but do not hold) the RECHARGE button. "RECHARGE TONIGHT" flashes in the display.

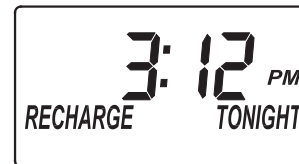

FIG. 18

A regeneration will begin at the next preset regeneration start time (2:00 AM or as set). If you decide to cancel this regeneration before it starts, touch the same button once more.

VACATION NOTE

EcoWater demand controlled water softeners regenerate only while water is being used and softening capacity must be restored. For this reason, the unit will not regenerate when you are away from home for extended periods.

SALT EFFICIENCY

When this feature is ON, the water softener will operate at salt efficiencies of 4000 grains of hardness per pound of salt or higher (May recharge more often using smaller salt dosage and less water). The softener is shipped with this feature set OFF.

1. Press and hold for 3 seconds the SELECT button, until the display shows "000 - -" (See Figure 19).



FIG. 19

2. Once in this display, press the SELECT button once and one of the two displays in Figure 20 is shown.
3. Press the ↑ UP or ↓ DOWN buttons to set ON or OFF. When set to ON, the efficiency icon will be displayed in the upper right hand corner of the normal run display.

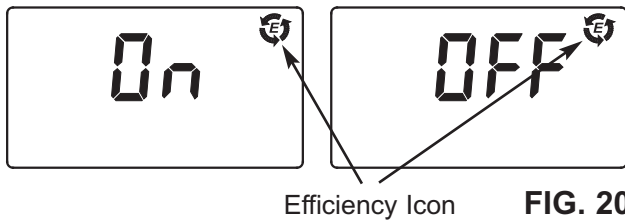

FIG. 20

4. Press the SELECT button twice to return to the normal run display (See Figure 21).

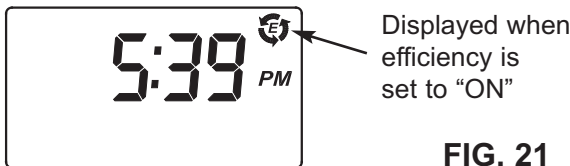

FIG. 21

In the state of California: You must turn the Salt Efficiency Feature ON. This may initiate more frequent recharges. However, it will operate at 4,000 grains per pound of salt or higher.

AUXILIARY OUTPUT CONTROL

The electronic controller's auxiliary output may be used to operate various types of external equipment, such as a chlorine generator or chemical feeder. It provides a 24V DC, up to 500 mA, current from terminal J4 on the electronic control board (see Schematic on Page 17). The table below explains the choices available for when the auxiliary output will be on during various portions of the recharge cycle:

SELECTION	NAME	AUXILIARY OUTPUT FUNCTION
OFF	Off	Remains off indefinitely.
BP	Bypass	On during the entire recharge.
CL	Chlorine	On during the brine draw portion of the recharge.
FS	Flow Switch	On when water is flowing past the turbine. It will shut off 8 seconds after water flow stops.
CF	Chemical Feeder	After the set volume of water has flowed past the turbine, turns on for the time set (see Steps 4 & 5, on the next page, to set volume and time).
FR	Fast Rinse	On during the fast rinse portion of the recharge.

The default is OFF. If you wish to change to one of the other selections shown in the table above:

1. Press and hold the SELECT button until "000 - -" shows in the display (See Figure 19).
2. Press the SELECT button twice and "Ctrl" will flash in the display.

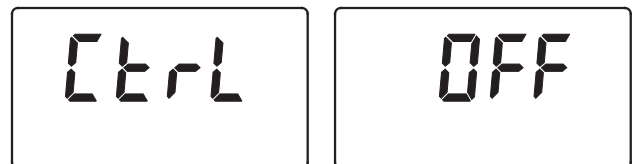

FIG. 22

3. Use the ↑ UP or ↓ DOWN buttons to display the desired selection, then press the SELECT button. If you selected anything other than CF, the display will return to the normal run (time of day) screen. If setting to CF (Chemical Feeder), there will be two additional settings to make for operating the chemical feeder in Steps 4 and 5, on the next page.

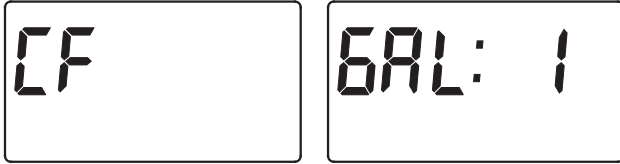

FIG. 23

4. CHEMICAL FEEDER TRIP VOLUME: If you have set the auxiliary output control to CF (Chemical Feeder), you will need to set the volume of water which must flow past the turbine before the auxiliary output is turned on. With the alternating screens in Fig. 23 shown, use the ↑ UP or ↓ DOWN buttons to set the trip volume, in gallons.

Then press the SELECT button to display the screen shown in Fig. 24.



FIG. 24

5. CHEMICAL FEEDER TIME: Use the ↑ UP or ↓ DOWN buttons to set the length of time, in seconds, that the auxiliary output will be turned on. Then press the SELECT button to accept and return to the normal run (time of day) screen.

ROUTINE MAINTENANCE

CLEANING THE NOZZLE & VENTURI

A clean nozzle & venturi (See Figure 25) is a necessity for the water softener to work properly. This small component creates the suction to aspirate (bring air into) the mineral tank during recharges. If it should become plugged with sand, silt, dirt, etc., the water softener will not work, and hard water will result.

To get access to the nozzle & venturi, remove the water softener's top cover. Put the bypass valve(s) into the bypass position. Be sure the water softener's main valve is in "service" position (no water pressure at nozzle & venturi). Then, holding the nozzle & venturi housing with one hand, unscrew the cap. Do not lose the o-ring seal. Lift out the screen support and screen. Then, remove the nozzle & venturi disc, gasket and flow plug. Wash the parts in warm, soapy water and rinse in fresh water. Be sure to clean both the top and bottom of the nozzle & venturi disc. If needed, use a small brush to remove iron or dirt. Do not scratch, misshape, etc., surfaces of the nozzle & venturi.

Gently replace all parts in the correct order. Lubricate the o-ring seal with silicone grease and locate in place. Install and tighten the cap by hand, while supporting the housing. Overtightening may break the cap or housing. Put the bypass valve(s) into "service" position.

Recharge the softener to reduce water level in the tank. This will also assure that the softener is completely recharged and ready to provide softened water again. Check the water level in the tank by looking down the brinewell. If the water level does not drop after a recharge, the problem has not been resolved.

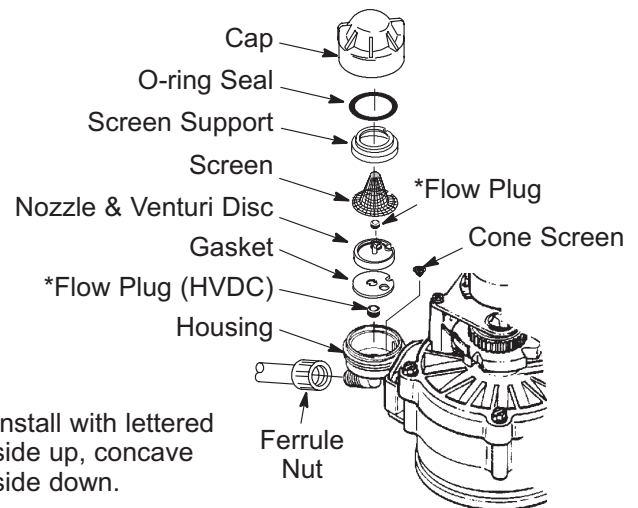

IMPORTANT: Be sure small hole in the gasket is centered directly over the small hole in the nozzle & venturi housing. Be sure the numbers are facing up

FIG. 25

RESIN BED CLEANING

If the water supply contains clear water iron, regular resin bed cleaning is needed to keep the bed from coating with iron. Use resin bed cleaner, available from EcoWater Systems, following directions on the container. Clean the resin every six months, or more often if iron appears in the conditioned water supply.

REFILLING WITH SALT

If the softener uses all the salt before more is added, hard water will result. Remove the brine tank lid and check the salt level frequently. Until you have established a refilling routine, check the salt every 2 or 3 weeks. Be sure that the brinewell cover is on when adding salt.

NOTE: In humid areas it is best to keep the salt level less than half full and refill more often.

RECOMMENDED SALT: Cube, pellet, coarse solar, etc., water softener salt is recommended. This type of salt is high purity evaporated crystals, sometimes formed and pressed into briquets. It has less than 1% insoluble (not dissolvable in water) impurities. Clean, high grade rock salts are acceptable, but may require frequent brine tank cleaning to remove the "sludge" residue (insolubles) collecting at the bottom of the tank.

POTASSIUM CHLORIDE: If you choose potassium chloride (KCl) salt instead of standard sodium chloride (NaCl) water softener salt as a regenerant:

- 1) The hardness setting must be increased by 25%.
- 2) Place only one bag of potassium chloride (KCl) into your water softener at a time. The salt storage tank should never contain more than 60 pounds of KCl.

SALT NOT RECOMMENDED: Rock salt high in impurities, block, granulated, table, ice melting, or ice cream making salts, etc., are not recommended.

SALT WITH IRON REMOVING ADDITIVE: Some salts have an additive to help a water softener handle iron in the water supply. Although this may help keep the resin bed clean, it may also release corrosive fumes that will weaken and shorten the life of some EcoWater Systems softener electronic parts. Iron Out salt is safe to use on two-tank models.

BREAKING A SALT BRIDGE

Sometimes a hard crust or salt "bridge" forms in the brine tank. This is usually caused by high humidity or the wrong kind of salt. When the salt bridges, an empty space forms between the water and the salt. Then salt will not dissolve in the water to make brine. Without brine, the resin bed is not recharged and hard water will result.

If the storage tank is full of salt, it is difficult to tell whether there is a salt bridge. A bridge may be underneath loose salt. The following is the best way to check for a salt bridge:

Salt should be loose all the way to the bottom of the tank. Hold a broom handle, or like tool, up to the softener's brine tank, as shown in Figure 26. Make a pencil mark on the handle 1" - 2" below the top of the rim. Then, carefully push it straight down into the salt. If a hard object is felt before the pencil mark is even with the top, it is most likely a salt bridge. Carefully push into the bridge in several places to break it. **Do not try to break the salt bridge by pounding on the outside of the salt tank. You may damage the tank.**

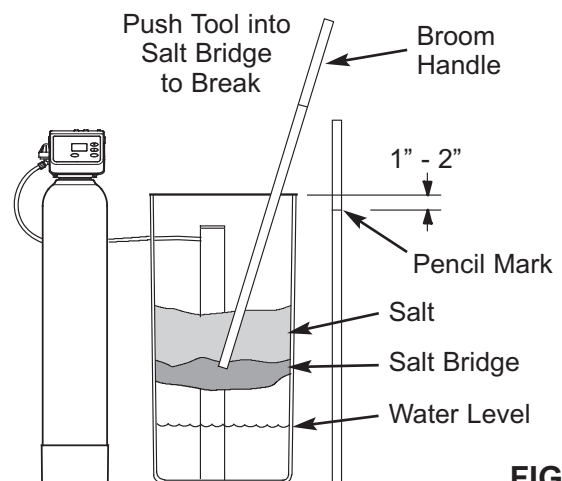

FIG. 26

AUTOMATIC ELECTRONIC DIAGNOSTICS

This softener has a self-diagnostic function for the electrical system. The computer monitors electronic components and circuits for correct operation. If a malfunction occurs, an error code appears in the display.



FIG. 27

The chart below shows the error codes that could appear, and the possible malfunctions for each code.

Code	Possible Problems
Err01	Motor, Valve Position Switch
Err03	Motor, Valve Position Switch, Wire Harness
Err04	Valve Position Switch
Err05	Electronic Control Board (PWA)

While an error code appears in the display, all buttons are inoperable except the SELECT button. SELECT remains operational so the service person can perform the Manually Initiated Electronic Diagnostics to further isolate the problem.

TO REMOVE AN ERROR CODE:

1. Unplug the power supply.
2. Correct the problem.
3. Plug the power supply back in.
4. Wait for at least 8 minutes while the timer operates the valve through an entire cycle. The error code will return if the problem was not corrected.

MANUALLY INITIATED ELECTRONIC DIAGNOSTICS

Use the following procedures to advance the softener through the recharge cycles to check operation.

Remove the 2 screws holding the faceplate assembly on top of the valve and lift the faceplate away from the valve, to observe cam and switch operation during valve rotation (See Figure 29).

1. Press and hold for 3 seconds the SELECT button, until one of the screens shown in Figure 28 is displayed. If the valve is in service, fill, brining, backwash or fast rinse position (observe markings on the valve cam), the display should show "000 - -", meaning the position switch is open. When the valve is moving, the display should show "000 - P", meaning that the position switch is closed.

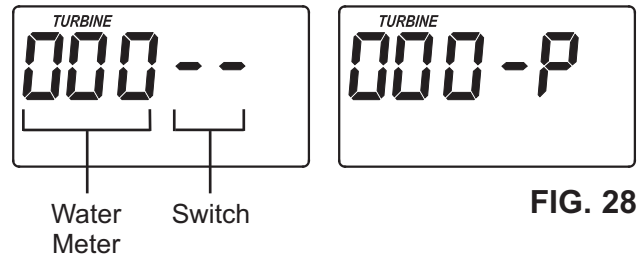

FIG. 28

2. The first 3 digits of the display in Figure 28 should count upward whenever water is flowing through the system.
3. Use the RECHARGE button to manually advance the valve into each position and check correct switch operation (See Figures 31-35).

continued on the next page

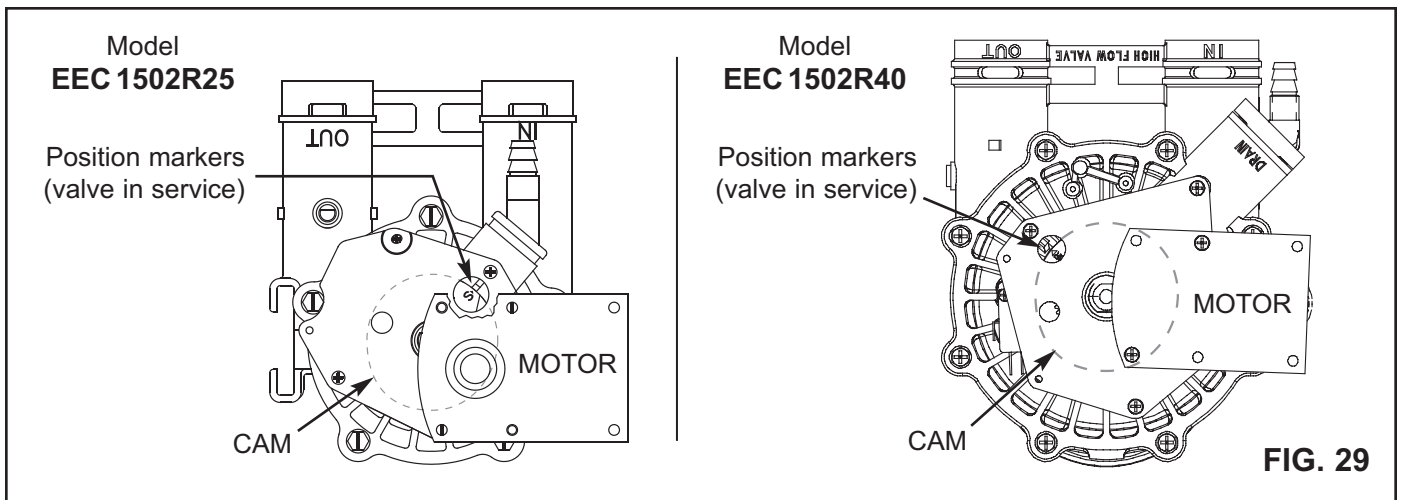

FIG. 29

continued from previous page

4. While in this diagnostic screen, the following information is available and may be beneficial for various reasons. This information is retained by the computer from the first time electrical power is applied to the electronic controller.
 - a. Press the **↑ UP** button to display the number of days this electronic control has had electrical power applied.
 - b. Press the **↓ DOWN** button to display the number of automatic or manual recharges initiated by this electronic control since the model code number was entered.
5. Press the **SELECT** button and hold in for 3 seconds until the model code shows in the display. The model code should be "EC25" for Model EEC 1502R25 or "EC40" for Model EEC 1502R40. If the wrong number shows, the softener will operate on incorrect configuration data.
6. To change the code number - Press the **↑ UP** or **↓ DOWN** button until the correct code shows.
7. To return to the present time display, press the **SELECT** button. **If the model code was changed, make all controller settings.**

NOTE: If the electronic control is left in a diagnostic display (or a flashing display when setting times or hardness), present time automatically returns if a button is not pressed within 4 minutes.

RESETTING TO FACTORY DEFAULTS

To reset the electronic controller to its factory default for all settings (time, days between recharges, etc.):

1. Press the **SELECT** button and hold it until the display changes twice to show "CODE" and the flashing model code.
2. Press the **↑ UP** button (a few times, if necessary) to display a flashing "SoS".

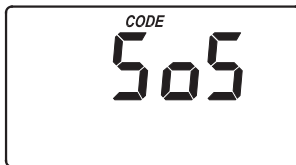
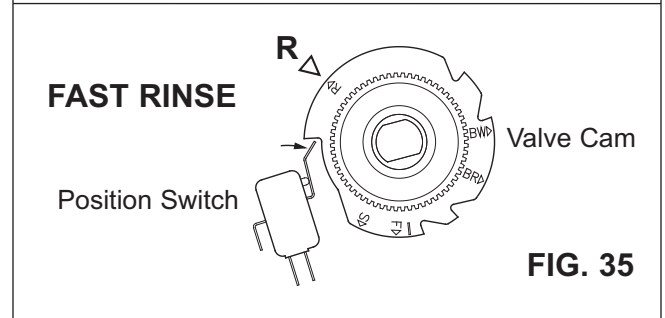
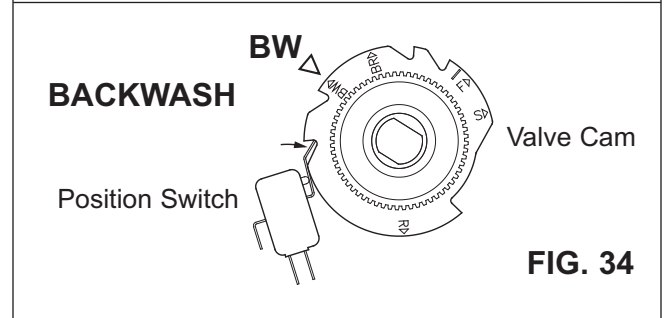
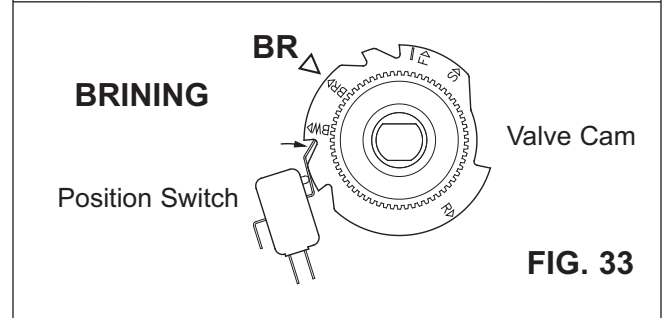
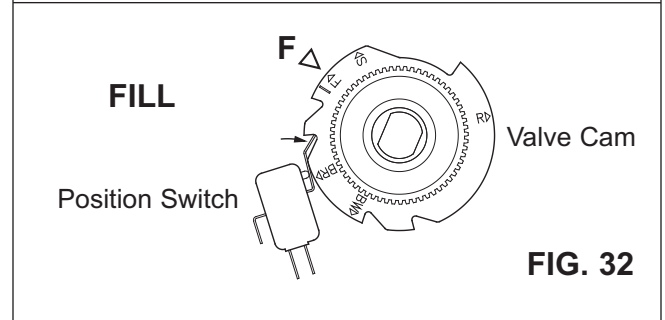
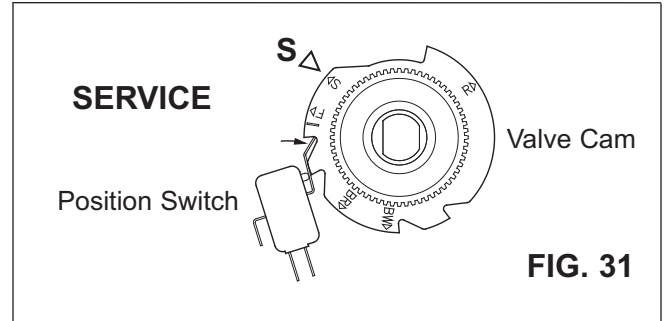

FIG. 30

3. Press the **SELECT** button, and the electronic controller will restart.
4. Set the present time, days between recharges, etc., as described on pages 10 & 11.



WIRING SCHEMATIC

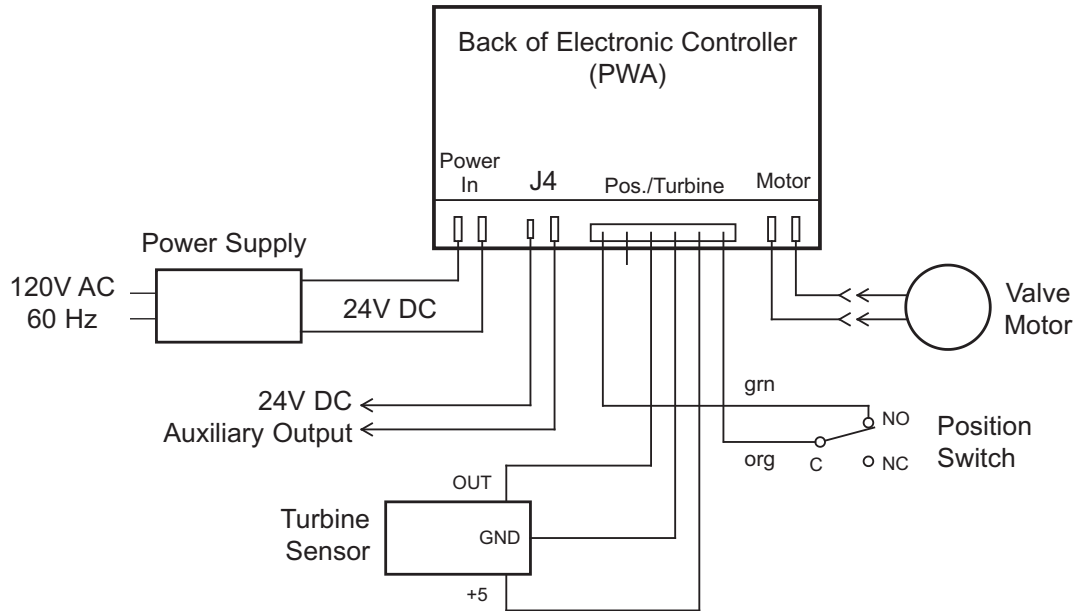
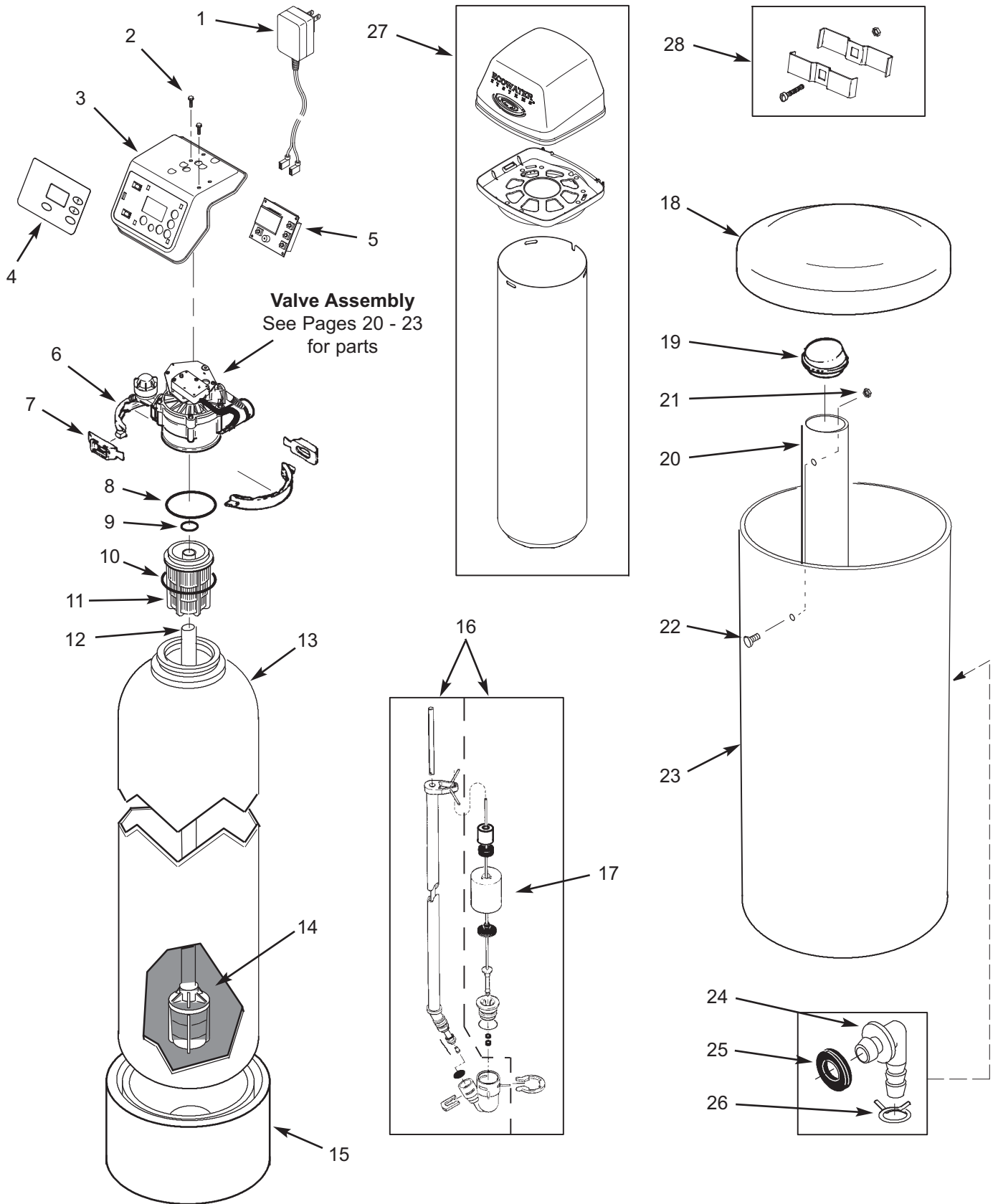

FIG. 36

SOFTENER EXPLODED VIEW – EEC 1502R25 & EEC 1502R40



SOFTENER PARTS LIST – EEC 1502R25 & EEC 1502R40

Key No.	Part No.	Description
1	7351054	Power Supply, 24V DC
2	7345655	Screw, #10-14 x 3/4" (2 req.)
3	7345435	Faceplate (order decal below)
4	7345613	Decal, Faceplate
5	7349421	Repl. Electronic Controller (PWA)
–	7331177	Tank Neck Clamp Kit (includes 2 ea. of Key Nos. 6 & 7)
6	↑	Clamp Section (2 req.)
7	↑	Retainer, Clamp (2 req.)
–	7112963	Distributor O-Ring Kit (includes Key Nos. 8-10)
8	↑	O-Ring, 2-7/8" x 3-1/4"
9	↑	O-Ring, 13/16" x 1-1/16"
10	↑	O-Ring, 2-3/4" x 3"
11	7077870	Top Distributor
12	7327584	Repl. Bottom Distributor
13	7113058	Repl. Resin Tank, 8" x 40", Model EEC 1502R25
	7161849	Repl. Resin Tank, 9" x 40" Model EEC 1502R25
14	0502272	Resin, 1 cu. ft. (standard mesh)

Key No.	Part No.	Description
15	1183000	Tank Foot, 8", Model EEC 1502R25
	7226039	Tank Foot, 9", Model EEC 1502R40
16	7310210	Brine Valve Assembly
17	7327568	Float, Stem & Guide Assembly
18	7345663	Cover, Brine Tank
19	7155115	Cover, Brinewell
20	7109871	Brinewell
–	7331698	Brinewell Mounting Hardware Kit (includes Key Nos. 21 & 22)
21	↑	Washer
22	↑	Screw
23	7362306	Brine Tank
–	7331258	Overflow Hose Adaptor Kit (includes Key Nos. 24-26)
24	↑	Adaptor Elbow
25	↑	Grommet
26	↑	Hose Clamp *
27	7346724	Shroud Kit *
28	7248706	Ground Clamp Kit *

* Optional parts, not included with softener

To order parts, call your local EcoWater dealer or go to
www.ecowater.com to locate a dealer in your area.

VALVE EXPLODED VIEW – EEC 1502R25

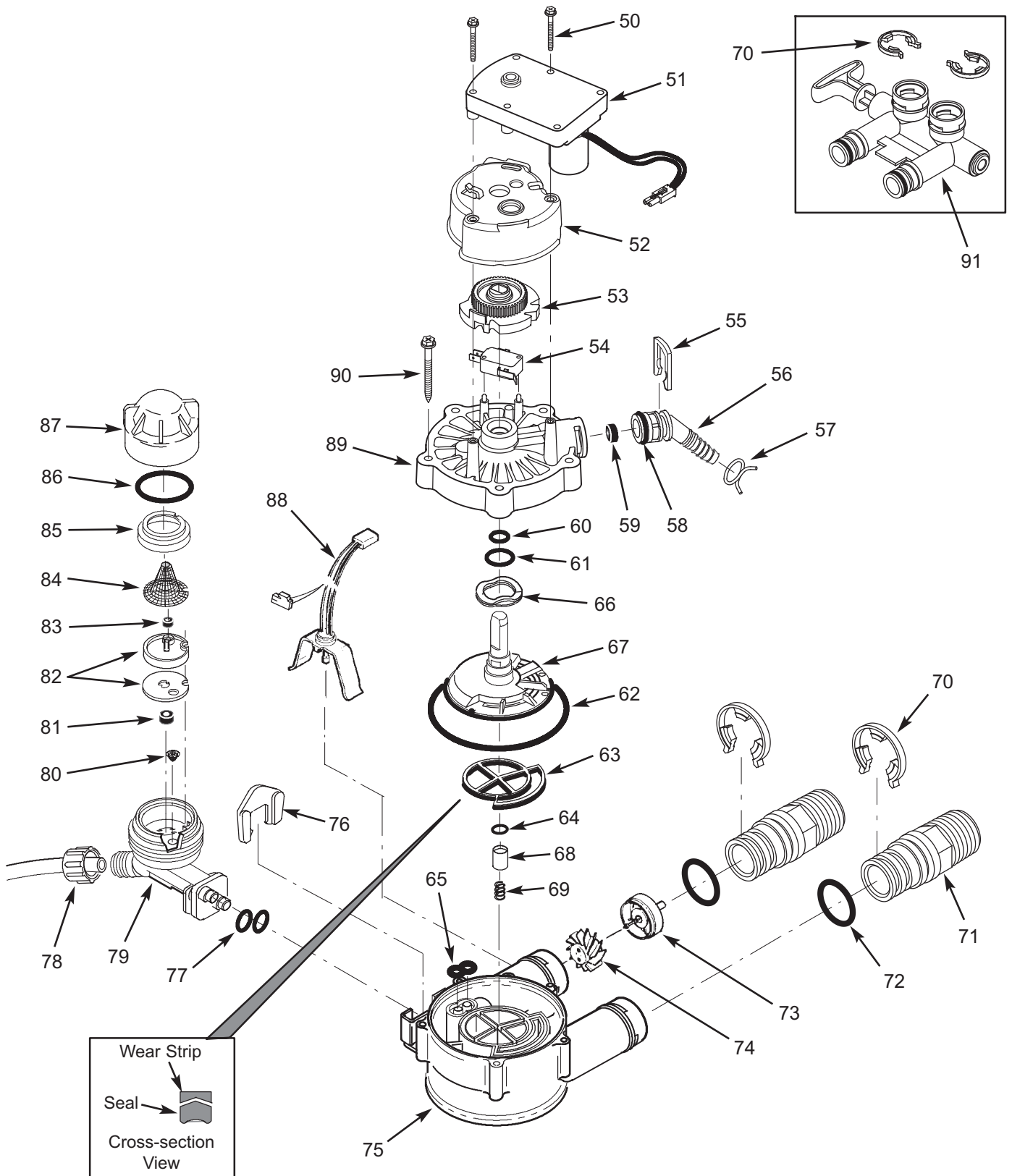

VALVE PARTS LIST – EEC 1502R25

Key No.	Part No.	Description
50	7338111	Screw, #6-19 x 1-3/8" (2 req.)
51	7281291	Motor
52	7337474	Motor Mount
53	7284964	Cam & Gear
54	7030713	Switch
–	7331185	Drain Hose Adaptor Kit (includes Key Nos. 55-59)
55	↑	Clip, Drain
56	↑	Drain Hose Adaptor
57	↑	Hose Clamp
58	↑	O-Ring, 5/8" x 13/16"
59	↑	Flow Plug, 2.0 gpm
–	7129716	Seal Kit (includes Key Nos. 60-65)
60	↑	O-Ring, 7/16" x 5/8"
61	↑	O-Ring, 3/4" x 15/16"
62	↑	O-Ring, 3-3/8" x 3-5/8"
63	↑	Rotor Seal
64	↑	O-Ring, 3/8" x 9/16"
65	↑	Seal, Nozzle & Venturi
66	7082087	Wave Washer
67	7199232	Rotor & Disc
68	7092642	Plug, Drain Seal
69	7129889	Spring
70	7116713	Clip, 3/4", single (2 req.)
	7336397	Clip, 3/4", pack of 20
71	7278442	Installation Adaptor, 3/4", single (2 req.)
	7336606	Installation Adaptor, 3/4", pack of 10 (includes 10 ea. of Key No. 72)

Key No.	Part No.	Description
72	7170288	O-Ring, 15/16" x 1-3/16", single (2 req.)
	7336402	O-Ring, 15/16" x 1-3/16", pack of 20
–	7113040	Turbine & Support Assembly (includes 1 ea. of Key Nos. 73, 74 & 2 ea. of Key No. 72)
73	↑	Turbine Support & Shaft
74	↑	Turbine
75	7082053	Valve Body
76	7081201	Retainer, Nozzle & Venturi
77	7170319	O-Ring, 1/4" x 3/8" (2 req.)
78	1202600	Nut - Ferrule
–	7238450	Nozzle & Venturi Assembly (incl. Key Nos. 76, 77 & 79-87)
79	7081104	Housing, Nozzle & Venturi
80	7095030	Cone Screen
81	1148800	Flow Plug, .3 gpm
82	7187772	Nozzle & Venturi Kit w/Gasket
	7204362	Gasket only, single
	7336486	Gasket only, pack of 20
83	0521829	Flow Plug, .1 gpm
84	7146043	Screen
85	7167659	Screen Support
86	7170262	O-Ring, 1-1/8" x 1-3/8", single
	7336436	O-Ring, 1-1/8" x 1-3/8", pack of 20
87	7199729	Cap
88	7309803	Wire Harness, Sensor
89	7337466	Valve Cover
90	7074123	Screw, #10-14 x 2" (5 req.)
91	7278434	Bypass Valve Assembly, 3/4" * (includes 2 ea. of Key No. 72)

* Optional parts, not included with softener.

To order parts, call your local EcoWater dealer or go to www.ecowater.com to locate a dealer in your area.

VALVE EXPLODED VIEW – EEC 1502R40

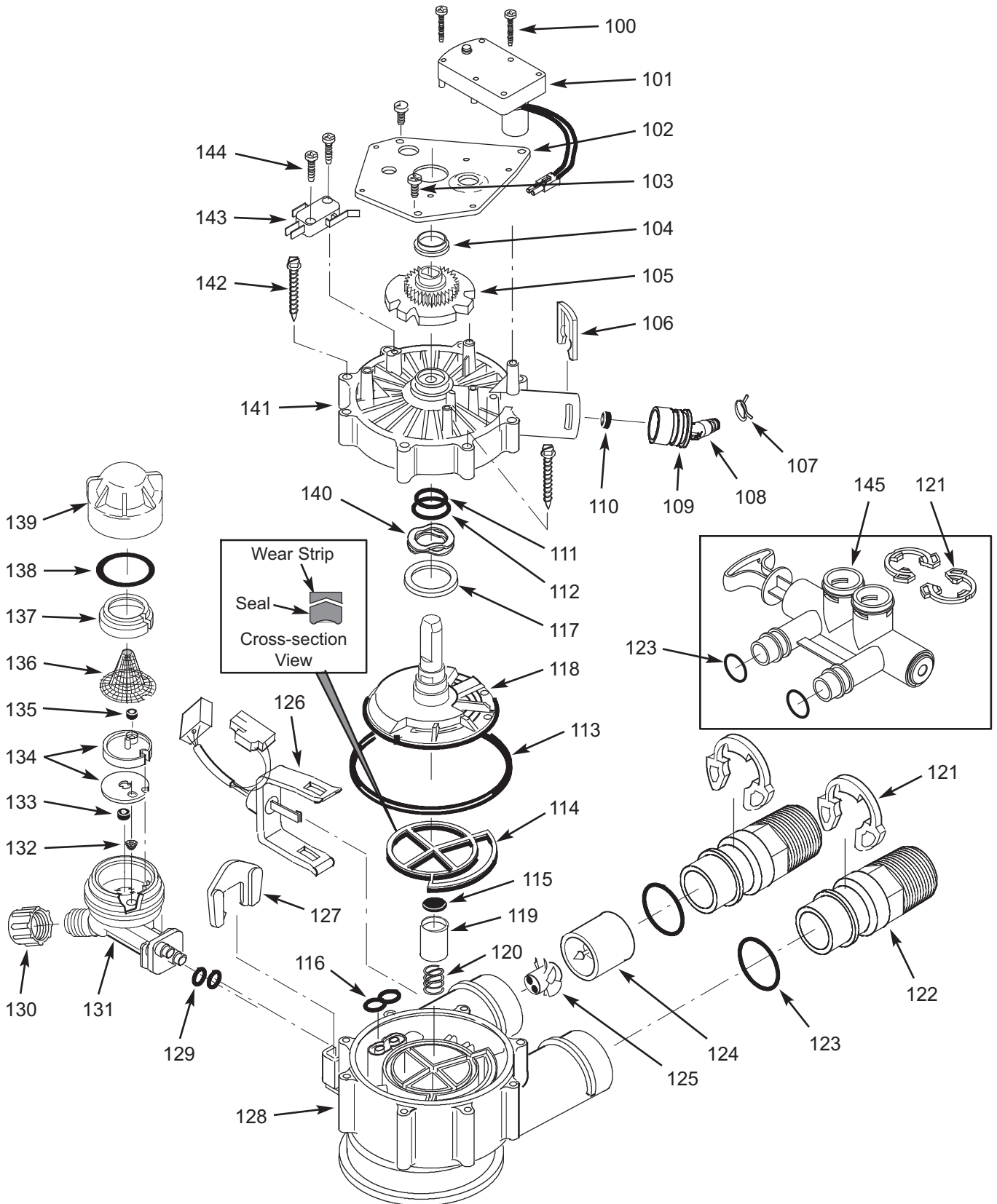

VALVE PARTS LIST – EEC 1502R40

Key No.	Part No.	Description
100	7224087	Screw, #8-32 x 1" (2 req.)
101	7286039	Motor (incl. 2 ea. of Key No. 100)
102	7231393	Motor Plate
103	0900857	Screw, #6-20 x 3/8" (3 req.)
104	7171250	Bearing
105	7283489	Cam & Gear
–	7331169	Drain Hose Adaptor Kit (incl. Key Nos. 106-110)
106	↑	Clip, Drain
107	↑	Hose Clamp
108	↑	Drain Hose Adaptor
109	↑	O-Ring, 15/16" x 1-3/16"
110	↑	Flow Plug, 2.0 gpm
–	7185487	Seal Kit (includes Key Nos. 111-116)
111	↑	O-Ring, 5/8" x 13/16"
112	↑	O-Ring, 1-1/8" x 1-1/2"
113	↑	O-Ring, 4-1/2" x 4-7/8"
114	↑	Rotor Seal
115	↑	Seal
116	↑	Seal, Nozzle & Venturi
117	7174313	Bearing, Wave Washer
118	7185500	Rotor & Disc
119	7171187	Plug, Drain Seal
120	7129889	Spring
121	7089306	Clip, 1", single (2 req.)
	7336428	Clip, 1", pack of 20
122	7271204	Installation Adaptor, 1", single (2 req.)
	7336614	Installation Adaptor, 1", pack of 10 (includes 10 ea. of Key No. 123)
123	7311127	O-Ring, 1-1/16" x 1-5/16", single (2 req.)
	7336410	O-Ring, 1-1/16" x 1-5/16", pack of 20

Key No.	Part No.	Description
–	7290931	Turbine & Support Assembly (includes 1 ea. of Key Nos. 124, 125 & 2 ea. of Key No. 123)
124	↑	Turbine Support & Shaft
125	↑	Turbine
126	7309811	Wire Harness, Sensor
127	7081201	Retainer, Nozzle & Venturi
128	7171145	Valve Body
129	7270319	O-Ring, 1/4" x 3/8" (2 req.)
130	1202600	Nut - Ferrule
–	7257454	Nozzle & Venturi Assembly (incl. Key Nos. 127, 129 & 131-139)
131	7081104	Housing, Nozzle & Venturi
132	7095030	Cone Screen
133	1148800	Flow Plug, .3 gpm
134	7114533	Nozzle & Venturi Kit w/Gasket
	7204362	Gasket only, single
	7336486	Gasket only, pack of 20
135	7084607	Flow Plug, .15 gpm
136	7146043	Screen
137	7167659	Screen Support
138	7170262	O-Ring, 1-1/8" x 1-3/8", single
	7336436	O-Ring, 1-1/8" x 1-3/8", pack of 20
139	7199729	Cap
140	7175199	Wave Washer
141	7171161	Valve Cover
142	7172997	Screw, #10 x 2-5/8" (8 req.)
143	7305150	Switch
144	7140738	Screw, #4-24 x 3/4" (2 req.)
145	7214383	Bypass Valve, 1" * (includes 2 ea. of Key Nos. 121 & 123)

* Optional parts, not included with softener.

To order parts, call your local EcoWater dealer or go to www.ecowater.com to locate a dealer in your area.

LIMITED WARRANTY

EcoWater Systems LLC Advantage Warranty EEC1502R25 & EEC1502R40 Water Conditioning Systems

Congratulations! You have just purchased the highest quality water conditioning product on the market.

To whom is this warranty extended?

EcoWater Systems LLC warrants its products to the original owner and guarantees that the products will be free from defects in materials and workmanship from the original date of installation.

How does my warranty work?

If, during the respective warranty period, a part proves, after inspection by EcoWater, to be defective, EcoWater will, at its sole option repair or replace that part at no charge, other than normal shipping, installation or service charges.

What is covered by the warranty?

EcoWater Systems LLC guarantees that,
for a period of TEN (10) YEARS after installation, the MINERAL TANK will not rust, corrode, leak, burst, or in any other manner fail to perform its proper functions and that,
for a period of FIVE (5) YEARS after installation, the SALT TANK will be free of defects in materials and workmanship and will perform its proper function and that,
for a period of ONE (1) YEAR after installation, the VALVE BODY, ELECTRONIC FACEPLATE and ALL OTHER PARTS will be free of defects in materials and workmanship and will perform their normal functions.

How do I obtain warranty service?

Should you need service, your local, independent EcoWater Dealer is only a phone call away.

PHONE: _____

To obtain warranty service, notice must be given, within thirty (30) days of the discovery of the defect, to your local EcoWater Systems dealer.

If I need a part replaced after the factory warranty expires, is the replacement part warranted?

Yes, EcoWater Systems LLC warrants FACTORY REPAIRS as well as all REPLACEMENT PARTS for a period of 90 DAYS. This warranty does not include normal shipping, installation or service charges.

Are any additional warranties available?

We are pleased to say, YES! EcoWater Systems LLC sells an EXTENDED, PARTS ONLY WARRANTY for the ELECTRONICS portion of your product. This warranty is called the "Perfect Ten" and extends the three year warranty on the electronic FACE-PLATE, WIRING HARNESS, DRIVE MOTOR, POWER SUPPLY, POWER CORD, SENSOR HOUSING, and MICRO SWITCHES to a total of TEN YEARS from the date of original installation. Your local dealer will provide details regarding this warranty or will refer you to the factory for additional information. Should your local dealer not offer this warranty, you may contact the factory for additional information.* This guarantee may be subject to normal shipping and installation or service charges.

General Provisions

The above warranties are effective provided the water conditioner is operated at water pressures not exceeding 125 psi, and at water temperatures not exceeding 120°F; provided further that the water conditioner is not subject to abuse, misuse, alteration, neglect, freezing, accident or negligence; and provided further that the water conditioner is not damaged as the result of any unusual force of nature such as, but not limited to, flood, hurricane, tornado or earthquake. EcoWater Systems LLC is excused if failure to perform its warranty obligations is the result of strikes, government regulation, materials shortages, or other circumstances beyond its control.

*THERE ARE NO WARRANTIES ON THE WATER CONDITIONER BEYOND THOSE SPECIFICALLY DESCRIBED ABOVE. ALL IMPLIED WARRANTIES, INCLUDING ANY IMPLIED WARRANTY OF MERCHANTABILITY OR OF FITNESS FOR A PARTICULAR PURPOSE, ARE DISCLAIMED TO THE EXTENT THEY MIGHT EXTEND BEYOND THE ABOVE PERIODS. THE SOLE OBLIGATION OF ECOWATER SYSTEMS LLC UNDER THESE WARRANTIES IS TO REPLACE OR REPAIR THE COMPONENT OR PART WHICH PROVES TO BE DEFECTIVE WITHIN THE SPECIFIED TIME PERIOD, AND ECOWATER IS NOT LIABLE FOR CONSEQUENTIAL OR INCIDENTAL DAMAGES. NO ECOWATER DEALER, AGENT, REPRESENTATIVE, OR OTHER PERSON IS AUTHORIZED TO EXTEND OR EXPAND THE WARRANTIES EXPRESSLY DESCRIBED ABOVE.

Some states do not allow limitations on how long an implied warranty lasts or exclusions or limitations of incidental or consequential damage, so the limitations and exclusions in this warranty may not apply to you. This warranty gives you specific legal rights, and you may have other rights which vary from state to state. This warranty applies to consumer-owned installations only.